



Global manufacturing and trading company S.L
Pol. Ind. Los vientos
Calle Alisio, parcela nº4
46119 Náquera · Valencia · Spain
mantrailuminacion.com
info@mantraco.org

mAntra

mAntra

TÉCNICO

VII

TÉCNICO

MANTRA EN EL MUNDO

MANTRA AROUND THE WORLD





David Villalba

EN_

Mantra works with a very diverse team of freelance designers, specialized in different branches of design.

They are a group of highly qualified professionals experience in the lighting sector, who contribute with original solutions in the development of new concepts; they also participate actively in the whole product development process, from the initial draft to the lasted finishing details

This wide variety of styles that our designers offer have a direct impact on our catalogues, which are made up of ideas that are adapted to any type of lighting need.

Besides, we take pride in having a great relationship with them, which goes beyond the professional link. We truly rely on their capability and work methods, which have provided, such innovative and stylish collections so far.



Carlos Santolaria



José Ignacio Ballester

FR_

Mantra collabore avec une équipe de dessinateurs externes très diverse, spécialisés dans différentes branches dans le monde du design.

Des professionnels avec une grande expérience dans le secteur de l'illumination, qui apportent des solutions innovatrices au développement de nouveaux concepts, et participent dans tous les processus de fabrication du produit, depuis le brouillon jusqu'à la conception du produit final.

Cette grande variété de styles influence directement notre catalogue, qui est composé de solutions qui s'adaptent à tous les styles ou besoins dans le monde de l'illumination.

Notre relation avec l'équipe de designers va plus loin que le contact professionnel, nous avons confiance sur leur savoir-faire, et leur méthodes de travail qui nous apporte fraîcheur et innovation, pour chacune de nos collections.

JW design



Wilfried Buelacher



Jackie Luo



Santiago Sevillano

ITL_

Mantra collabora con un team di designer esterni molto diversi, specializzati in varie branche nel mondo del design.

Professionisti con esperienza nel settore dell'illuminazione che forniscono soluzioni innovative nello sviluppo di nuovi concetti, partecipando a tutti i processi di sviluppo del prodotto, dallo schizzo iniziale alla concezione del prodotto finale.

Questa ampia varietà di stili che ci offre influisce direttamente sul nostro catalogo, che è composto da soluzioni che si adattano a qualsiasi tipo di stile o esigenza nel mondo dell'illuminazione.

Il nostro trattamento con i designer va oltre un semplice trattamento professionale, confidiamo pienamente nel loro buon lavoro e nei loro metodi di lavoro che ci danno freschezza e innovazione in ciascuna delle nostre collezioni.



Hugo Tejada

ESP_

Mantra colabora con un equipo de diseñadores externos muy diverso, especializados en diversas ramas dentro del mundo del diseño.

Profesionales con experiencia en el sector de la iluminación que aportan soluciones novedosas en el desarrollo de nuevos conceptos, participando en todos los procesos de desarrollo del producto, desde el boceto inicial hasta la concepción del producto final.

Esta gran variedad de estilos que nos ofrecen incide directamente en nuestro catálogo, el cual está compuesto por soluciones que se adaptan a cualquier tipo de estilo o necesidad dentro del mundo de la iluminación.

Nuestro trato con los diseñadores va más allá de un mero trato profesional, confiamos plenamente en su buen hacer y en sus métodos de trabajo que nos aporta frescura e innovación en cada una de nuestras colecciones.

INTERIOR/INDOOR

Aplique/Wall light

New



ALTEA 26 ASIMETRIC 50 BOAVISTA 64 BORA BORA 76 CAÍCOS 74 CAYMAN 62 DURBAN 46



EYES 42 FUJI 20 FUERTEVENTURA 54 GOA 40 GOCOVA 66 HANOK 30 IOS 184



KUBICK 36 LUPPI 34 MORNE 48 MURAL 82 NELSON 18 ORION 22 PARACURU 84



PREA 72 SAL 58 TAHITI XL 24 TARIFA 70 TARIFA II 68 TORONTO 16 TOBAGO 28



TORCH 56 VENUS 44 ZANZIBAR 52

INTERIOR/INDOOR

Plafón/Ceiling

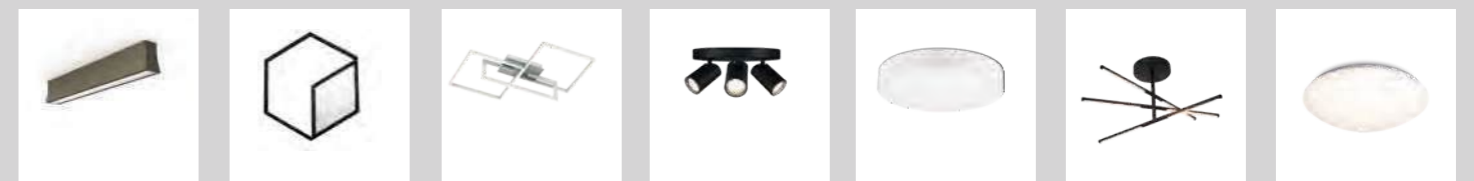

HANOK 88 KUBICK 38 MURAL 94 SAL 90 SAONA SUPERFICIE 98 TORCH 92 ZERO E27 96

Colgante/Pendant



ARUBA 150 BOLONIA 106 CLIFTON 122 FLORÓN EMPOTRABLE 152 GRUISSAN 108 GRUISSAN 110 GRUISSAN 112

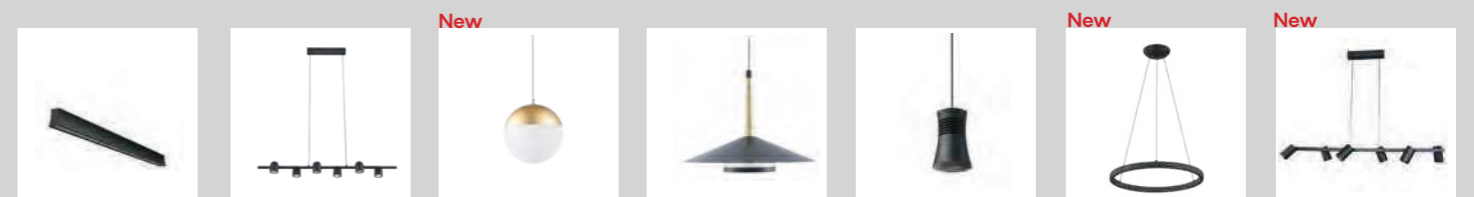

HANOK 126 IOS 124 KILDA 114 ORION 138 PAGODA 134 RIUMAR 102 SAL 120



TORCH 118 TORCH 148

INTERIOR/INDOOR

Sobremesa/Table lamp



EYES 160
MURAL 164
SAL 156
TORCH 162

Pie de salón/Floor lamp

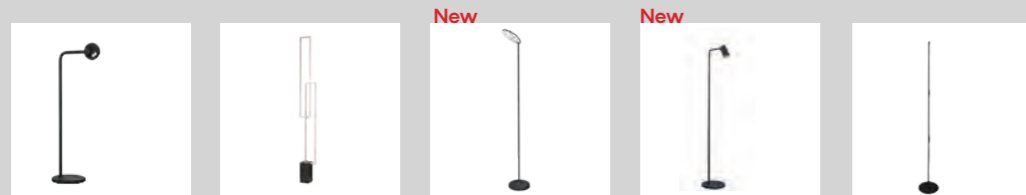

EYES 170
MURAL 174
NASSAU 166
SAL 168
TORCH 172

Foco Superficie/Spotlight



ARUBA 188
ARUBA 190
COLUMBRETES 192
GLACIAR 182
GOWER 186
IOS 184
MAGNETO 48W 200



MAGNETO 48W 202
MAGNETO 48W 204
MAGNETO 48W 206
MAGNETO 48W 210
SAL 180
SPLIT 178

Carril trifásico/Triphasic rail



ARUBA 236
CARRILES-TRACKS 246
CRETA 224
FIJI 240
ÍPSILON 230
ITACA 228
PAGODA 232
SAL 238

INTERIOR/INDOOR

Empotrable/Recessed

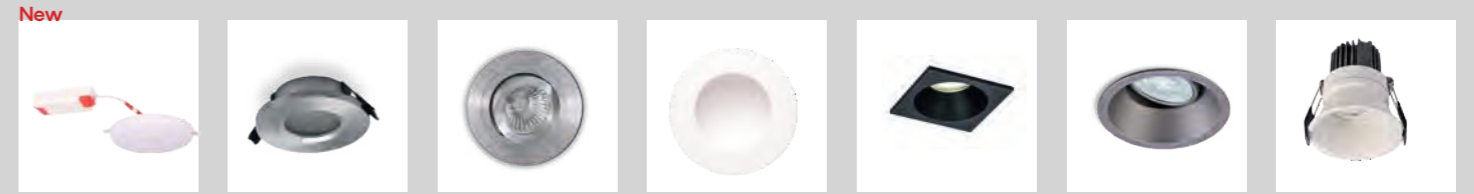

ALGARVE 256
ATLANTIS 314
BÁSICO GU10 292
CABRERA 258
COMFORT IP 315
COMFORT GU10 296
FORMENTERA 276



GARDA 280
GUINCHO 304
GUINCHO GU10 290
GRACIOSA 265
HURGADA 302
KIEL 308
LAGOS 288

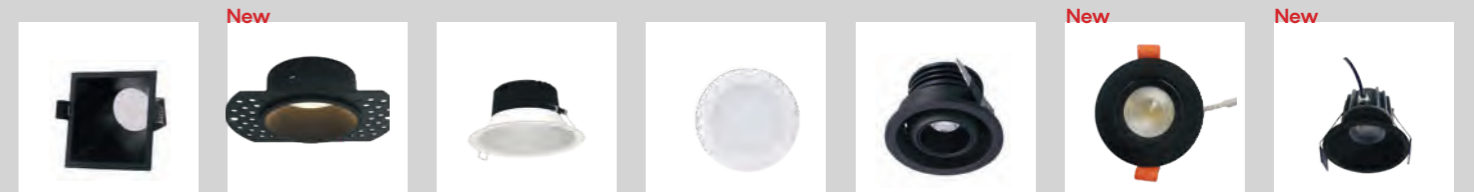

LAMBORJINI 298
LANCES 286
MEDANO 264
METACRILATO 306
NEPTUNO 282
PANAMA 274
ROMBOK 300



SAL 284
SAONA 260
SAONA 262
SUNSET 270
TAVIRA 310
TRIMASI 266

Campanas Led/Ufo bays Led



URANO 340
URANO 344

Tiras Led/Strip Leds



DRIVERS 329
PERFILES 322
SISTEMAS CONTROL 332
SKYLINE 338
TIRAS LED 318

EXTERIOR/OUTDOOR

Aplique/Wall light



New

ALPINE 402 ANDES 350 ARCS 356 BERET 354 BORA 390 CHAMONIX 404 COOPER 398



New

New

New

DAVOS 378 DAVOS XL 380 DAVOS DOUBLE 382 IGUAZÚ 372 KANDANCHÚ 376 LEVI 408 LOTUS 352



MAYA 360 MERIBEL 364 MERIBEL 394 POLINESIA 358 RUKA 362 SOCHI 388 SOLDEN 396



New

TAOS 406 TEJA 368 TRIAX 386 UTAH 392 VERBIER 420 VOLCANO 370

EXTERIOR/OUTDOOR

Plafón exterior/Ceiling outdoor



New

BACHELOR 424 CHAMONIX 422 KANDANCHÚ 412 LEVI 426 MAYA 416 UTAH 418 VERBIER 420



VOLCANO 414

Colgantes exterior/Pendant outdoor

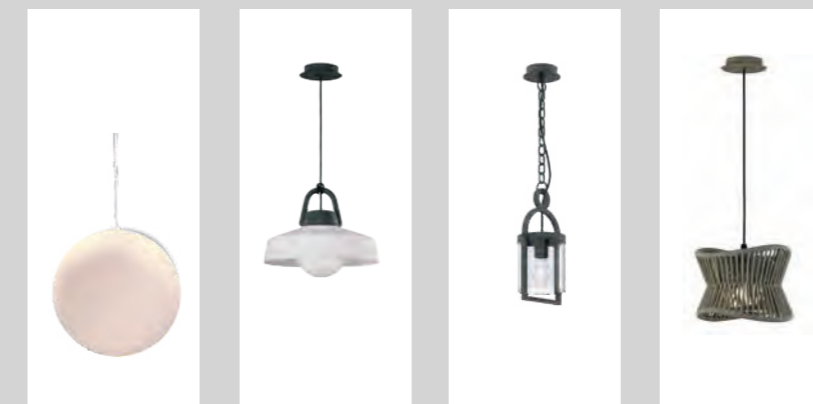

AVORIAZ 440 KINKÉ 434 MAYA 438 POLINESIA 430

EXTERIOR/OUTDOOR

Sobremesa exterior portátil/Portable outdoor table lamp

Lámpara de suelo exterior/Outdoor floor lamp



K4
450

K5
448

RELAX
446

RELAX
444



FLAME
452

Sobremuro exterior/Over wall lamp



MAYA
460

MERIBEL
456

MERIBEL
458

RUKA
464

Señalizadores-Step wall lights



ASPEN
492

ASPEN
490

BAKER
486

BAKER
488

Accesorios/Accessories



CONEXIÓN IP68
494

PIQUETAS
495

DISCO
495

EXTERIOR/OUTDOOR

Lámparas de suelo/Outdoor ground lamps



ALPINE
468

CHEVALIER
466

CHICAGO
470

RUKA
464

New

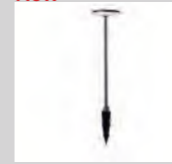

AKITA
474



AVORIAZ
478

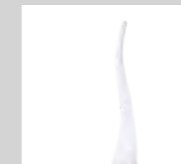

FLAME
480

New



NAGANO
472



QUEBEC
476



TAOS
482

BOMBILLAS/BULB

Bombillas/Bulb

New

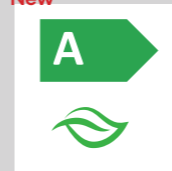

E14-E27 ECO
498

New

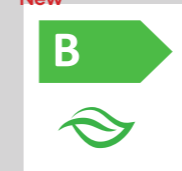

E14-E27 ECO
500



E14
502



E27
505



GX53
514



G9
515

New

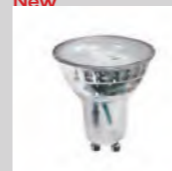

GU10
520

New



GU10 mini
516



G4
521

Apliques

Wall lights

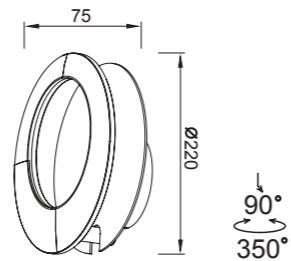
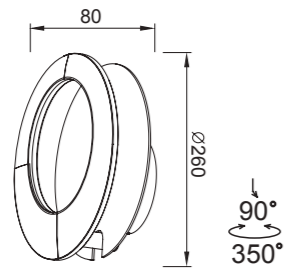
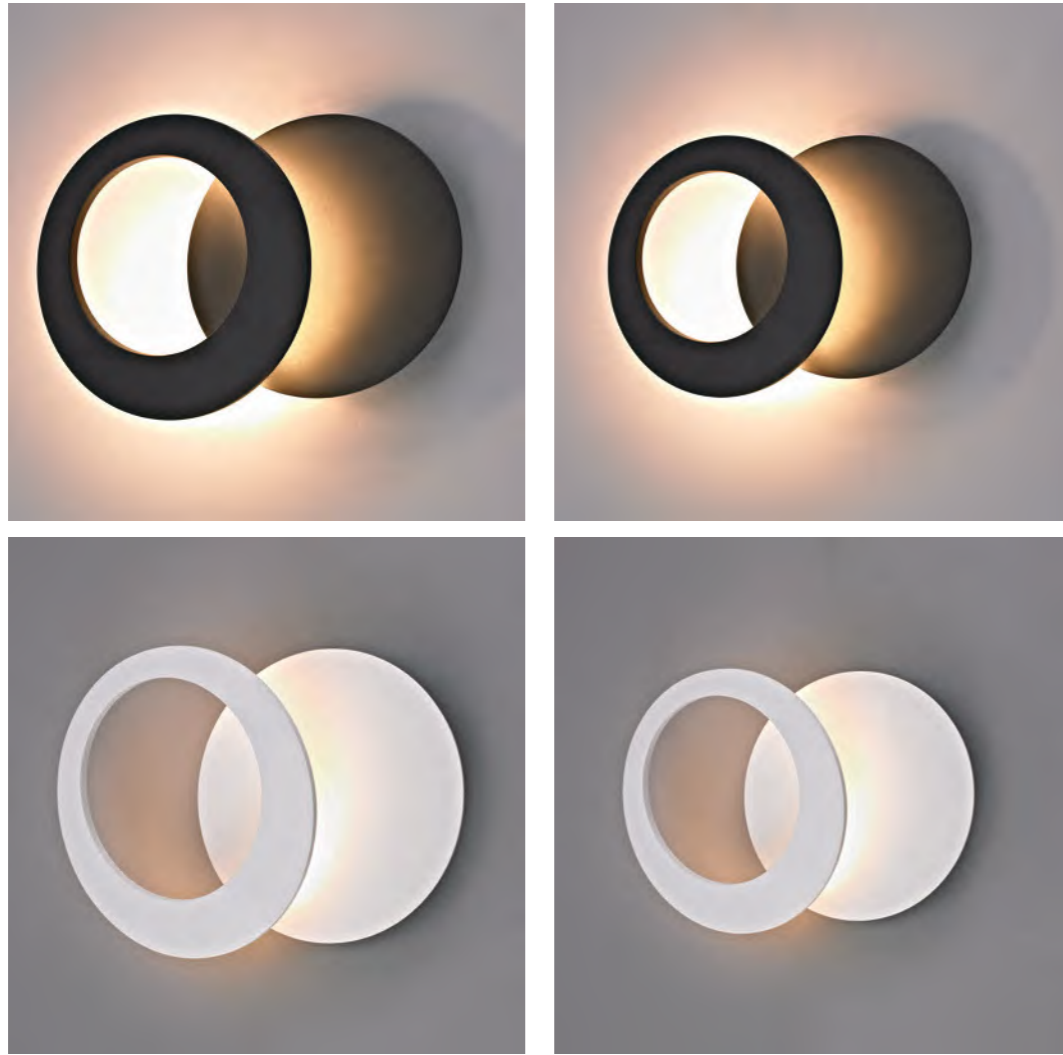

REFERENCE	K	LED WATT	LUMENS	FINISH
8461	3000K	10W	820lm	Blanco mate-Matt white
8462	3000K	10W	820lm	Negro mate-Matt black
8463	3000K	15W	1200lm	Blanco mate-Matt white
8464	3000K	15W	1200lm	Negro mate-Matt black
220-240V ~50/60Hz CRI≥ 80				Aluminio-Aluminium



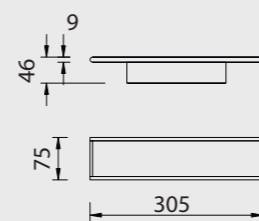
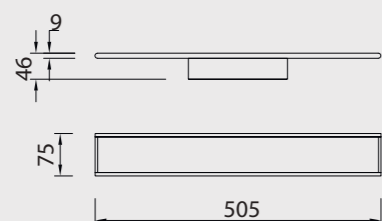
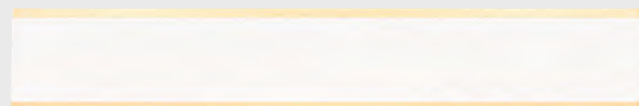
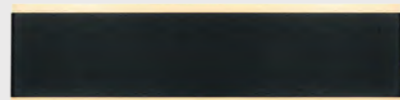
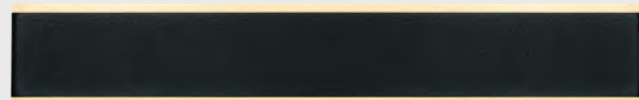

☐ CCT SWITCH
2700K-3200K-4000K



2700K



☐ CCT SWITCH
3200K



4000K



REFERENCE	CCT switch	LED WATT	LUMENS	FINISH
8494	2700K-3200K-4000K	16 W	1300lm	Blanco-White
8496	2700K-3200K-4000K	16 W	1300lm	Negro-Black
8495	2700K-3200K-4000K	24 W	1950lm	Blanco-White
8497	2700K-3200K-4000K	24 W	1950lm	Negro-Black
220-240V - 50/60Hz CRI:≥ 80				Aluminio-Aluminium

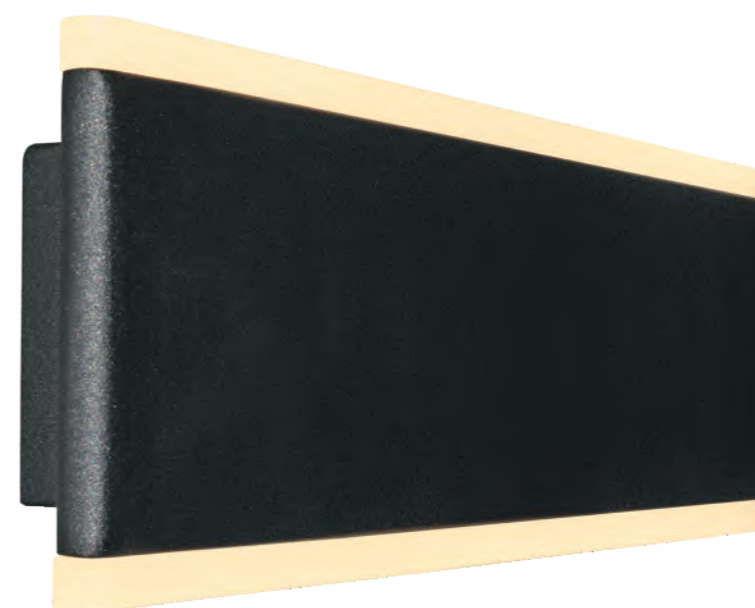

FUJI

by José Ignacio Ballester



14W

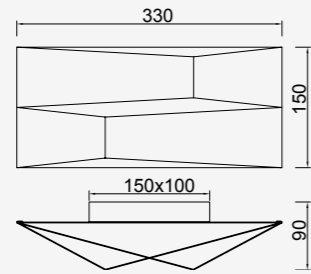

10W

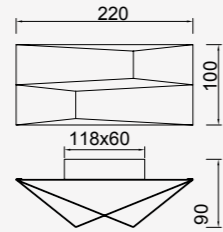

REFERENCE	K	LED WATT	LUMENS	FINISH
8156	3000K	10W	920lm	Blanco-White
8157	3000K	10W	920lm	Negro-Black
8158	3000K	14W	1250lm	Blanco-White
8159	3000K	14W	1250lm	Negro-Black
220-240V~ 50/60Hz CRI:≥ 80				Aluminio-Aluminium

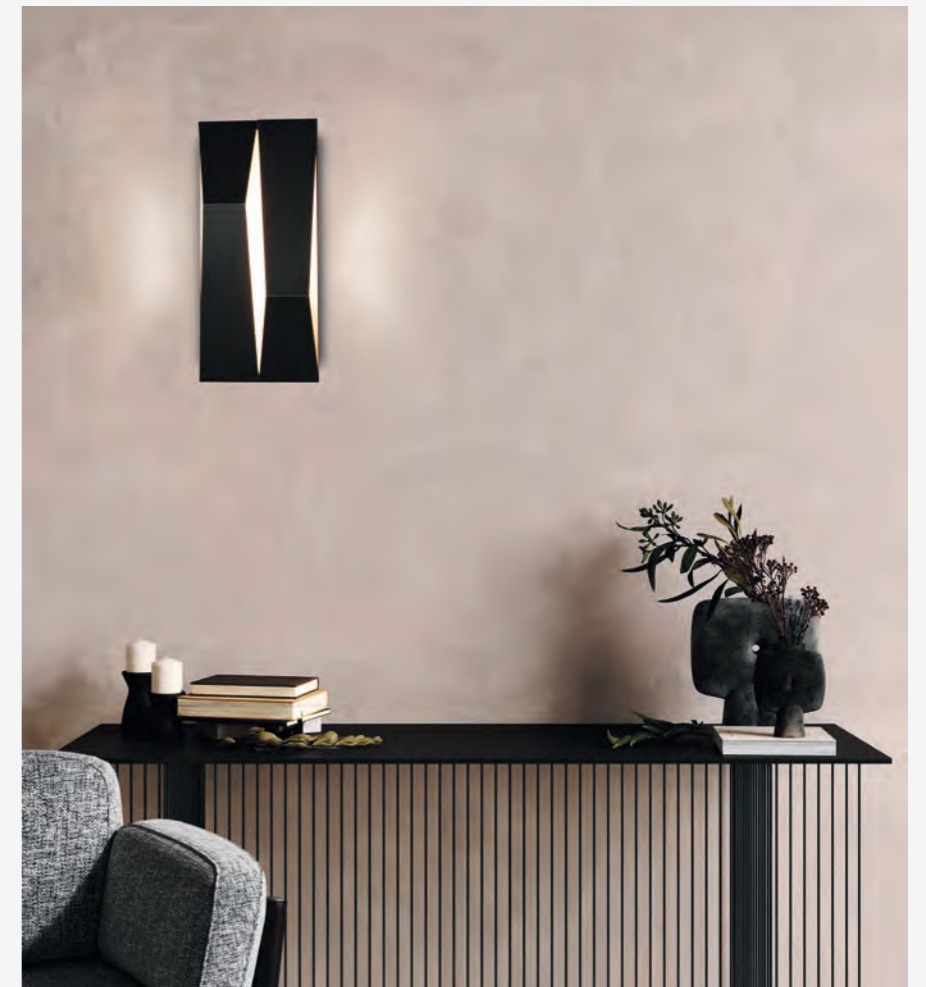

ORION

by Hugo Tejada

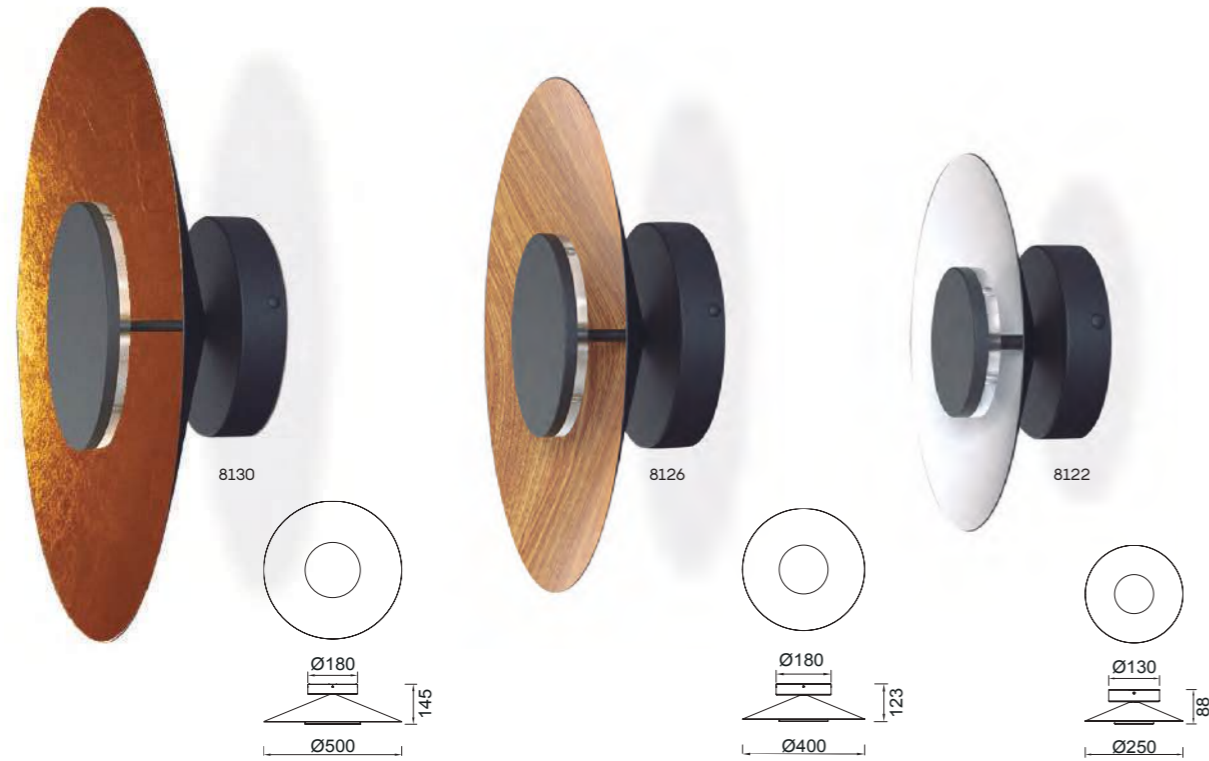

REFERENCE	K	LED WATT	LUMENS	FINISH	SIZES
8122	3000K	8W	560lm	Negro+blanco-Black+white	ø250
8123	3000K	8W	560lm	Negro+Madera-Black+Wood	ø250
8124	3000K	8W	560lm	Negro+Pan oro-Black+Gold leaf	ø250
8125	3000K	20W	1400lm	Negro+blanco-Black+white	ø400
8126	3000K	20W	1400lm	Negro+Madera-Black+Wood	ø400
8127	3000K	20W	1400lm	Negro+Pan oro-Black+Gold leaf	ø400
8128	3000K	24W	1680lm	Negro+blanco-Black+white	ø500
8129	3000K	24W	1680lm	Negro+Madera-Black+Wood	ø500
8130	3000K	24W	1680lm	Negro+Pan oro-Black+Gold leaf	ø500

220-240V~ 50/60Hz CRI ≥80

Hierro/Acrílico-Iron/Acrylic

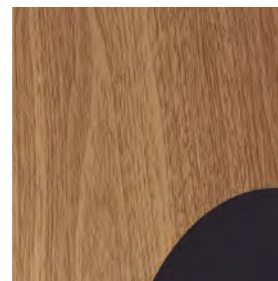

7475
pág. 138-146



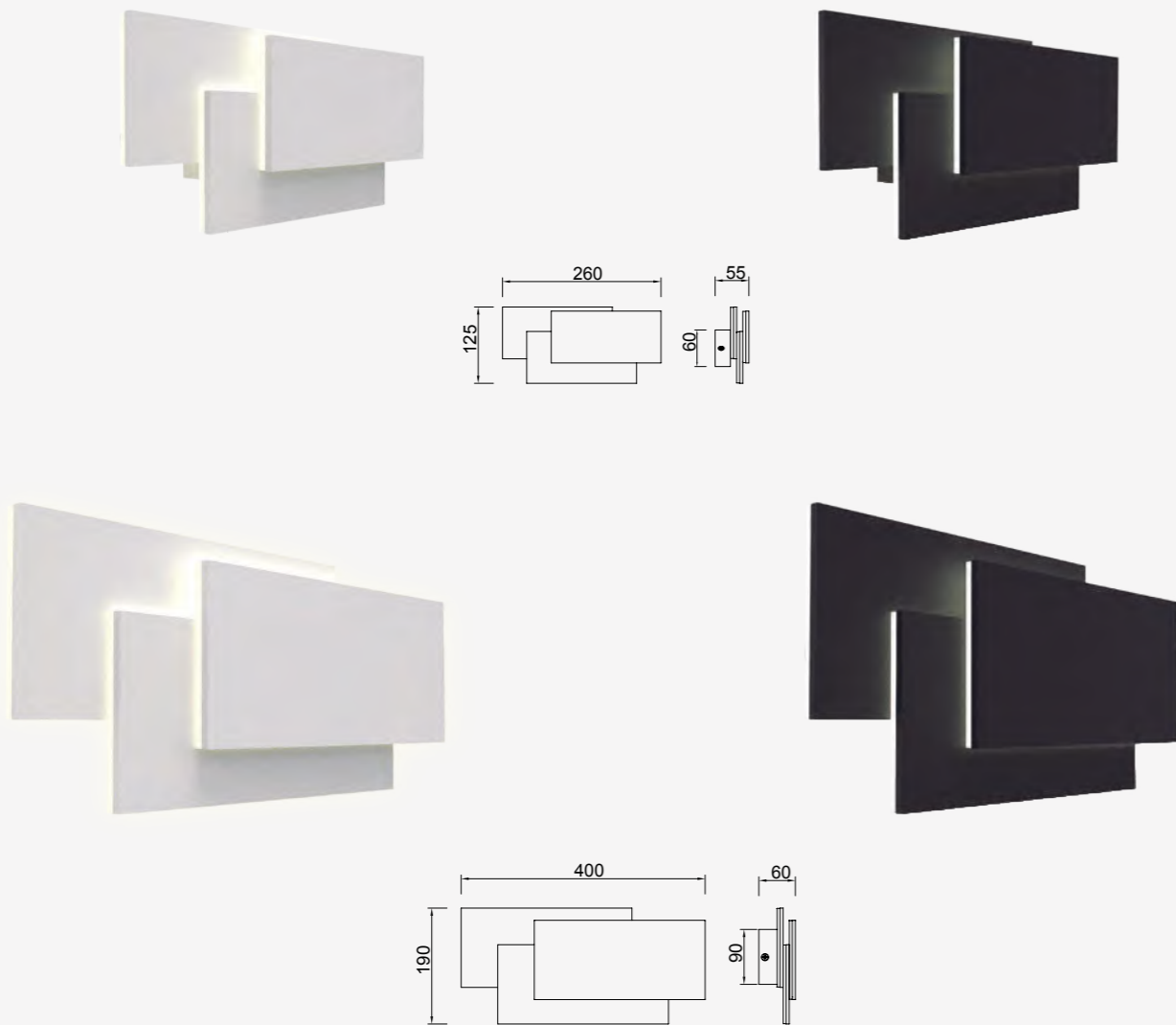

REFERENCE	K	LED WATT	LUMENS	FINISH
8089	3000K	12W	1080lm	Blanco-White
8090	3000K	12W	1080lm	Negro-Black
8087	3000K	36W	3240lm	Blanco-White
8088	3000K	36W	3240lm	Negro-Black

220-240V~ 50/60Hz CRI: ≥ 80 Aluminio/Acrílico - Aluminium/Acrylic

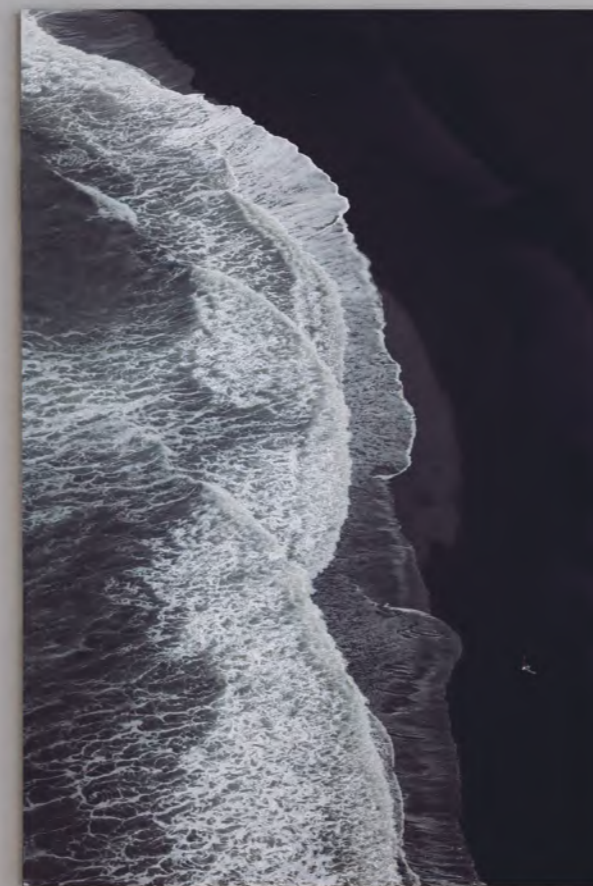

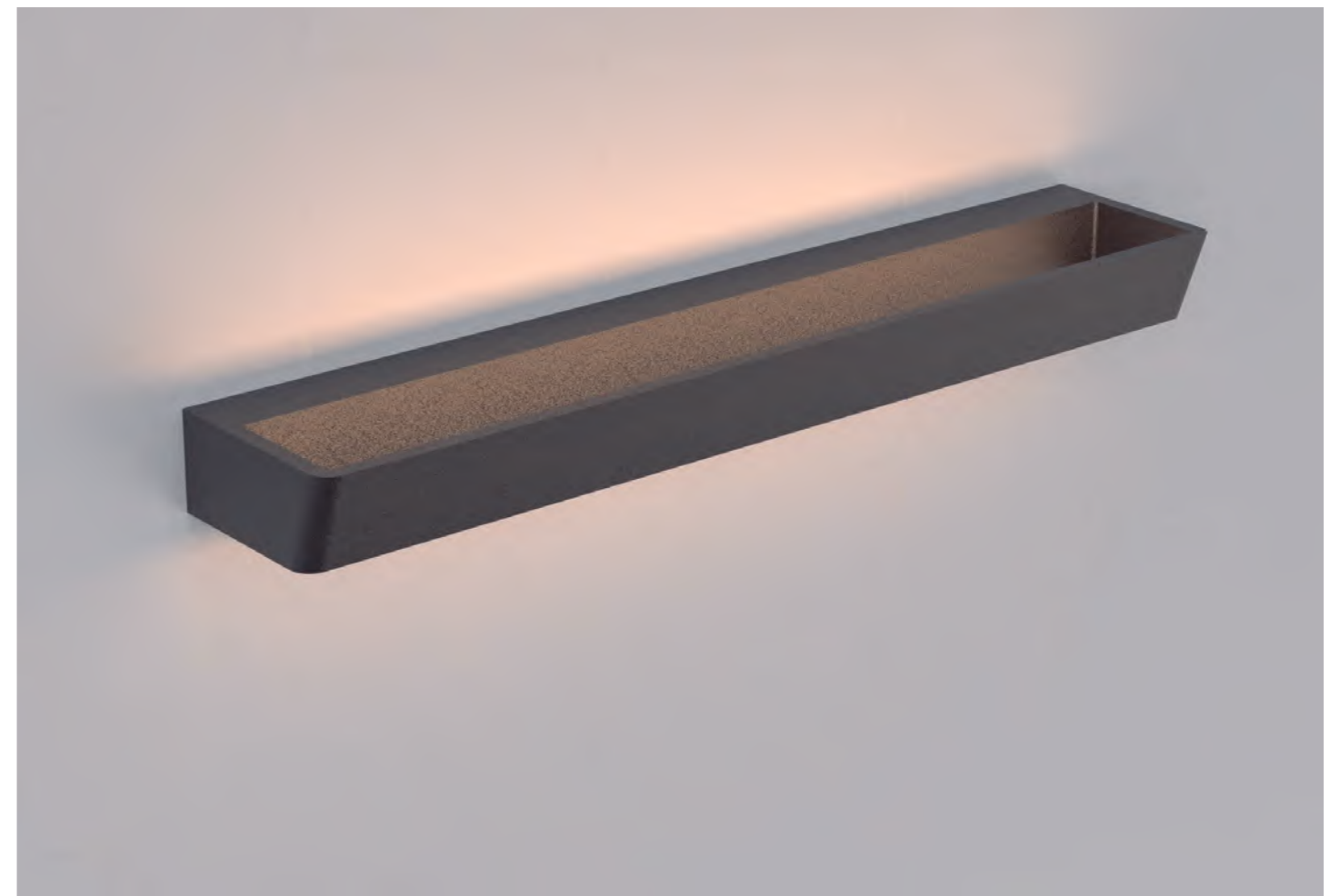
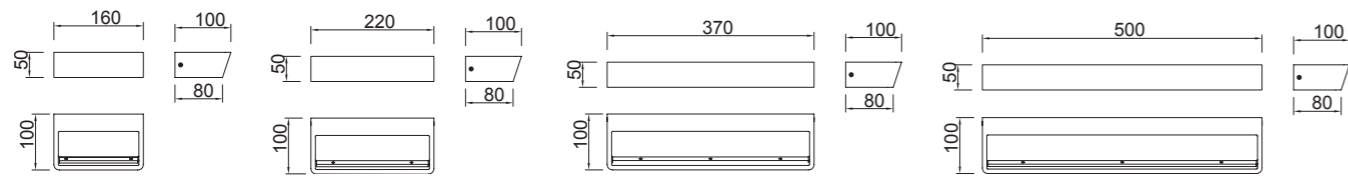

REFERENCE	K	LED WATT	LUMENS	FINISH
8094	3000K	15W	1200lm	Blanco arena-Sand white
New 8367	3000K	15W	1200lm	Negro arena-Sand black
8098	4000K	15W	1275lm	Blanco arena-Sand white
8093	3000K	21W	1680lm	Blanco arena-Sand white
New 8368	3000K	21W	1680lm	Negro arena-Sand black
8097	4000K	21W	1785lm	Blanco arena-Sand white
8092	3000K	30W	2400lm	Blanco arena-Sand white
New 8369	3000K	30W	2400lm	Negro arena-Sand black
8096	4000K	30W	2550lm	Blanco arena-Sand white
8091	3000K	40W	3200lm	Blanco arena-Sand white
New 8370	3000K	40W	3200lm	Negro arena-Sand black
8095	4000K	40W	3400lm	Blanco arena-Sand white
		220-240V~ 50/60Hz CRI:≥ 80		Aluminio/Acrílico-Aluminium/Acrylic



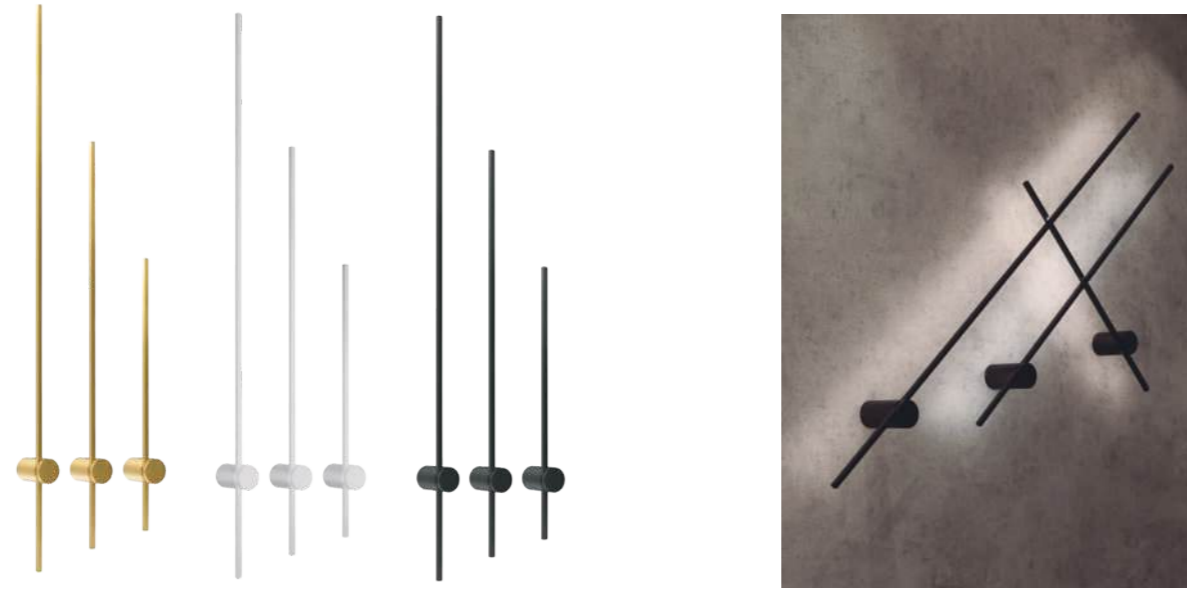

REFERENCE	K	LED WATT	LUMENS	FINISH
New 7865	3000K	7W	590lm	Oro-Gold
7910	3000K	7W	590lm	Blanco-White
7913	3000K	7W	590lm	Negro-Black
New 7866	3000K	9W	760lm	Oro-Gold
7911	3000K	9W	760lm	Blanco-White
7914	3000K	9W	760lm	Negro-Black
New 7867	3000K	12W	1010lm	Oro-Gold
7912	3000K	12W	1010lm	Blanco-White
7915	3000K	12W	1010lm	Negro-Black
220-240V~ 50/60Hz CRI:≥ 90				Aluminio-Aluminium

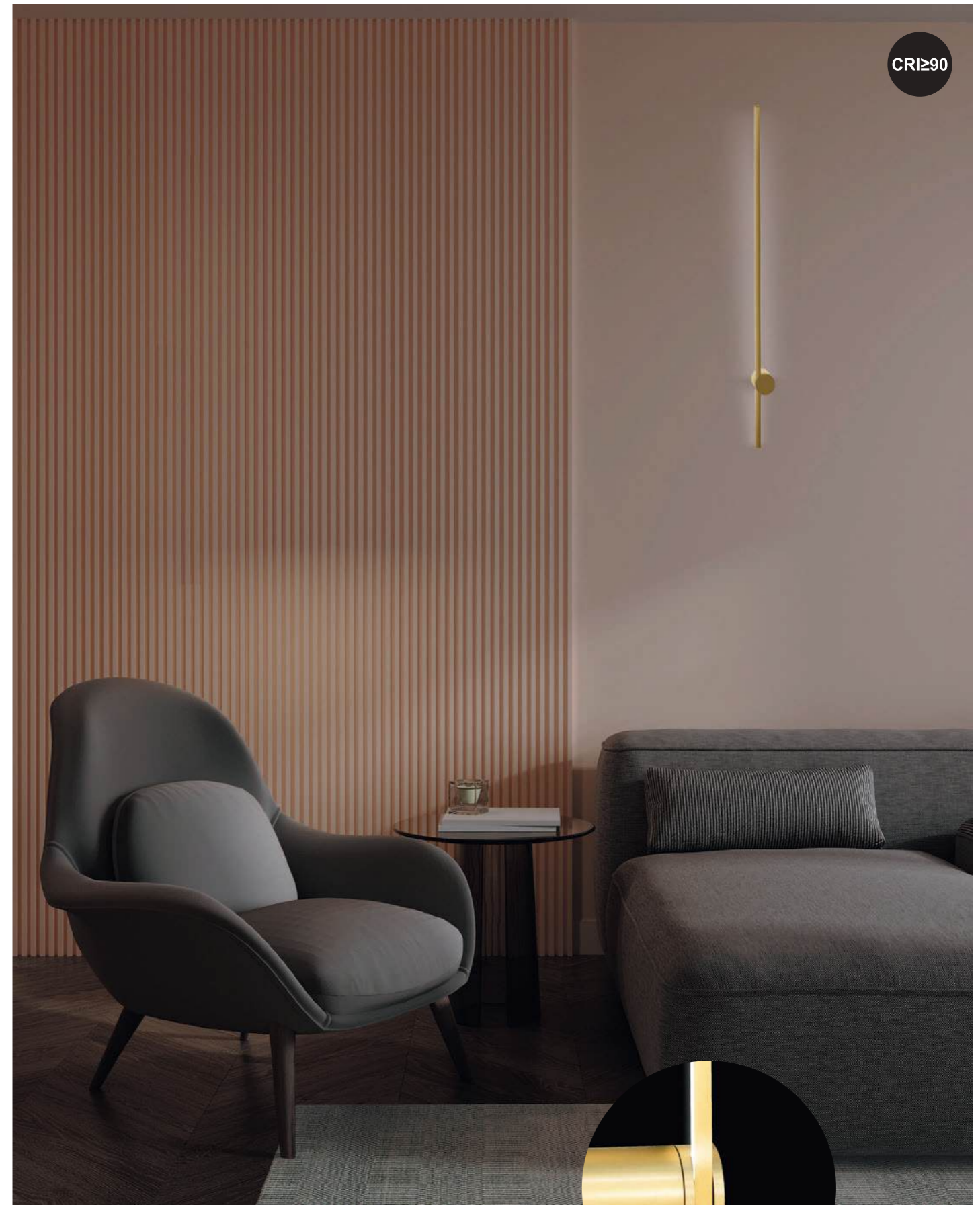
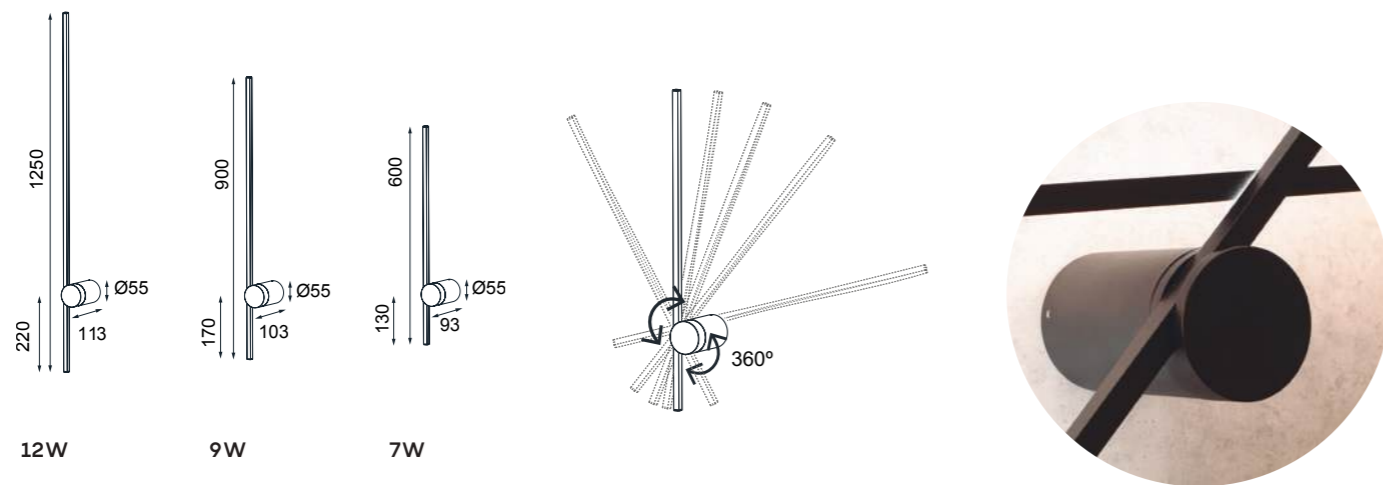

CRI≥90

CRI≥90





REFERENCE	K	LED WATT	LUMENS	FINISH
New 7865	3000K	7W	590lm	Oro-Gold
7910	3000K	7W	590lm	Blanco-White
7913	3000K	7W	590lm	Negro-Black
New 7866	3000K	9W	760lm	Oro-Gold
7911	3000K	9W	760lm	Blanco-White
7914	3000K	9W	760lm	Negro-Black
New 7867	3000K	12W	1010lm	Oro-Gold
7912	3000K	12W	1010lm	Blanco-White
7915	3000K	12W	1010lm	Negro-Black
220-240V~ 50/60Hz CRI:≥ 90				Aluminio-Aluminium

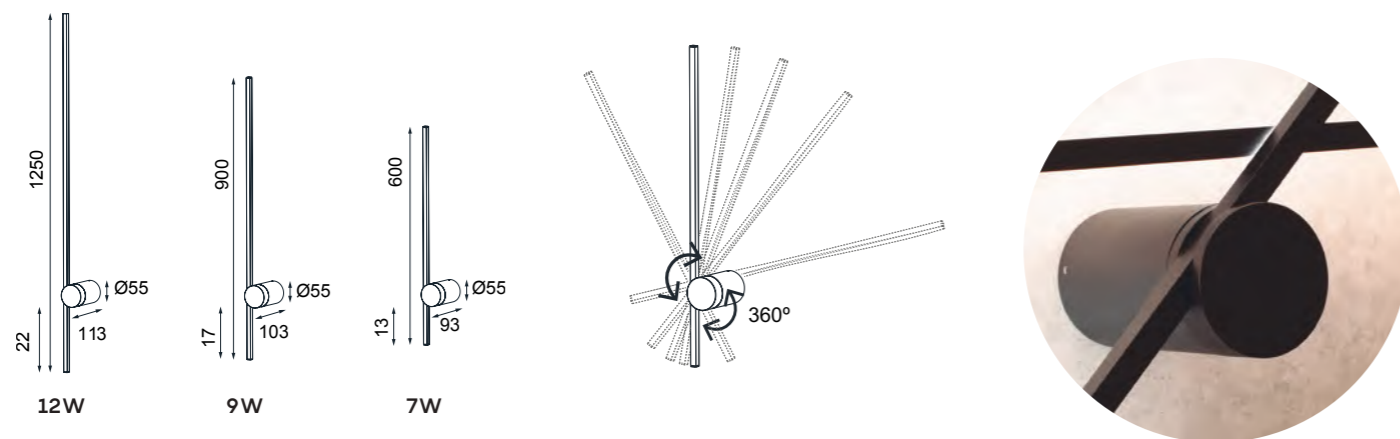

CRI≥90

CRI≥90

HANOK

by David Villalba

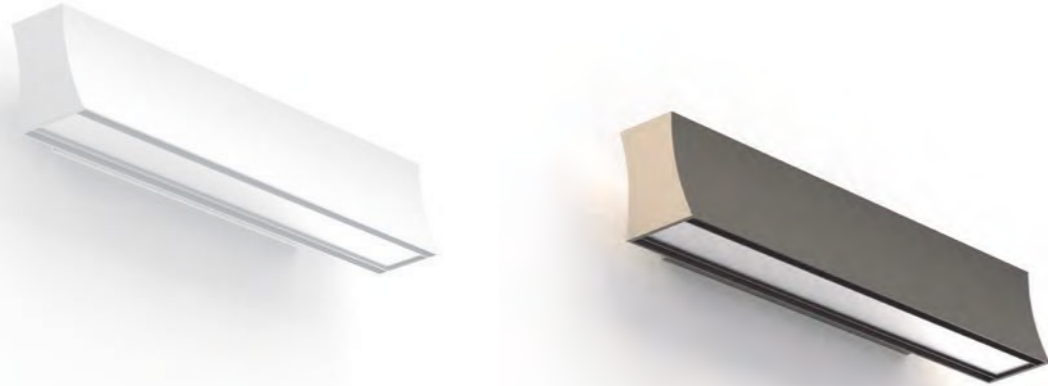

REFERENCE	K	LED WATT	LUMENS	FINISH
7774	3000K	14W	950lm	Blanco-White
7776	3000K	14W	950lm	Negro-Black
7778	3000K	14W	950lm	Arena-Sabbia
7775	4000K	14W	1000lm	Blanco-White
7777	4000K	14W	1000lm	Negro-Black
			220-240V~50/60Hz CRI:≥ 80	Aluminio-Aluminium

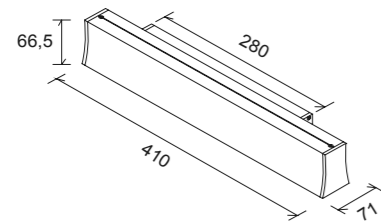

3000K 14W

4000K 14W

Luminous Intensity Distribution Curve

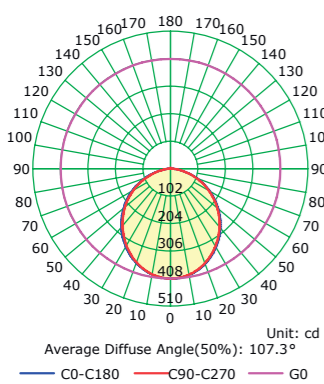

The Average Illuminance Effective Figure

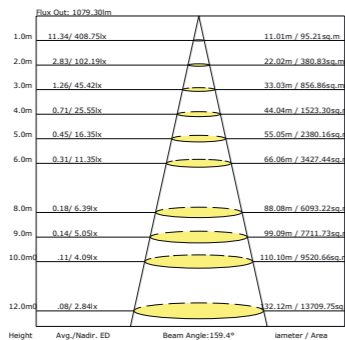

Luminous Intensity Distribution Curve

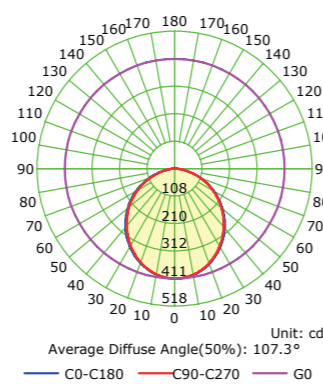

The Average Illuminance Effective Figure

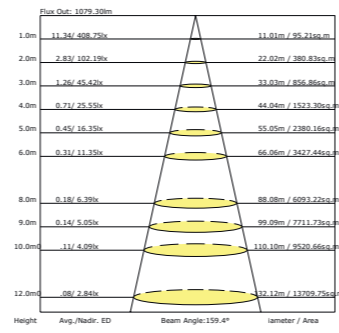

HANOK

by David Villalba

Apliques - Wall lights

Indoor



REFERENCE	K	LED WATT	LUMENS	FINISH
7770	3000K	38W	2850lm	Blanco-White
7772	3000K	38W	2850lm	Negro-Black
7771	4000K	38W	3000lm	Blanco-White
7773	4000K	38W	3000lm	Negro-Black
220-240V - 50/60Hz CRI: ≥ 80				Aluminio-Aluminium

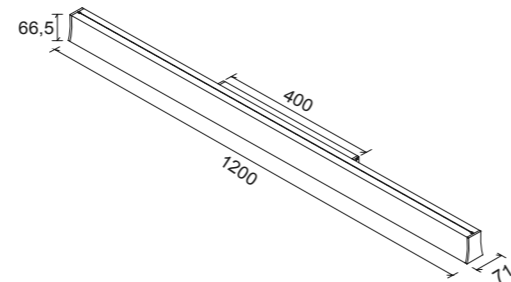
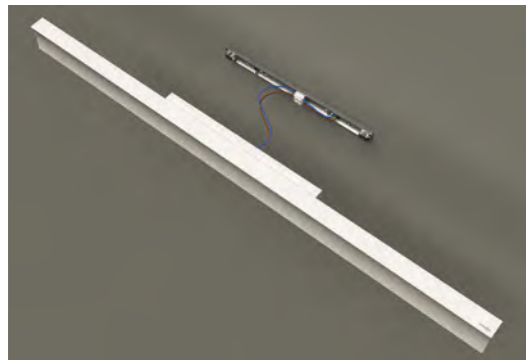

- UGR<19
- LED life / LED life 50,000 h
- ON / OFF 30,000
- garantía mantraco 5 años WARRANTY GARANTIA LED
- LED INCLUDED
- IP20

3000K 38W

4000K 38W

Luminous Intensity Distribution Curve

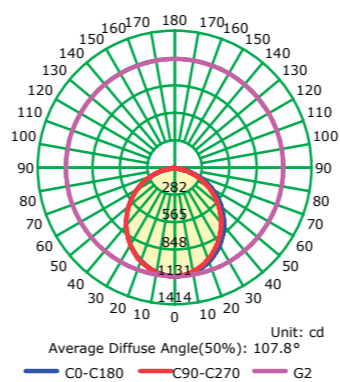

The Average Illuminance Effective Figure

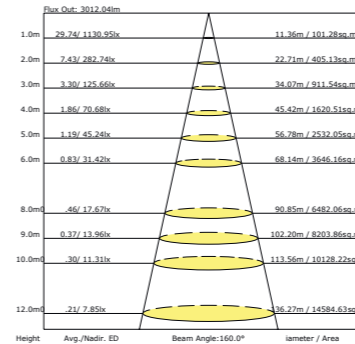

Luminous Intensity Distribution Curve

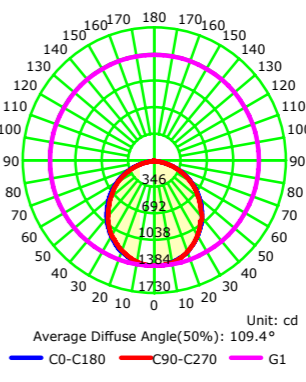

The Average Illuminance Effective Figure

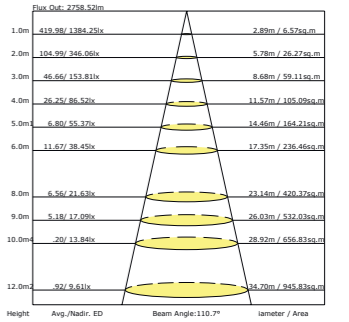

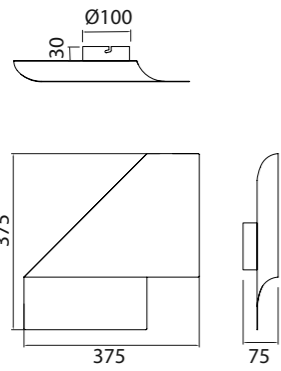
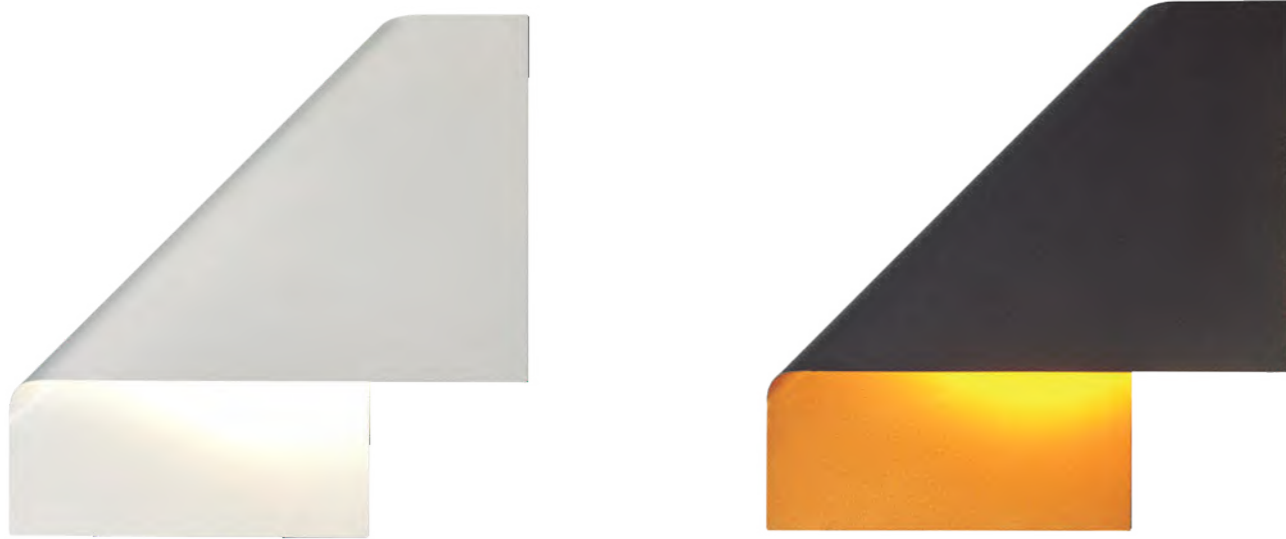

REFERENCE	BULB (No incl)	FINISH
7693	1L x GX53	Blanco-White
7694	1L x GX53	Negro-Black
7695	1L x GX53	Arena-Sabbia
	máx. 15W LED (No incl)	100-240V ~ 50/60Hz Metal-Metal

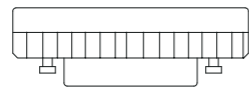

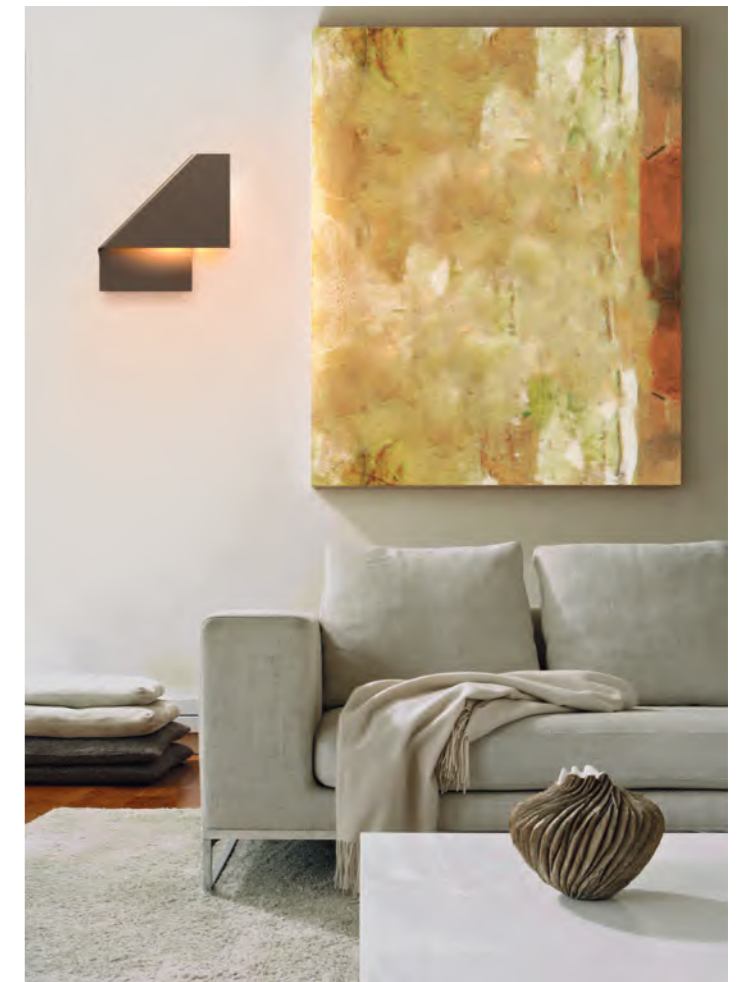

Bombillas recomendadas - Suggested bulbs

REFERENCE	Wattios LED	K	Lumens	Ángulo luz
R09224	9W	3000K	730lm	120°
R09225	9W	4000K	740lm	120°
R09248	12W	3000K	930lm	120°
R09249	12W	4000K	960lm	120°

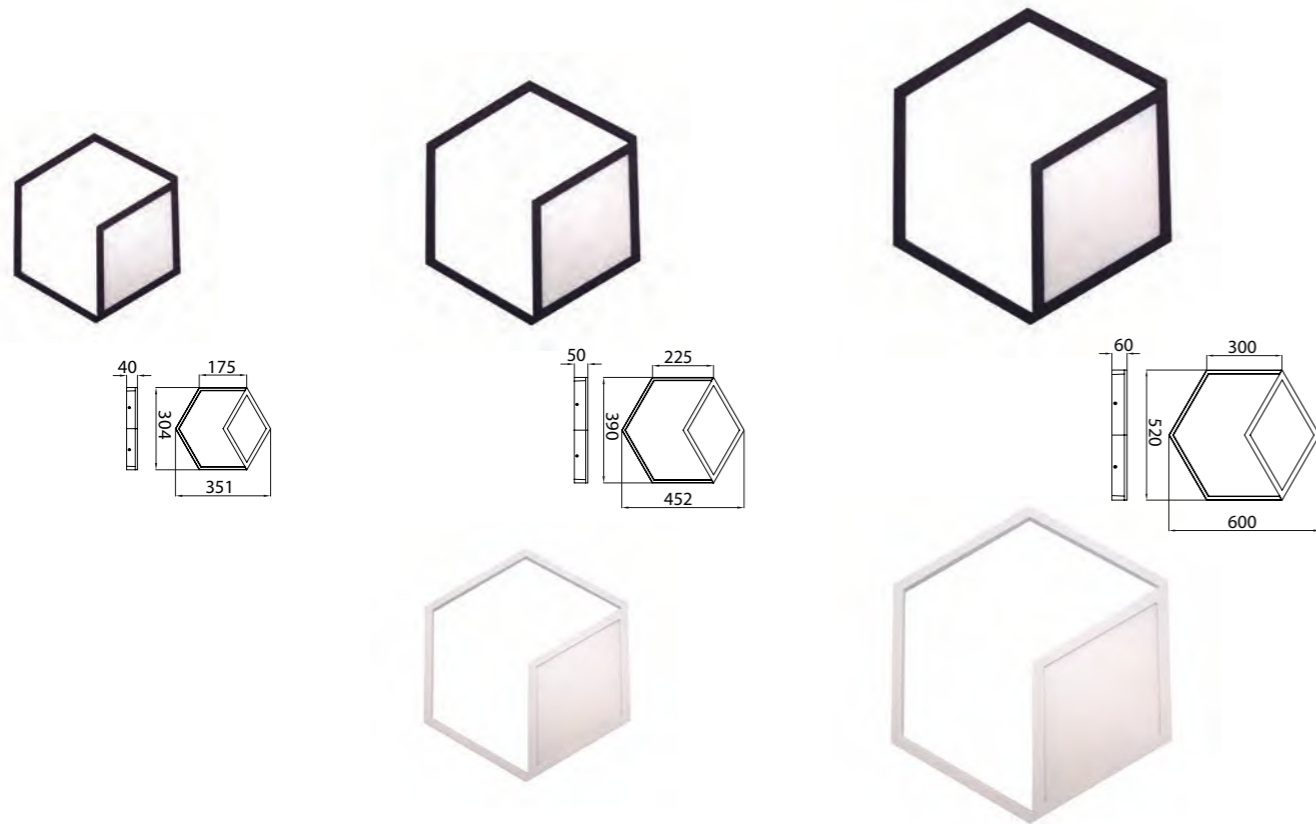



REFERENCE	K	LED WATT	LUMENS	FINISH	
7592	3000K	12W +14W	1630lm	Negro mate-Matt black	On-off
7593	3000K	12W +14W	1630lm	Negro mate-Matt black	Dimmable 
7594	3000K	13,5W + 20W	1870lm	Blanco mate-Matt white	On-off
7596	3000K	13,5W + 20W	1870lm	Negro mate-Matt black	On-off
7595	3000K	13,5W + 20W	1870lm	Blanco mate-Matt white	Dimmable 
7597	3000K	13,5W + 20W	1870lm	Negro mate-Matt black	Dimmable 
7760	3000K	18W+30W	2700lm	Blanco mate-Matt white	On-off
7762	3000K	18W+30W	2700lm	Negro mate-Matt black	On-off
7761	3000K	18W+30W	2700lm	Blanco mate-Matt white	Dimmable 
7763	3000K	18W+30W	2700lm	Negro mate-Matt black	Dimmable 
220-240V~50/60Hz CRI:≥ 80				Aluminio-Aluminium	



KUBICK

by José Ignacio Ballester

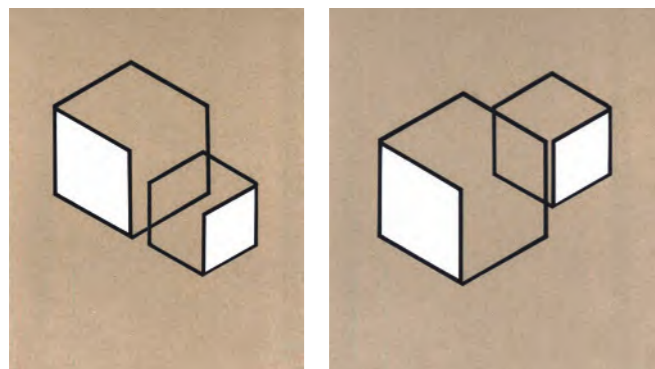
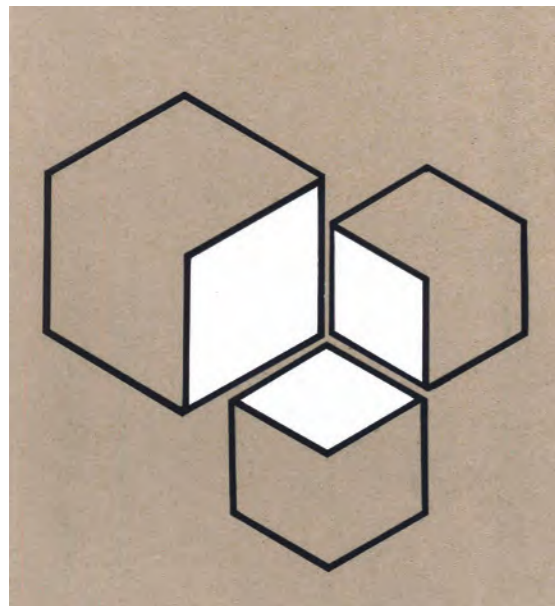
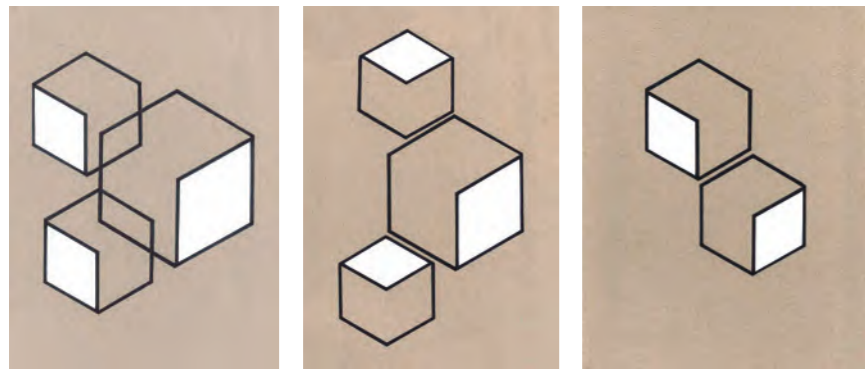
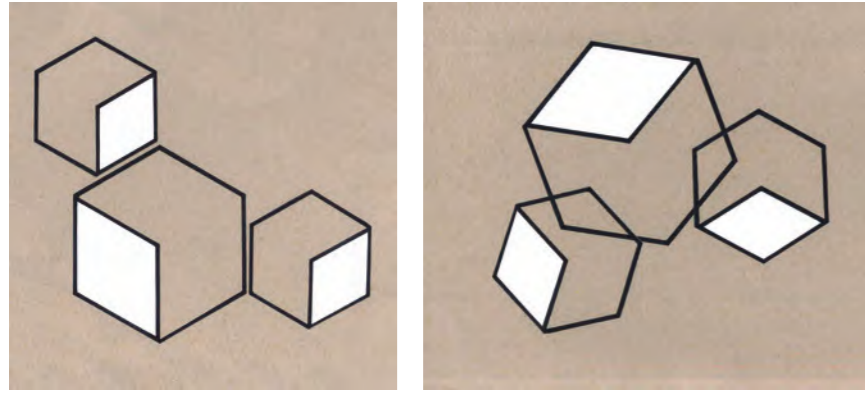

GOA

by José Ignacio Ballester

Indoor



REFERENCE	K	LED WATT	LUMENS	FINISH	
7720	3000K	7.5W	660lm	Blanco mate-Matt white	Con interruptor With switch
7721	3000K	7.5W	660lm	Negro mate-Matt black	Con interruptor With switch
				Aluminio-Aluminium	

220-240V-50/60Hz CRI:≥ 80

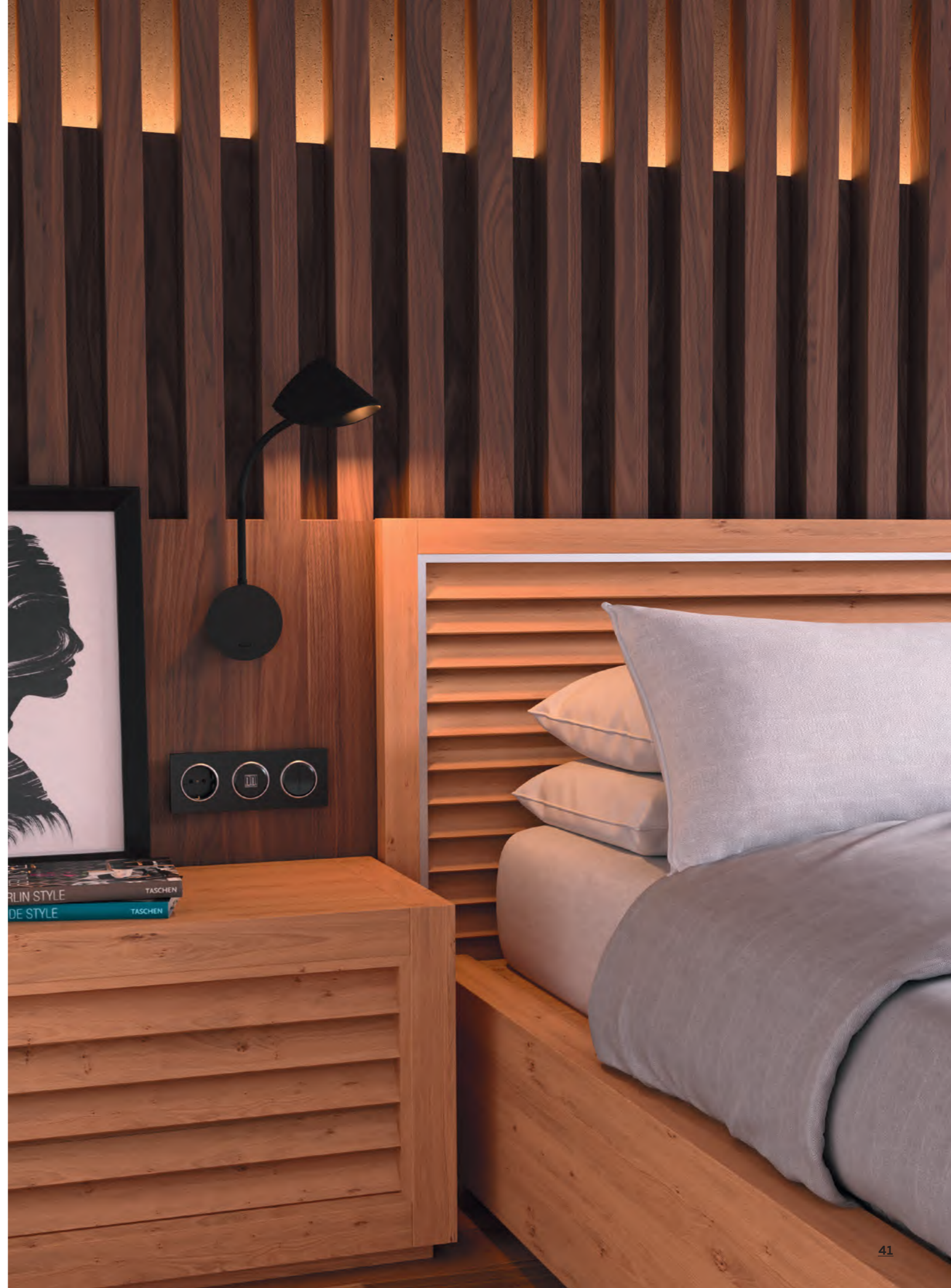
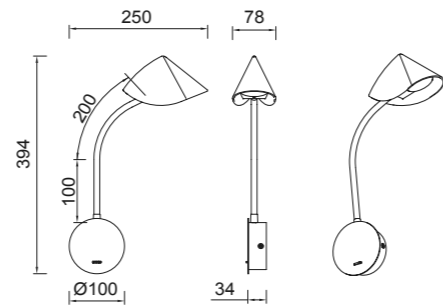

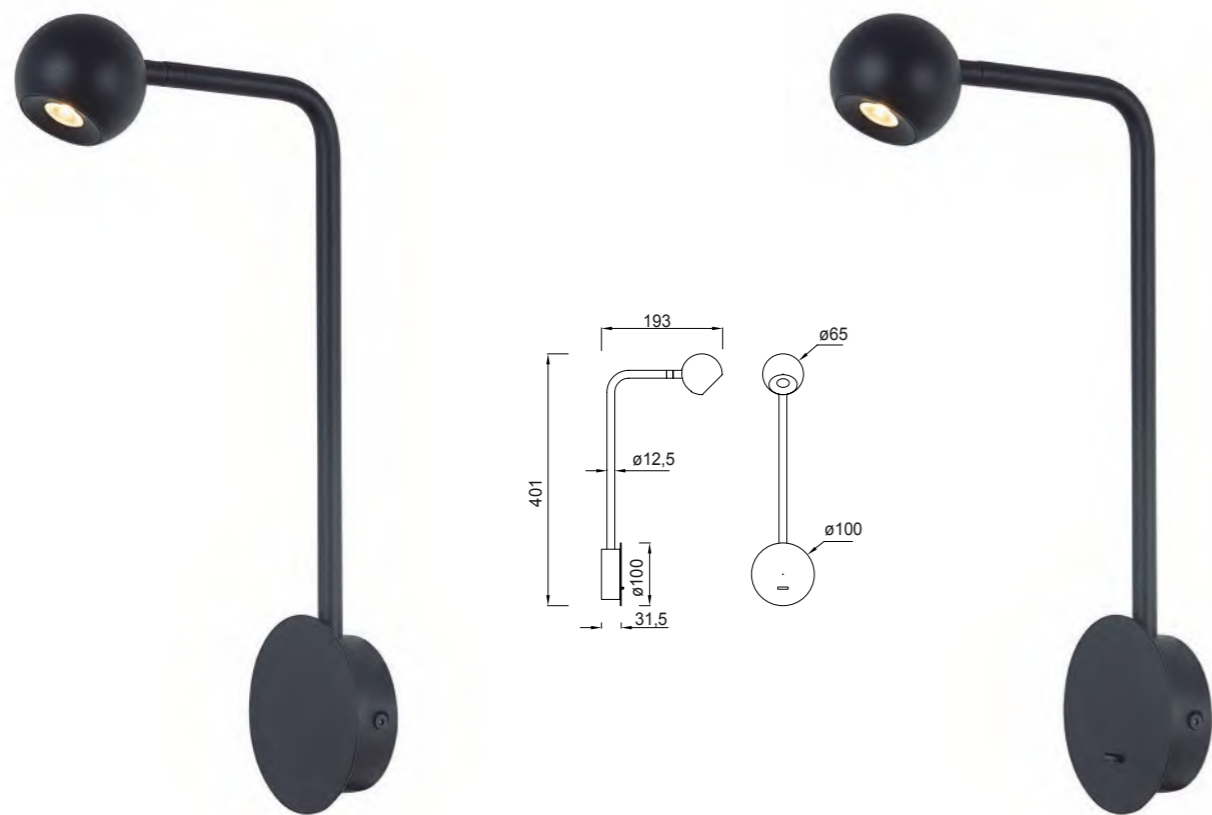

REFERENCE	K	LED WATT	LUMENS	FINISH	
7513	3000K	6W	390lm	Negro arena-Sand black	Sin interruptor No switch
7514	3000K	6W	390lm	Negro arena-Sand black	Con interruptor With switch
				Aluminio-Aluminium	

220-240V - 50/60Hz CRI: ≥ 80



VENUS

by Hugo Tejada

Indoor

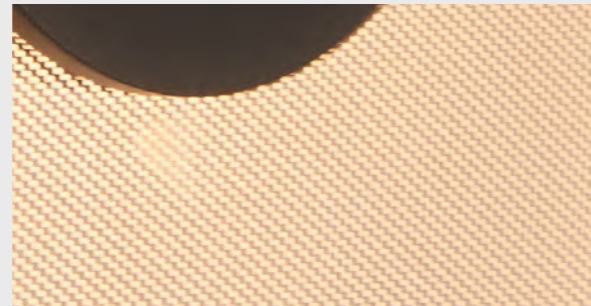
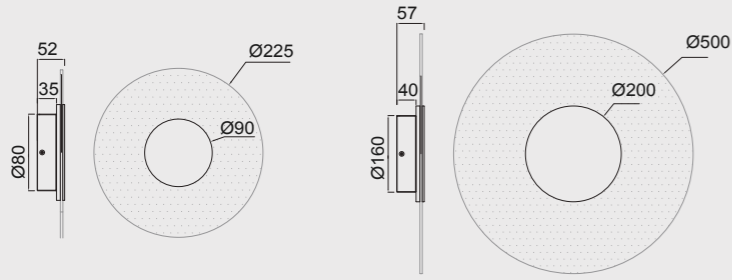

REFERENCE	K	LED WATT	LUMENS	FINISH	SIZES
8010	3000K	9W	780lm	Blanco-White	Ø225
8011	3000K	9W	780lm	Negro-Black	Ø225
8034	3000K	9W	780lm	Oro-Gold	Ø225
8012	3000K	18W	1440lm	Blanco-White	Ø500
8013	3000K	18W	1440lm	Negro-Black	Ø500
8035	3000K	18W	1440lm	Oro-Gold	Ø500

Registered N°007663331-0016 220-240V~50/60Hz CRI≥ 80 Aluminio/Acrílico-Aluminum/Acrylic

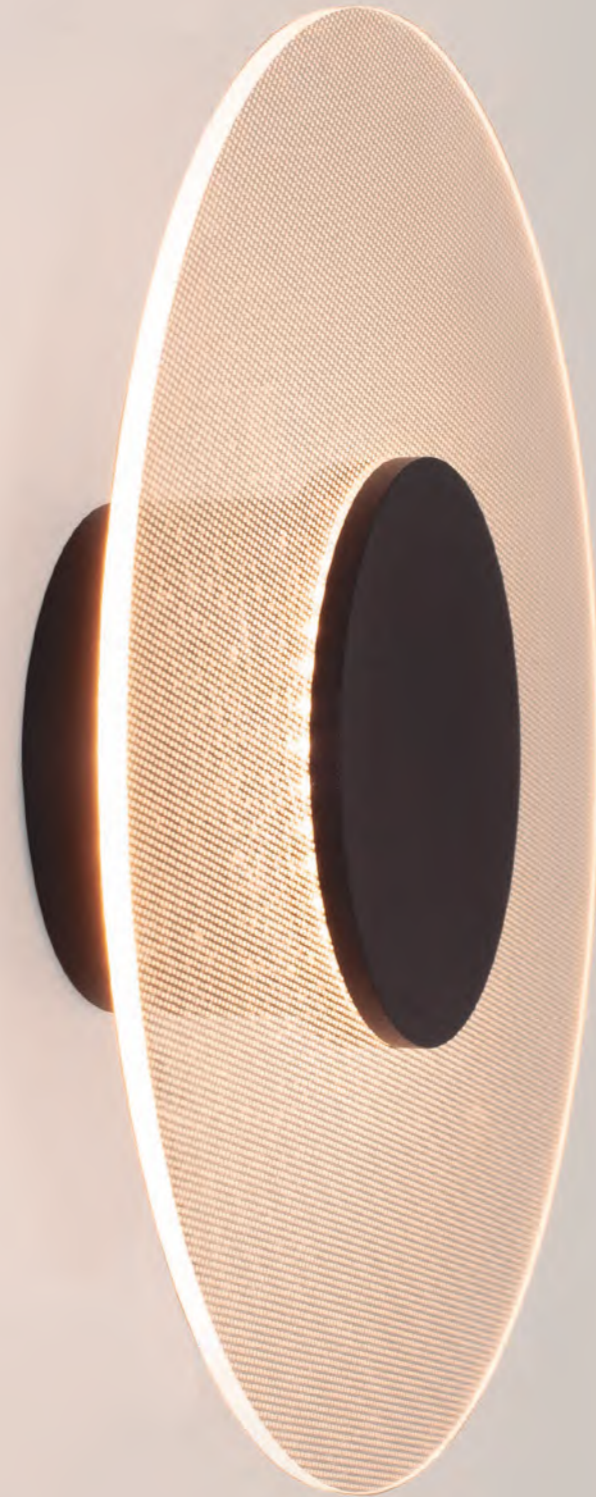

DRIVER
TUV

Registered N°007663331-0016



REFERENCE	K	LED WATT	LUMENS	FINISH
7197	3000K	10W	780lm	Blanco-White
7175	3000K	10W	780lm	Negro-Black
7198	3000K	20W	1550lm	Blanco-White
7176	3000K	20W	1550lm	Negro-Black
7199	3000K	30W	2300lm	Blanco-White
7177	3000K	30W	2300lm	Negro-Black
			220-240V ~50/60Hz CRI≥ 80	Aluminio-Aluminium

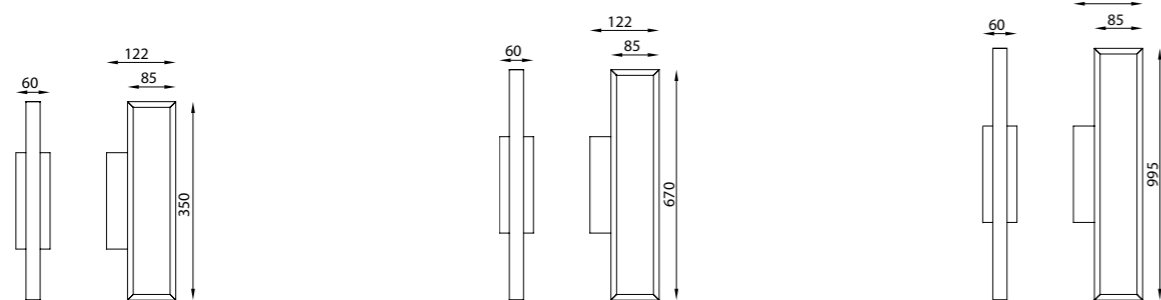



REFERENCE	K	LED WATT	LUMENS	FINISH
7482	4000K	12W	1080lm	Negro-Black
6760	4000K	12W	1080lm	Cromo-Chrome
6763	4000K	12W	1080lm	Blanco-White
7483	4000K	16W	1440lm	Negro-Black
6761	4000K	16W	1440lm	Cromo-Chrome
7480	4000K	16W	1440lm	Blanco-White
7484	4000K	20W	1800lm	Negro-Black
6762	4000K	20W	1800lm	Cromo-Chrome
7481	4000K	20W	1800lm	Blanco-White
220-240V~50/60Hz CRI≥ 80				Aluminio/Pc-Aluminium

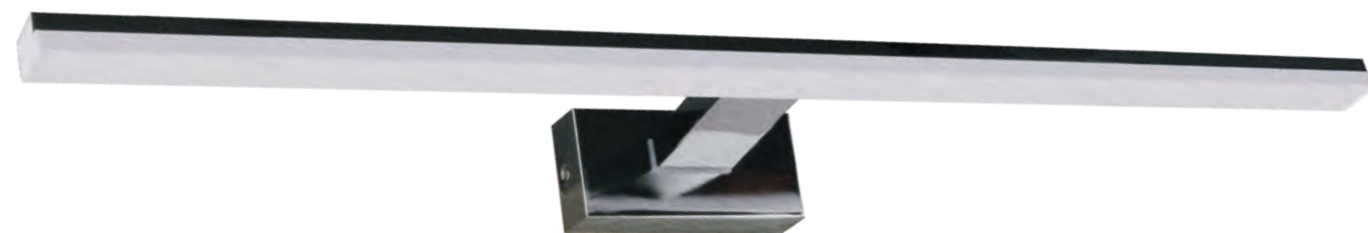
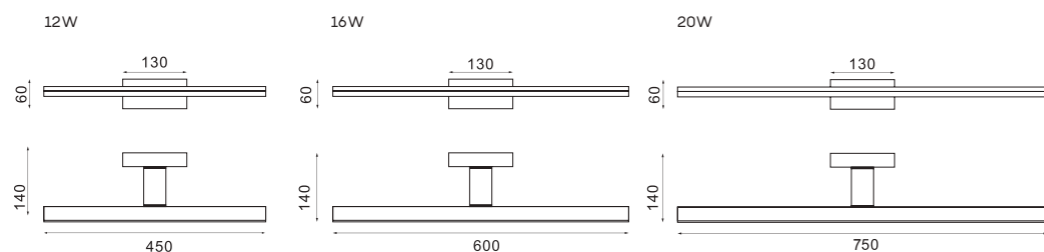

ASIMETRIC

by Santolaria & Lluscà

Apliques - Wall lights

Indoor

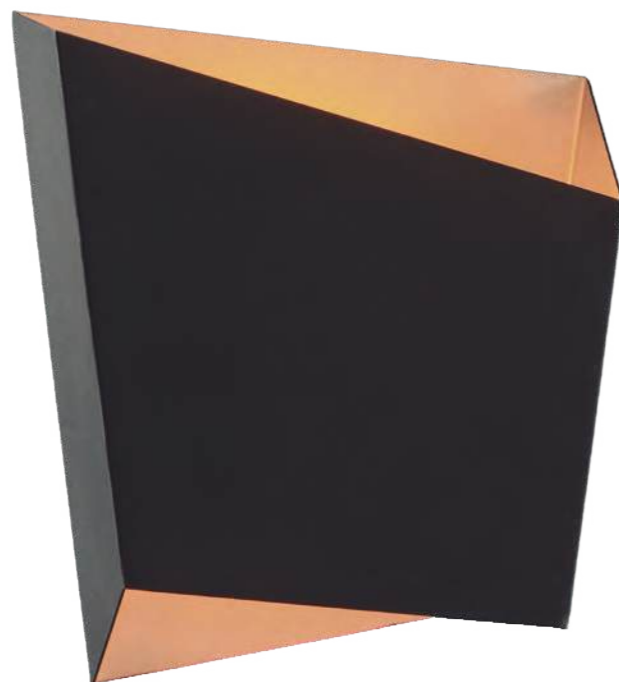



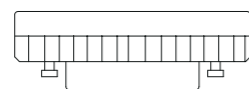
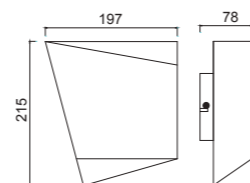

Registered N° 004721413-026

REFERENCE	BULB (No incl)	FINISH
6220	1L x GX53	Blanco-White
6221	1L x GX53	Blanco-White
6222	1L x GX53	Negro-Black
máx. 12W LED (No incl)		100-240V - 50/60Hz Metal-Metal



Bombillas recomendadas - Suggested bulbs

REFERENCE	Wattios LED	CCT	Lumens	Ángulo luz
 R09224	9W	3000K	730lm	120°
 R09225	9W	4000K	740lm	120°
 R09248	12W	3000K	930lm	120°
 R09249	12W	4000K	960lm	120°



6221



6220

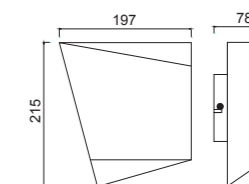
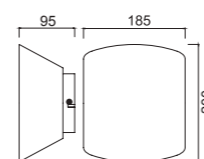

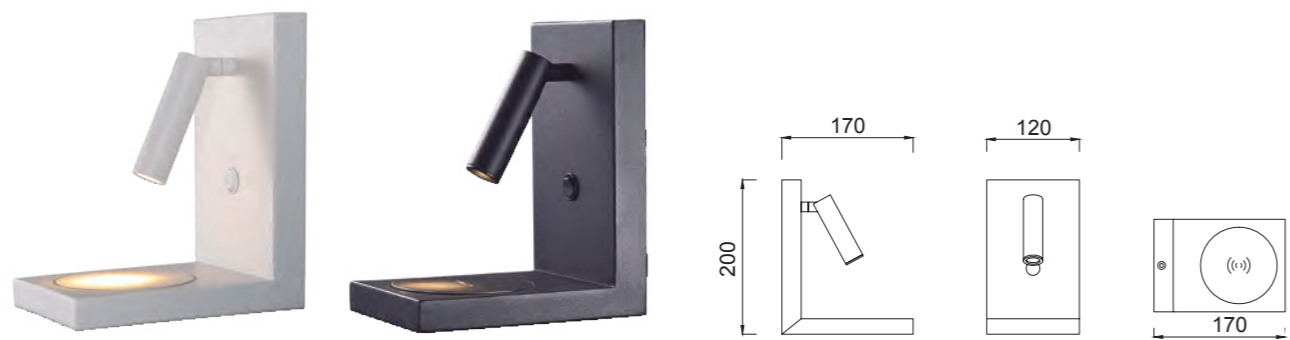

⚡ *Cargador Inalámbrico de inducción-Wireless Induction Charger

REFERENCE	K	LED WATT	LUMENS	FINISH
6750	3000K	3W	210lm	Blanco arena-Sand white
6752	3000K	3W	210lm	Negro arena-Sand black
		100-240V~50/60Hz	CRI≥ 80	Aluminio/Metal-Aluminium/Metal

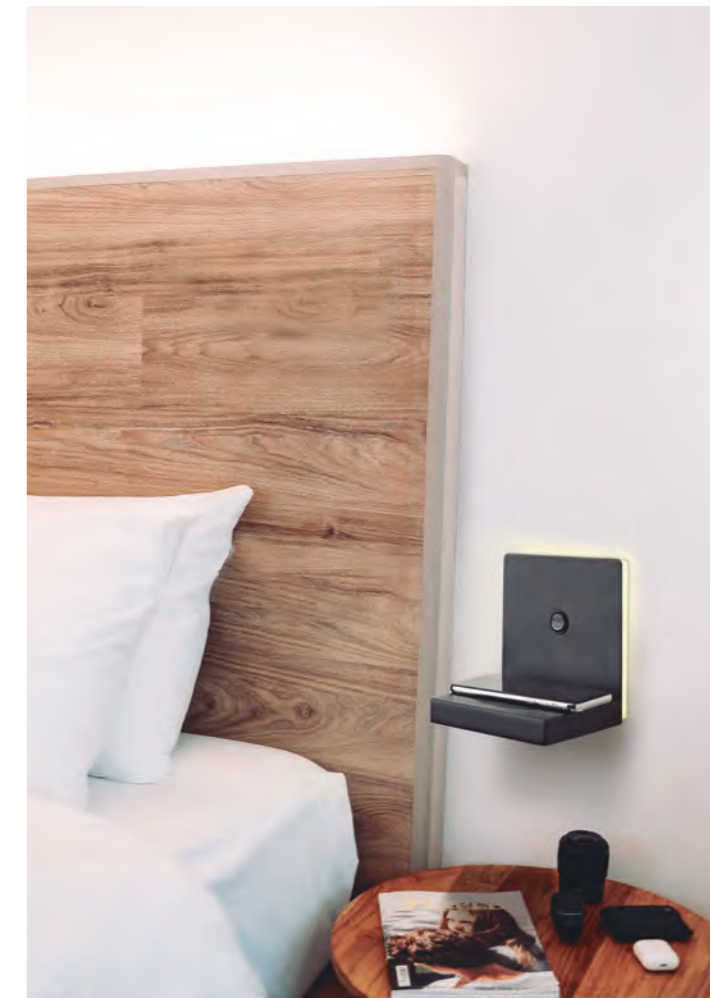

⚡ *Cargador Inalámbrico de inducción-Wireless Induction Charger

REFERENCE	K	LED WATT	LUMENS	FINISH
6754	3000K	3W	210lm	Blanco mate-Matt white
6755	3000K	3W	210lm	Negro mate-Matt black
		100-240V~50/60Hz	CRI≥ 80	Aluminio/Metal-Aluminium/Metal

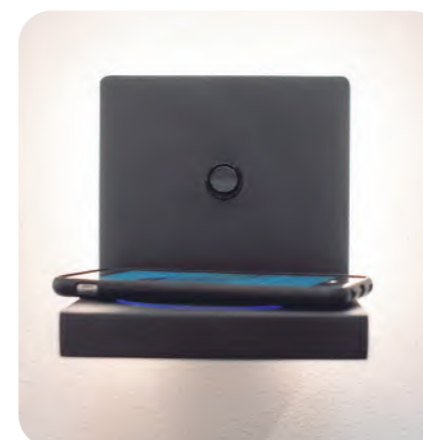
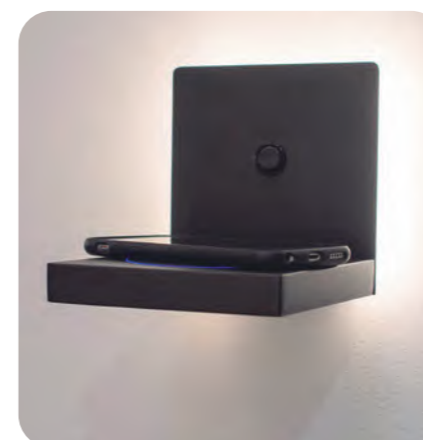
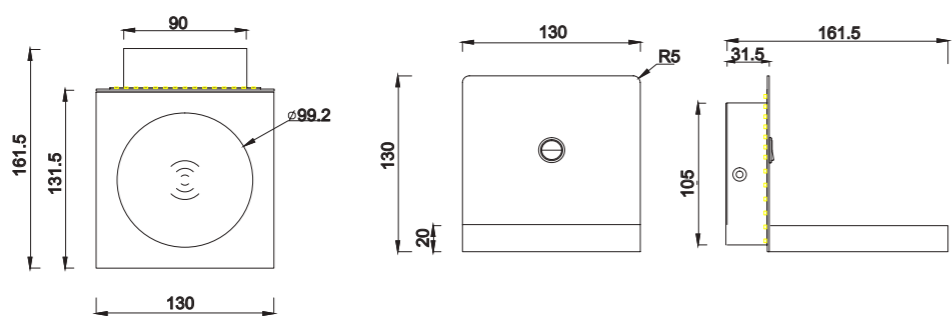

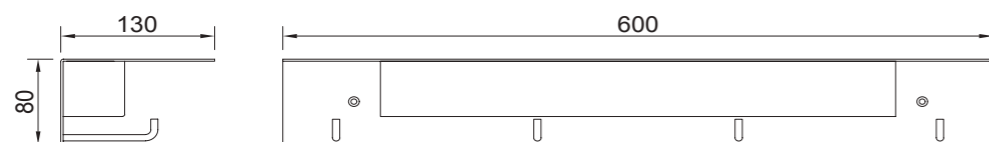

REFERENCE	K	LED WATT	LUMENS	FINISH
6865	3000K	9W	600lm	Blanco mate - Matt white
		100-250V~ 50/60Hz CRI: ≥ 80		Acero/Acrylic - Steel/Acrylic



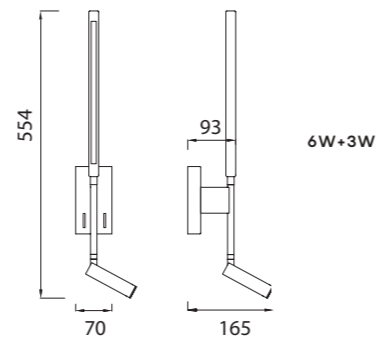
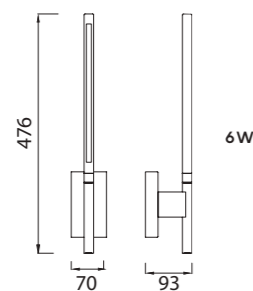

REFERENCE	K	LED WATT	LUMENS	FINISH
6700	3000K	6W	410lm	Blanco mate - Matt white
6701	3000K	6W	410lm	Negro mate - Matt black
6702	3000K	6W+3W	410lm+210lm	Blanco mate - Matt white
6703	3000K	6W+3W	410lm+210lm	Negro mate - Matt black
				Aluminio - Aluminium

220-240V - 50/60Hz CRI ≥ 80

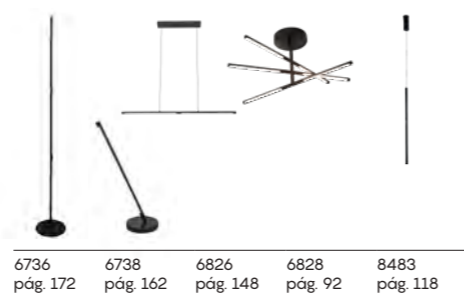
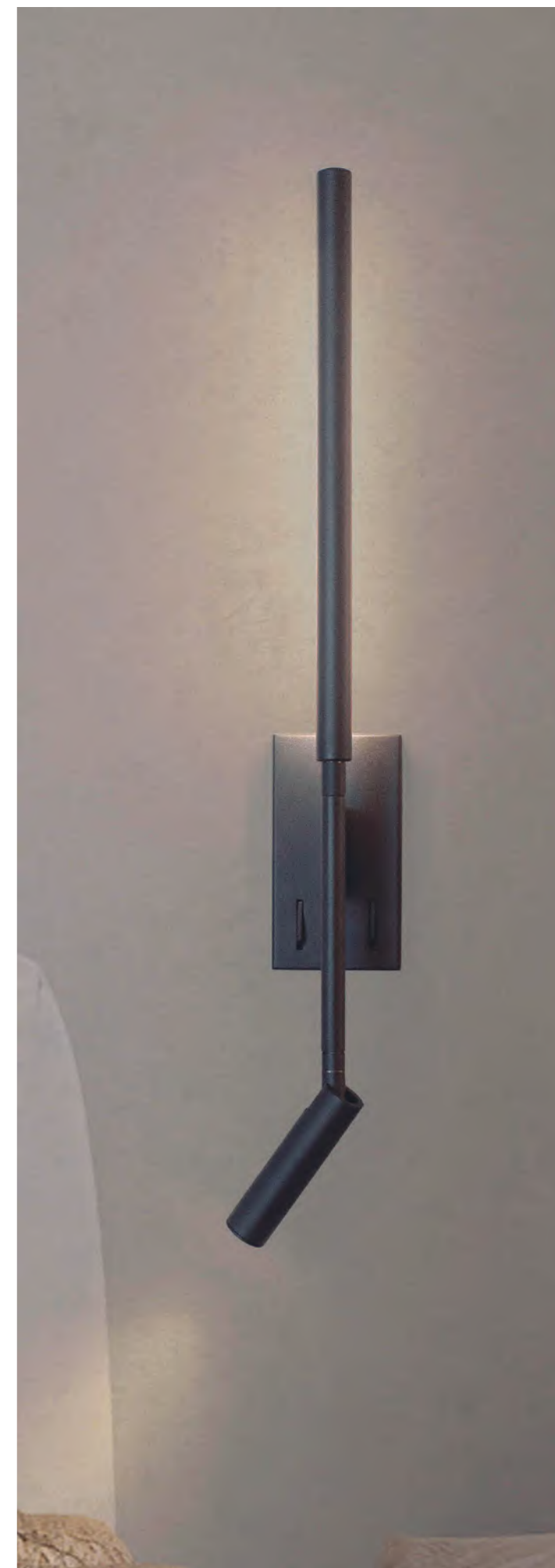

6736 pág. 172 6738 pág. 162 6826 pág. 148 6828 pág. 92 8483 pág. 118





REFERENCE	BULB (No incl)	FINISH	
7523	1L x GU10	Blanco mate-Matt white	Sin interruptor No switch
7518	1L x GU10	Negro mate-Matt black	Sin interruptor No switch
7524	1L x GU10	Blanco mate-Matt white	Con interruptor With switch
7519	1L x GU10	Negro mate-Matt black	Con interruptor With switch
	máx. 10W LED (No incl)	100-240V~50/60Hz Aluminio-Aluminium	



Bombillas recomendadas-Suggested bulbs

K	Wat LED	Reference
3000K	6W	R09196
4000K	6W	R09214
5000K	6W	R09197

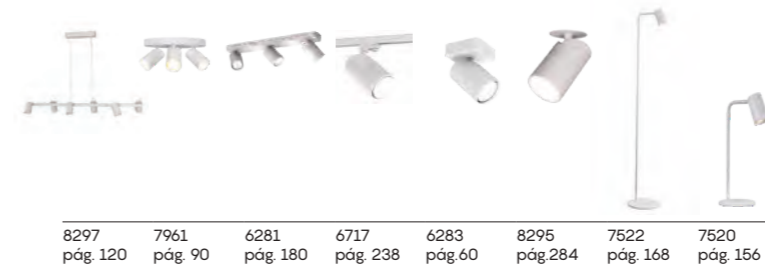

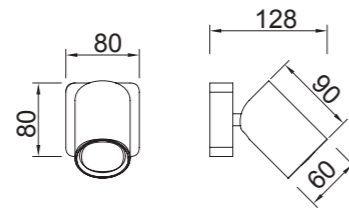
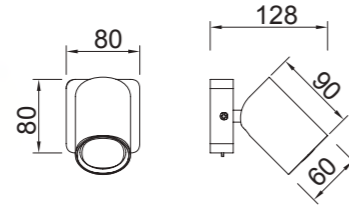

ErP COMPLIANT

RoHS compliant

REFERENCE	BULB (No incl)	FINISH	
6283	1L x GU10	Blanco mate-Matt white	Sin interruptor No switch
6713	1L x GU10	Negro mate-Matt black	Sin interruptor No switch
NEW 8490	1L x GU10	Oro-Gold	Sin interruptor No switch
6284	1L x GU10	Blanco mate-Matt white	Con interruptor With switch
6714	1L x GU10	Negro mate-Matt black	Con interruptor With switch
máx. 10W LED (No incl)		100-240V - 50/60Hz Aluminio-Aluminium	



Bombillas recomendadas-Suggested bulbs

	K	Wat LED	Reference
	3000K	6W	R09196
	4000K	6W	R09214
	5000K	6W	R09197

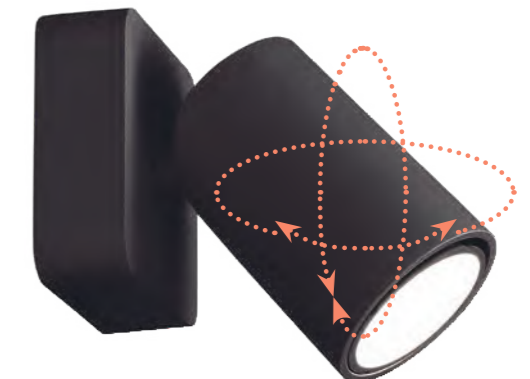

CAYMAN

Aplique lector-Wall lamp reader

Indoor



REFERENCE	K	LED WATT	LUMENS	FINISH
6080	3000K	3+6W	210+410lm	Blanco mate-Matt white
6081	3000K	3+6W	210+410lm	Níquel satinado-Satin nickel
6082	3000K	3+6W	210+410lm	Cuero-Antique brass
6083	3000K	3+6W	210+410lm	Negro mate-Matt black
7853	3000K	3+6W	210+410lm	Oro-Gold
				Aluminio-Aluminium
220-240V~ 50/60Hz CRI: ≥ 80				



REFERENCE	K	LED WATT	LUMENS	FINISH
7823	3000K	3+6W	210+410lm	Blanco mate-Matt white
7824	3000K	3+6W	210+410lm	Níquel satinado-Satin nickel
7825	3000K	3+6W	210+410lm	Cuero-Antique brass
7826	3000K	3+6W	210+410lm	Negro mate-Matt black
7854	3000K	3+6W	210+410lm	Oro-Gold
				Aluminio-Aluminium
220-240V~ 50/60Hz CRI: ≥ 80				



ErP
COMPLIANT



REFERENCE	K	LED WATT	LUMENS	FINISH
6046	3000K	3W	185lm	Blanco-White
6047	3000K	3W	185lm	Negro-Black
		220-240V~50/60Hz CRI:≥ 80		Aluminio/acrílico-Aluminium/acrylic



REFERENCE	K	LED WATT	LUMENS	FINISH
6050	3000K	5W	285lm	Blanco-White
6051	3000K	5W	285lm	Negro-Black
		220-240V~ 50/60Hz CRI:≥ 80		Aluminio-Aluminium





REFERENCE	K	LED WATT	LUMENS	FINISH
6820	3000K	3W	210lm	Blanco arena - Sand white
6821	3000K	3W	210lm	Negro arena - Sand black
				Aluminio - Aluminium

100-240V ~ 50/60Hz CRI: ≥ 80

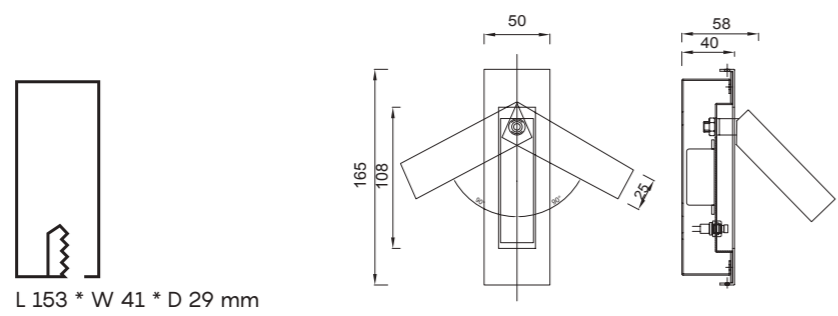

TARIFA II
New

Aplique lector-Wall lamp reader

Indoor

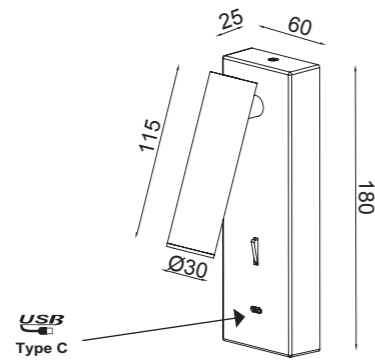

REFERENCE	K	LED WATT	LUMENS	FINISH
8498	3000K	3W	210lm	Blanco mate-Matt white
8499	3000K	3W	210lm	Negro mate-Matt black
8500	3000K	3W	210lm	Níquel satinado-Satin nickel
8501	3000K	3W	210lm	Cuero-Antique brass
220-240V - 50/60Hz CRI: ≥ 80				Aluminio-Aluminium



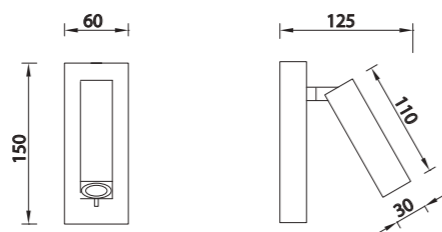

REFERENCE	K	LED WATT	LUMENS	FINISH
6070	3000K	3W	210lm	Blanco mate-Matt white
6071	3000K	3W	210lm	Níquel satinado-Satin nickel
6072	3000K	3W	210lm	Cuero-Antique brass
100-240V~50/60Hz CRI:≥ 80				Aluminio-Aluminium





REFERENCE	K	LED WATT	LUMENS	FINISH
6075	3000K	3W	210lm	Blanco mate-Matt white
6076	3000K	3W	210lm	Níquel satinado-Satin nickel
6077	3000K	3W	210lm	Cuero-Antique brass
				Aluminio-Aluminium

100-240V~50/60Hz CRI:≥ 80

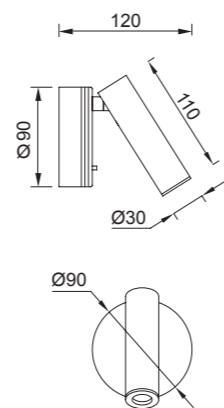



REFERENCE	BULB (No incl)	FINISH	LECTOR/READER	LUMENS
6091	1L x E27	Blanco mate-Matt white	3W	210lm
6092	1L x E27	Níquel Satinado-Satin Nickel	3W	210lm
6093	1L x E27	Cuero-Antique brass	3W	210lm
máx. 20W LED (No incl)		220-240V-50/60Hz CRI:≥ 80 Aluminio-Aluminium	Cargador USB /Charger USB Pantalla blanca/White shade	

USB
Output

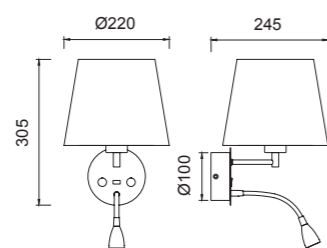

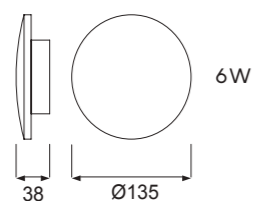

6W

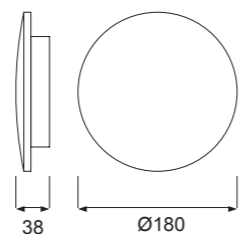

12W

REFERENCE	K	LED WATT	LUMENS	FINISH
C0127	2700K	6W	420lm	Blanco-White
C0131	2700K	6W	420lm	Negro-Black
C0101	3000K	6W	540lm	Blanco-White
C0119	3000K	6W	540lm	Negro-Black
C0128	2700K	12W	840lm	Blanco-White
C0132	2700K	12W	840lm	Negro-Black
C0102	3000K	12W	1080lm	Blanco-White
C0120	3000K	12W	1080lm	Negro-Black
220-240V ~50/60Hz CRI: ≥ 80				Aluminio-Aluminium

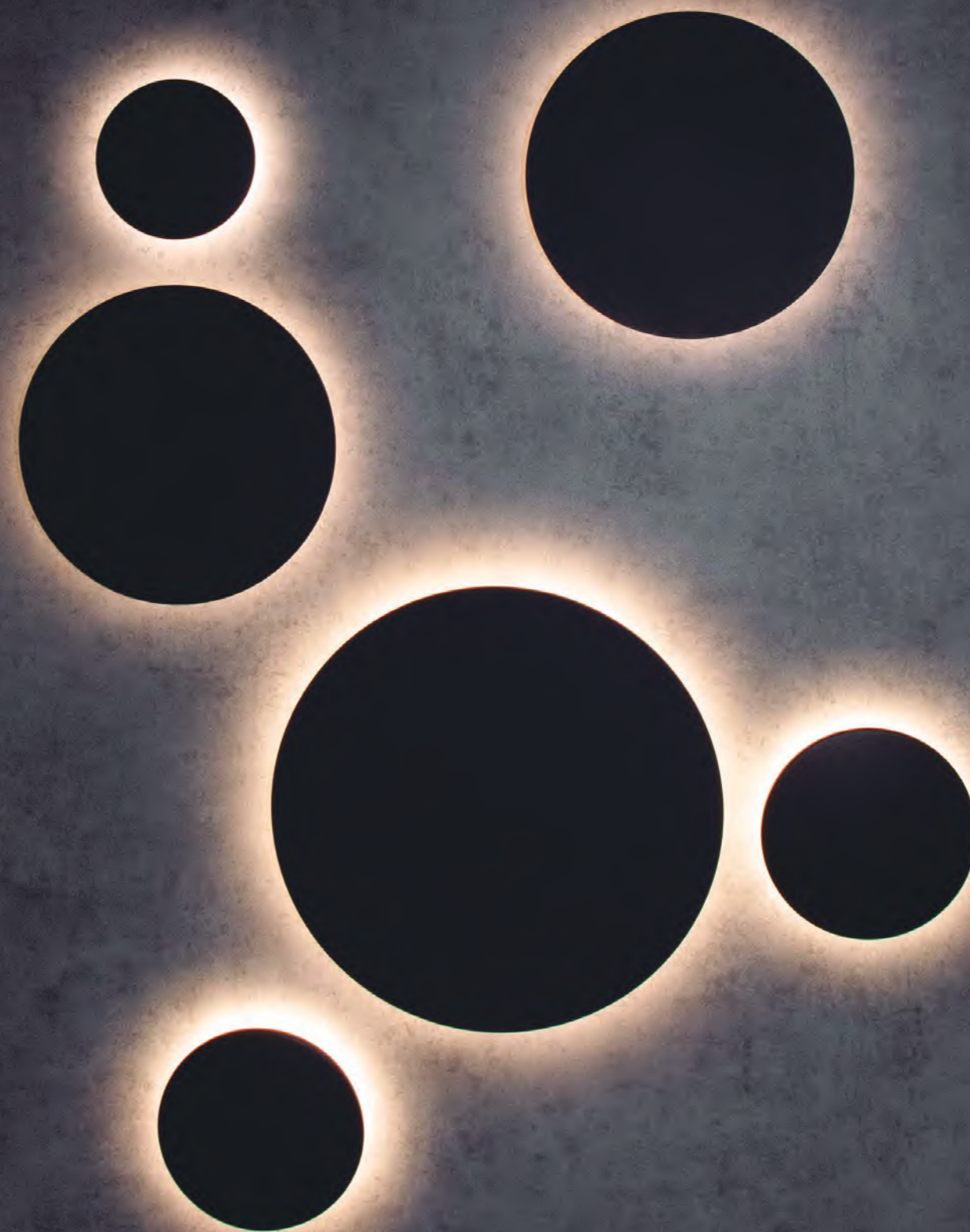

BORA BORA

Apliques - Wall lights

Indoor

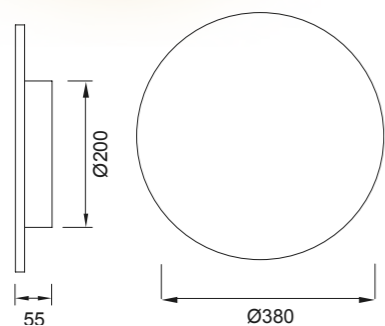
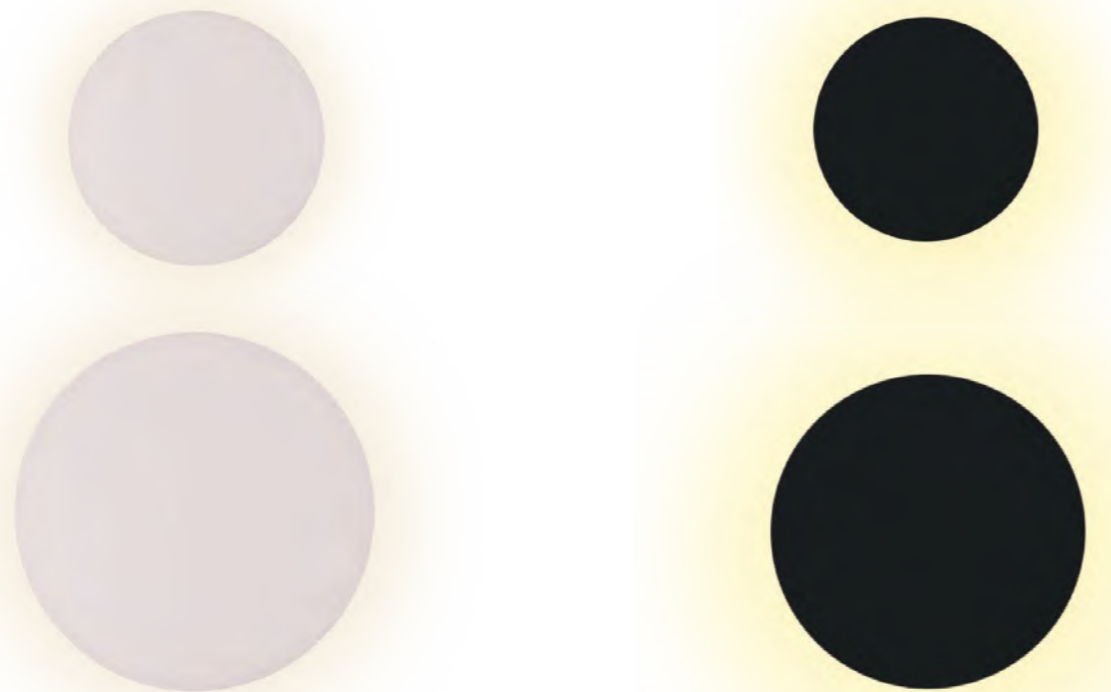

30W

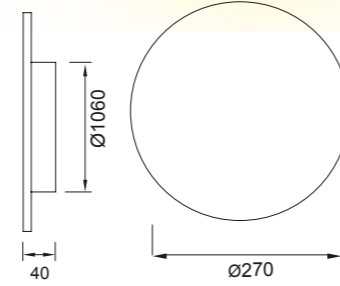

16W



REFERENCE	K	LED WATT	LUMENS	FINISH
C0129	2700K	16W	1120lm	Blanco-White
C0133	2700K	16W	1120lm	Negro-Black
C0117	3000K	16W	1350lm	Blanco-White
C0124	3000K	16W	1350lm	Negro-Black
C0130	2700K	30W	2100lm	Blanco-White
C0134	2700K	30W	2100lm	Negro-Black
C0125	3000K	30W	2400lm	Blanco-White
C0126	3000K	30W	2400lm	Negro-Black
220-240V ~50/60Hz CRI: ≥ 80				Aluminio-Aluminium





C0103

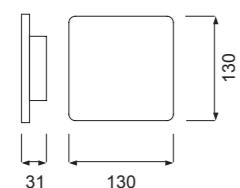

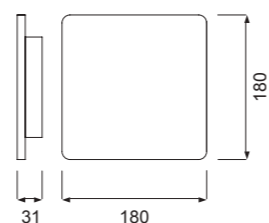

C0104



REFERENCE	K	LED WATT	LUMENS	FINISH	SIZES
C0103	3000K	6W	540lm	Blanco-White	130 x 130
C0104	3000K	12W	1080lm	Blanco-White	180 x 180
220-240V - 50/60Hz CRI: ≥ 80				Aluminio-Aluminium	

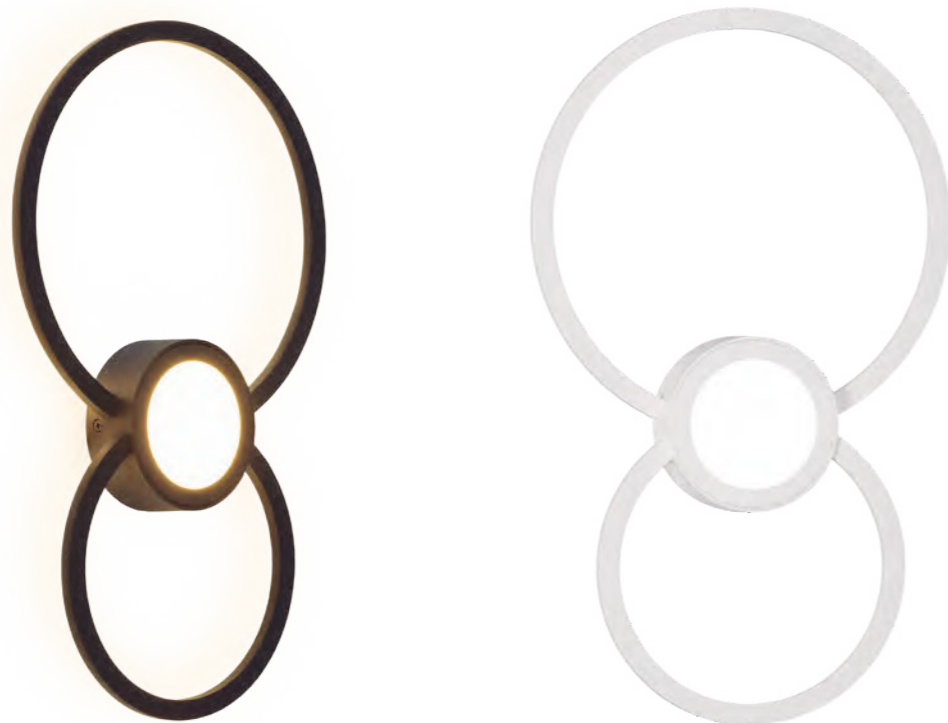



REFERENCE	K	LED WATT	LUMENS	FINISH	INPUT	
6230	3000K	24W	1440lm	Blanco mate-Matt white	100-250V~ 50/60Hz	On-off
7460	3000K	24W	1440lm	Negro mate-Matt black	100-250V~ 50/60Hz	On-off
7840	3000K	24W	1440lm	Blanco mate-Matt white	220-240V~50/60Hz	Dimmable 
7841	3000K	24W	1440lm	Negro mate-Matt black	220-240V~50/60Hz	Dimmable 
					CRI: ≥ 80	Aluminio-Aluminium

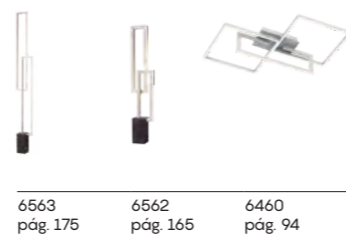
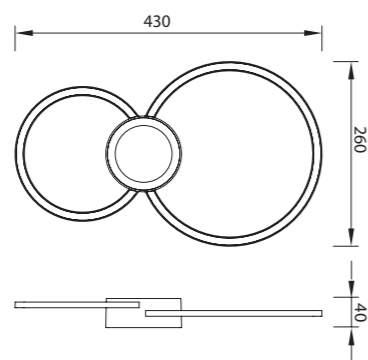



REFERENCE	K	LED WATT	LUMENS	FINISH
6382	3000K	8W	619lm	Cuero-Antique brass
6380	3000K	8W	619lm	Cromo-Chrome
6383	3000K	12W	908lm	Cuero-Antique brass
6381	3000K	12W	908lm	Cromo-Chrome
6385	3000K	18W	1257lm	Cuero-Antique brass
6384	3000K	18W	1257lm	Cromo-Chrome
175-265V~50/60Hz CRI:≥ 80				Aluminio-Aluminium

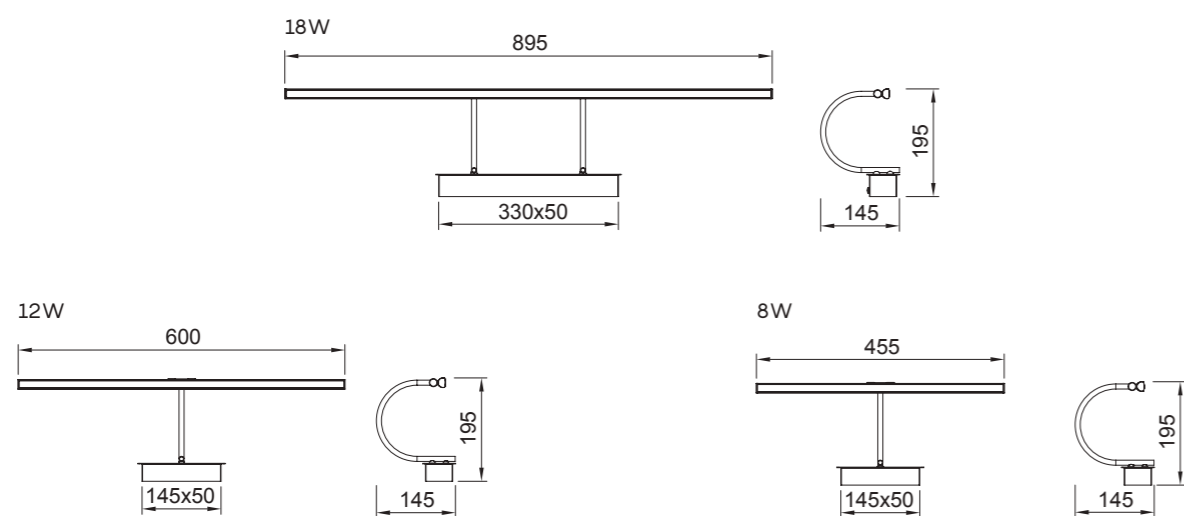

Plafones

Ceiling lights

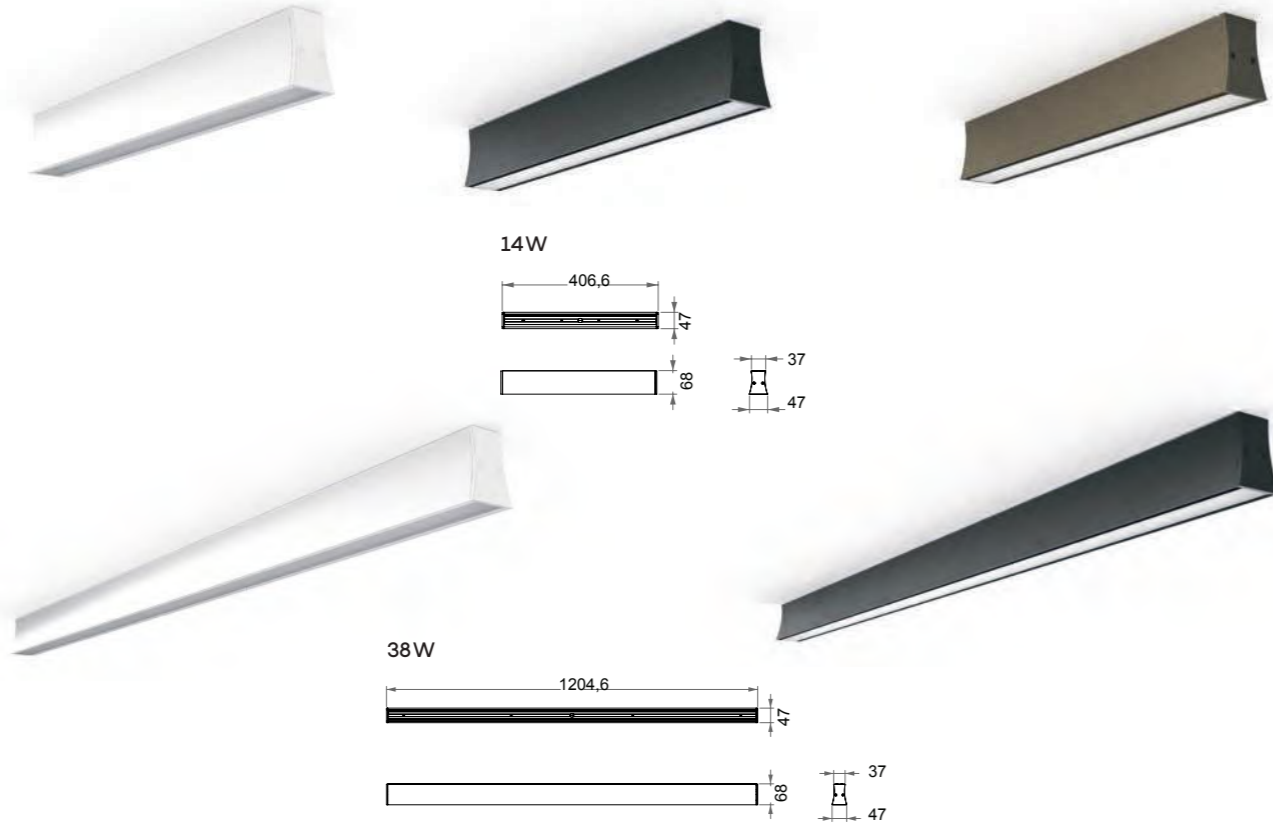

REFERENCE	K	LED WATT	LUMENS	FINISH
7949	3000K	14W	950lm	Blanco-White
7951	3000K	14W	950lm	Negro-Black
7953	3000K	14W	950lm	Arena-Sabbia
7950	4000K	14W	1000lm	Blanco-White
7952	4000K	14W	1000lm	Negro-Black
7945	3000K	38W	2850lm	Blanco-White
7947	3000K	38W	2850lm	Negro-Black
7946	4000K	38W	3000lm	Blanco-White
7948	4000K	38W	3000lm	Negro-Black

220-240V-50/60Hz CRI≥ 80 Aluminio-Aluminium

7548 pág. 130 7953 pág. 30 7546 pág. 126

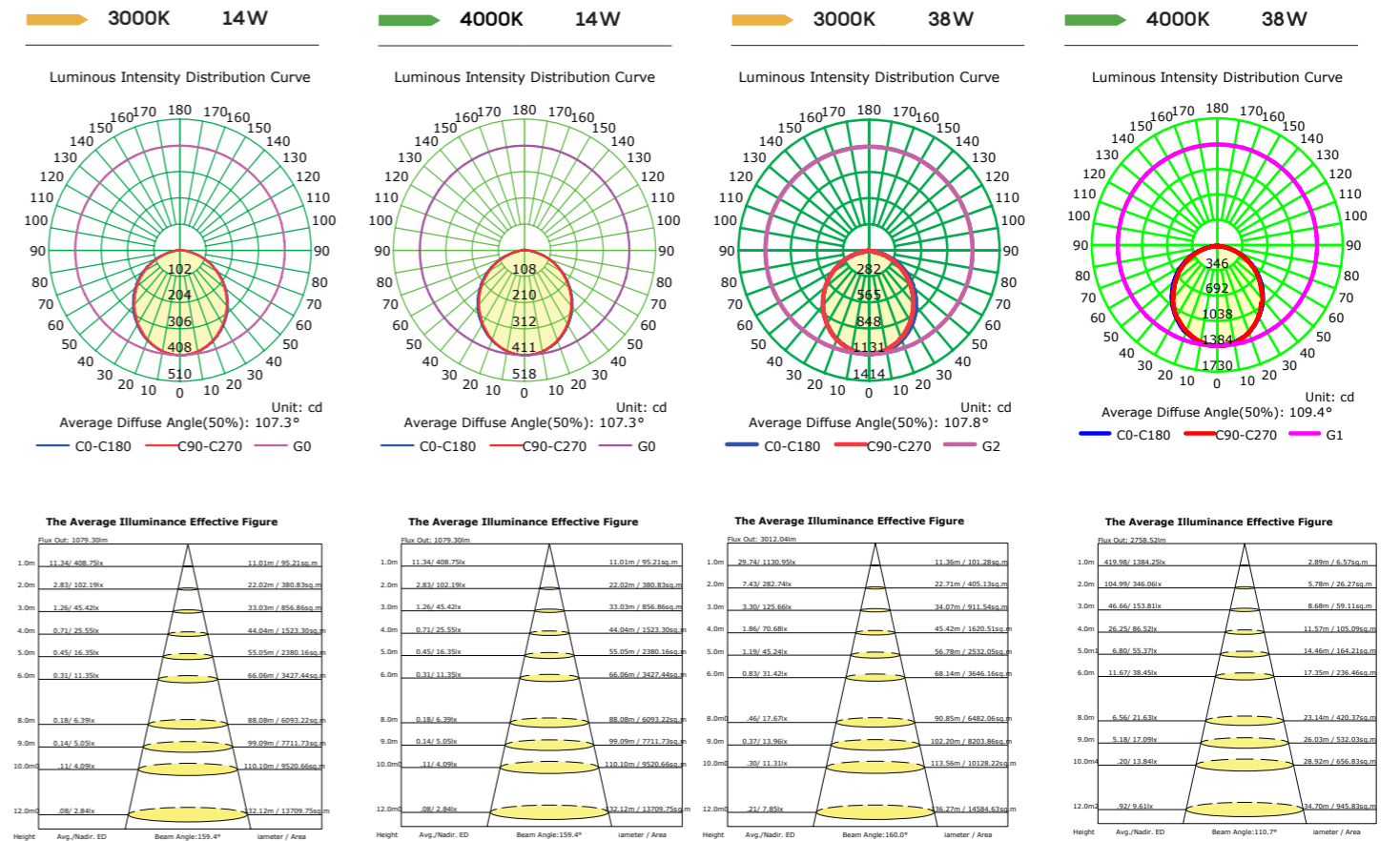



REFERENCE	BULB (No incl)	FINISH
7961	3L x GU10	Blanco mate-Matt white
7962	3L x GU10	Negro mate-Matt black
máx. 10W LED (No incl) 100-240V-50/60Hz Aluminio-Aluminium		

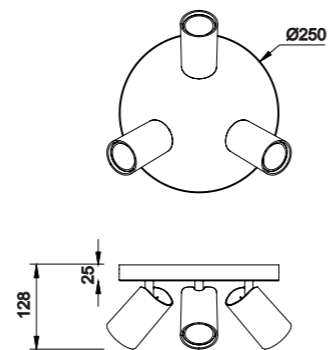

Bombillas recomendadas-Suggested bulbs

K	Wat LED	Reference
3000K	6W	R09196
4000K	6W	R09214
5000K	6W	R09197



8297 pág. 120	6281 pág. 180	6717 pág. 238	6283 pág. 60	7523 pág. 58	8295 pág. 284
------------------	------------------	------------------	-----------------	-----------------	------------------



7522 pág. 158 7520 pág. 156





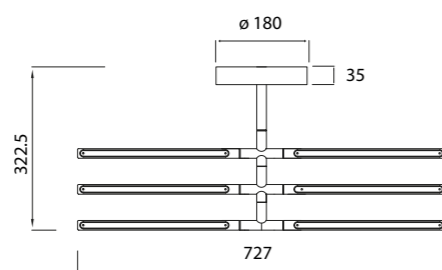

REFERENCE	K	LED WATT	LUMENS	FINISH
6827	3000K	36 W	2850lm	Blanco arena-Sand white
6828	3000K	36 W	2850lm	Negro arena-Sand black
				Aluminio-Aluminium
220-240V~50/60Hz CRI:≥ 80				



6736 pág. 172 6738 pág. 162 6826 pág. 148 8483 pág. 118 6703 pág. 56

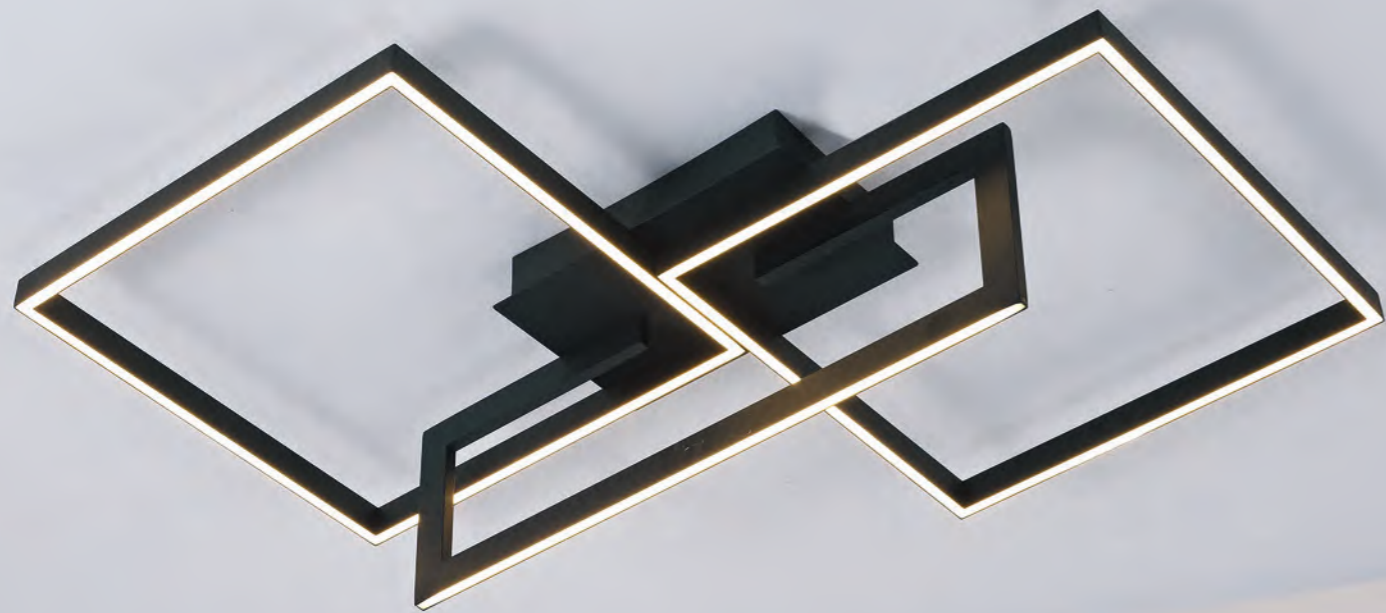



REFERENCE	K	LED WATT	LUMENS	FINISH	
6560	3000K	48W	3840lm	Blanco mate-Matt white	On-off
6561	3000K	48W	3840lm	Blanco mate-Matt white	Dimmable 
7462	3000K	48W	3840lm	Negro-Black	On-off
7463	3000K	48W	3840lm	Negro-Black	Dimmable 
220-240V ~50/60Hz CRI:≥ 80				Aluminio-Aluminium	

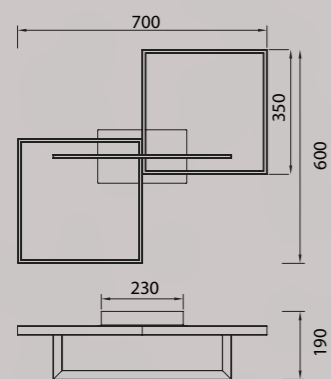

6230 pág. 82 6563 pág. 175 6562 pág. 165





REFERENCE	BULB NO INCLUDED	FINISH
5410	5L x E27	Blanco-White
5411	3L x E27	Blanco-White
máx. 20W LED (No incl)		100-240V - 50/60Hz Metal-Metal/Acrylic

5L

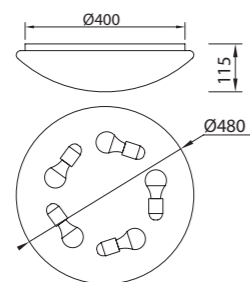

3L

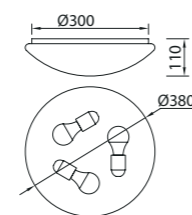



Downlight en superficie para paredes y soluciones sin falso techo.

REFERENCE	K	LED WATT	LUMENS	FINISH
6620	3000K	8W	680lm	Blanco mate-Matt white
6621	4000K	8W	720lm	Blanco mate-Matt white
6622	3000K	14W	1190lm	Blanco mate-Matt white
6623	4000K	14W	1260lm	Blanco mate-Matt white
6624	3000K	24W	2040lm	Blanco mate-Matt white
6625	4000K	24W	2160lm	Blanco mate-Matt white
6626	3000K	30W	2550lm	Blanco mate-Matt white
6627	4000K	30W	2700lm	Blanco mate-Matt white
220-240V ~50/60Hz CRI≥ 80				Aluminio-Aluminium

Downlight en superficie para paredes y soluciones sin falso techo.

REFERENCE	K	LED WATT	LUMENS	FINISH
6628	3000K	8W	680lm	Blanco mate-Matt white
6629	4000K	8W	720lm	Blanco mate-Matt white
6630	3000K	14W	1190lm	Blanco mate-Matt white
6631	4000K	14W	1260lm	Blanco mate-Matt white
6632	3000K	24W	2040lm	Blanco mate-Matt white
6633	4000K	24W	2160lm	Blanco mate-Matt white
6634	3000K	30W	2550lm	Blanco mate-Matt white
6635	4000K	30W	2700lm	Blanco mate-Matt white
220-240V ~50/60Hz CRI≥ 80				Aluminio-Aluminium

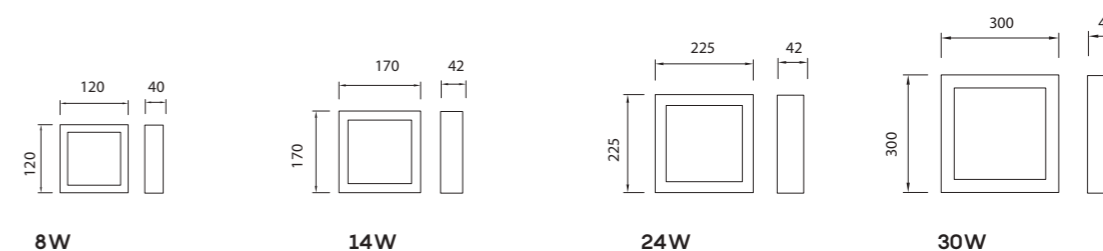
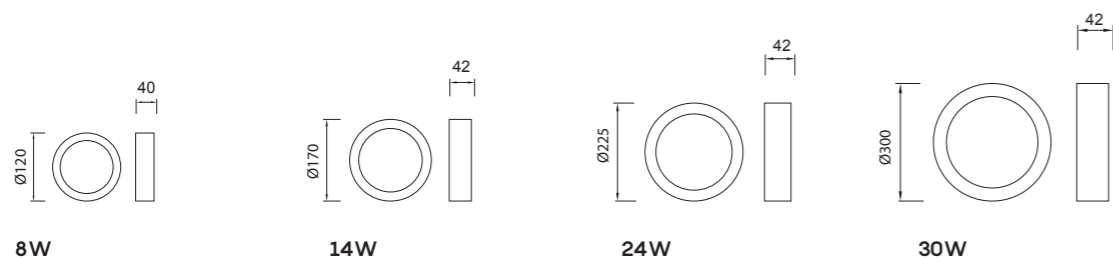

Colgante

Pendant lamp

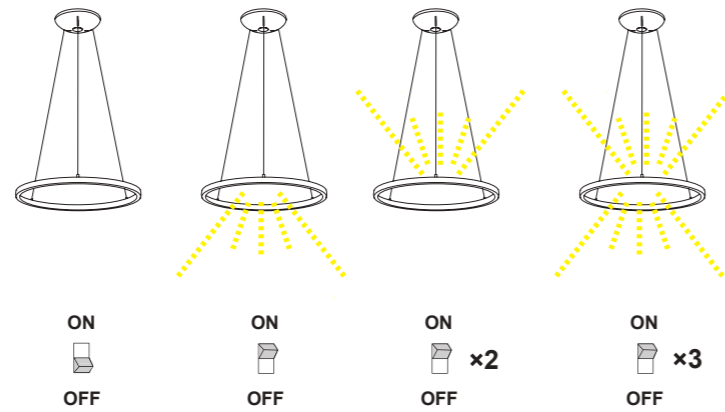
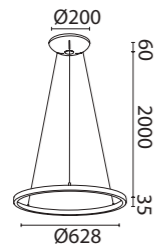

REFERENCE	K	LED WATT	LUMENS	FINISH
8672	3000K	40W+15W	3800lm	Blanco-White
8673	3000K	40W+15W	3800lm	Negro-Black
8674	3000K	40W+15W	3800lm	Arena-Sabbia
	UGR<16	220-240V - 50/60Hz	CRI:≥ 90	Aluminio-Aluminium

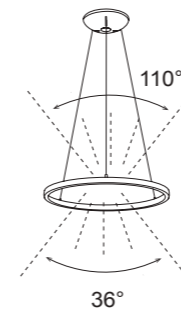

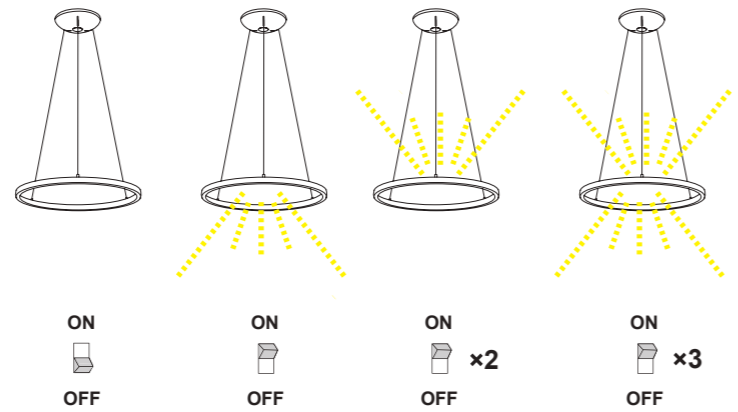
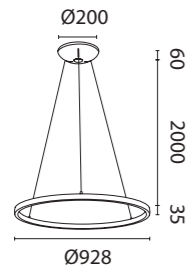

REFERENCE	K	LED WATT	LUMENS	FINISH
8675	3000K	60W+20W	5800lm	Blanco-White
8676	3000K	60W+20W	5800lm	Negro-Black
8677	3000K	60W+20W	5800lm	Arena-Sabbia
	UGR<16	220-240V - 50/60Hz	CRI:≥ 90	Aluminio-Aluminium

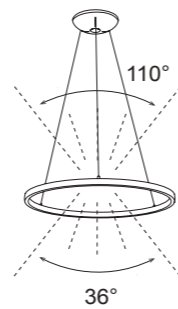

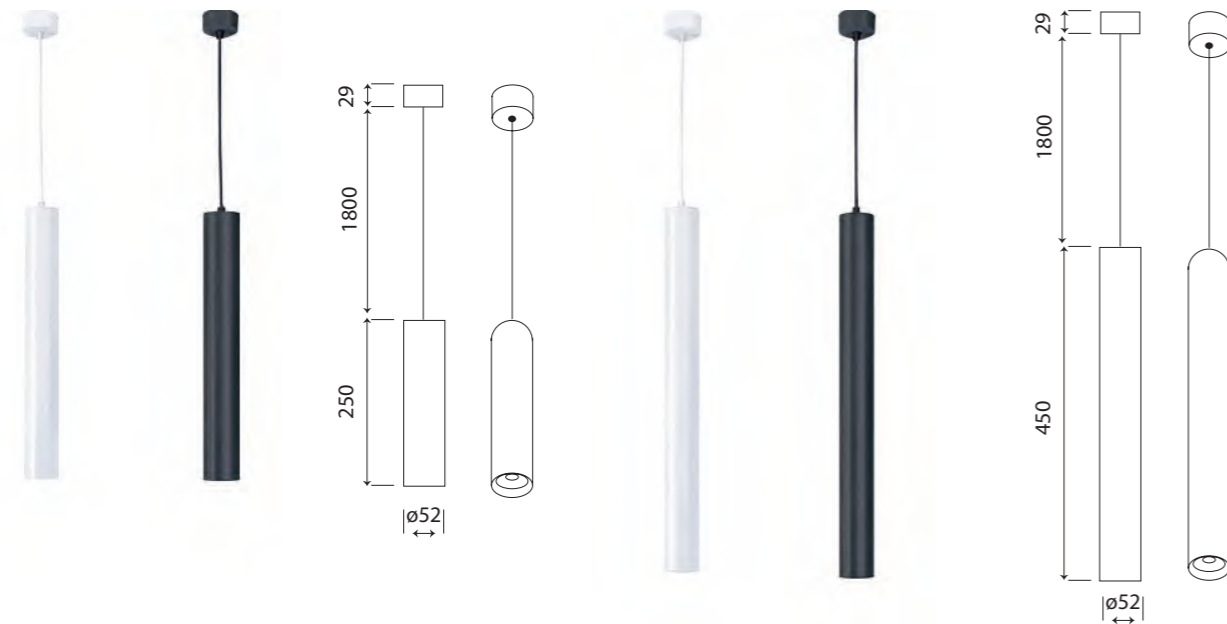

CCT SWITCH
2700K - 3200K - 4000K

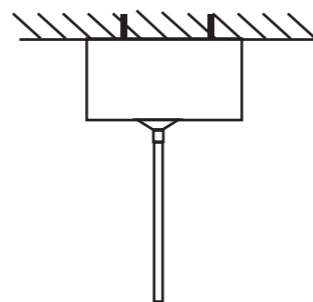

REFERENCE	CCT switch	LED WATT	LUMENS	FINISH
8355	2700K-3200K-4000K	7W	560lm	Blanco-White
8356	2700K-3200K-4000K	7W	560lm	Negro-Black
8357	2700K-3200K-4000K	10W	770lm	Blanco-White
8358	2700K-3200K-4000K	10W	770lm	Negro-Black
UGR<19		220-240V - 50/60Hz CRI:≥ 80		Aluminio-Aluminium



UGR<19



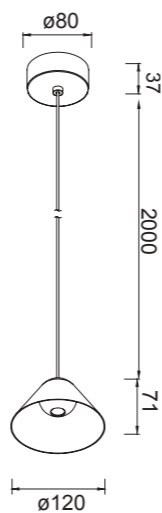
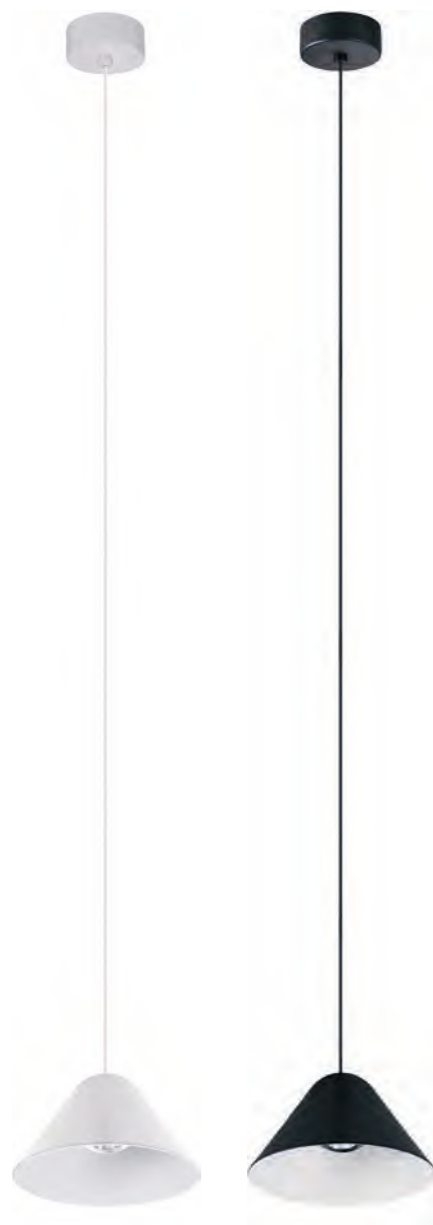

REFERENCE	K	LED WATT	LUMENS	FINISH
8465	3000K	5W	400lm	Blanco-White
8466	3000K	5W	400lm	Negro-Black
220-240V ~ 50/60Hz CRI: ≥ 80				Aluminio-Aluminium



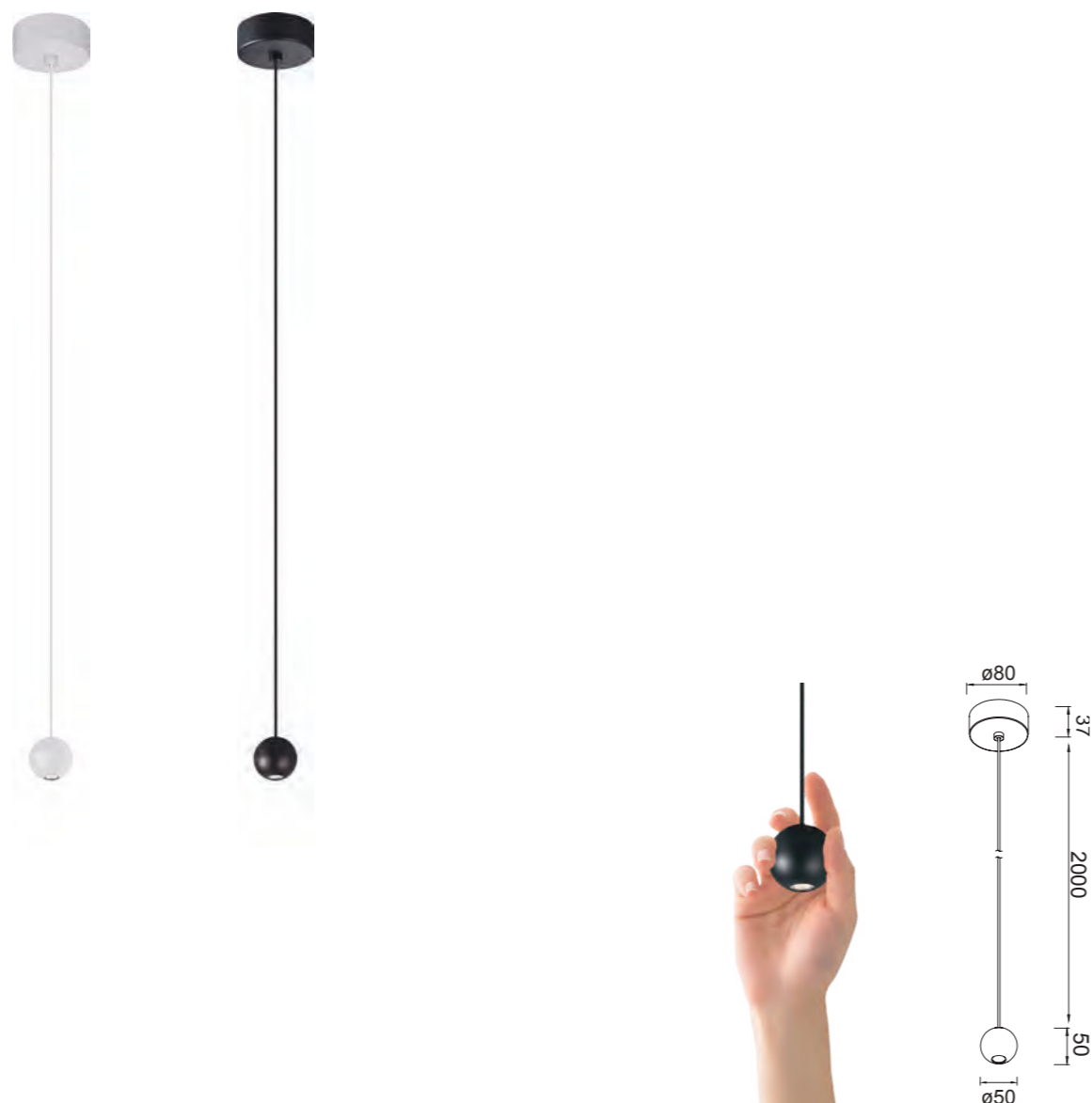

REFERENCE	K	LED WATT	LUMENS	FINISH
8468	3000K	5W	400lm	Blanco-White
8469	3000K	5W	400lm	Negro-Black
220-240V ~ 50/60Hz CRI: ≥ 80				Aluminio-Aluminium



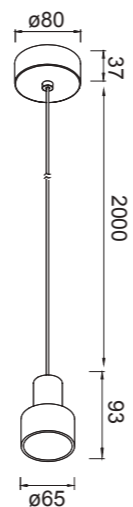

REFERENCE	K	LED WATT	LUMENS	FINISH
8467	3000K	5W	400lm	Negro/Oro-Gold/Black
		220-240V - 50/60Hz	CRI: ≥ 80	Aluminio-Aluminium

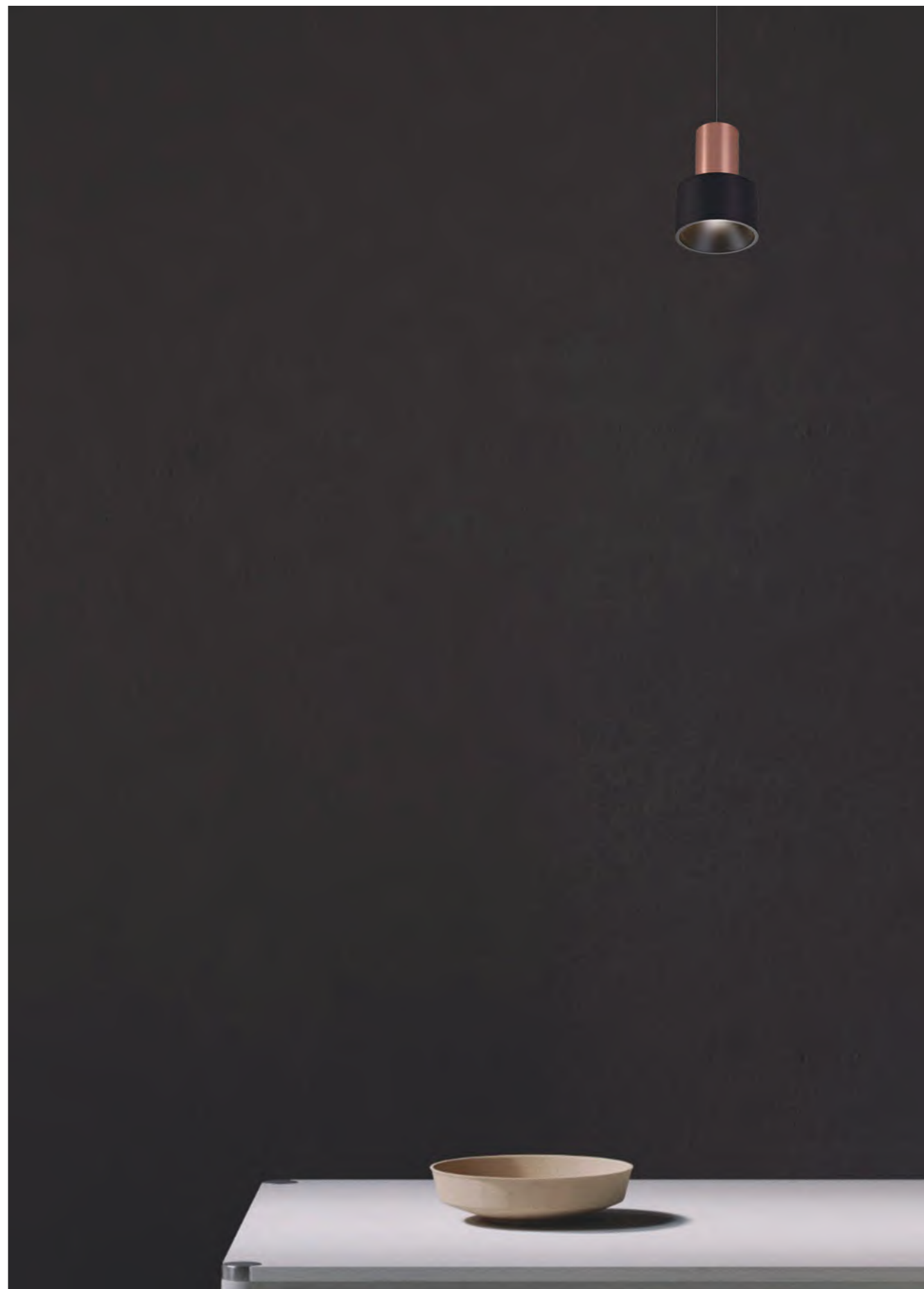

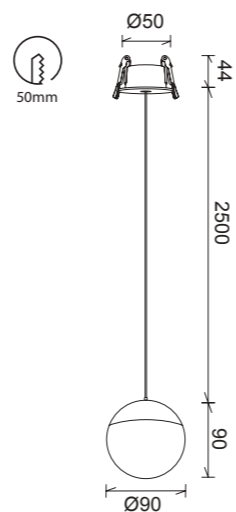

REFERENCE	K	LED WATT	LUMENS	FINISH
8435	3000K	10W	800lm	Blanco-White
8436	3000K	10W	800lm	Negro-Black
8437	3000K	10W	800lm	Oro-Gold
220-240V ~ 50/60Hz CRI: ≥ 80				Aluminio-Aluminium



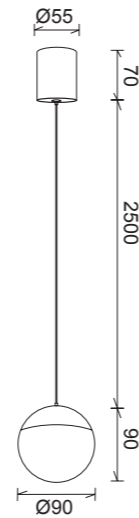

REFERENCE	K	LED WATT	LUMENS	FINISH
8438	3000K	10W	800lm	Blanco-White
8439	3000K	10W	800lm	Negro-Black
8440	3000K	10W	800lm	Oro-Gold
220-240V - 50/60Hz CRI:≥ 80				Aluminio-Aluminium

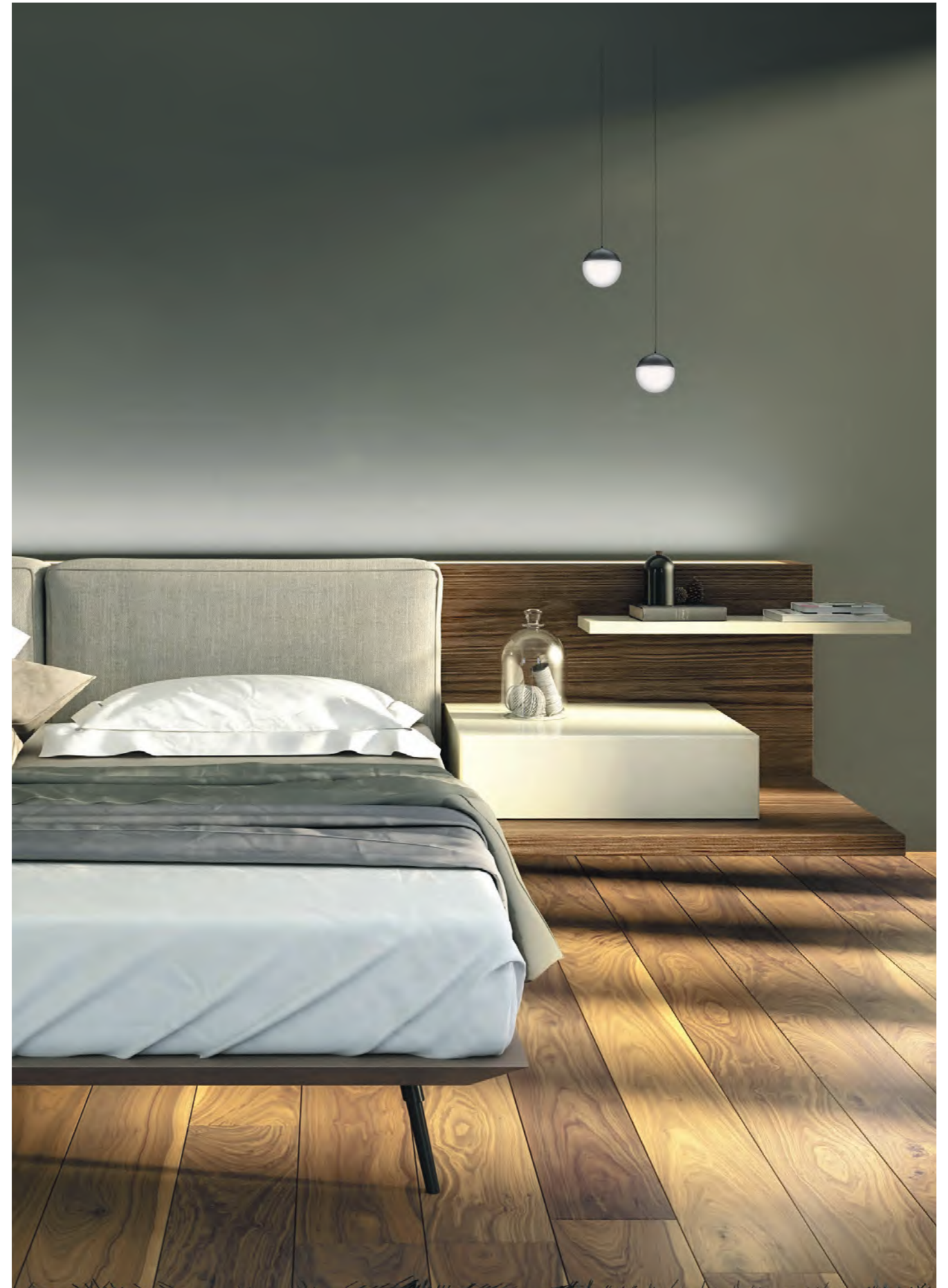

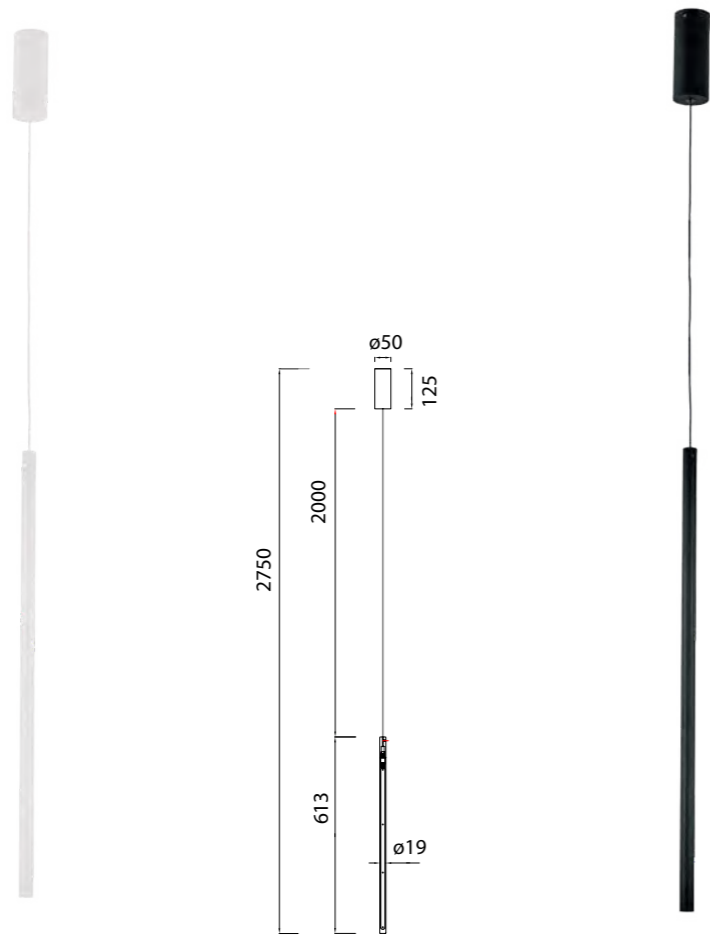

REFERENCE	K	LED WATT	LUMENS	FINISH
8482	3000K	11W	900lm	Blanco mate-Matt white
8483	3000K	11W	900lm	Negro mate-Matt black
220-240V-50/60Hz CRI≥ 80				Aluminio-Aluminium

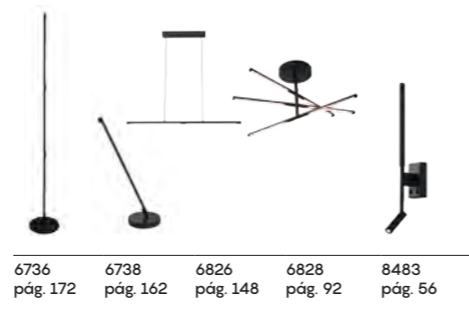

6736 pág. 172 6738 pág. 162 6826 pág. 148 6828 pág. 92 8483 pág. 56



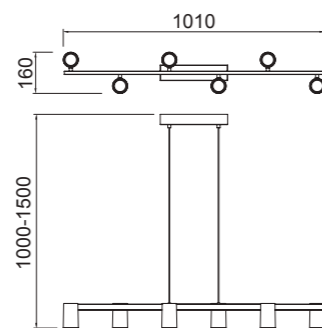

REFERENCE	BULB (No incl)	FINISH
8297	6L x GU10	Blanco mate-Matt white
8298	6L x GU10	Negro mate-Matt black
8486	6L x GU10	Oro+Negro-Gold+Black
	máx. 10W LED (No incl)	100-240V - 50/60Hz Aluminio-Aluminium



Bombillas recomendadas-Suggested bulbs

K	Wat LED	Reference
3000K	6W	R09196
4000K	6W	R09214
5000K	6W	R09197



7961 pág. 90 6281 pág. 180 6717 pág. 238 6283 pág. 60 7523 pág. 58 8295 pág. 284 7522 pág. 158 7520 pág. 156



CLIFTON
New

Colgante-Pendant lamp

Indoor

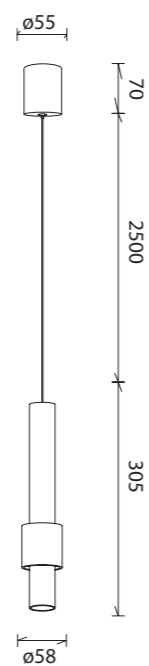

REFERENCE	K	LED WATT	LUMENS	FINISH
8564	3000K	7W	560lm	Blanco-White
8565	3000K	7W	560lm	Negro+Oro-Gold+Black
220-240V - 50/60Hz CRI:≥ 80				Aluminio-Aluminium

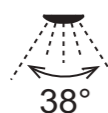

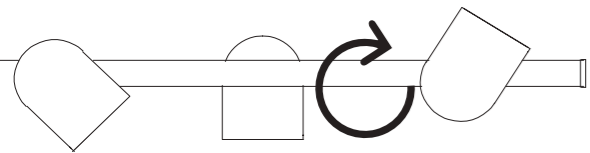
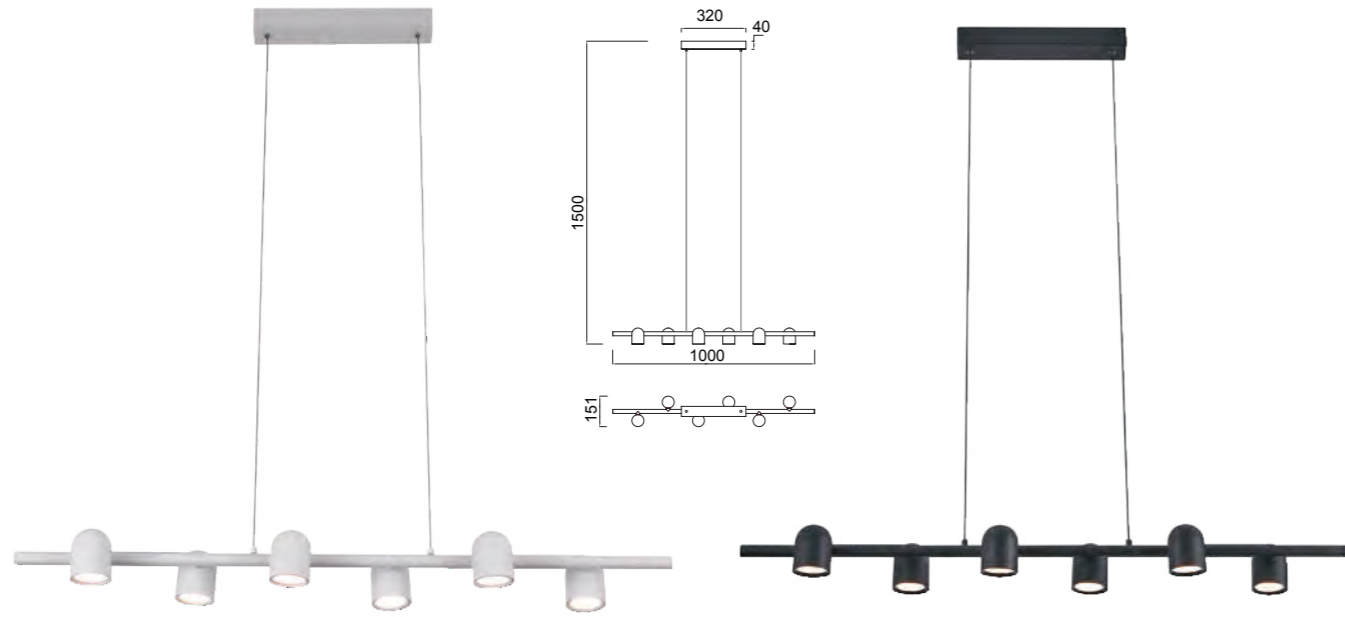

REFERENCE	BULB (No incl)	FINISH
7936	6L x GU10	Blanco-White
7937	6L x GU10	Negro-Black
máx. 12W LED (No incl)		100-240V~50/60Hz Aluminio-Aluminium



7595
pág.184

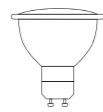

Bombillas recomendadas-Suggested bulbs

K	Wat LED	On/Off	Dimmable	Lumens
2700K	7W	R09254	R09257	510lm
3000K	7W	R09255	R09258	540lm
4000K	7W	R09256	R09259	570lm





REFERENCE	K	LED WATT	LUMENS	FINISH
7542	3000K	38W	2850lm	Blanco-White
7546	3000K	38W	2850lm	Negro-Black
7569	3000K	38W	2850lm	Arena-Sabbia
7543	4000K	38W	3000lm	Blanco-White
7547	4000K	38W	3000lm	Negro-Black
On-off		220-240V~ 50/60Hz CRI≥ 80		Aluminio-Aluminium

7548 pág.130 7951 pág. 88 7953 pág. 30

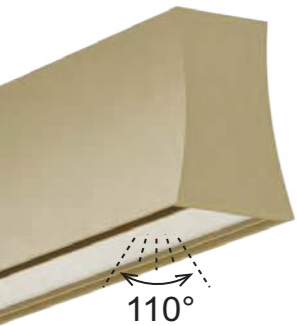
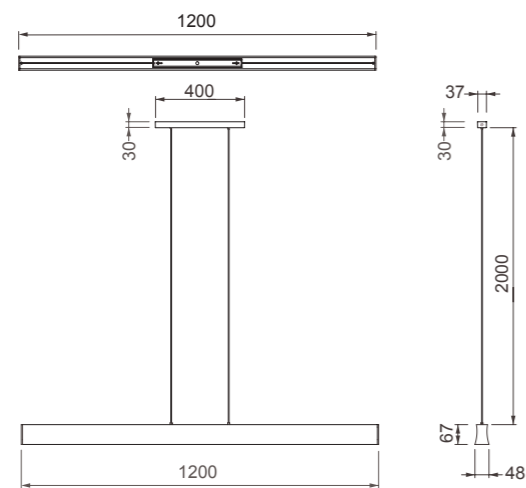

3000K 100° 38W

4000K 100° 38W

Luminous Intensity Distribution Curve

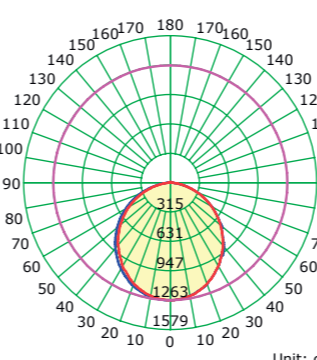

Average Diffuse Angle(50%): 109.0°
— C0-C180 — C90-C270 — G1

Luminous Intensity Distribution Curve

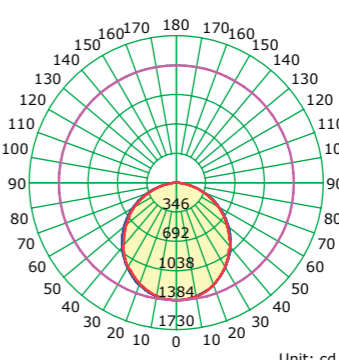

Average Diffuse Angle(50%): 109.4°
— C0-C180 — C90-C270 — G1



REFERENCE	K	LED WATT	LUMENS	FINISH
7540	3000K	38W	2650lm	Blanco-White
7544	3000K	38W	2650lm	Negro-Black
7541	4000K	38W	2800lm	Blanco-White
7545	4000K	38W	2800lm	Negro-Black
UGR<16		220-240V ~ 50/60Hz CRI≥ 90		Aluminio-Aluminium

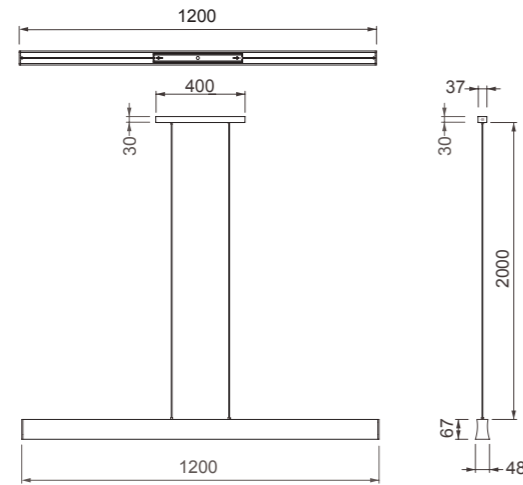
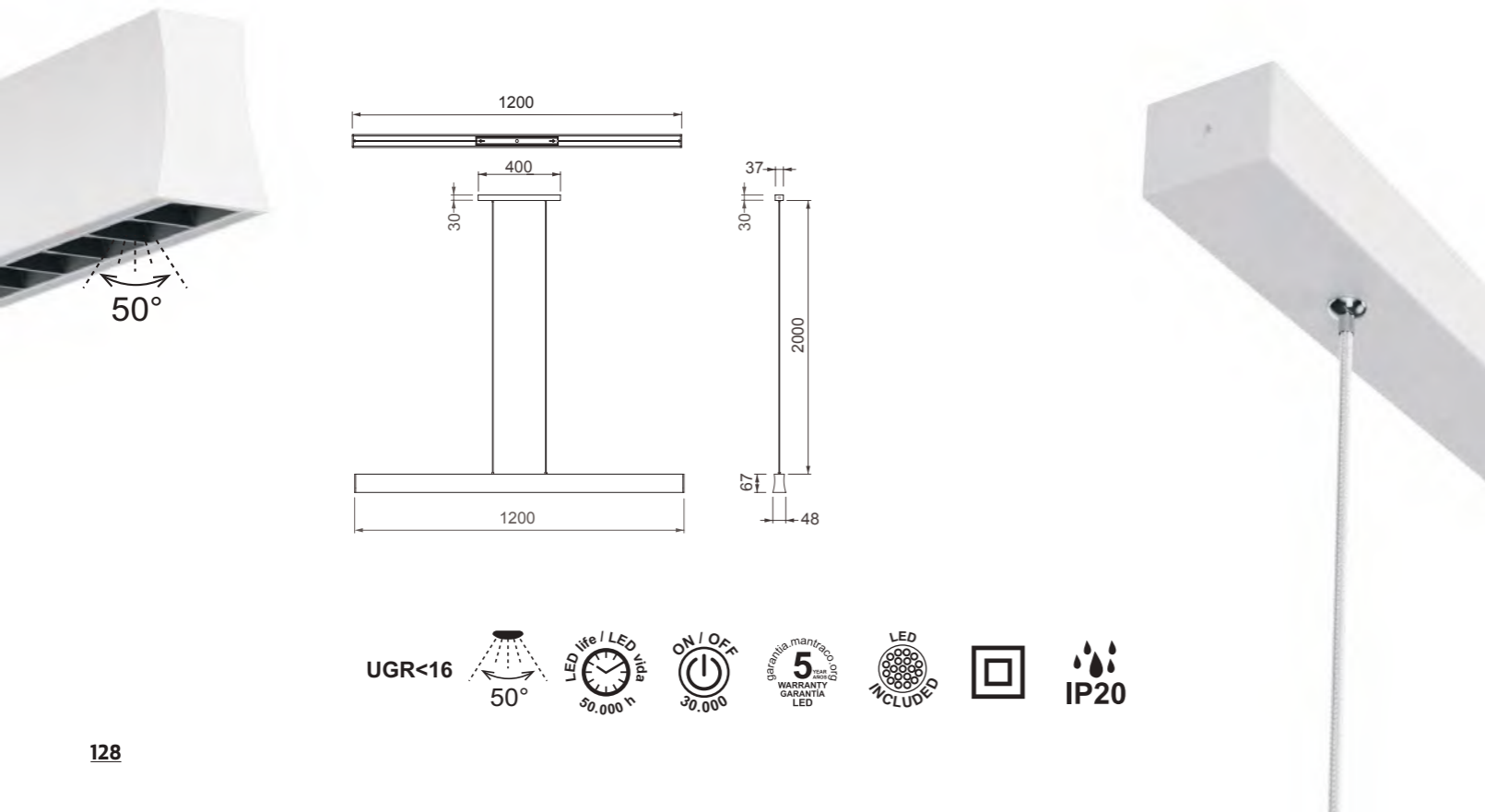

- UGR<16
- LED life / LED vida 50.000 h
- ON / OFF 30.000
- garantía manutención 5 años WARRANTY GARANTIA LED
- LED INCLUDED
- IP20



3000K 50° 38W

4000K 50° 38W

Luminous Intensity Distribution Curve

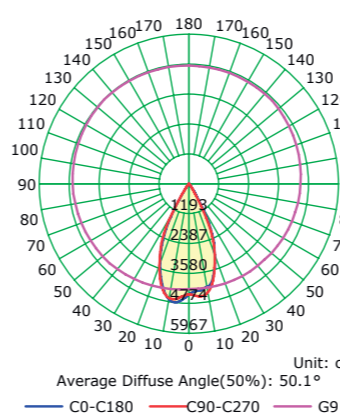

The Average Illuminance Effective Figure

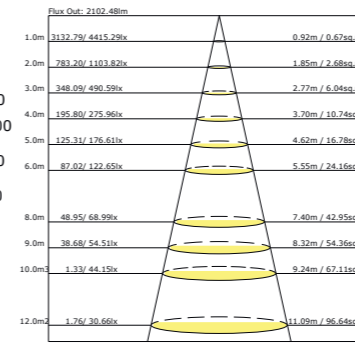

Luminous Intensity Distribution Curve

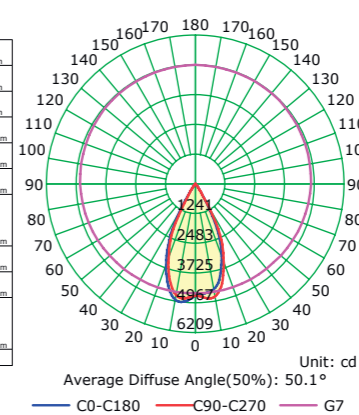

The Average Illuminance Effective Figure

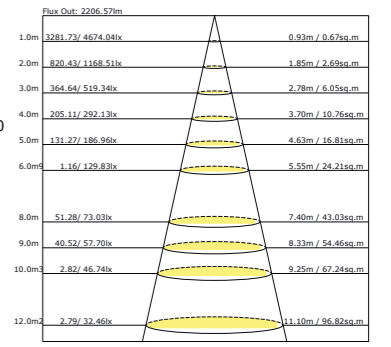

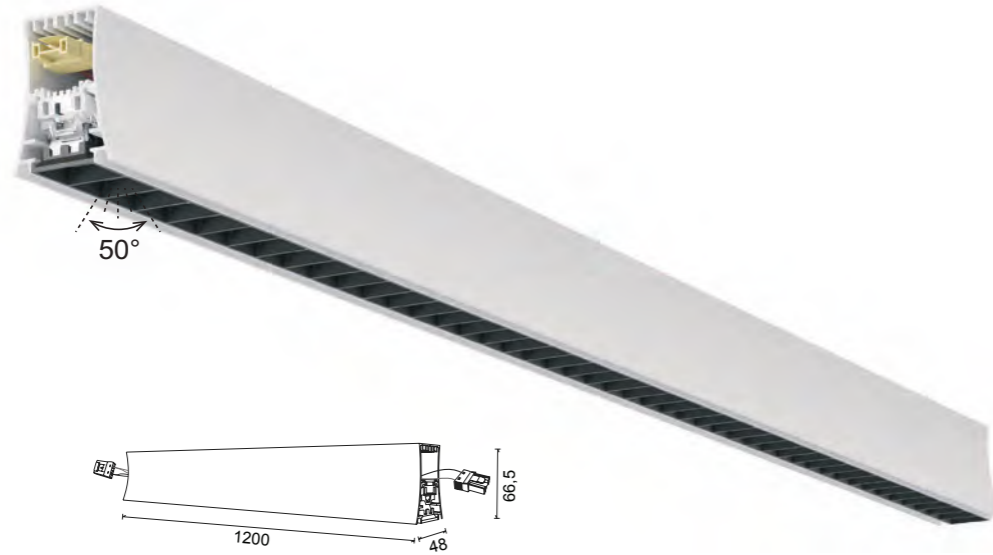

REFERENCE	K	LED WATT	LUMENS	FINISH
7548	3000K	38W	2650lm	Blanco-White
7549	4000K	38W	2800lm	Blanco-White
	UGR<16	220-240V- 50/60Hz	CRI≥ 80	Aluminio-Aluminium

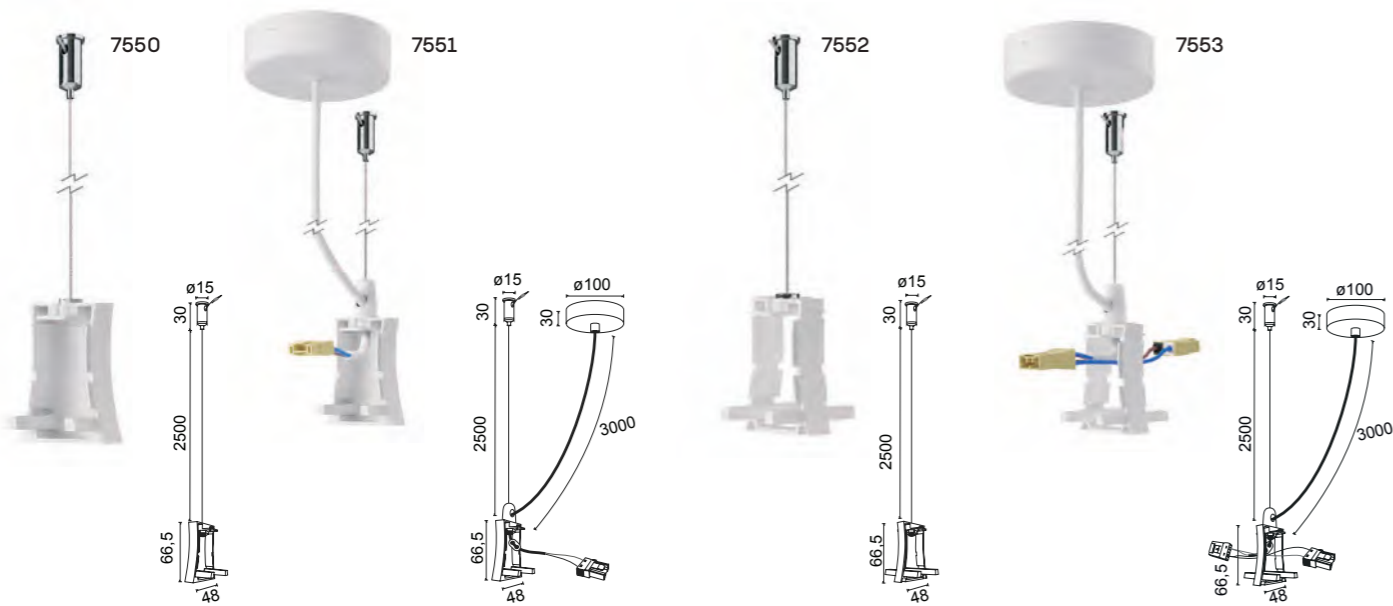

REFERENCE	Description
7550	Tapa lateral con cable fijación-Side cover white with fixing wire
7551	Tapa lateral con cable alimentación y florón-Side cover white with ac wire & rosette
7552	Conexión intermedia con cable fijación-Middle connection white with fixing wire
7553	Conexión intermedia con cable alimentación y florón - Middle connection white with ac wire & rosette



3000K 50° 38W

4000K 50° 38W

Luminous Intensity Distribution Curve

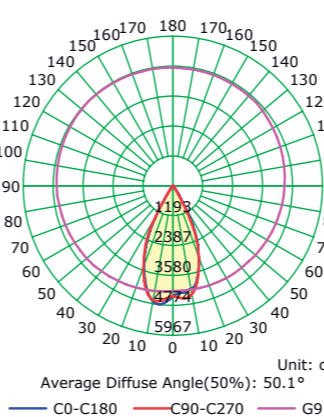

The Average Illuminance Effective Figure

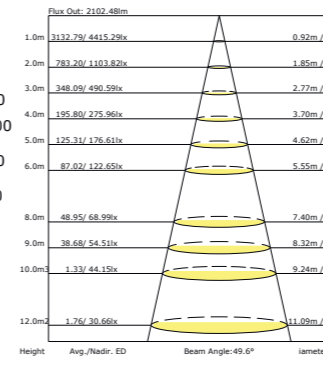

Luminous Intensity Distribution Curve

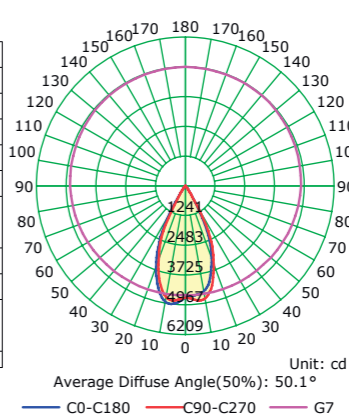

The Average Illuminance Effective Figure

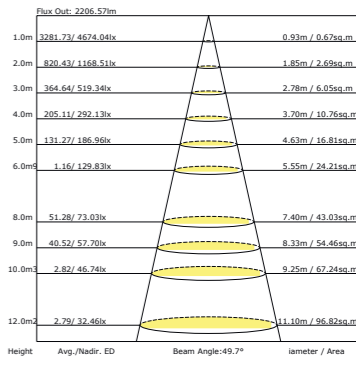

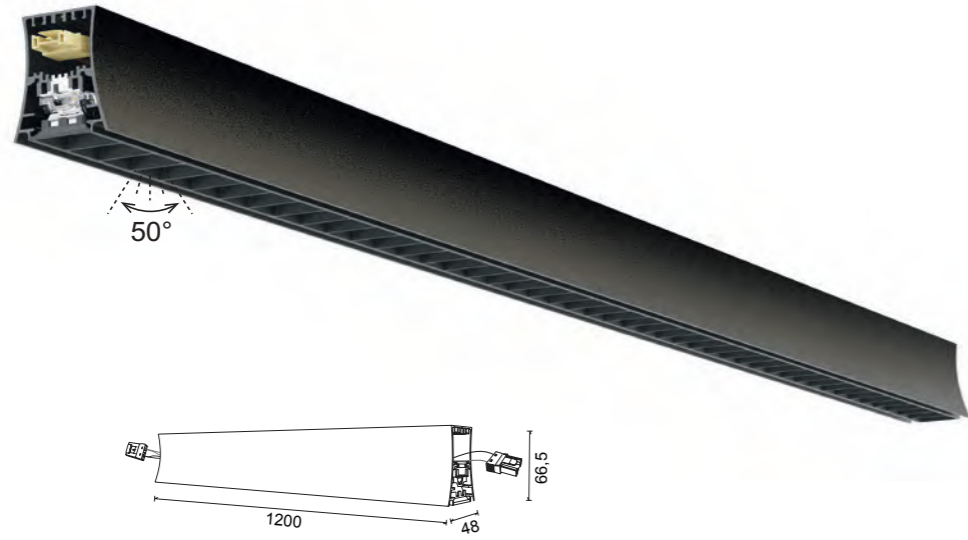

REFERENCE	K	LED WATT	LUMENS	FINISH
7554	3000K	38W	2650lm	Negro-Black
7555	4000K	38W	2800lm	Negro-Black
	UGR<16	220-240V- 50/60Hz CRI≥ 80		Aluminio-Aluminium

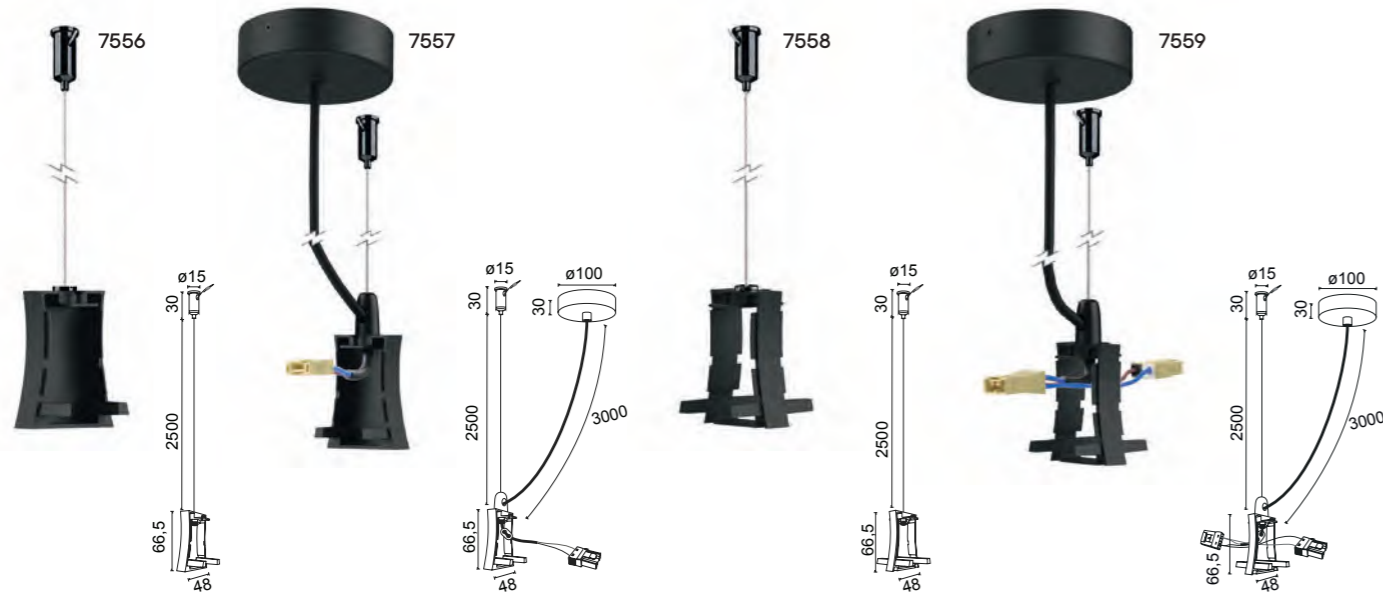

REFERENCE	Description
7556	Tapa lateral con cable fijación-Side cover white with fixing wire
7557	Tapa lateral con cable alimentación y florón-Side cover white with ac wire & rosette
7558	Conexión intermedia con cable fijación-Middle connection white with fixing wire
7559	Conexión intermedia con cable alimentación y florón - Middle connection white with ac wire & rosette



3000K 50° 38W

4000K 50° 38W

Luminous Intensity Distribution Curve

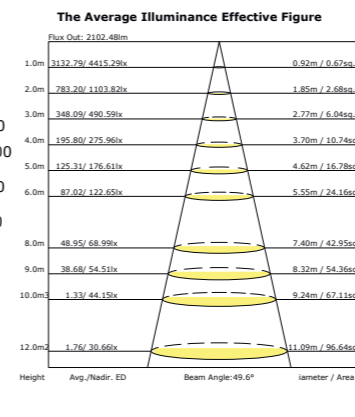
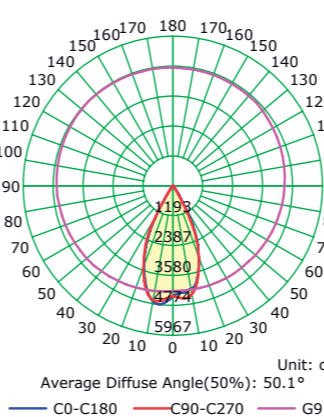

Luminous Intensity Distribution Curve

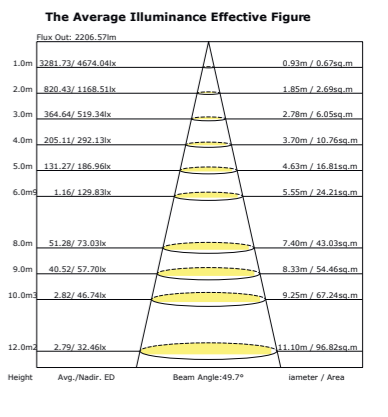
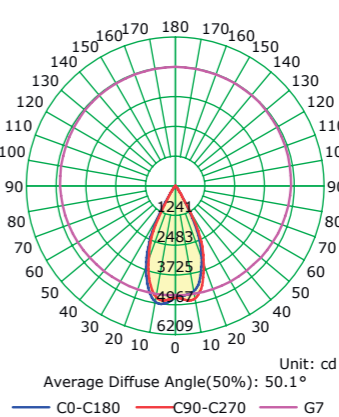

PAGODA
by David Villalba

Colgante-Pendant lamp

Indoor
UGR<16

CRI≥90

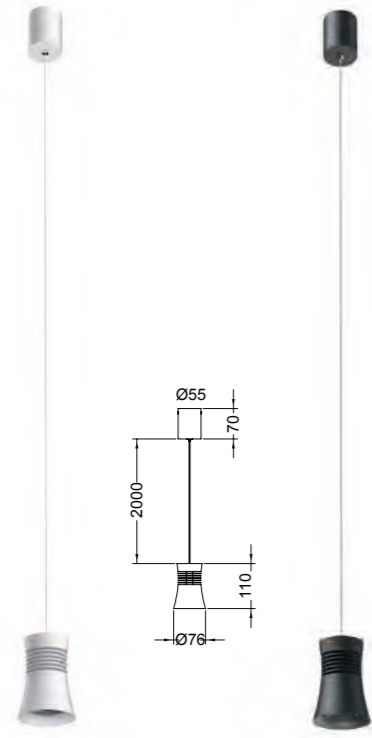

REFERENCE	K	LED WATT	LUMENS	FINISH
7784	3000K	12,5W	950lm	Blanco-White
7786	3000K	12,5W	950lm	Negro-Black
7785	4000K	12,5W	1050lm	Blanco-White
7787	4000K	12,5W	1050lm	Negro-Black
		UGR<16	220-240V~ 50/60Hz CRI:≥ 90	Aluminio-Aluminium



7788
pág.232



PAGODA
by David Villalba

Colgante-Pendant lamp

Indoor



REFERENCE	BULB (No incl)	FINISH
7790	1L x GU10	Blanco-White
7791	1L x GU10	Negro-Black
máx. 12W LED (No incl)		100-240V~50/60Hz Aluminio-Aluminium

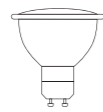
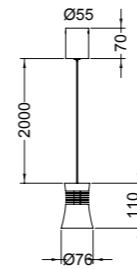

Bombillas recomendadas-Suggested bulbs

K	Wat LED	On/Off	Dimmable	Lumens
2700K	7W	R09254	R09257	510lm
3000K	7W	R09255	R09258	540lm
4000K	7W	R09256	R09259	570lm



ORION
by Hugo Tejada

Lámpara de techo-Pendant lamp

Indoor



REFERENCE	K	LED WATT	LUMENS	FINISH
7475	3000K	24W	1770 lm	Negro/cuero-Black/antique brass
		220-240V ~ 50/60Hz	CRI ≥ 80	Aluminio/Acrílico-Aluminium/Acrylic

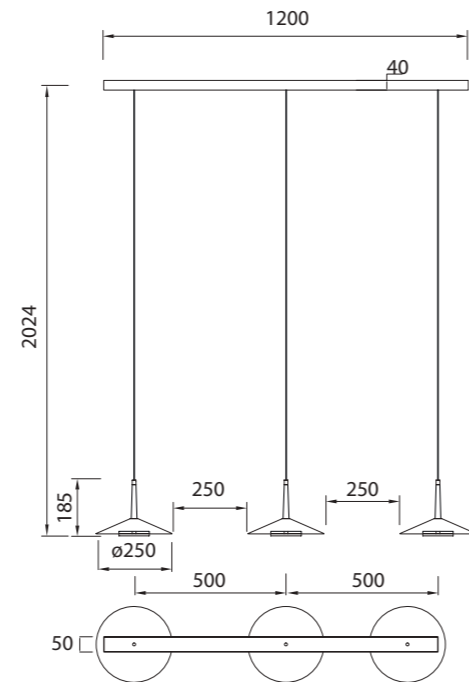

ORION
by Hugo Tejada

Lámpara de techo-Pendant lamp

Indoor

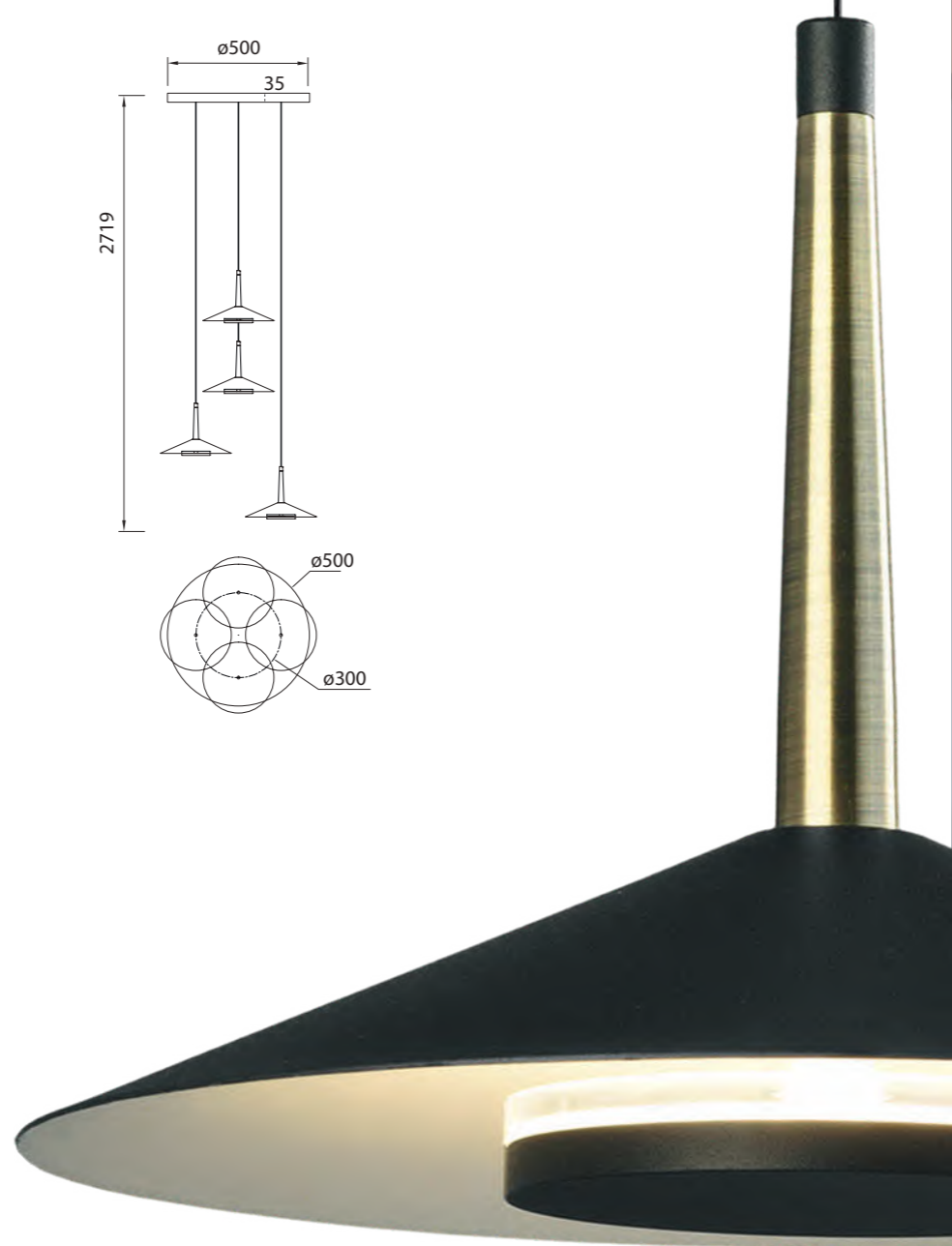

REFERENCE	K	LED WATT	LUMENS	FINISH
7476	3000K	32W	2360lm	Negro/cuero-Black/antique brass
		220-240V - 50/60Hz	CRi ≥ 80	Aluminio/Acrílico-Aluminium/Acrylic



8128
pág.22



ORION
by Hugo Tejada

Lámparas de techo-Pendant lamp

Indoor



REFERENCE	K	LED WATT	LUMENS	FINISH
7307	3000K	32W	2360lm	Negro/cuero-Black/antique brass
	12 und	reference 7308	included	Blocacables-WireLocker
		220-240V- 50/60Hz	CRi≥ 80	Aluminio/Acrílico-Aluminium/Acrylic

7308 Blocacables-WireLocker 1 und

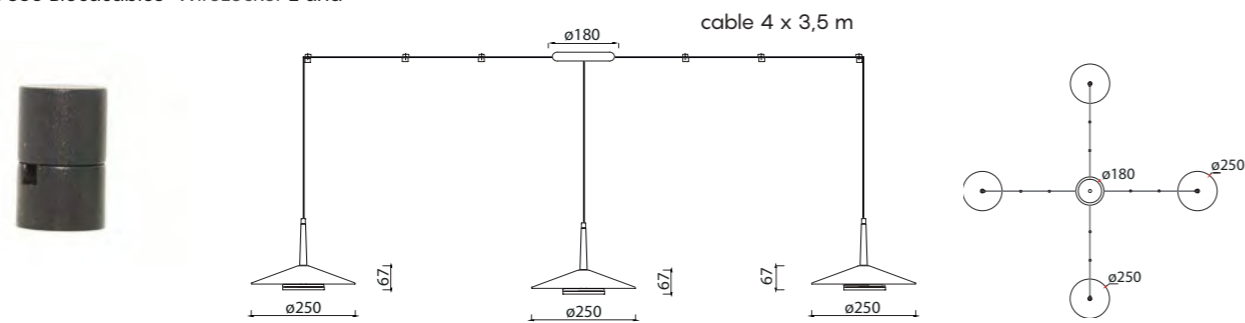

DRIVER
TÜV

Registered N° 007663331-0014



ORION
by Hugo Tejada

Lámparas de techo - Pendant lamp

Indoor

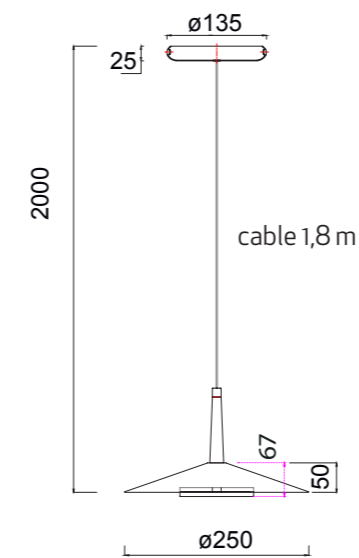

REFERENCE	K	LED WATT	LUMENS	FINISH
7305	3000K	8W	590lm	Negro/cuero-Black/antique brass
		220-240V - 50/60Hz	CRi ≥ 80	Aluminio/Acrílico-Aluminium/Acrylic



Registered N° 007663331-0014

DRIVER
TÜV

ORION
by Hugo Tejada

Lámparas de techo-Pendant lamp

Indoor



REFERENCE	K	LED WATT	LUMENS	FINISH
7306	3000K	16W	1180lm	Negro/cuero-Black/antique brass
	6 und	reference 7308	included	Blocacables-WireLocker
		220-240V ~ 50/60Hz	CRI ≥ 80	Aluminio/Acrílico-Aluminium/Acrylic

7308 Blocacables-WireLocker 1 und

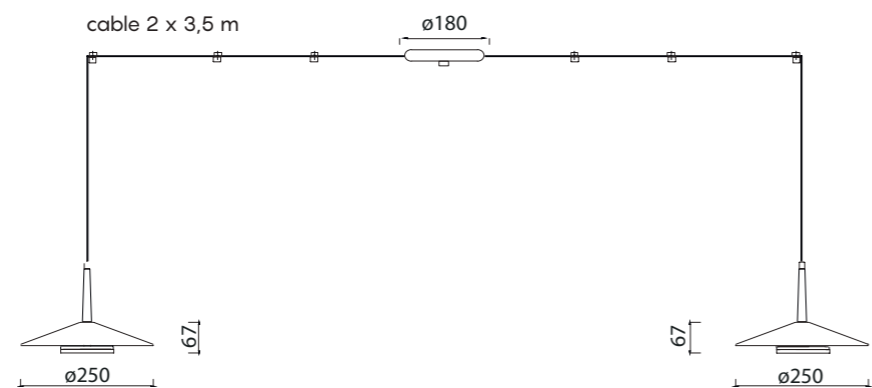



REFERENCE	K	LED WATT	LUMENS	FINISH
6825	3000K	21W	1475lm	Blanco Mate-Matt white
6826	3000K	21W	1475lm	Negro Mate-Matt black
220-240V~ 50/60Hz CRi ≥ 80				Aluminio-Aluminium

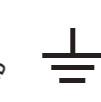
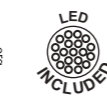
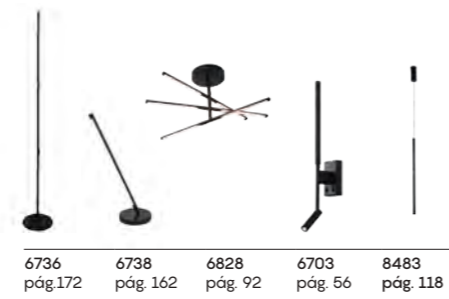
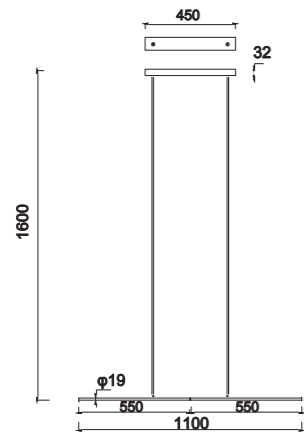

REFERENCE	BULB NO INCLUDED	FINISH	DIAMETER (ø):
5622	1L x E27	Blanco mate-Matt White	ø 120
5624	1L x E27	Plata-Silver	ø 120
5623	1L x E27	Blanco mate-Matt White	ø 95
5625	1L x E27	Plata-Silver	ø 95
máx. 20W LED (No incl)		100-240V~50/60Hz Metal-Metal	

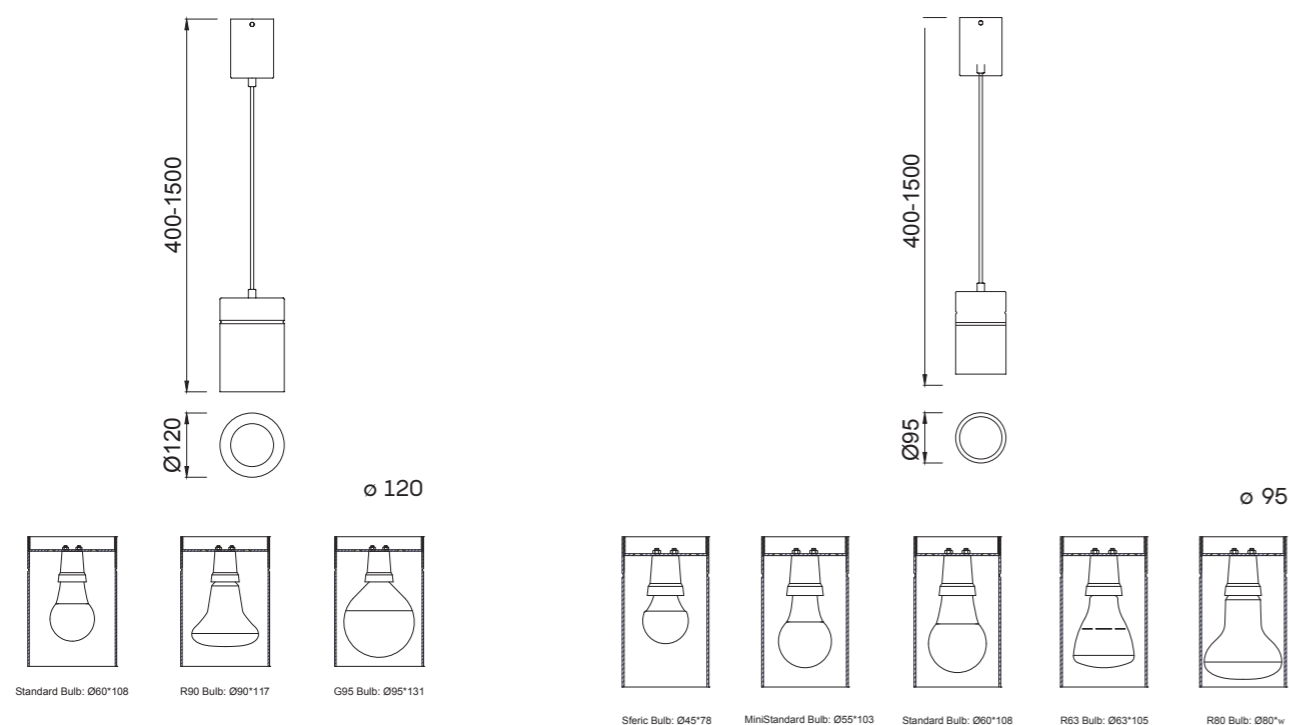

6044 pág. 236 6015 pág. 188 5626 pág. 190



FLORÓN empotrable

Base empotrada para colgantes - Recessed base for pendants

Indoor



REFERENCE	FINISH
7855	Blanco-White
7856	Negro-Black
7857	Plata-Silver
7858	Oro-Gold
7859	Cuero-Antique Brass
	Hierro-Iron

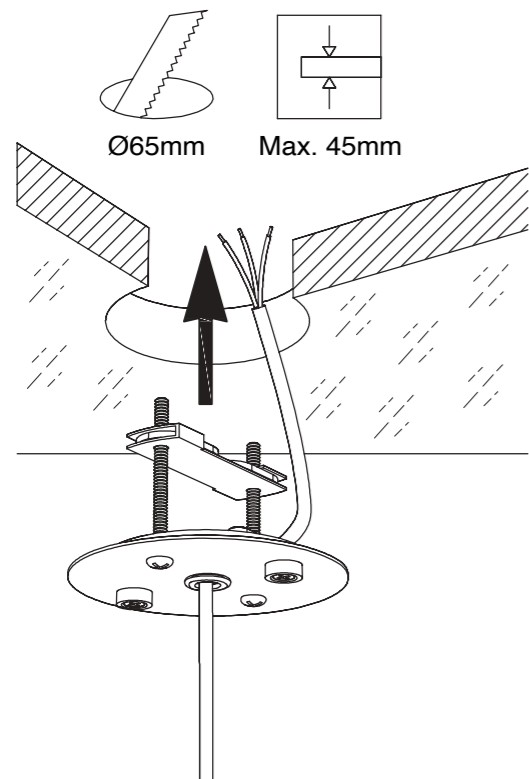
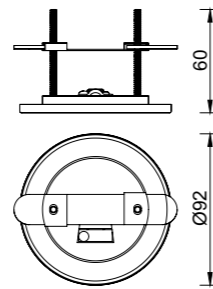

Sobremesa

Table lamp

Pie de salón

Floor lamp



REFERENCE	BULB (No incl)	FINISH	SIZE
8491	1L x GU10	Oro+Negro-Gold+Black	350 mm
8492	1L x GU10	Oro+Negro-Gold+Black	520 mm

máx. 10W LED (No incl) 100-240V~50/60Hz Aluminio-Aluminium

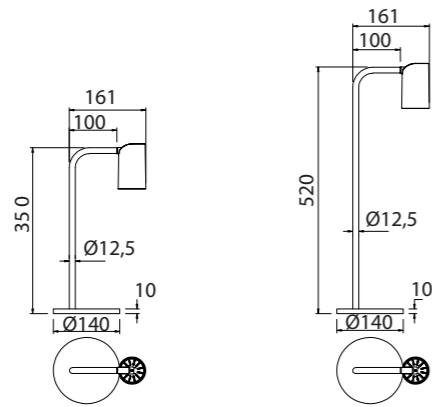

Bombillas recomendadas-Suggested bulbs

K	Wat LED	Reference
3000K	6W	R09196
4000K	6W	R09214
5000K	6W	R09197



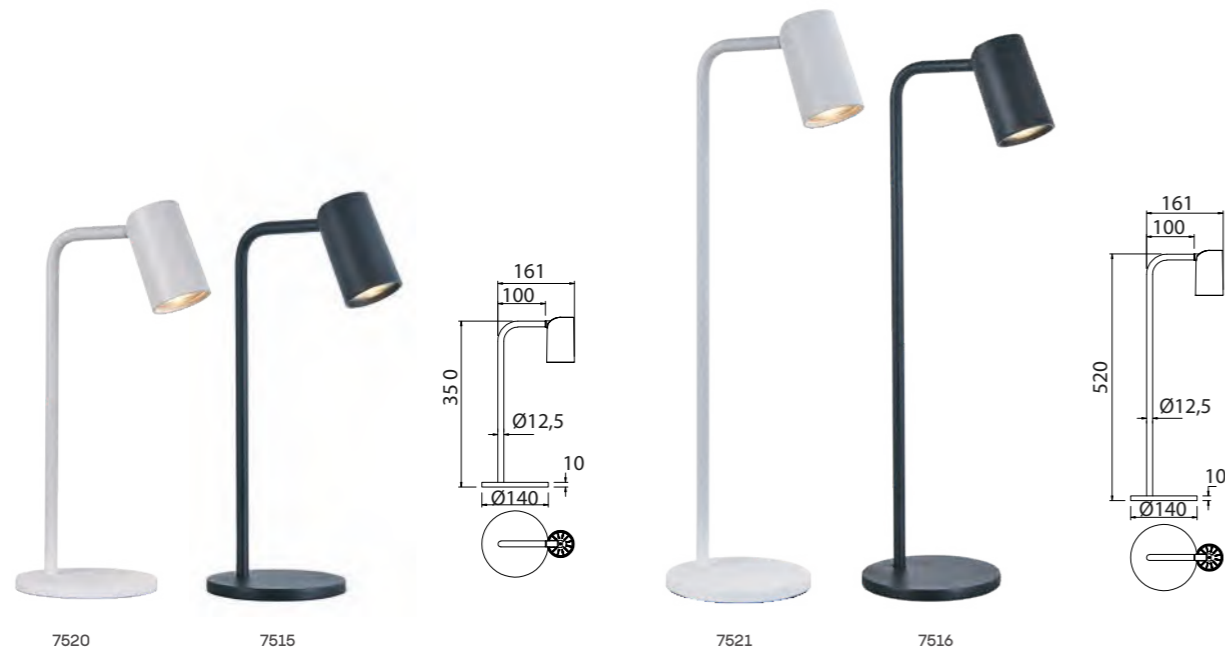

REFERENCE	BULB (No incl)	FINISH
7520	1L x GU10	Blanco arena-Sand white
7521	1L x GU10	Blanco arena-Sand white
7515	1L x GU10	Negro mate-Matt black
7516	1L x GU10	Negro mate-Matt black
máx. 10W LED (No incl)		100-240V~50/60Hz Aluminio-Aluminium



Bombillas recomendadas-Suggested bulbs

K	Wat LED	Reference
3000K	6W	R09196
4000K	6W	R09214
5000K	6W	R09197

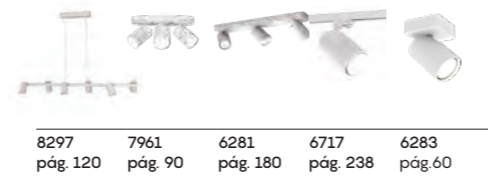

8297 pág. 120 7961 pág. 90 6281 pág. 180 6717 pág. 238 6283 pág. 60



8295 pág. 284 7522 pág. 168





REFERENCE	K	LED WATT	LUMENS	FINISH
7510	3000K	6W	390lm	Negro arena-Sand black
7511	3000K	6W	390lm	Negro arena-Sand black
220-240V~ 50/60Hz CRI:≥ 80				Aluminio-Aluminium



7512 pág. 170 7513 pág. 42





REFERENCE	K	LED WATT	LUMENS	FINISH
6737	3000K	11W	900lm	Blanco mate-Matt white
6738	3000K	11W	900lm	Negro mate-Matt black
220-240V~ 50/60Hz CRI:≥ 80				Aluminio-Aluminium

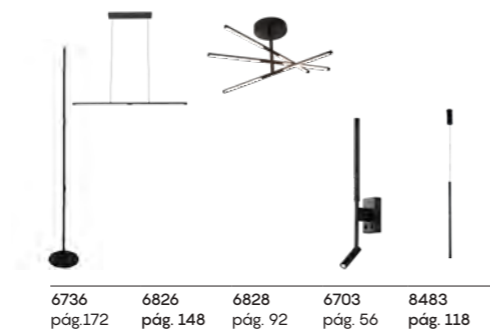

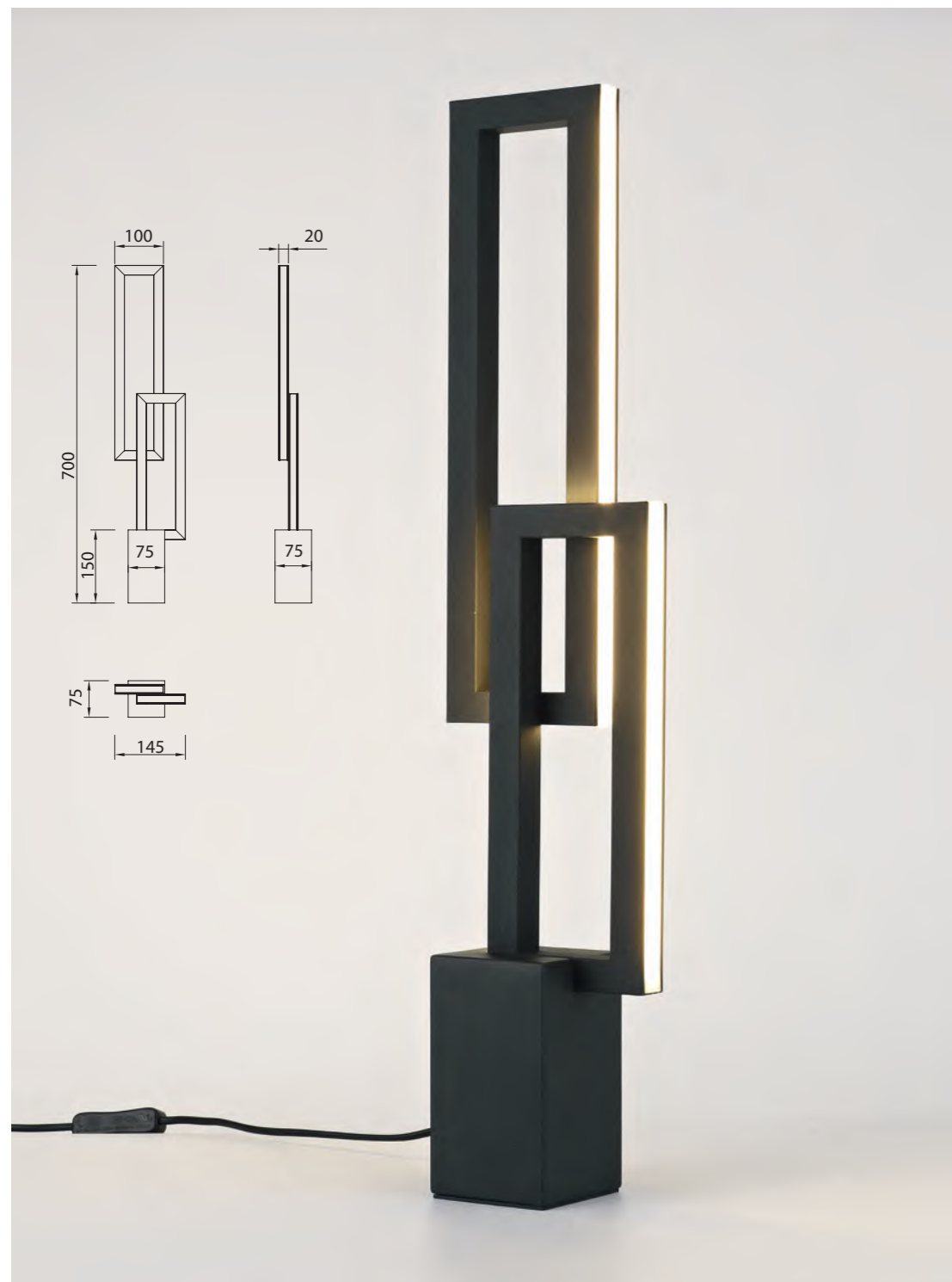

REFERENCE	K	LED WATT	LUMENS	FINISH
7464	3000K	18W	1380lm	Negro-Black
		100-240V~50/60Hz CRI:≥ 80		Aluminium/Iron/Acrílico-Aluminium/Iron/Acrylic



REFERENCE	K	LED WATT	LUMENS	FINISH
6562	3000K	18W	1380lm	Blanco-White
		100-240V~50/60Hz CRI:≥ 80		Aluminium/Iron/Acrílico-Aluminium/Iron/Acrylic

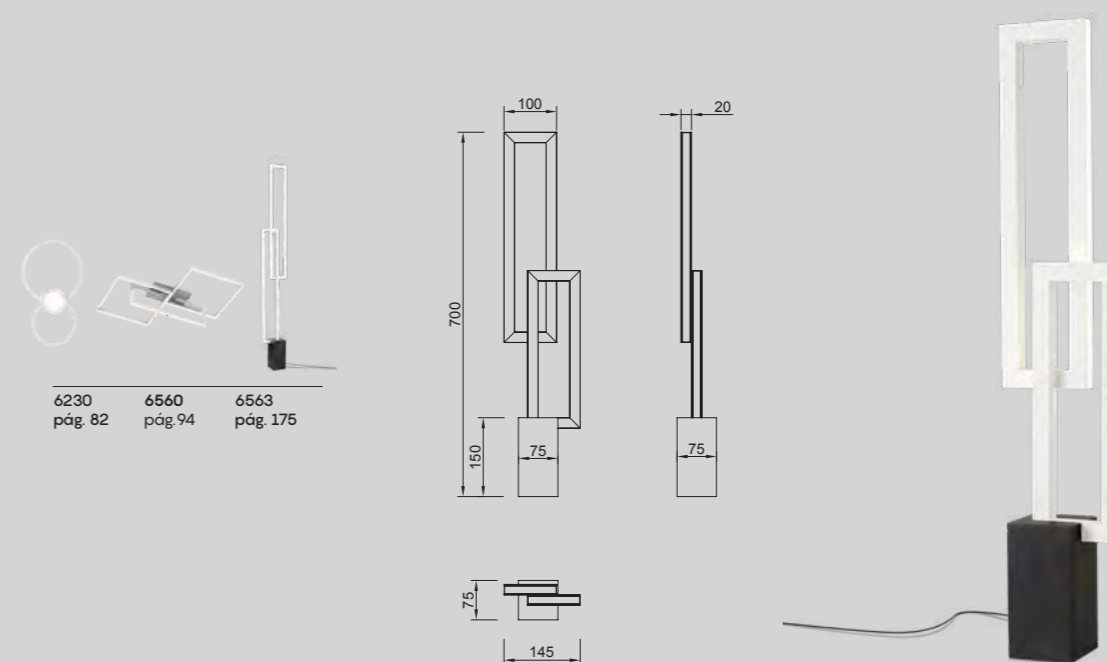

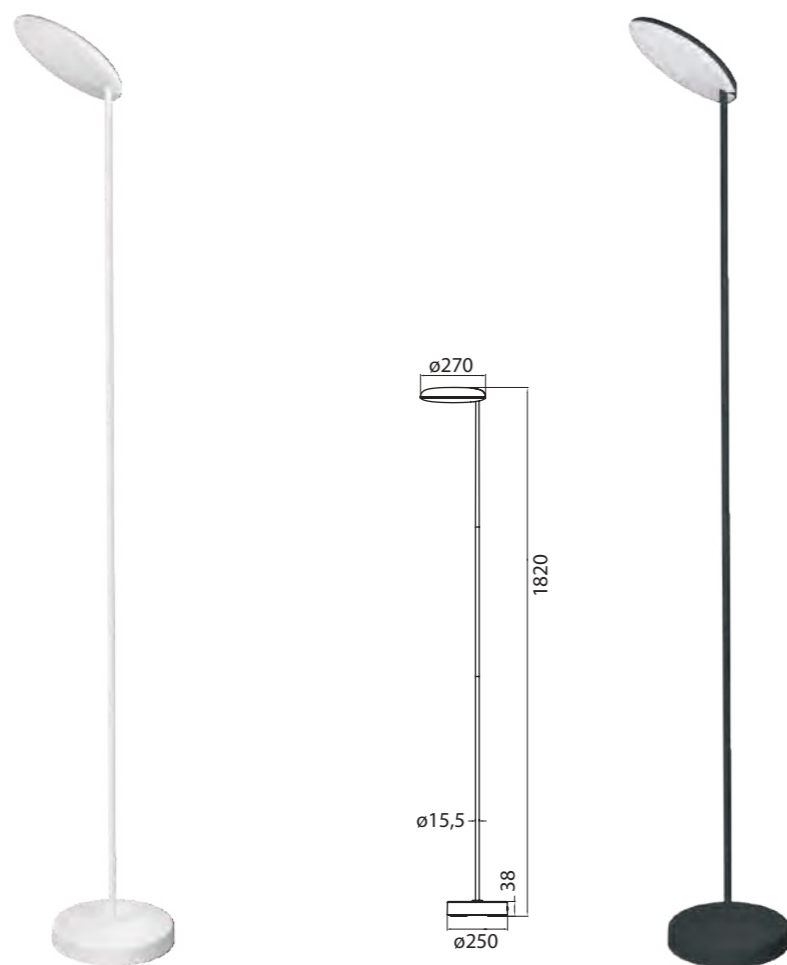

REFERENCE	CCT switch	LED WATT	LUMENS	FINISH
8510	3000K	30W	2100lm	Blanco-White
8511	3000K	30W	2100lm	Negro-Black
100-240V~ 50/60Hz CRI:≥ 80				Aluminio-Aluminium



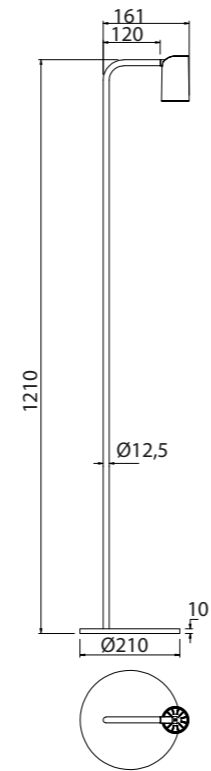

REFERENCE	BULB (No incl)	FINISH
7522	1L x GU10	Blanco arena-Sand white
7517	1L x GU10	Negro mate-Matt black
New 8493	1L x GU10	Oro+Negro-Gold+Black
máx. 10W LED (No incl) 100-240V ~50/60Hz Aluminio-Aluminium		

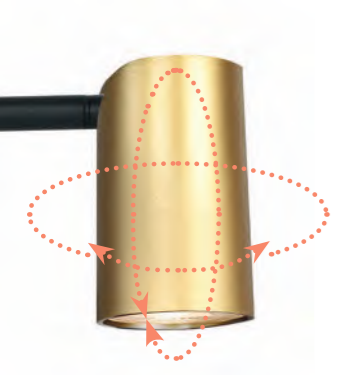
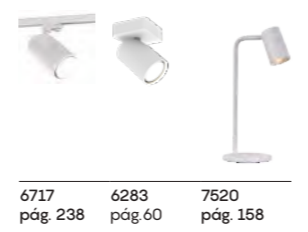
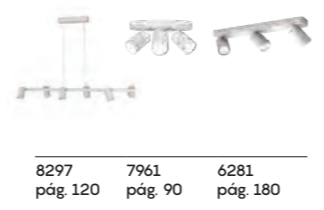

Bombillas recomendadas-Suggested bulbs

K	Wat LED	Reference
3000K	6W	R09196
4000K	6W	R09214
5000K	6W	R09197

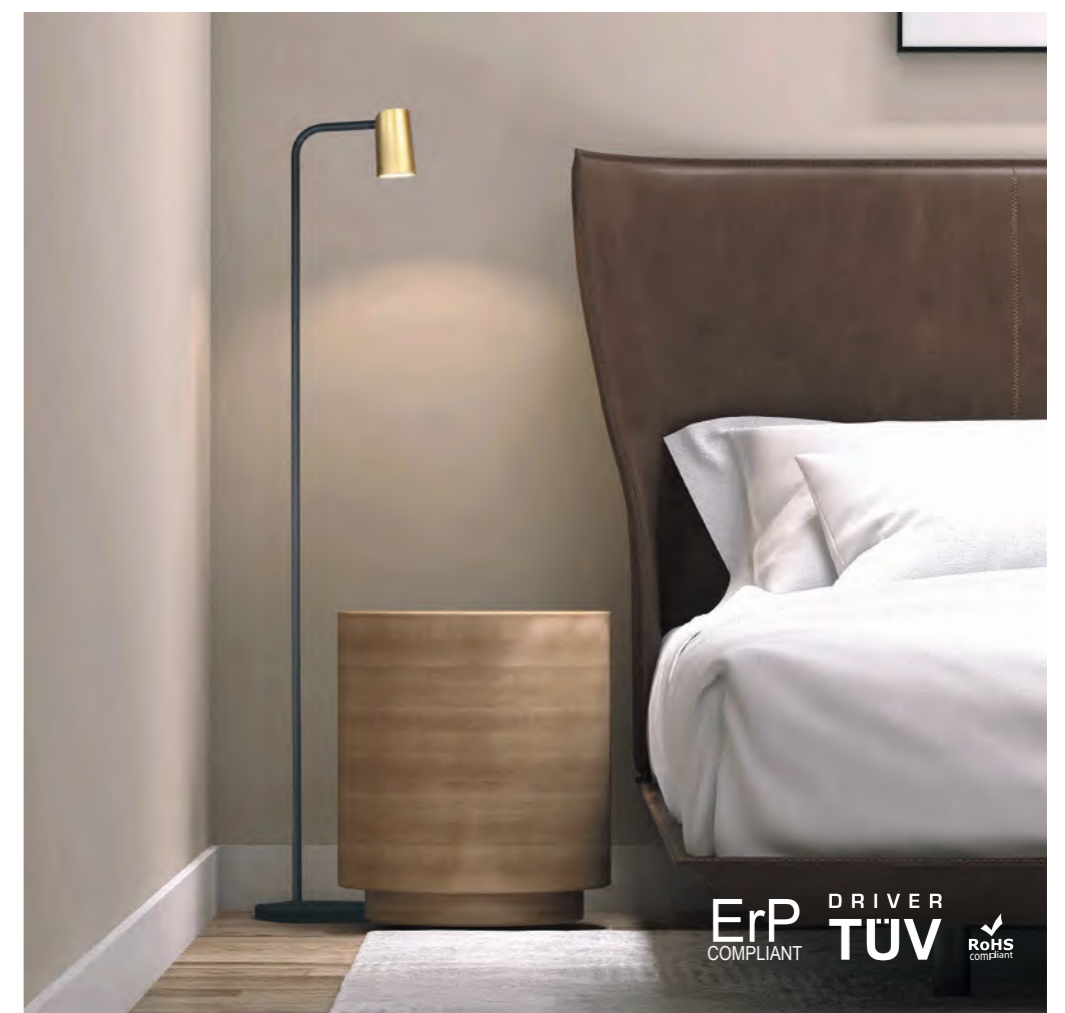

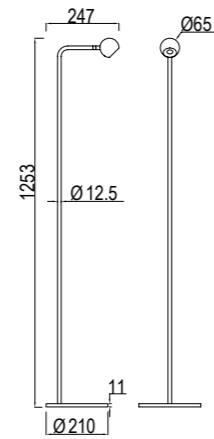

REFERENCE	K	LED WATT	LUMENS	FINISH
7512	3000K	6W	390lm	Negro arena-Sand black
220-240V~ 50/60Hz CRI:≥ 80				Aluminio-Aluminium



Indoor
360°

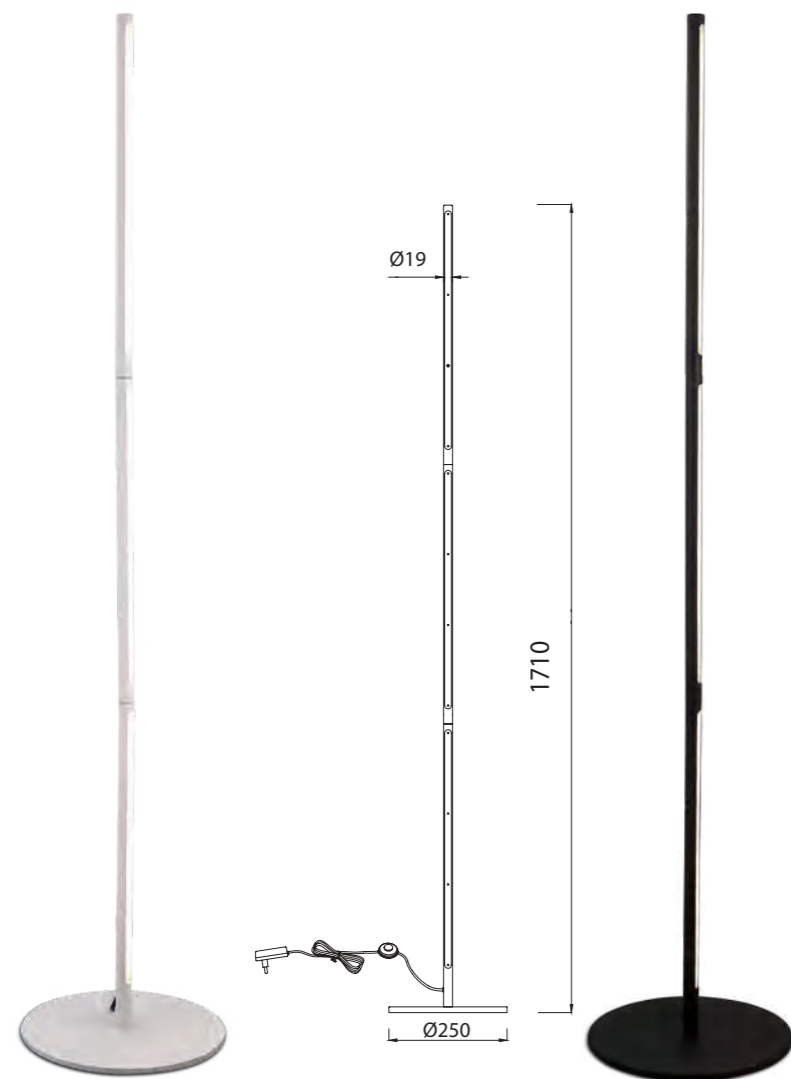

REFERENCE	K	LED WATT	LUMENS	FINISH
6735	3000K	25W	1950lm	Blanco mate-Matt white
6736	3000K	25W	1950lm	Negro mate-Matt black
220-240V~ 50/60Hz CRI:≥ 80				Aluminio-Aluminium



6738 pág. 162 6826 pág. 148 6828 pág. 92 6703 pág. 56 8483 pág. 118



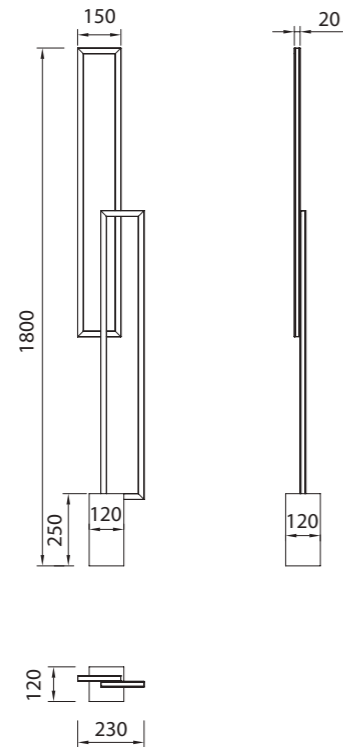

REFERENCE	K	LED WATT	LUMENS	FINISH
7465	3000K	48W	3800lm	Negro-Black
		220-240V~50/60Hz CRI:≥ 80		Aluminium/Iron/Acrílico-Aluminium/Iron/Acrylic

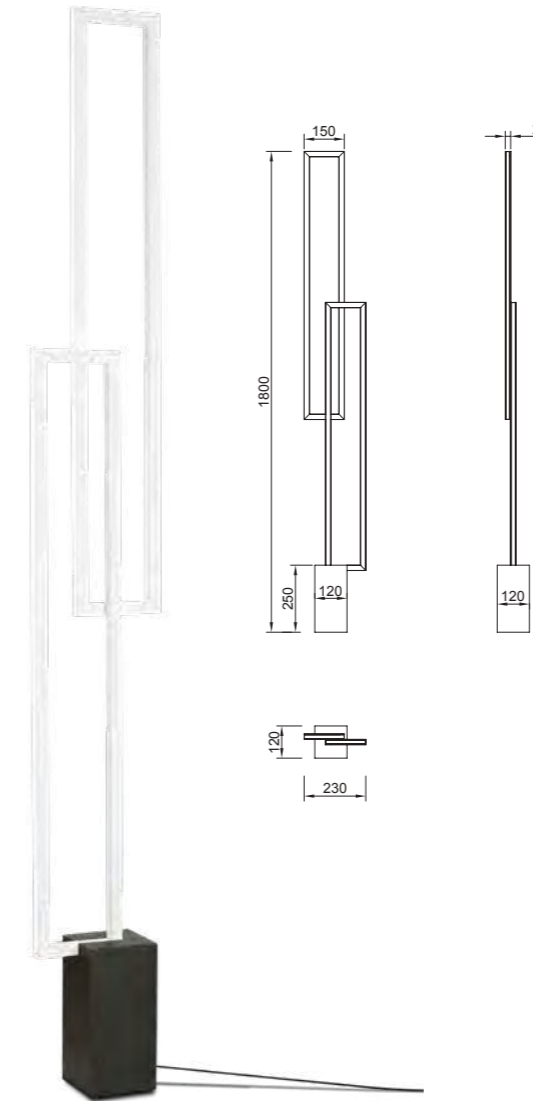

REFERENCE	K	LED WATT	LUMENS	FINISH
6563	3000K	48W	3800lm	Blanco-White
		220-240V~50/60Hz CRI:≥ 80		Aluminium/Iron/Acrílico-Aluminium/Iron/Acrylic

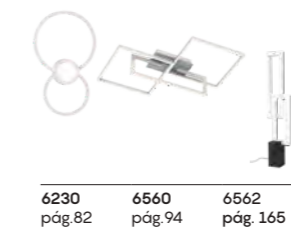

6230 pág.82 6560 pág.94 6562 pág.165



Foco Superficie

Spotlight

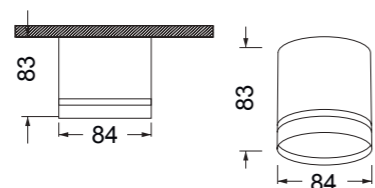

REFERENCE	BULB (No incl)	FINISH
8658	1L x GX53	Blanco-White
8659	1L x GX53	Negro-Black
máx. 12W LED (No incl) 100-240V-50/60Hz Aluminio-Aluminium		

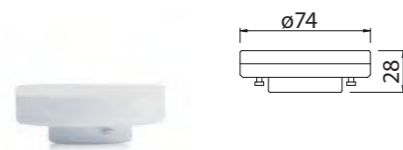

Bombillas recomendadas-Suggested bulbs

K	Wat LED	Ref	Lumens
3000K	12W	R09248	930lm
4000K	12W	R09249	960lm





REFERENCE	BULB (No incl)	FINISH
6283	1L x GU10	Blanco mate-Matt white
6713	1L x GU10	Negro mate-Matt black
New 8490	1L x GU10	Oro-Gold
6282	2L x GU10	Blanco mate-Matt white
6712	2L x GU10	Negro mate-Matt black
New 8489	2L x GU10	Oro-Gold
6281	3L x GU10	Blanco mate-Matt white
6711	3L x GU10	Negro mate-Matt black
New 8488	3L x GU10	Oro-Gold
6280	4L x GU10	Blanco mate-Matt white
6710	4L x GU10	Negro mate-Matt black
New 8487	4L x GU10	Oro-Gold
máx. 10W LED (No incl) 100-240V~50/60Hz Aluminio-Aluminium		

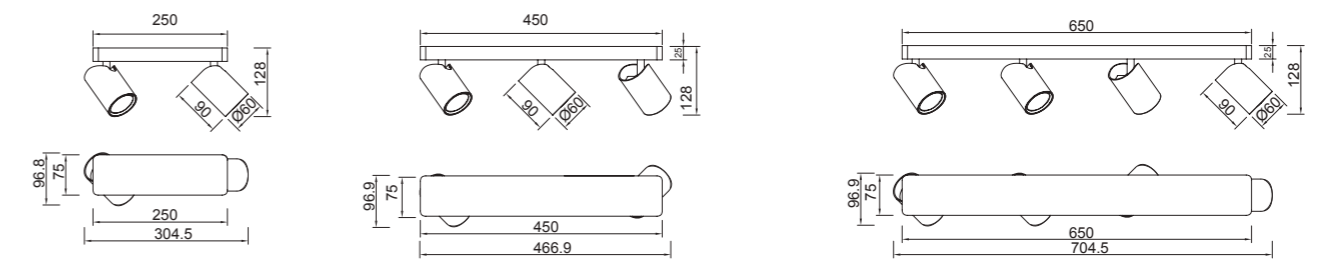

Bombillas recomendadas-Suggested bulbs

K	Wat LED	Reference
3000K	6W	R09196
4000K	6W	R09214
5000K	6W	R09197



7523 pág. 58 8295 pág.284



8297 pág. 120 7961 pág. 90 6717 pág. 238 6283 pág.60 7522 pág. 168 6281 pág. 180



GLACIAR

by Santiago Sevillano

Indoor



REFERENCE	K	LED WATT	LUMENS	FINISH	SIZES
7730	3000K	9W	700lm	Blanco-White	100
7731	4000K	9W	700lm	Blanco-White	100
7732	3000K	9W	700lm	Blanco-White	170
7733	4000K	9W	700lm	Blanco-White	170
7734	3000K	9W	700lm	Blanco-White	240
7735	4000K	9W	700lm	Blanco-White	240
				220-240V - 50/60Hz CRI≥ 80	Acrílico-Arcylic

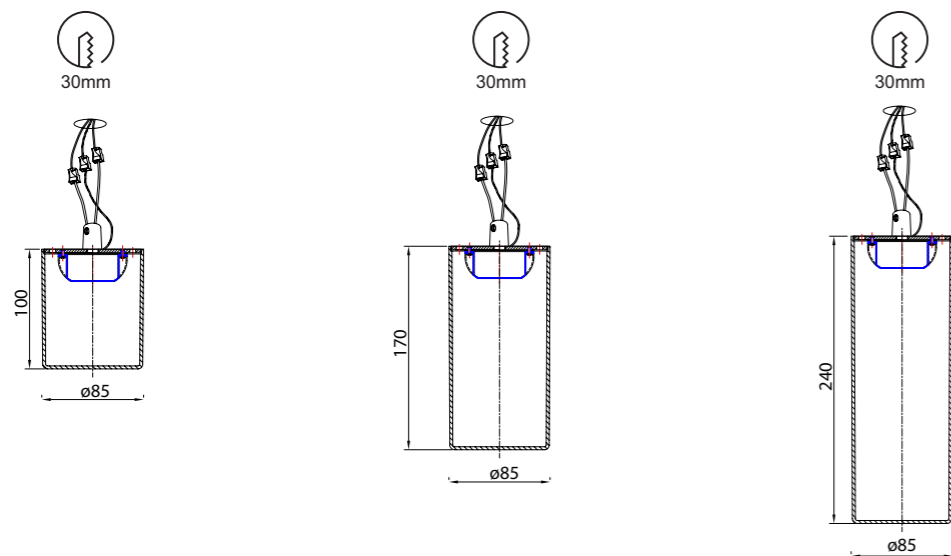

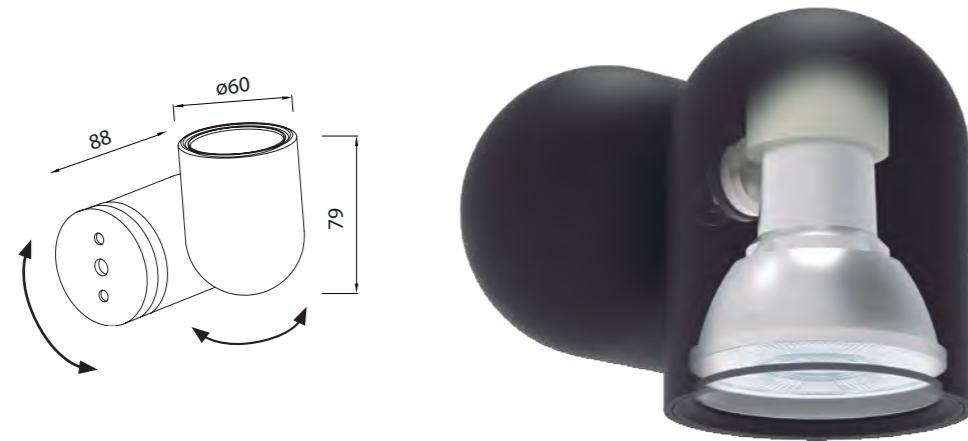

REFERENCE	BULB (No incl)	FINISH
7294	1L x GU10	Blanco-White
7295	1L x GU10	Negro-Black
máx. 12W LED (No incl) 100-240V-50/60Hz Aluminio-Aluminium		

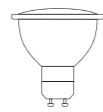

Bombillas recomendadas-Suggested bulbs

K	Wat LED	On/Off	Dimmable	Lumens
2700K	7W	R09254	R09257	510lm
3000K	7W	R09255	R09258	540lm
4000K	7W	R09256	R09259	570lm



Registered N° 007663331-0013



7937
pág. 124

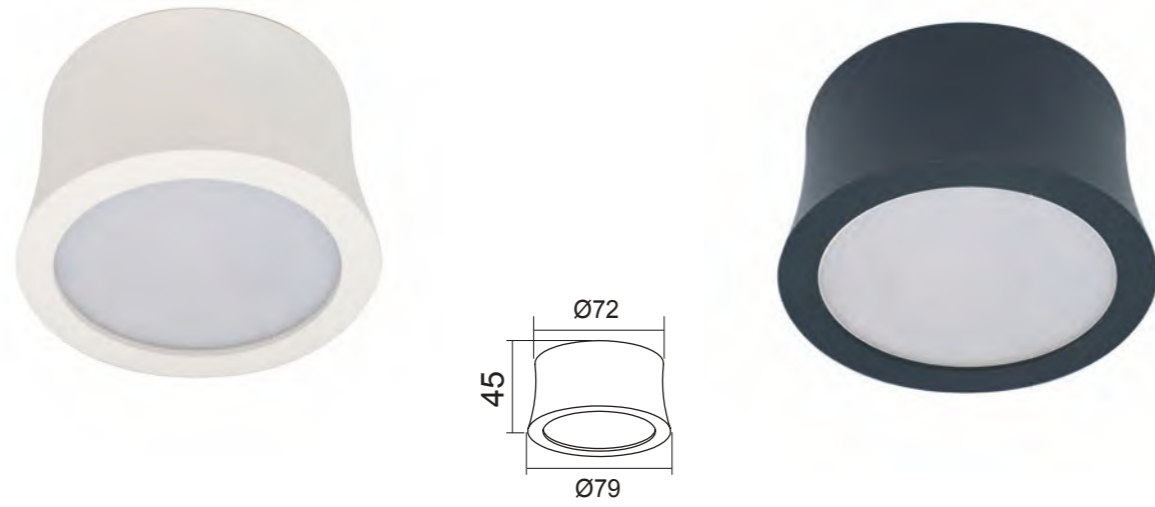

REFERENCE	K	LED WATT	LUMENS	FINISH
6830	3000K	7W	520lm	Blanco arena-Sand white
6833	3000K	7W	520lm	Negro arena-Sand black
6832	4000K	7W	560lm	Blanco arena-Sand white
6831	4000K	7W	560lm	Negro arena-Sand black
220-240V-50/60Hz CRI:≥ 80				Aluminio-Aluminium

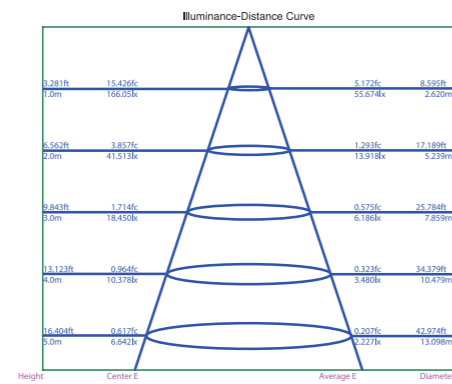
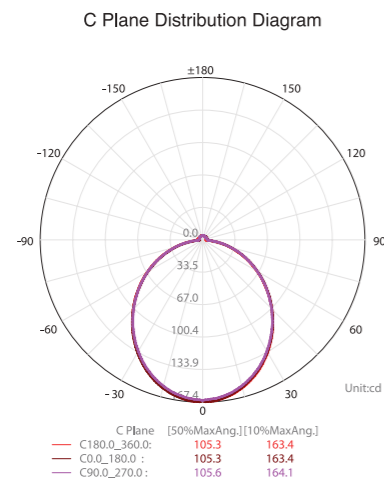

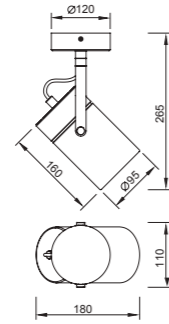

REFERENCE	BULB NO INCLUDED	FINISH
6015	1L x E27	Blanco-White
6016	1L x E27	Plata-Silver
	máx. 20W LED (No incl)	100-240V ~50/60Hz Metal-Metal

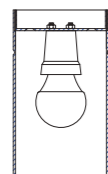

Spheric Bulb: Ø45*78

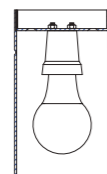

MiniStandard Bulb: Ø55*103

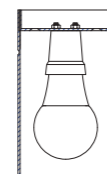

Standard Bulb: Ø60*108

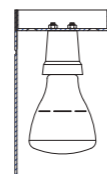

R63 Bulb: Ø63*105

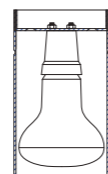

R80 Bulb: Ø80*116



6044 pág. 236 5622 pág. 150





REFERENCE	BULB NO INCLUDED	FINISH	DIAMETER (ø):
5626	1L x E27	Blanco-White	ø 120
5628	1L x E27	Plata-Silver	ø 120
5627	1L x E27	Blanco-White	ø 90
5629	1L x E27	Plata-Silver	ø 90
máx. 20W LED (No incl)		100-240V ~ 50/60Hz Metal-Metal	

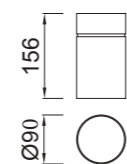
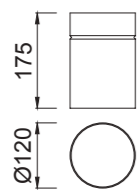

Standard Bulb: Ø60*108
R90 Bulb: Ø90*117
G95 Bulb: Ø95*131

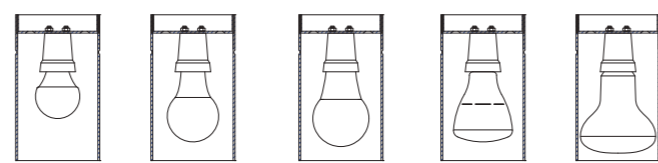

Spheric Bulb: Ø45*78
MiniStandard Bulb: Ø55*103
Standard Bulb: Ø60*108
R63 Bulb: Ø63*105
R80 Bulb: Ø80*116



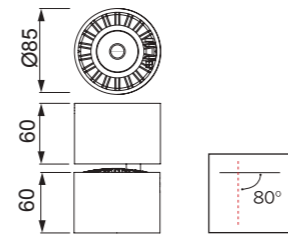

REFERENCE	K	LED WATT	LUMENS	FINISH
C0085	3000K	12W	1040lm	Blanco mate-Matt white
		220-240V-50/60Hz CRI: ≥ 80		Aluminio-Aluminium

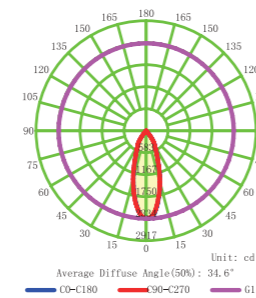
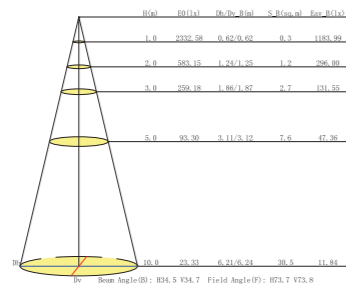

8322-8339

8381-8385

8382-8386

8315-8332

8316-8333-8816

8317-8334-8817

8384-8388

8328-8345

8326-8343

8325-8342

8318-8335-8818

8319-8336-8819

8323-8340

8324-8341

8390-8392

8389-8391-8823

8383-8387

8327-8344

8442-8444

8441-8443-8824

8445-8446-8825

8329-8346-8822

8320-8337-8820

8321-8338-8821

MAGNETO 48V

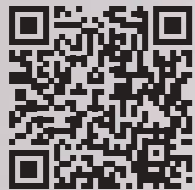

MODO DE USO 



INSTRUCCIONES
INSTRUCTIONS



MAGNETO 48V

New

Indoor

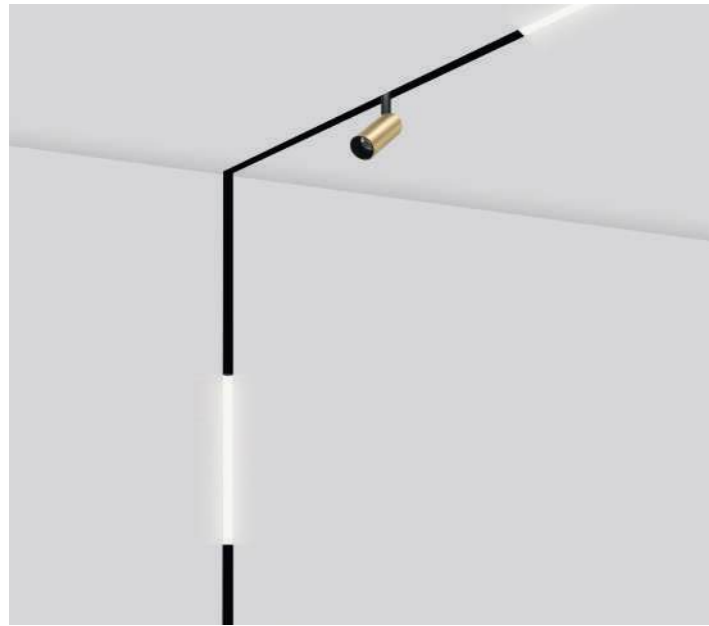

MODO DE USO 



INSTRUCCIONES
INSTRUCTIONS



MAGNETO 48V

New

Indoor

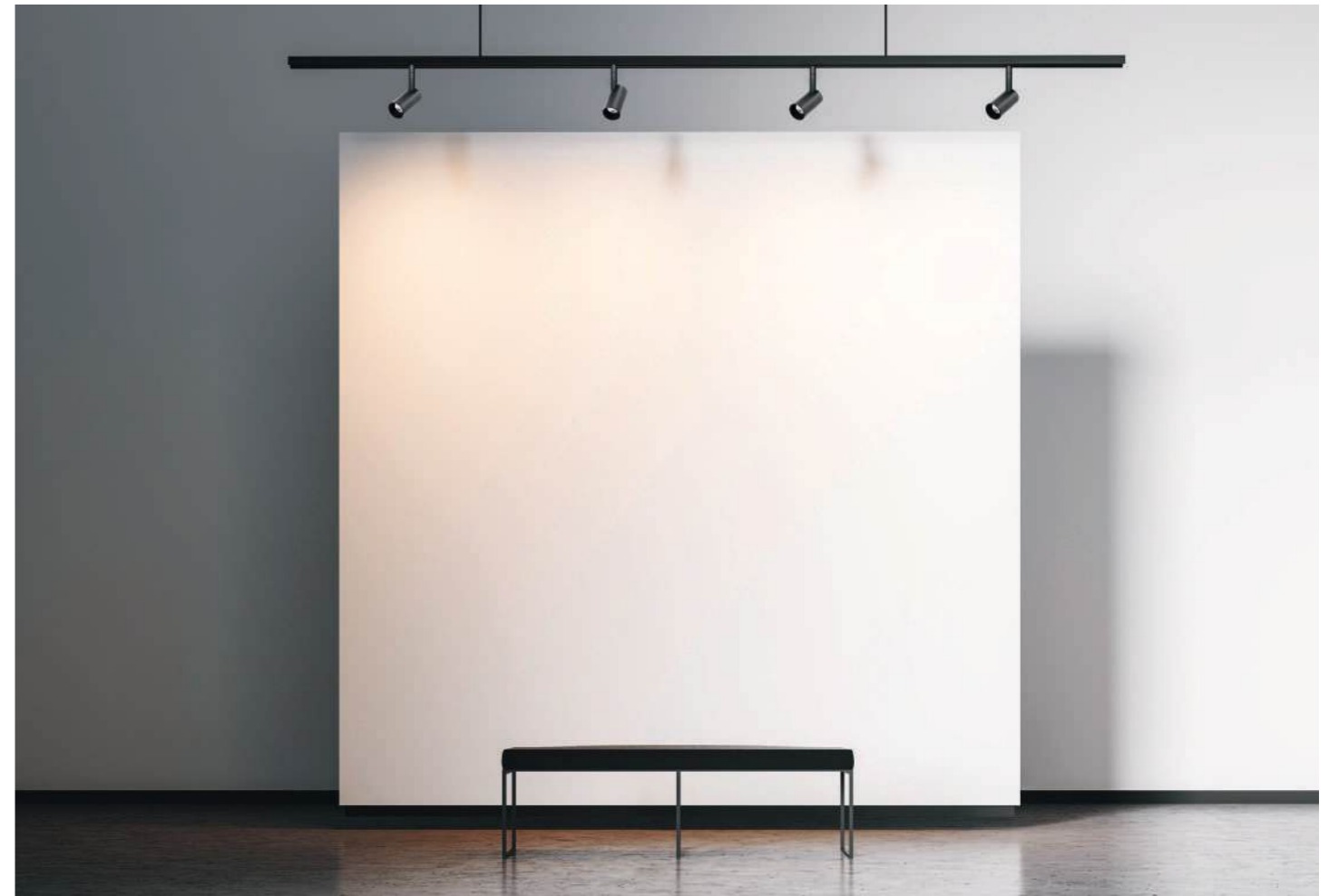
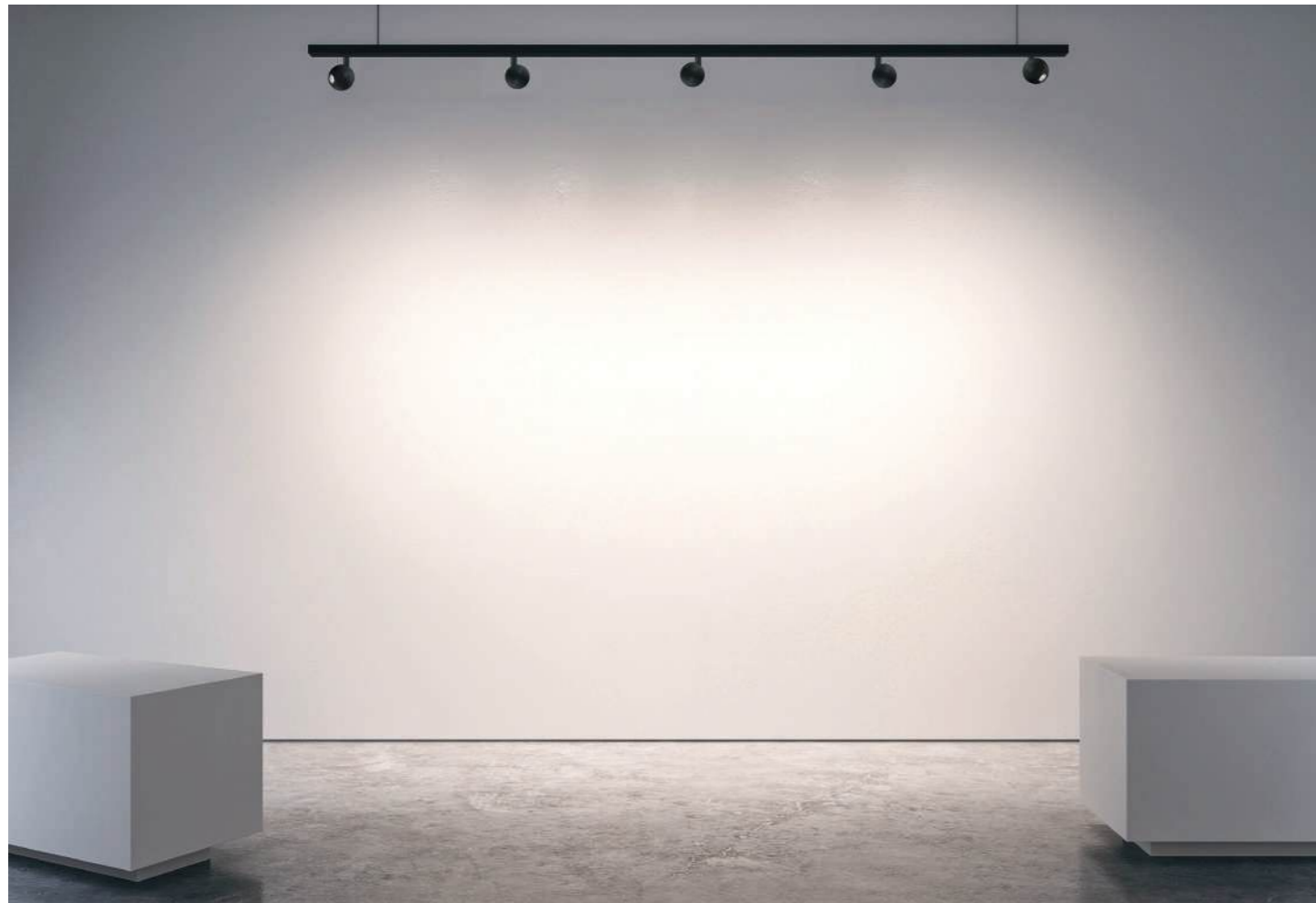



MAGNETO 48V

New

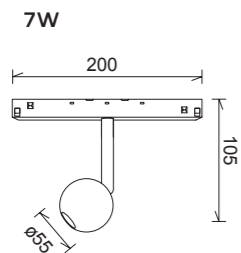
Indoor



REFERENCE	K	LED WATT	BEAM ANGLE	LUMENS	FINISH	
8328	3000K	7W	38°	560lm	Negro-Black	On-off
8384	3000K	7W	38°	560lm	Oro-Gold	On-off
8345	3000K	7W	38°	560lm	Negro-Black	Dimmable 
8388	3000K	7W	38°	560lm	Oro-Gold	Dimmable 
				48V CRI≥ 90	Aluminio-Aluminium	

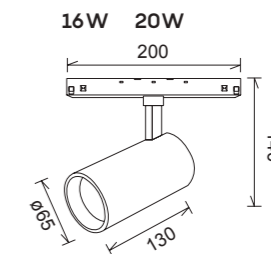
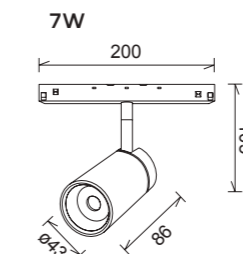
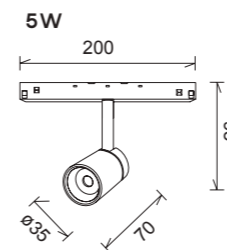

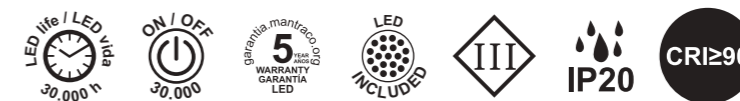

REFERENCE	K	LED WATT	BEAM ANGLE	LUMENS	FINISH	
8315	3000K	5W	50°	400lm	Negro-Black	On-off
8381	3000K	5W	50°	400lm	Oro-Gold	On-off
8316	3000K	7W	38°	560lm	Negro-Black	On-off
8382	3000K	7W	38°	560lm	Oro-Gold	On-off
New 8816	4000K	7W	38°	585lm	Negro-Black	On-off
8317	3000K	20W	38°	1600lm	Negro-Black	On-off
New 8817	4000K	20W	38°	1650lm	Negro-Black	On-off
8332	3000K	5W	50°	400lm	Negro-Black	Dimmable 
8385	3000K	5W	50°	400lm	Oro-Gold	Dimmable 
8333	3000K	7W	38°	560lm	Negro-Black	Dimmable 
8386	3000K	7W	38°	560lm	Oro-Gold	Dimmable 
8334	3000K	16W	38°	1300lm	Negro-Black	Dimmable 
				48V CRI≥ 90	Aluminio-Aluminium	



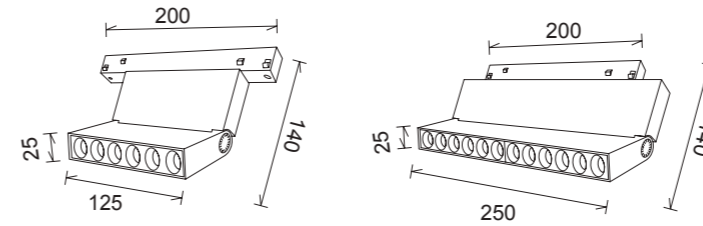
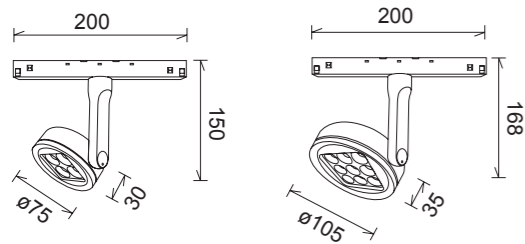

MAGNETO 48V

New



REFERENCE	K	LED WATT	BEAM ANGLE	LUMENS	FINISH	
8325	3000K	10W	50°	800lm	Negro-Black	On-off
8326	3000K	20W	50°	1600lm	Negro-Black	On-off
8342	3000K	10W	50°	800lm	Negro-Black	Dimmable 
8343	3000K	20W	50°	1600lm	Negro-Black	Dimmable 
				48V CRI≥ 90	Aluminio-Aluminium	

REFERENCE	K	LED WATT	BEAM ANGLE	LUMENS	FINISH	
8323	3000K	10W	50°	800lm	Negro-Black	On-off
8324	3000K	20W	50°	1600lm	Negro-Black	On-off
8340	3000K	10W	50°	800lm	Negro-Black	Dimmable 
8341	3000K	20W	50°	1600lm	Negro-Black	Dimmable 
				48V CRI≥ 90	Aluminio-Aluminium	

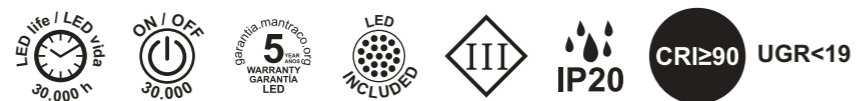

MAGNETO 48V

New

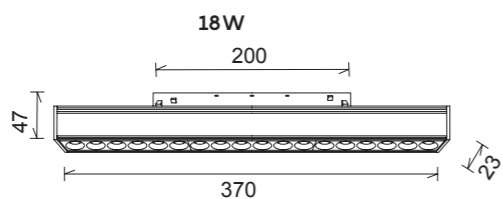
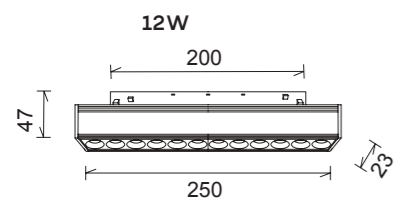

REFERENCE	K	LED WATT	BEAM ANGLE	LUMENS	FINISH	
8320	3000K	12W	50°	960lm	Negro-Black	On-off
New 8820	4000K	12W	50°	1000lm	Negro-Black	On-off
8321	3000K	18W	50°	1440lm	Negro-Black	On-off
New 8821	4000K	18W	50°	1500lm	Negro-Black	On-off
8337	3000K	12W	50°	960lm	Negro-Black	Dimmable
8338	3000K	18W	50°	1440lm	Negro-Black	Dimmable
				48V CRI≥ 90	Aluminio-Aluminium	



Angulo difusor-Corner diffuser



8322-8339



8318-8818-8335



8319-8819-8336

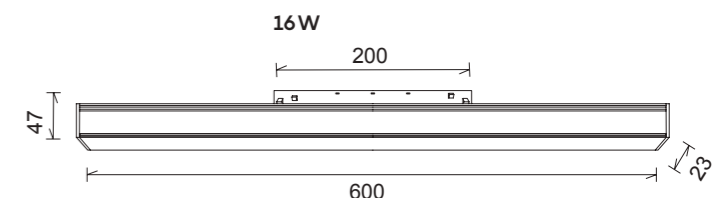
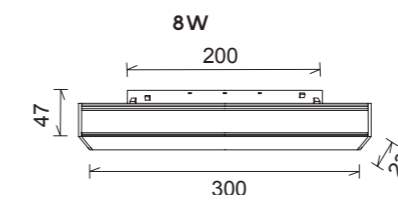
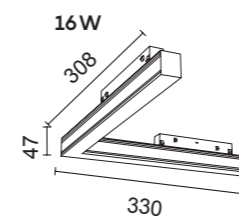

REFERENCE	K	LED WATT	BEAM ANGLE	LUMENS	FINISH	
8322	3000K	16W	120°	1280lm	Negro-Black	On-off
8339	3000K	16W	120°	1280lm	Negro-Black	Dimmable
8318	3000K	8W	120°	640lm	Negro-Black	On-off
New 8818	4000K	8W	120°	665lm	Negro-Black	On-off
8319	3000K	16W	120°	1280lm	Negro-Black	On-off
New 8819	4000K	16W	120°	1340lm	Negro-Black	On-off
8335	3000K	8W	120°	640lm	Negro-Black	Dimmable
8336	3000K	16W	120°	1280lm	Negro-Black	Dimmable
				48V CRI≥ 90	Aluminio-Aluminium	





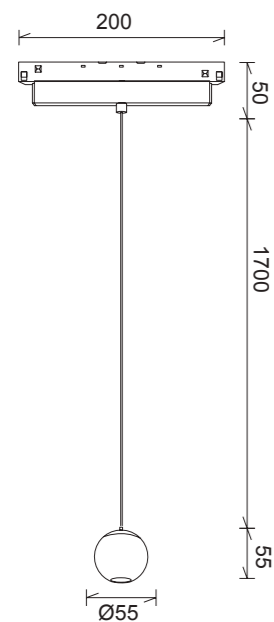

MAGNETO 48V

New

Indoor



REFERENCE	K	LED WATT	BEAM ANGLE	LUMENS	FINISH	
8327	3000K	7W	38°	560lm	Negro-Black	On-off
8383	3000K	7W	38°	560lm	Oro-Gold	On-off
8344	3000K	7W	38°	560lm	Negro-Black	Dimmable 
8387	3000K	7W	38°	560lm	Oro-Gold	Dimmable 
				48V CRI≥ 90	Aluminio-Aluminium	

REFERENCE	K	LED WATT	BEAM ANGLE	LUMENS	FINISH	
8441	3000K	10W	110°	800lm	Negro-Black	On-off
New 8824	4000K	10W	110°	840lm	Negro-Black	On-off
8442	3000K	10W	110°	800lm	Oro-Gold	On-off
8443	3000K	10W	110°	800lm	Negro-Black	Dimmable 
8444	3000K	10W	110°	800lm	Oro-Gold	Dimmable 
				48V CRI≥ 90	Aluminio-Aluminium	



MAGNETO 48V

New

Indoor

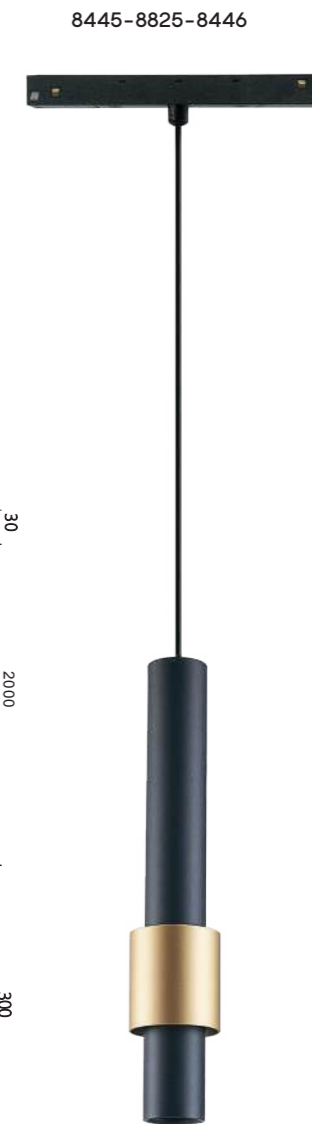
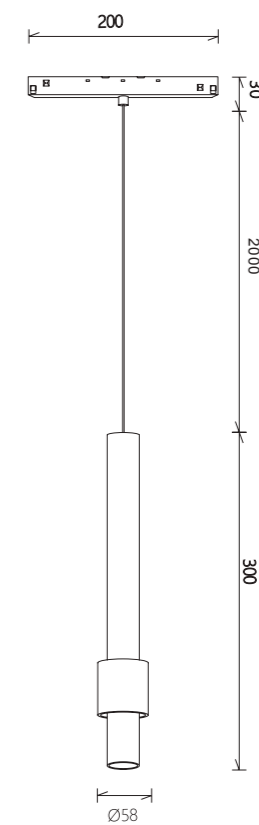
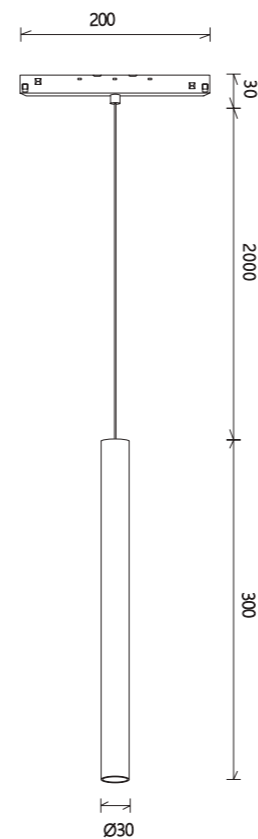
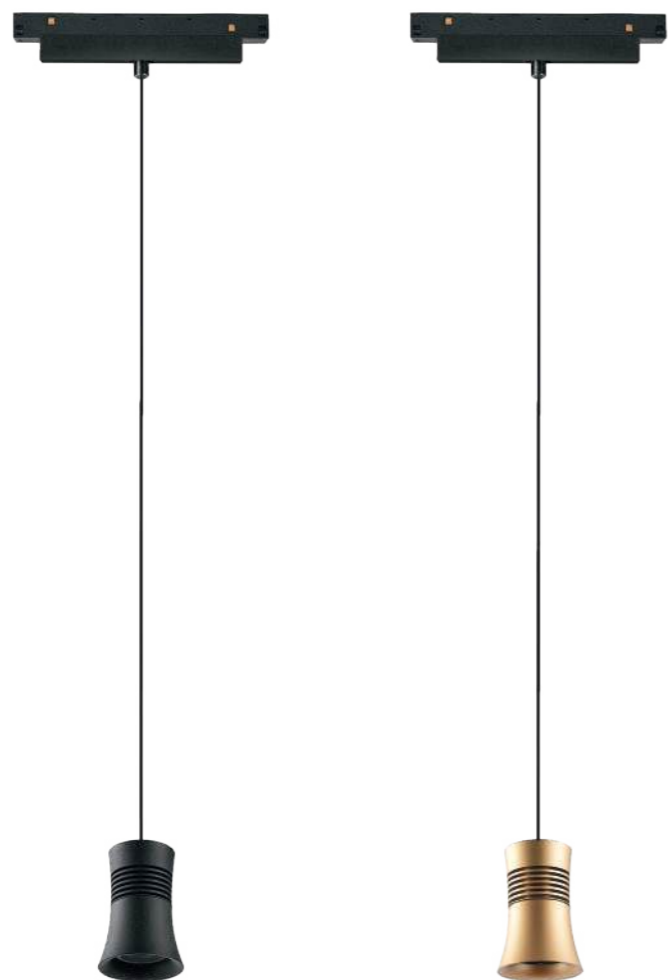
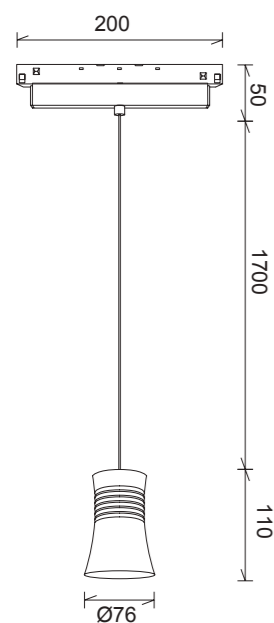

REFERENCE	K	LED WATT	BEAM ANGLE	LUMENS	FINISH	
8389	3000K	12W	38°	950lm	Negro-Black	On-off
New 8823	4000K	12W	38°	1000lm	Negro-Black	On-off
8390	3000K	12W	38°	950lm	Oro-Gold	On-off
8391	3000K	12W	38°	950lm	Negro-Black	Dimmable
8392	3000K	12W	38°	950lm	Oro-Gold	Dimmable
				48V CRI≥ 90	Aluminio-Aluminium	

REFERENCE	K	LED WATT	BEAM ANGLE	LUMENS	FINISH	
8329	3000K	5W	38°	400lm	Negro-Black	On-off
New 8822	4000K	5W	38°	420lm	Negro-Black	On-off
8346	3000K	5W	38°	400lm	Negro-Black	Dimmable
8445	3000K	7W	38°	560lm	Oro/Negro-Gold/black	On-off
New 8825	4000K	7W	38°	585lm	Oro/Negro-Gold/black	On-off
8446	3000K	7W	38°	560lm	Oro/Negro-Gold/black	Dimmable
				48V CRI≥ 90	Aluminio-Aluminium	

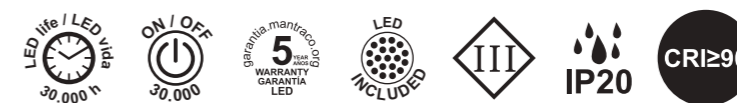

Carril de empotrar-*Recessed track*

Indoor

Carril de superficie-*Surface mounted track*



INSTRUCCIONES
INSTRUCTIONS

Los carriles empotrados permiten una fusión total, creando infinitas soluciones para la iluminación de espacios interiores, con el refinamiento y la discreción de un sistema que ofrece un diseño moderno, minimalista y sereno.

The recessed rails allow a total fusion, creating unlimited solutions for the lighting of interior spaces, with the refinement and discretion of a system that offers a modern, minimalist and serene design.

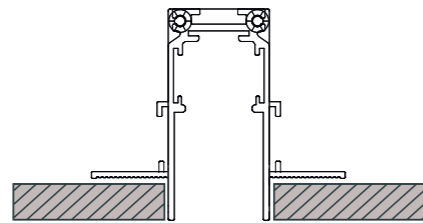

Los carriles de superficie son soluciones diseñadas para cualquier zona de instalación. Su particular diseño lo convierte en protagonista absoluto del espacio.

Surface rails are solutions designed for any installation area. Its particular design makes it the absolute protagonist of the space.



MAGNETO 48V

Indoor

SURFACE TRACK

8300 Track length 1000 mm

8301 Track length 2000 mm

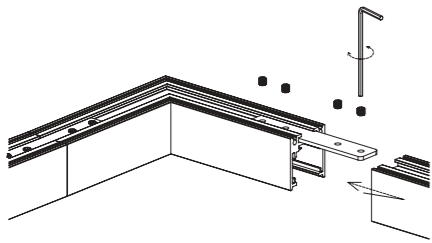

TRACK ACCESSORIES

8304 L-joint 90° plates incl.

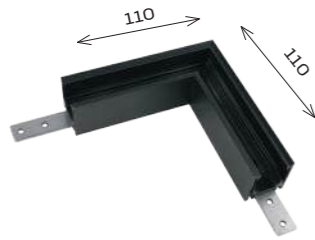

8305 Wall to wall connector (in) plates incl.

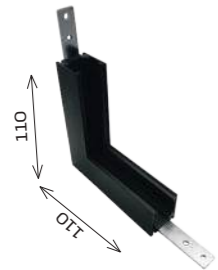

8306 Wall to wall connector (out) plates incl.



8303 Top track connection plate



8314 Live end (connector)



8313 Live end (feeder)



8302 Set 2 end caps



8377 Suspension kits (2 wires)



■ Brown +48V
■ Blue -48V

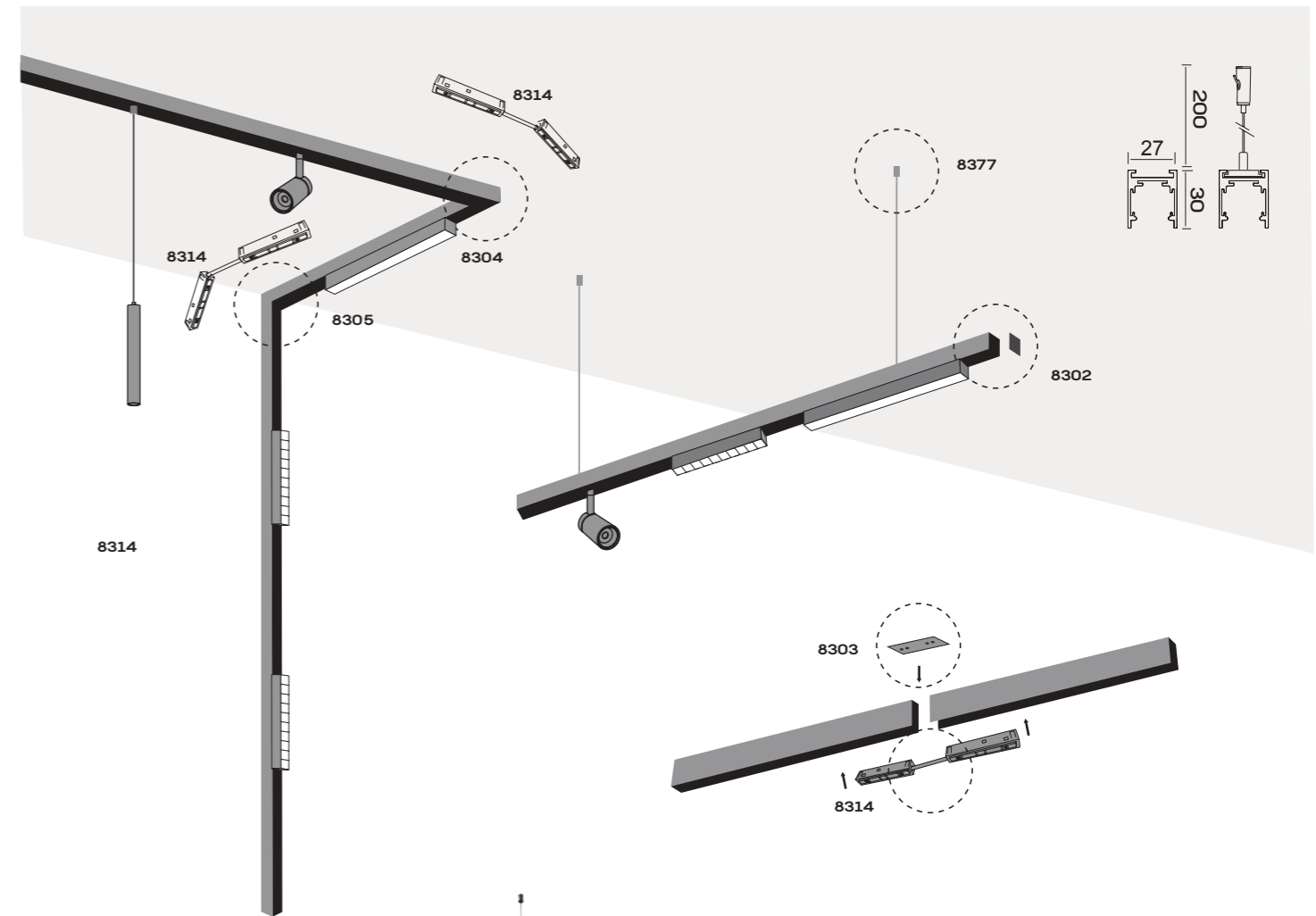
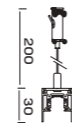

SURFACE TRACK

8371 Track length 1000 mm

8372 Track length 2000 mm

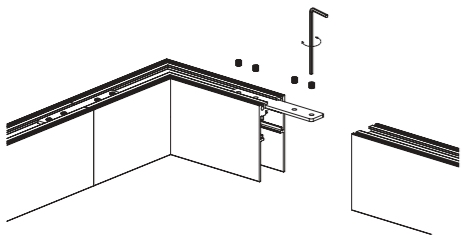

TRACK ACCESSORIES

8374 L-joint 90° plates incl.

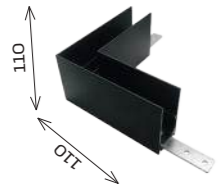

8375 Wall to wall connector (in) plates incl.

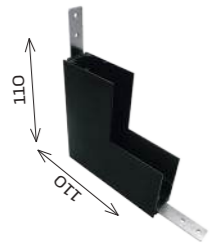

8376 Wall to wall connector (out) plates incl.

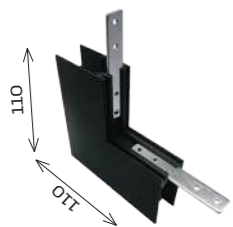

8303 Top track connection plate



8314 Live end (connector)



8313 Live end (feeder)



8373 Set 2 end caps



8377 Suspension kits (2 wires)

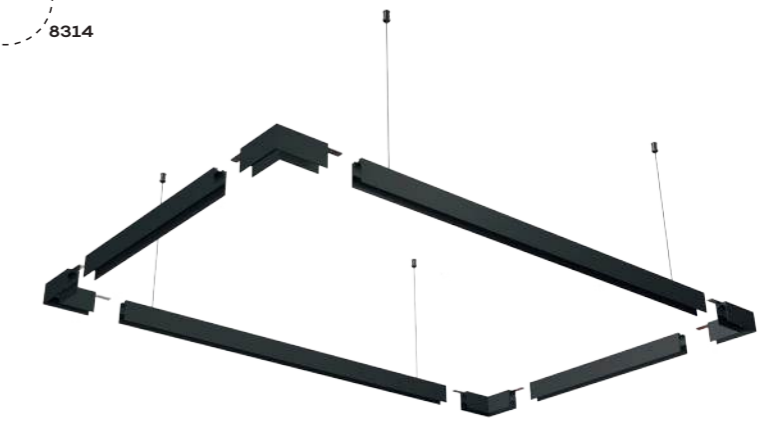
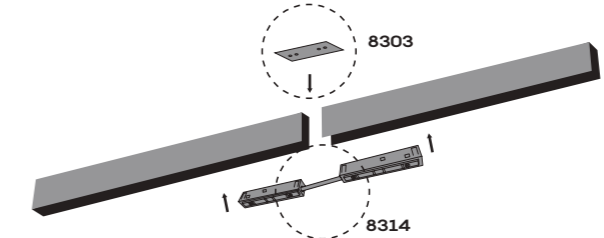
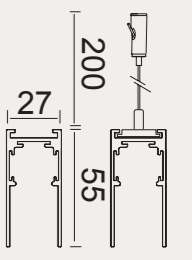
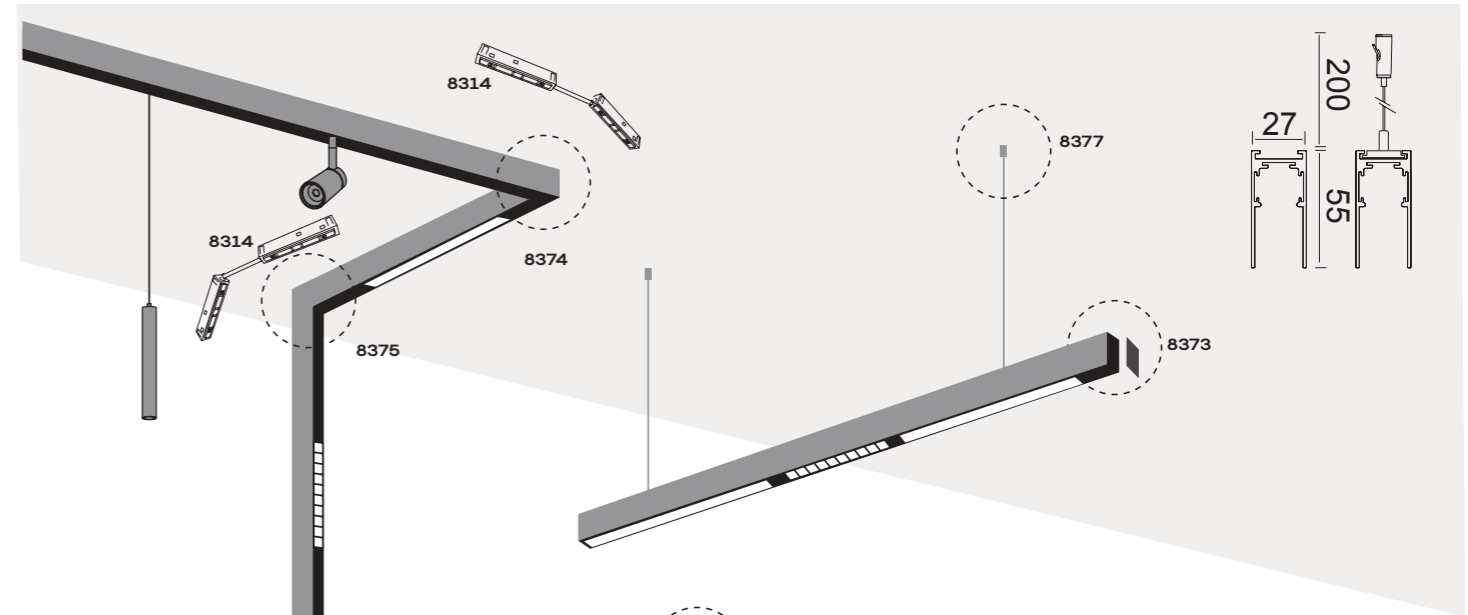

* Tapa incluida-Cover included

MAGNETO 48V

Indoor

RECESSED TRACK

8307 Track length 1000 mm

8308 Track length 2000 mm

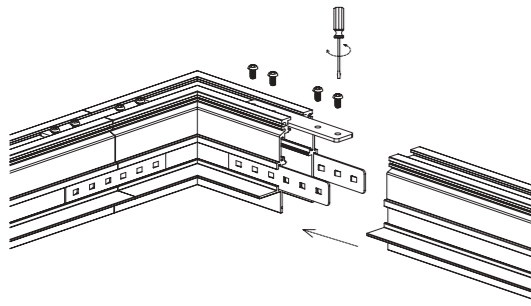

TRACK ACCESSORIES

8309 L-joint 90° plates incl.

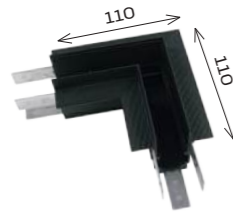

8310 Wall to wall connector (in) plates incl.

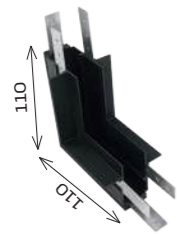

8311 Wall to wall connector (out) plates incl.

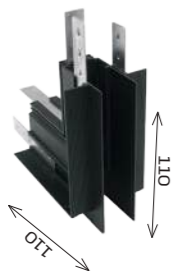

8312 Side track connection plate ×2



8303 Top track connection plate



8314 Live end (connector)



8313 Live end (feeder)



■ Brown +48V

■ Blue -48V

8373 Set 2 end caps

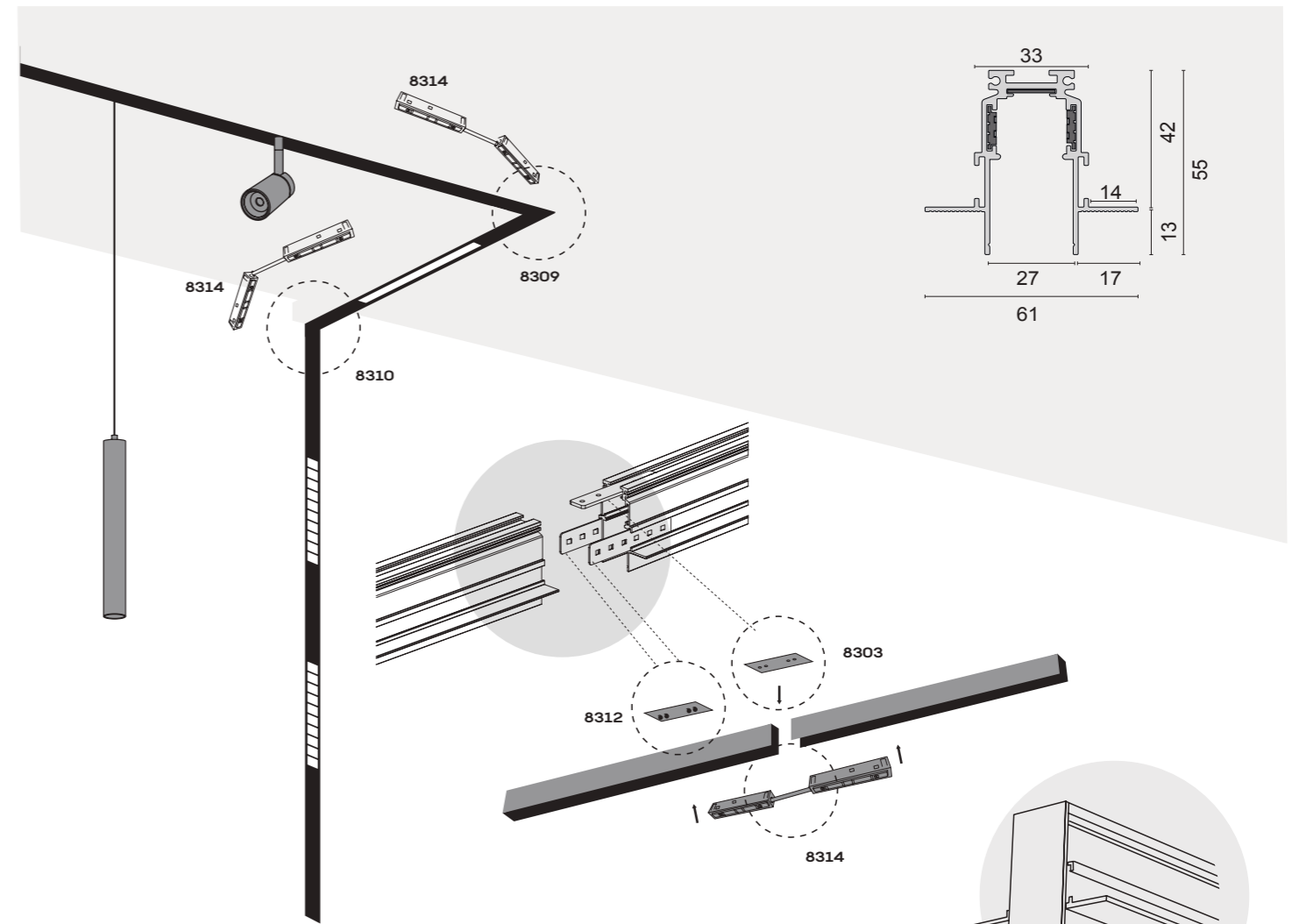

* Tapa incluída-Cover included

Alimentadores ocultos-Driver hidden

Indoor

Tension constante 48v
48v Constant voltage

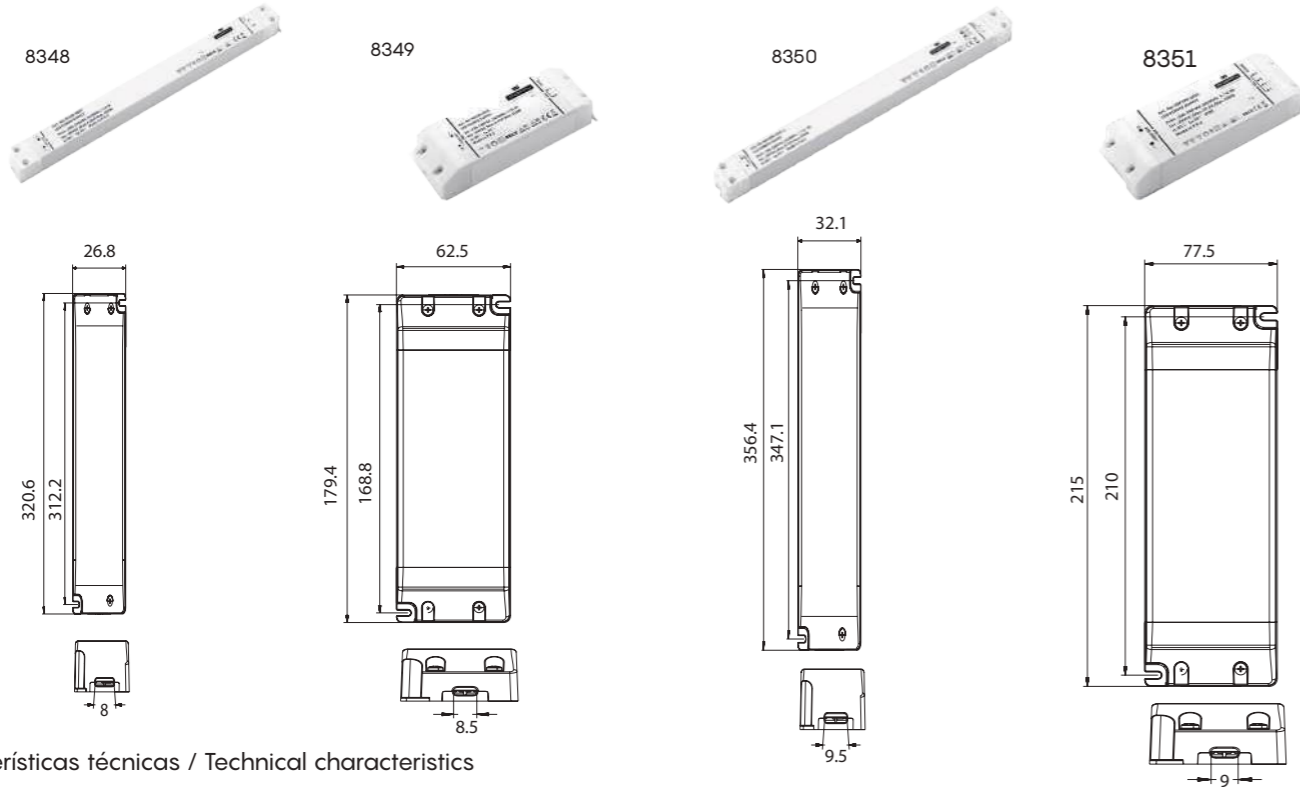

Características técnicas / Technical characteristics

Ref.	Art.-No	Tensión nominal de entrada Nominal input voltage	Rango de potencia en módulo Output power range	Tensión de salida DC Output voltage DC	Corriente de salida máxima Maximum output current	Factor de potencia Power factor	Frecuencia Frequency	Temp. máx. envolvente Max temp.at tc point	Temp. funcionamiento Operating temp.	Protección Protection
		Vac	W	Vdc	A	λ	Hz	tc (°C)	ta (°C)	IP
8348	SL100-48VF-1	200-240V	0-100	48	2.05	$\geq 0,95$	50/60	90°	-20...+45°	20
8349	SS150-48VL	200-240V	0-150	48	3.12	$\geq 0,95$	50/60	90°	-20...+45°	20
8350	SL240-48VF	220-240V	0-240	48	5.00	$\geq 0,95$	50/60	90°	-20...+45°	20
8351	SNP320-48VL-1	220-240V	0-320	48	6.67	$\geq 0,95$	50/60	90°	-20...+45°	20

REGULABLE/DIMMABLE



NO REGULABLE/NO DIMMABLE



Alimentador en carril-Driver in track

Tension constante 48v
48v Constant voltage



NO DIMMABLES



Características técnicas / Technical characteristics

NO DIMMABLES

Ref.	Art.-No	Tensión nominal de entrada Nominal input voltage	Rango de potencia en módulo Output power range	Tensión de salida DC Output voltage DC	Corriente de salida máxima Maximum output current	Factor de potencia Power factor	Frecuencia Frequency	Temp. máx. envolvente Max temp.at tc point	Temp. funcionamiento Operating temp.	Protección Protection
		Vac	W	Vdc	A	λ	Hz	tc (°C)	ta (°C)	IP
8330		220-240V	0-100	48	1.25	$\geq 0,95$	50/60	85°	-20...+45°	20
8331		200-240V	0-200	48	2.5	$\geq 0,7$	50/60	80°	-20...+50°	20



SISTEMA REGULACIÓN TENSIÓN CONSTANTE TRIAC 48v
48v CONSTANT VOLTAGE DIMMING TRIAC SYSTEM

V1-S

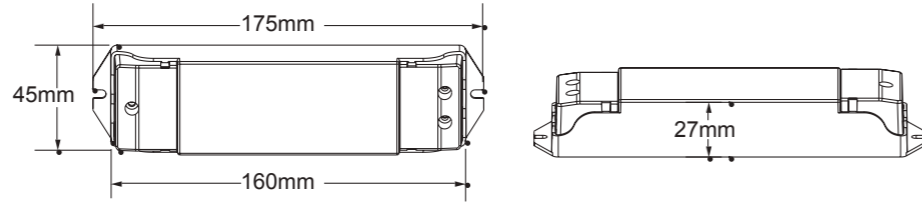

Permite la regulación de tiras led monocolor (12/24/36V) y carriles magnéticos de 48V.

Puede regular con mecanismos TRIAC y mecanismos pulsadores standard (PUSH).

Puedes conectar varios al mismo mecanismo PUSH; puedes conectar un PUSH y un TRIAC al mismo tiempo.

máx.entrada: 15A / máx.salida: 1 canal de 15A.

Protección contra sobrecargas eléctricas, cortocircuitos y sobrecalentamiento.

Señal entrada regulador AC 40-220v.

Allows to control single color LED strips (12/24/36 V) and 48V magnetic tracks.

Suitable for TRIAC controllers and standard PUSH switches.

You may connect several to the same PUSH switch; also you may connect PUSH switch and TRIAC dimmer at the same time.

max.Input: 15A / max.Output : 1 channel -15A .

Protection against over current, short circuit & over temperature

Input dimmig signal AC 40-220v.

Esquema de conexión / Connection diagram

Ref.	Input-output Voltage	Tipo de regulación Control signal	Intensidad máx. de salida Max output current	Potencia máx. de salida Max output power	Tipo tira Led/magnetic Led strip type/magnetic	Control a través de Control made by
	V	mA	A	12V 24V 36V 48V	Monocolor	Pulsador standard y/o triac
8347	12-48VDC	PWM PUSH TRIAC	1CH,15A	180W 360W 540W 720W	MONOC. DIM (1CH)	Standard push switch and/or triac

Estructuras e Instalaciones Mecánicas / Mechanical Structures and Installations

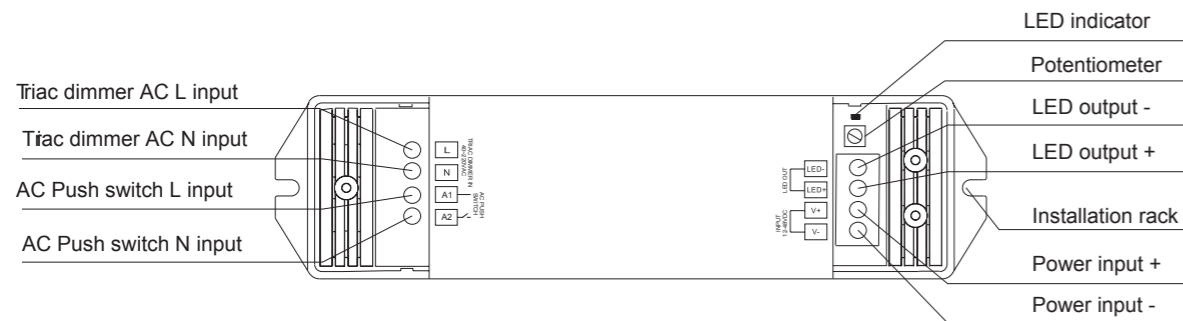

Conecte el atenuador Triac con un solo cable, sin cable neutro.
Connect single wire Triac dimmer, without neutral wire.

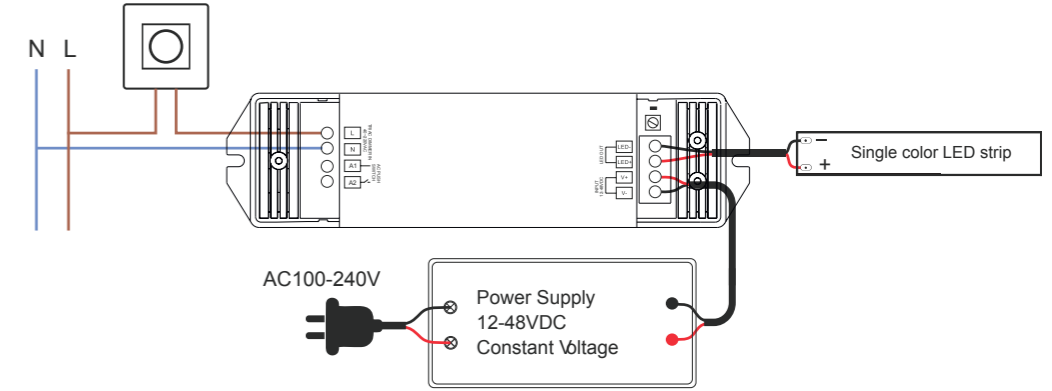

Conecte el atenuador Triac con entrada de cable neutro
Connect Triac dimmer with neutral wire input

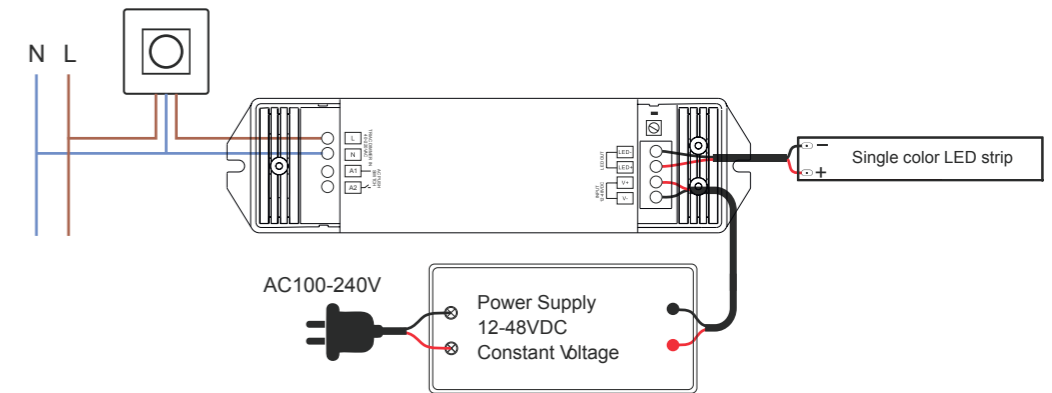

Conectar con el interruptor Push de CA
Connect with AC push switch

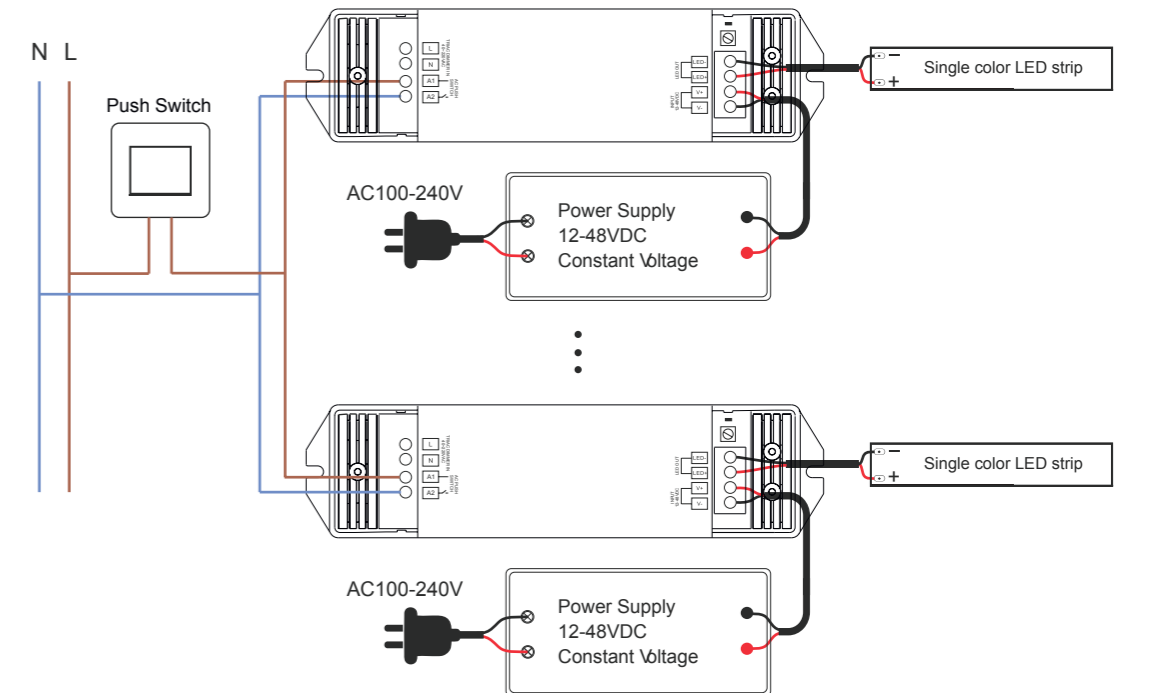

Focos carril trifásico

Three-phase rail
spotlights

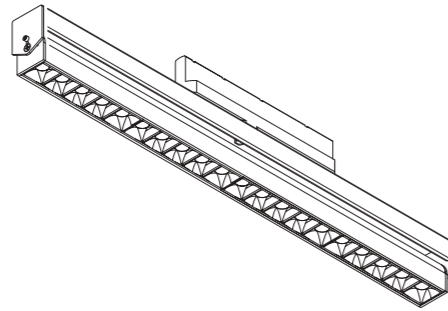
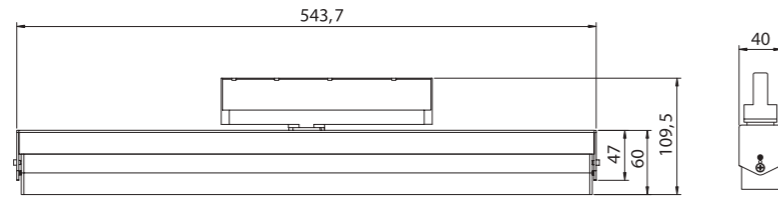

UGR<19 CRI≥90



REFERENCE	K	LED WATT	LUMENS	FINISH
8359	3000K	30W	2350lm	Blanco-White
8360	3000K	30W	2350lm	Negro-Black
8361	4000K	30W	2400lm	Blanco-White
8362	4000K	30W	2400lm	Negro-Black
220-240V - 50/60Hz CRI≥90				Aluminio-Aluminium

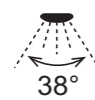

UGR<19





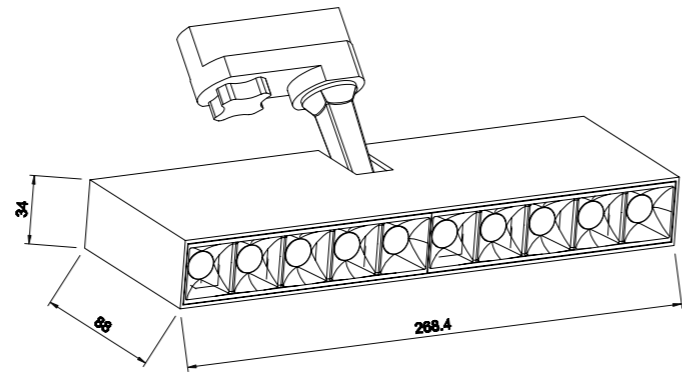

UGR<19

CRI≥90

REFERENCE	K	LED WATT	LUMENS	FINISH
8363	3000K	30W	2350lm	Blanco-White
8364	3000K	30W	2350lm	Negro-Black
8365	4000K	30W	2400lm	Blanco-White
8366	4000K	30W	2400lm	Negro-Black
220-240V~ 50/60Hz CRI≥90				Aluminio-Aluminium



UGR<19





REFERENCE	K	LED WATT	LUMENS	FINISH
7315	3000K	35W	3500lm	Blanco-White
7317	3000K	35W	3500lm	Negro-Black
7316	4000K	35W	3850lm	Blanco-White
7318	4000K	35W	3850lm	Negro-Black
220-240V~ 50/60Hz CRI≥90				Aluminio-Aluminium

LENTES-LENS

ref 7319 _13°	NOT INCLUDED
ref 7320 _24°	NOT INCLUDED
ref 7321 _38°	Included*

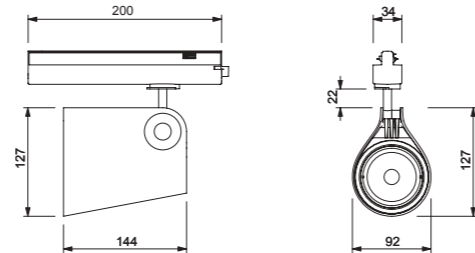

PANAL DE ABEJA-HONEYCOMB

ref 7322	NOT INCLUDED
----------	--------------

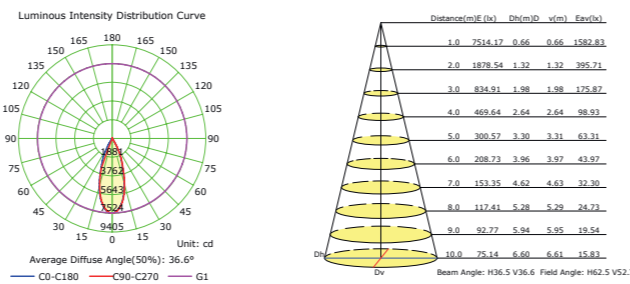
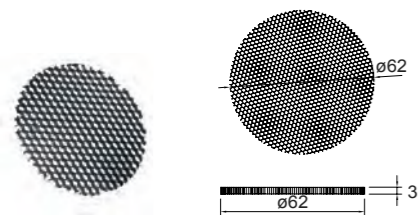

TIR LENS



Registered N° 007663331-0017.



REFERENCE	BULB (No incl)	FINISH
7788	1L x GU10	Blanco mate-Matt white
7789	1L x GU10	Negro mate-Matt black
	máx. 12W LED (No incl)	100-240V ~ 50/60Hz Metal-Metal

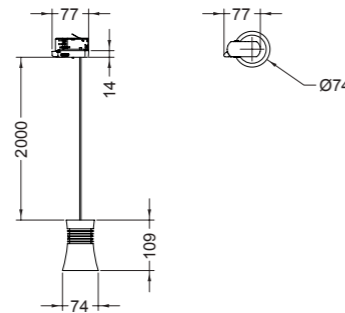

7787
pág. 134



PAGODA

by David Villalba

Colgante carril trifásico-Triphasic rail spot

Indoor

UGR<16 CRI≥90



REFERENCE	K	LED WATT	LUMENS	FINISH
7780	3000K	12,5W	950lm	Blanco-White
7782	3000K	12,5W	950lm	Negro-Black
7781	4000K	12,5W	1050lm	Blanco-White
7783	4000K	12,5W	1050lm	Negro-Black
220-240V~ 50/60Hz CRI≥90				Aluminio-Aluminium

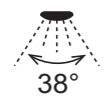

TIR LENS

UGR<16



LED life / LED vida
30.000 h



ON / OFF
30.000



5 años de garantía
WARRANTY
GARANTIA
LED



LED INCLUDED



IP20



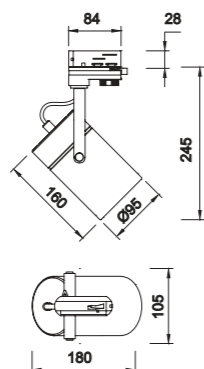

REFERENCE	BULB (No incl)	FINISH
6044	1L x E27	Blanco-White
6045	1L x E27	Negro-Black
máx. 20W LED (No incl)		100-240V~50/60Hz Metal-Metal



5626 pág. 190 6015 pág. 188 5622 pág. 150

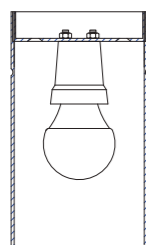

Sferic Bulb: Ø45*78

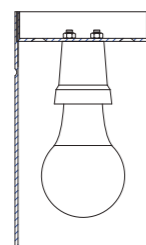

MiniStandard Bulb: Ø55*103

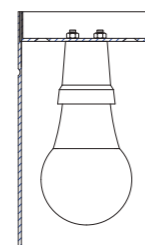

Standard Bulb: Ø60*108

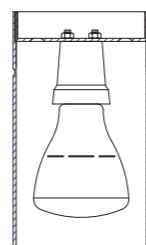

R63 Bulb: Ø63*105

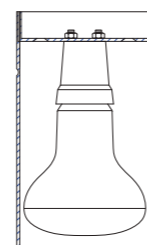

R80 Bulb: Ø80*116



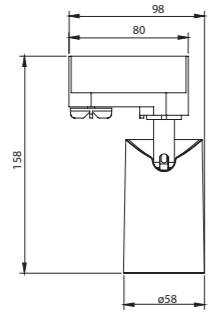

REFERENCE	BULB NOT INCLUDED	FINISH
6717	1L x GU10	Blanco-White
6718	1L x GU10	Negro-Black
máx. 10W LED (No incl) 100-240V~ 50/60Hz Aluminio-Aluminium		



Bombillas recomendadas-Suggested bulbs

K	Wat LED	Reference
3000K	6W	R09196
4000K	6W	R09214
5000K	6W	R09197



7523 pág. 58 8295 pág.284



8297 pág. 120 7961 pág. 90 6281 pág. 180 6283 pág.60 7522 pág. 168 6281 pág. 156



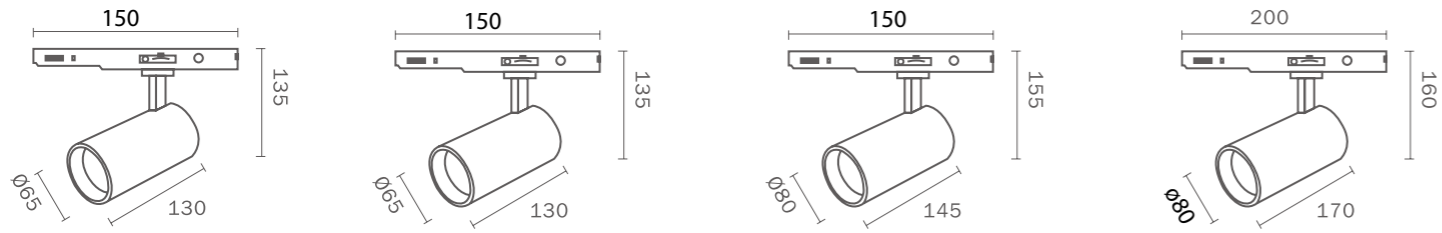

REFERENCE	K	LED WATT	LUMENS	FINISH	OPTICAL Included*	ANGLE
7200	3000K	15W	1500lm	Blanco-White	7218	38°
7204	4000K	15W	1650lm	Blanco-White	7218	38°
7201	3000K	20W	2000lm	Blanco-White	7218	38°
7205	4000K	20W	2200lm	Blanco-White	7218	38°
7202	3000K	30W	3000lm	Blanco-White	7221	38°
7206	4000K	30W	3300lm	Blanco-White	7221	38°
7203	3000K	40W	4000lm	Blanco-White	7224	38°
7207	4000K	40W	4400lm	Blanco-White	7224	38°
220-240V ~ 50/60Hz CRI: ≥ 90				Aluminio-Aluminium		

* Reflector-Optic

REFERENCE 15/20W	REFERENCE 30/40W	REFERENCE 40W	BEAM ANGLE	INCLUDED
7216	7219	7222	15°	not included
7217	7220	7223	24°	not included
*7218	*7221	*7224	38°	Included*



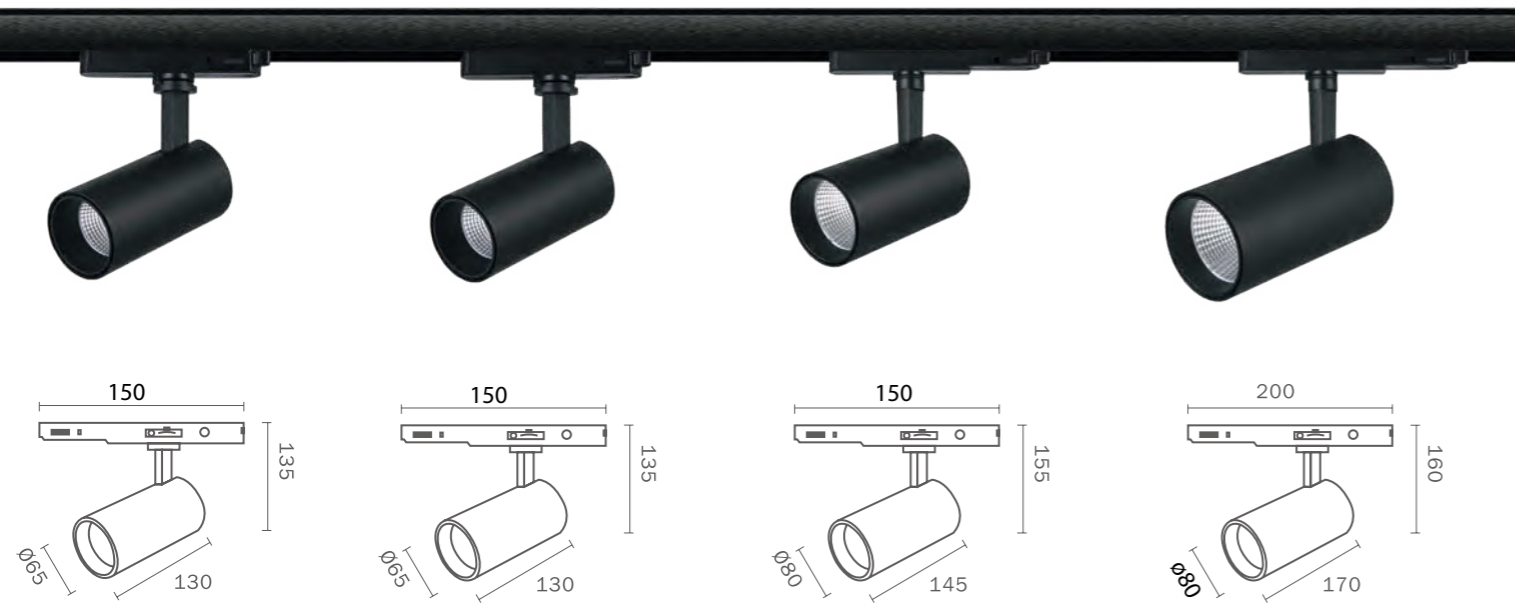

REFERENCE	K	LED WATT	LUMENS	FINISH	OPTICAL Included*	ANGLE
7208	3000K	15W	1500lm	Negro-Black	7218	38°
7212	4000K	15W	1650lm	Negro-Black	7218	38°
7209	3000K	20W	2000lm	Negro-Black	7218	38°
7213	4000K	20W	2200lm	Negro-Black	7218	38°
7210	3000K	30W	3000lm	Negro-Black	7221	38°
7214	4000K	30W	3300lm	Negro-Black	7221	38°
7211	3000K	40W	4000lm	Negro-Black	7224	38°
7215	4000K	40W	4400lm	Negro-Black	7224	38°

220-240V ~ 50/60Hz CRI: ≥ 90 Aluminio-Aluminium

* Reflector-Optic

REFERENCE 15/20W	REFERENCE 30/40W	REFERENCE 40W	BEAM ANGLE	INCLUDED
7216	7219	7222	15°	not included
7217	7220	7223	24°	not included
*7218	*7221	*7224	38°	Included*



LED 15W 3000K 38°

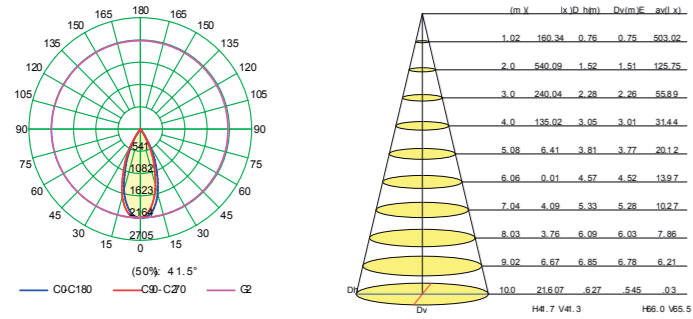

LED 15W 4000K 38°

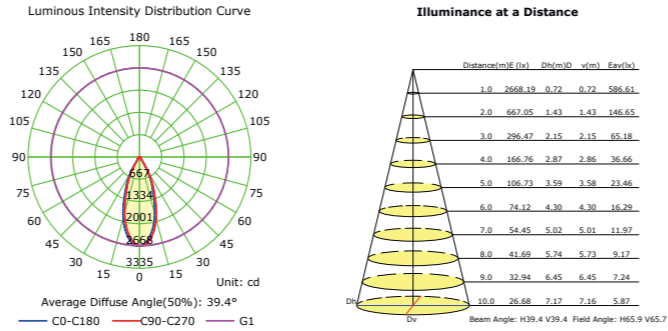

LED 20W 3000K 38°

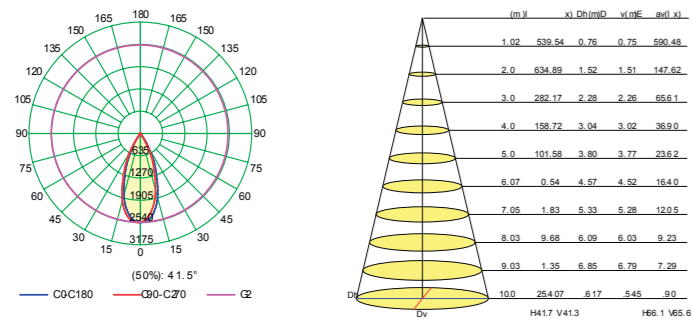

LED 20W 4000K 38°

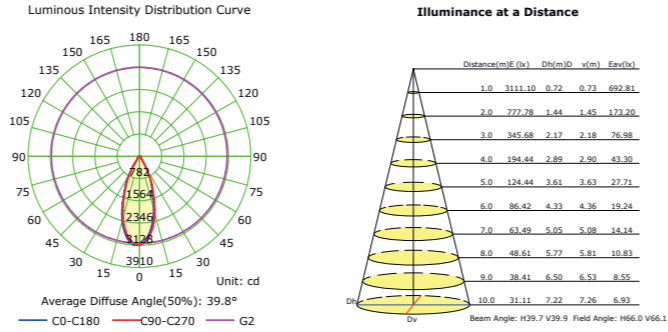

LED 30W 3000K 38°

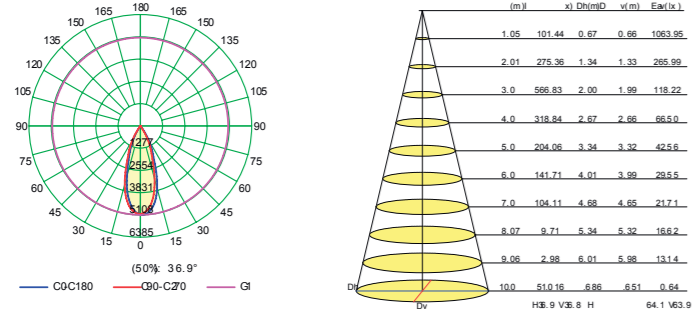

LED 30W 4000K 38°

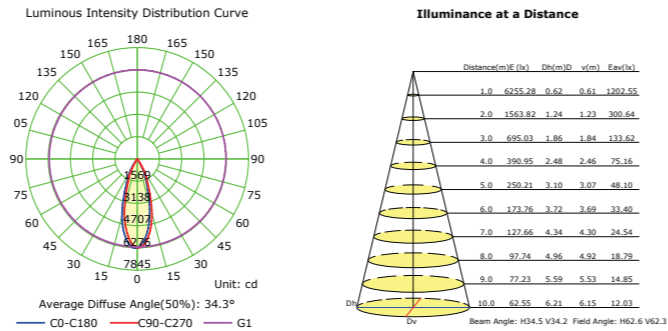

LED 40W 3000K 38°

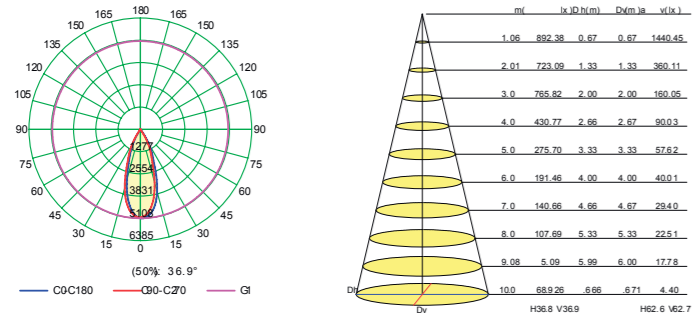

LED 40W 4000K 38°

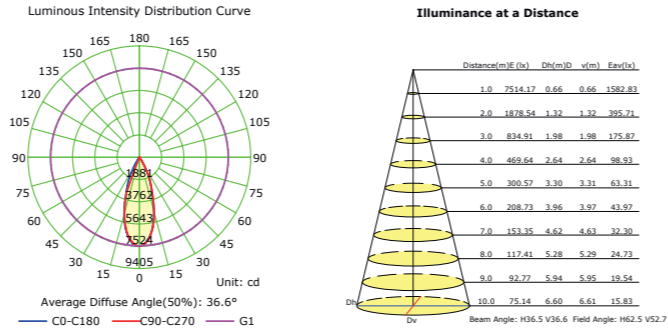

CARRILES trifásicos



CARRIL DE SUPERFICIE-SURFACE MOUNTED TRACK

XTS 41002 Negro-Black

XTS 41003 Blanco-White

Track length 1000 mm

XTS 42002 Negro-Black

XTS 42003 Blanco-White

Track length 2000 mm

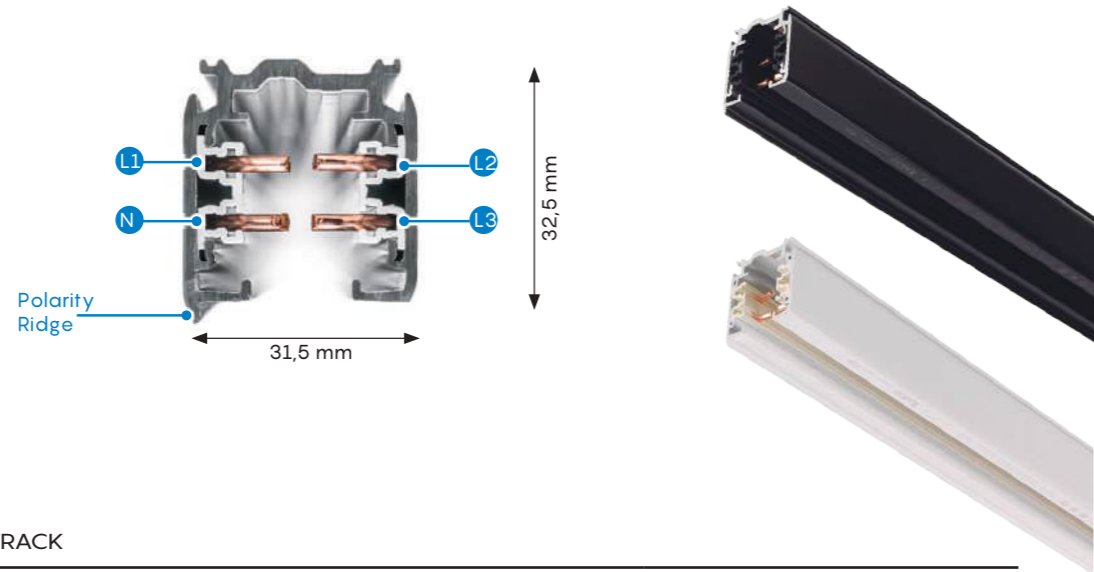

CARRIL DE EMPOTRAR-RECESSED TRACK

XTSF41002 Negro-Black

XTSF41003 Blanco-White

Track length 1000 mm

XTSF42002 Negro-Black

XTSF 42003 Blanco-White

Track length 2000 mm

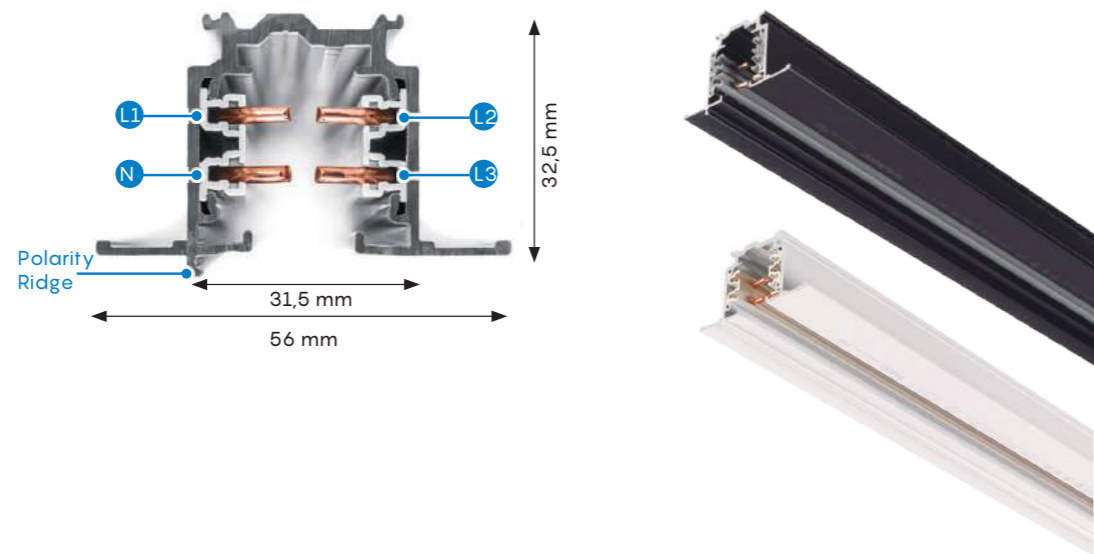

Power Conductor Cross-Section: 4,0mm²

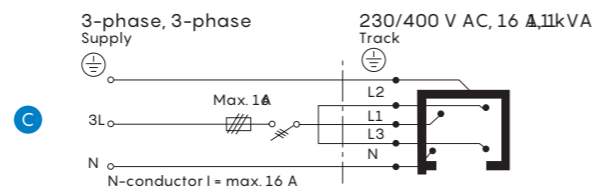
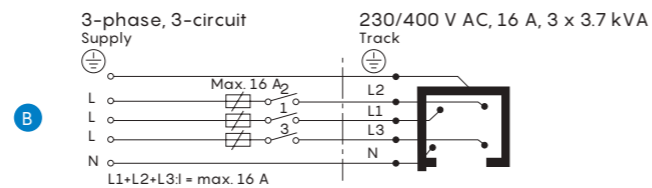
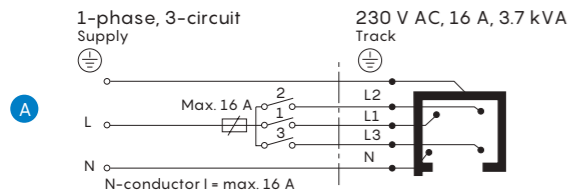

FINAL ALIMENTADOR POLARIDAD DERECHA-END FEED POLARITY RIGHT

XTS 112 Negro-Black

XTS 113 Blanco-White

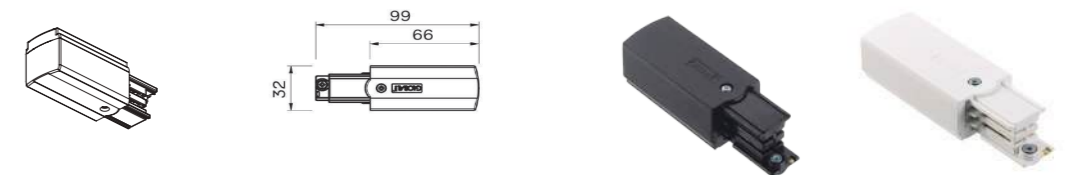

FINAL ALIMENTADOR POLARIDAD IZQUIERDA-END FEED POLARITY LEFT

XTS 122 Negro-Black

XTS 123 Blanco-White

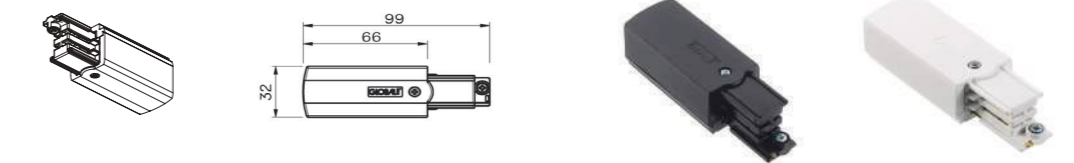

TAPA FINAL-END CAP

XTS 412 Negro-Black

XTS 413 Blanco-White



PLACA PARA CUBRIR EN CARRILES EMPOTRADOS -PLATE TO COVER IN RECESSED TRACKS

XTSF 102 Negro-Black XTS112-XTS122-XTS142

XTSF 103 Blanco-White XTS113-XTS123-XTS143



XTSF 302 Negro-Black

XTS342-XTS352-XTS362-XTS372-XTS382-XTS392-XTS402

XTSF 303 Blanco-White

XTS343-XTS353-XTS363-XTS373-XTS383-XTS393-XTS403



LEVA FIJACIÓN TECHO FUNDICIÓN PARA CARRILES SUPERFICIE-STANDARD CLAMP DIE CAST FOR SURFACE TRACK

SKB 122 Negro-Black

SKB 123 Blanco-White



KIT SUSPENSION CARRIL 1,5 M -SUSPENSION KIT 1,5 M

SPW11SK 215 length 1500 mm Negro-Black

SPW11SK 315 length 1500 mm Blanco-White



CARRILES trifásicos



ALIMENTADOR INTERMEDIO RECTO-MIDDLE FEED STRAIGHT

XTS 142 Negro-Black

XTS 143 Blanco-White



CONECTOR INTERMEDIO RECTO-MIDDLE STRAIGHT CONNECTOR

XTS 212 Negro-Black

XTS 213 Blanco-White



CONECTOR ESQUINA AJUSTABLE-ADJUSTABLE CORNER CONNECTOR

XTS 242 Negro-Black

XTS 243 Blanco-White



CONEXIÓN ALIMENTADOR EN L POLARIDAD INTERNA - L FEED POLARITY INTERNAL

XTS 342 Negro-Black

XTS 343 Blanco-White

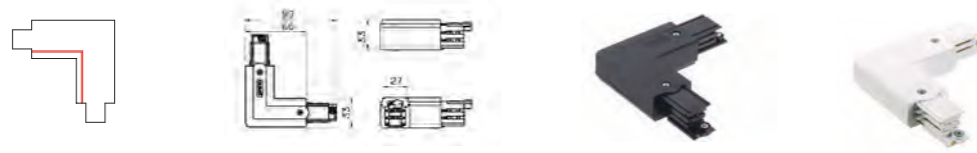

CONEXIÓN ALIMENTADOR EN L POLARIDAD EXTERNA - L FEED POLARITY EXTERNAL

XTS 352 Negro-Black

XTS 353 Blanco-White

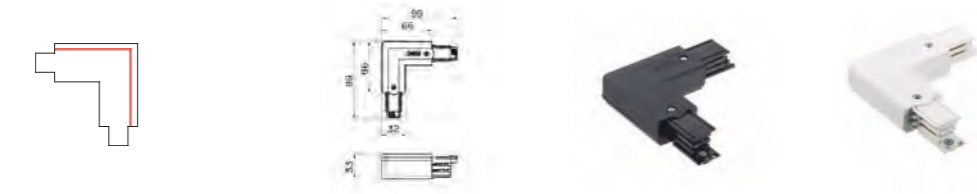

CONEXIÓN ALIMENTADOR EN X - X FEED

XTS 382 Negro-Black

XTS 383 Blanco-White

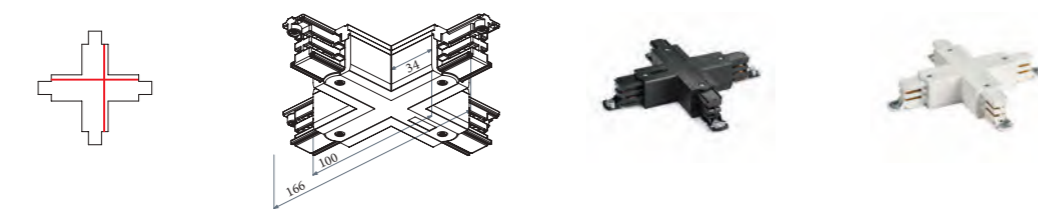

CONEXIÓN ALIMENTADOR EN T- T FEED

XTS 362 Negro-Black

XTS 363 Blanco-White



XTS 372 Negro-Black

XTS 373 Blanco-White

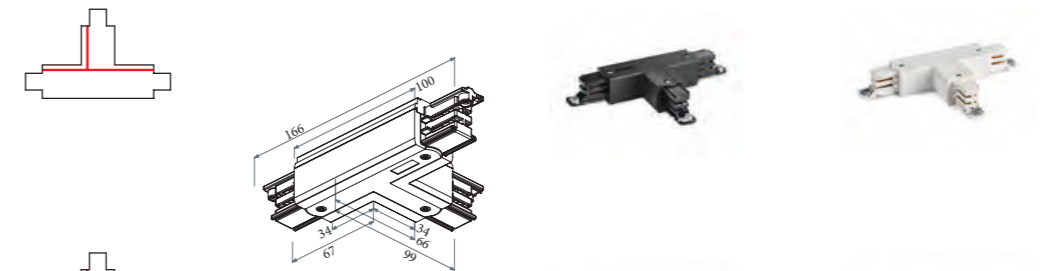

XTS 392 Negro-Black

XTS 393 Blanco-White



XTS 402 Negro-Black

XTS 403 Blanco-White

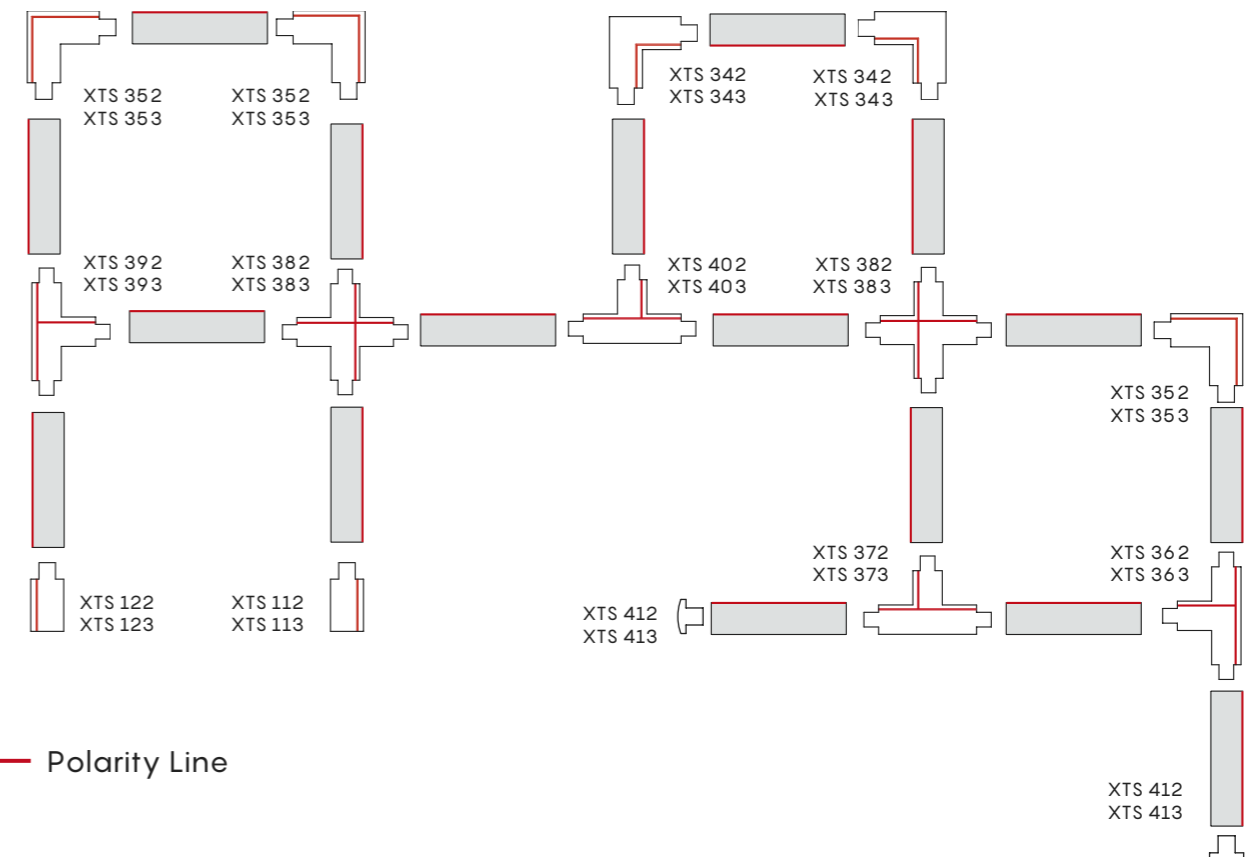

— Polarity Line

CARRILES trifásicos

New

CARRIL DE SUPERFICIE-SURFACE MOUNTED TRACK

8548 Negro-Black

8549 Blanco-White

Track length 1000 mm

8550 Negro-Black

8551 Blanco-White

Track length 2000 mm

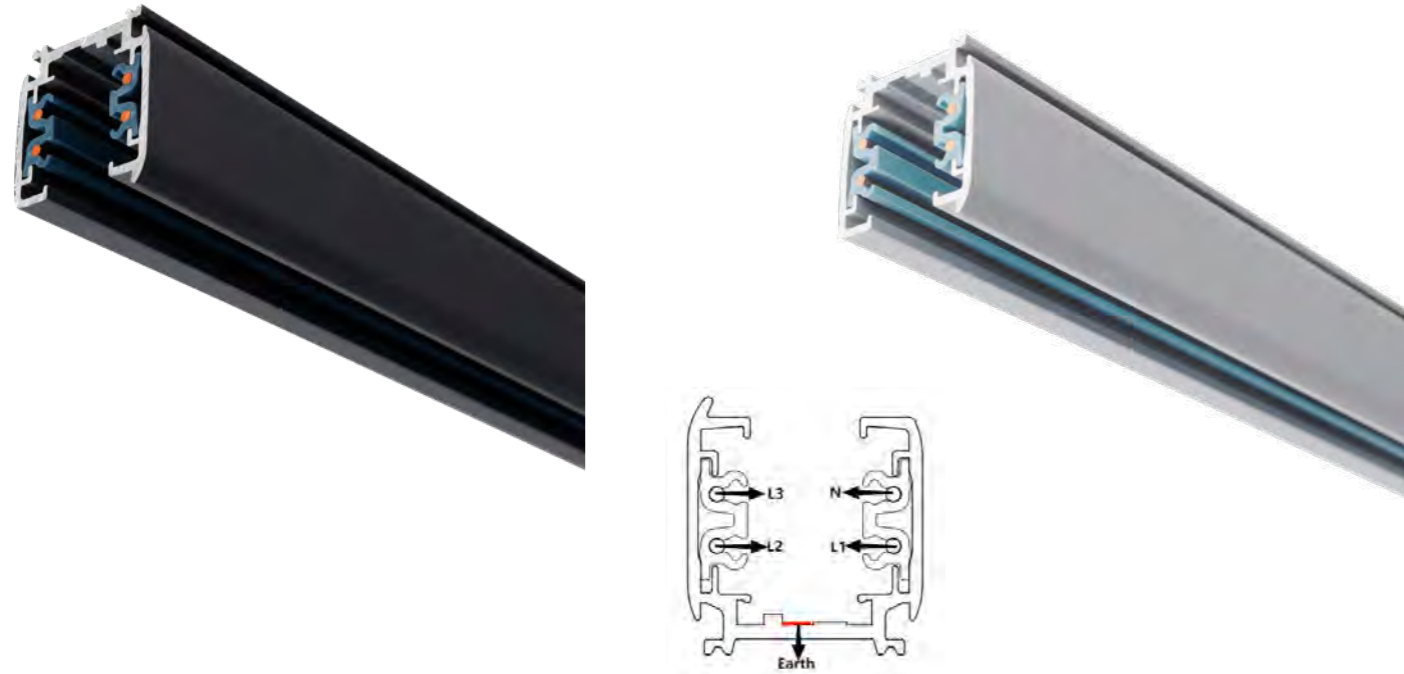

FINAL ALIMENTADOR POLARIDAD DERECHA-END FEED POLARITY RIGHT

8552 Negro-Black

8553 Blanco-White



FINAL ALIMENTADOR POLARIDAD IZQUIERDA-END FEED POLARITY LEFT

8731 Negro-Black

8732 Blanco-White



TAPA FINAL-END CAP

8554 Negro-Black

8555 Blanco-White



LEVA FIJACIÓN TECHO FUNDICIÓN PARA CARRILES SUPERFICIE-STANDARD CLAMP DIE CAST FOR SURFACE TRACK

8562 Negro-Black

8563 Blanco-White

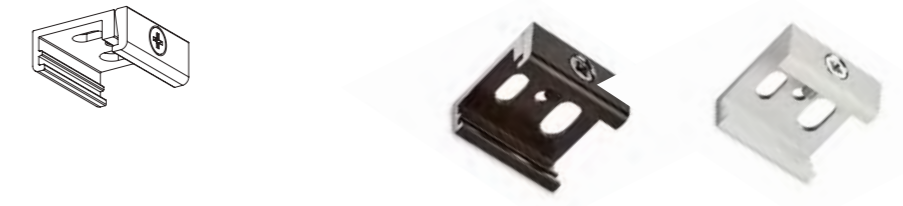

KIT SUSPENSIÓN CARRIL 2M-SUSPENSION KIT 2M

8560 length 2000 mm Negro-Black

8561 length 2000 mm Blanco-White

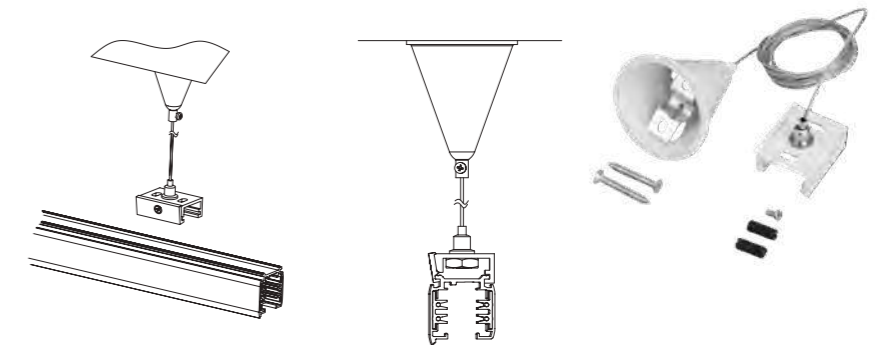

CARRILES trifásicos



ALIMENTADOR INTERMEDIO RECTO-MIDDLE FEED STRAIGHT

- 8558 Negro-Black
- 8559 Blanco-White



CONECTOR INTERMEDIO RECTO-MIDDLE STRAIGHT CONNECTOR

- 8556 Negro-Black
- 8557 Blanco-White



CONEXIÓN ALIMENTADOR EN L POLARIDAD INTERNA - L FEED POLARITY INTERNAL

- 8733 Negro-Black
- 8734 Blanco-White



CONEXIÓN ALIMENTADOR EN L POLARIDAD EXTERNA - L FEED POLARITY EXTERNAL

- 8735 Negro-Black
- 8736 Blanco-White

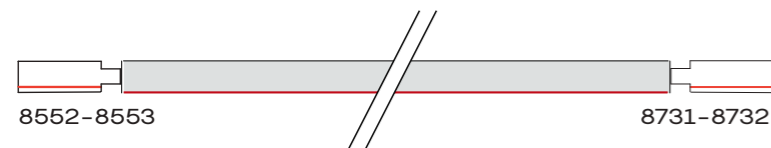

CONEXIÓN ALIMENTADOR EN T- T FEED

- 8737 Negro-Black
- 8738 Blanco-White



- 8739 Negro-Black
- 8740 Blanco-White



- 8741 Negro-Black
- 8742 Blanco-White



- 8743 Negro-Black
- 8744 Blanco-White

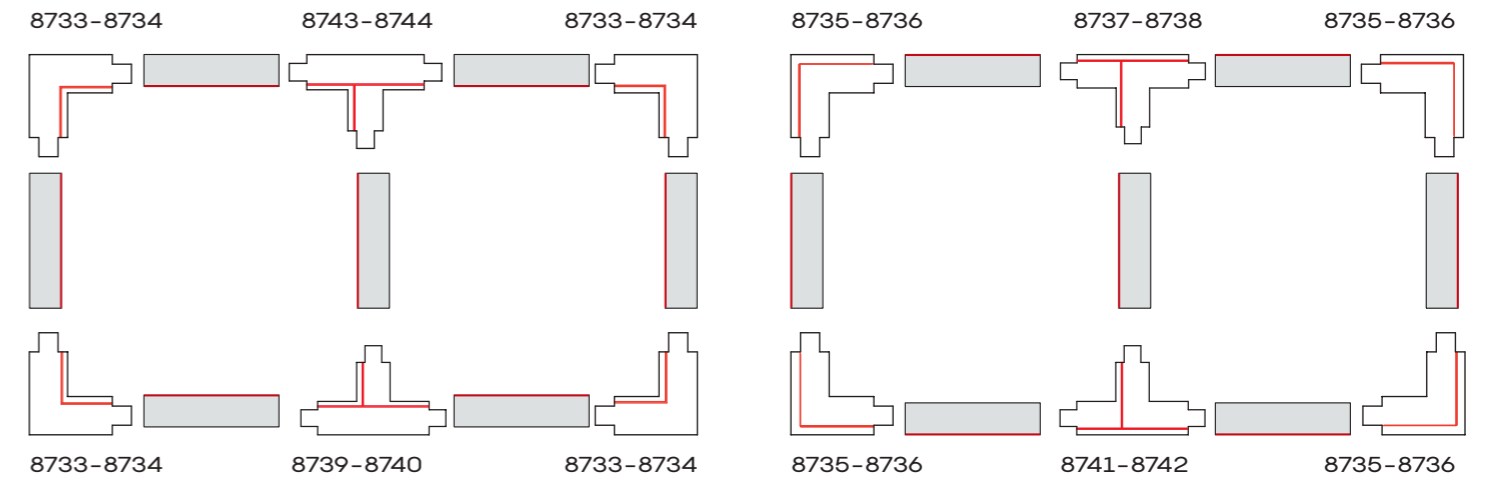

— Polarity line

Empotrables

Recessed

ALGARVE

New

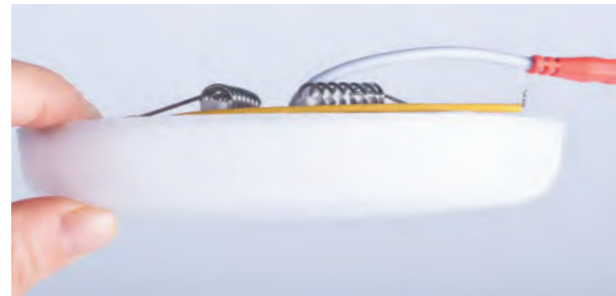
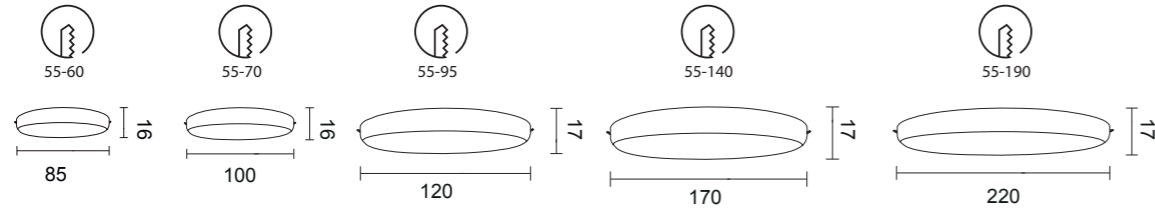

REFERENCE	K	LED WATT	LUMENS	FINISH
8678	3000K	8W	700lm	Blanco-White
8679	3000K	10W	870lm	Blanco-White
8680	3000K	15W	1300lm	Blanco-White
8681	3000K	22W	1900lm	Blanco-White
8682	3000K	32W	2800lm	Blanco-White
8683	4000K	8W	735lm	Blanco-White
8684	4000K	10W	910lm	Blanco-White
8685	4000K	15W	1400lm	Blanco-White
8686	4000K	22W	2040lm	Blanco-White
8687	4000K	32W	3000lm	Blanco-White
220-240V ~ 50/60Hz CRI: ≥ 80				Aluminio-Aluminium



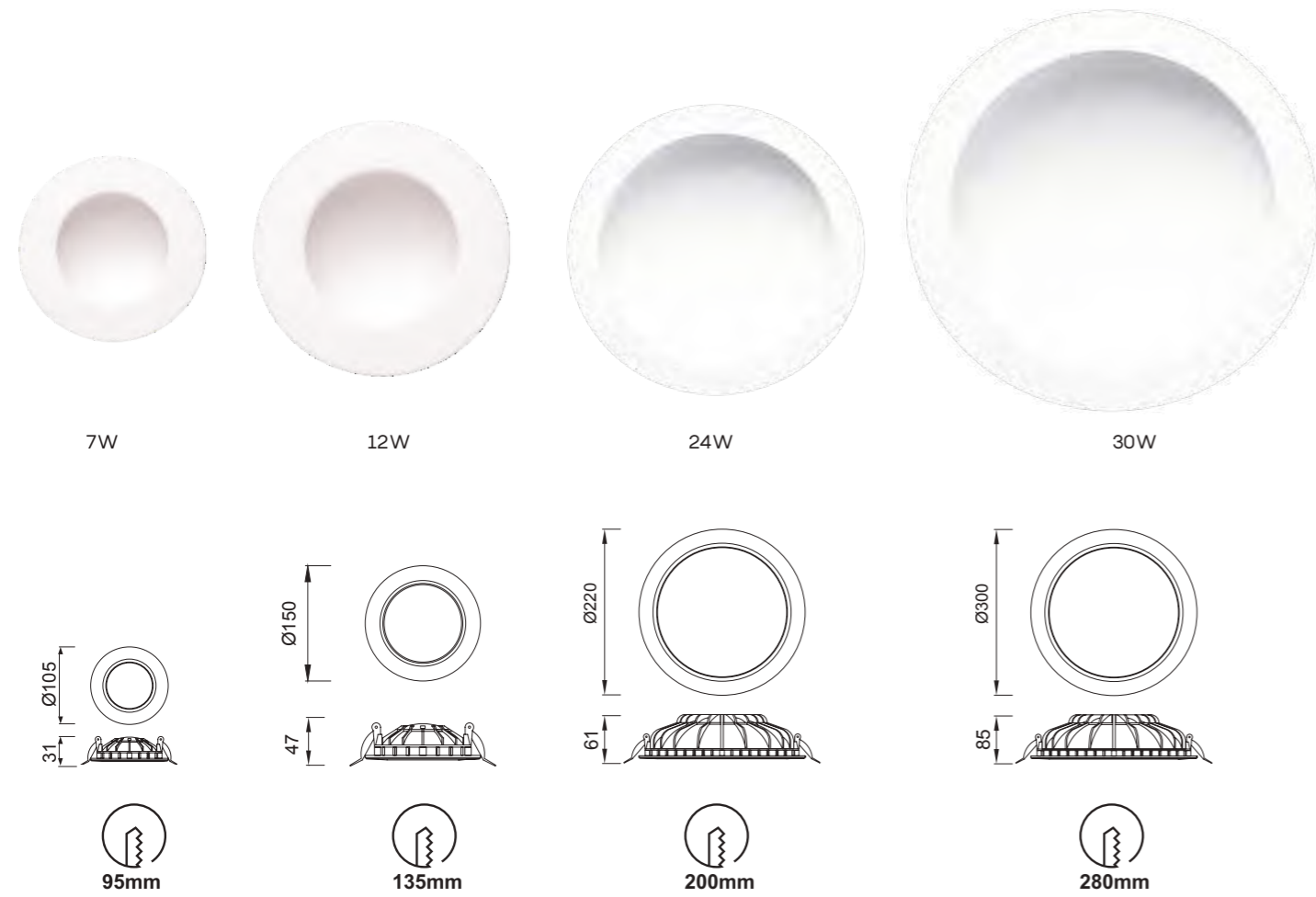

REFERENCE	K	LED WATT	LUMENS	FINISH
C0041	3000K	7W	540lm	Blanco mate-Matt white
C0042	4000K	7W	540lm	Blanco mate-Matt white
C0047	3000K	12W	1080lm	Blanco mate-Matt white
C0048	4000K	12W	1080lm	Blanco mate-Matt white
C0043	3000K	24W	2160lm	Blanco mate-Matt white
C0044	4000K	24W	2160lm	Blanco mate-Matt white
C0049	3000K	30W	2550lm	Blanco mate-Matt white
C0050	4000K	30W	2600lm	Blanco mate-Matt white
220-240V ~ 50/60Hz CRI: ≥ 80				Aluminio-Aluminium



Empotrable-Recessed

Indoor

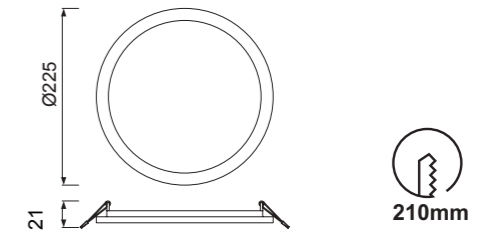
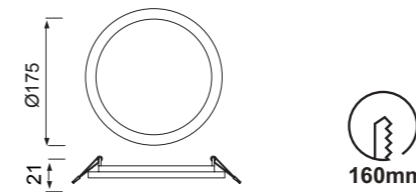
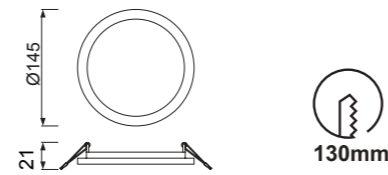
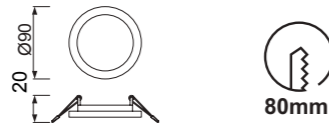

REFERENCE	K	LED WATT	LUMENS	FINISH
C0184	3000K	6W	520lm	Blanco mate-Matt white
C0180	4000K	6W	540lm	Blanco mate-Matt white
C0185	3000K	12W	990lm	Blanco mate-Matt white
C0181	4000K	12W	1080lm	Blanco mate-Matt white
SPCC-PBT/PC		220-240V~ 50/60Hz CRI:≥ 80		Aluminio-Aluminium

REFERENCE	K	LED WATT	LUMENS	FINISH
C0186	3000K	18W	1580lm	Blanco mate-Matt white
C0182	4000K	18W	1620lm	Blanco mate-Matt white
C0187	3000K	24W	2090lm	Blanco mate-Matt white
C0183	4000K	24W	2200lm	Blanco mate-Matt white
SPCC-PBT/PC		220-240V~ 50/60Hz CRI:≥ 80		Aluminio-Aluminium

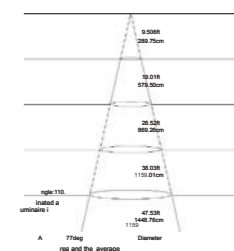
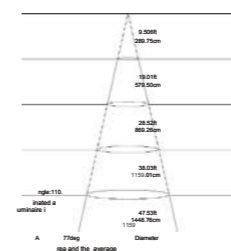
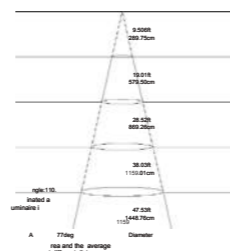
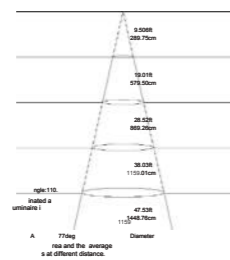
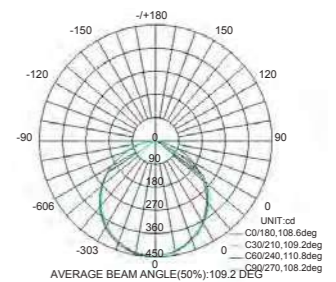
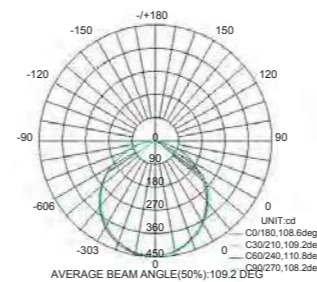
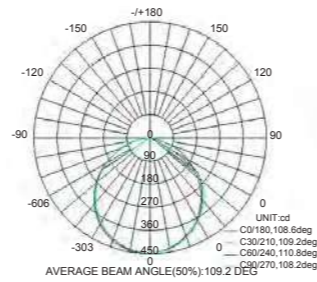
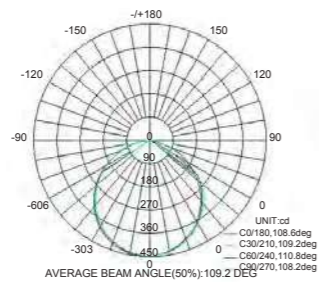



REFERENCE	K	LED WATT	LUMENS	FINISH
C0194	3000K	6W	520lm	Blanco mate-Matt white
C0190	4000K	6W	540lm	Blanco mate-Matt white
C0195	3000K	12W	990lm	Blanco mate-Matt white
C0191	4000K	12W	1080lm	Blanco mate-Matt white
SPCC-PBT/PC		220-240V~ 50/60Hz CRI:≥ 80		Aluminio-Aluminium

REFERENCE	K	LED WATT	LUMENS	FINISH
C0196	3000K	18W	1580lm	Blanco mate-Matt white
C0192	4000K	18W	1620lm	Blanco mate-Matt white
C0197	3000K	24W	2090lm	Blanco mate-Matt white
C0193	4000K	24W	2200lm	Blanco mate-Matt white
SPCC-PBT/PC		220-240V~ 50/60Hz CRI:≥ 80		Aluminio-Aluminium

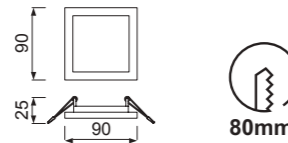

80mm

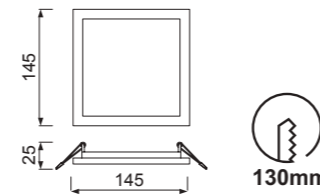

130mm

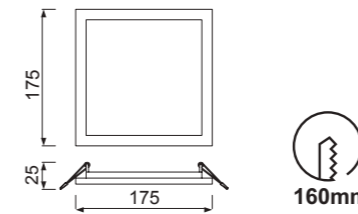

160mm

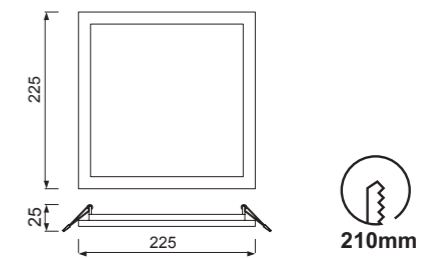

210mm

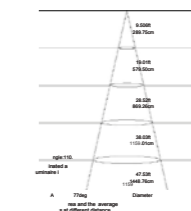
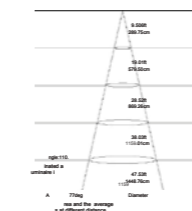
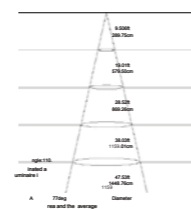
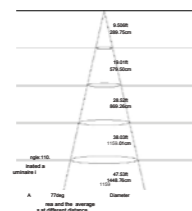
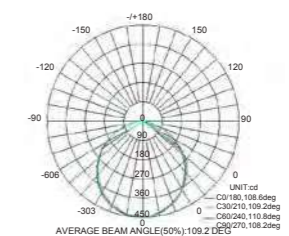
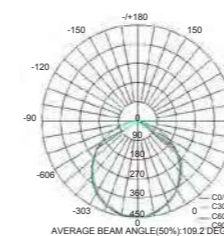
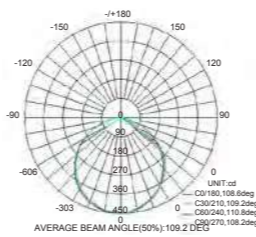
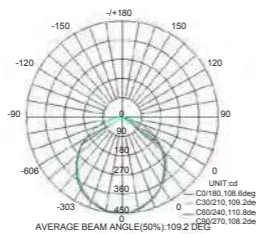

MEDANO

Empotrable-Recessed

Indoor

UGR<19

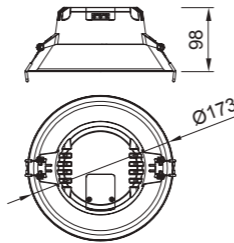
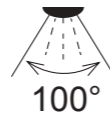
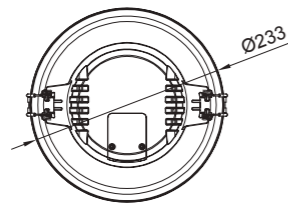
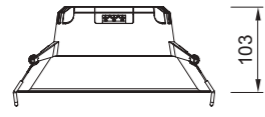
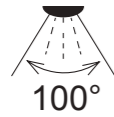

REFERENCE	K	LED WATT	LUMENS	FINISH
6398	3000K	12W	1100lm	Blanco mate-Matt white
6399	4000K	12W	1200lm	Blanco mate-Matt white
6395	3000K	21W	1900lm	Blanco mate-Matt white
SPCC-PBT/PC		220-240V ~ 50/60Hz CRI:≥ 80		Aluminio-Aluminium

GRACIOSA



REFERENCE	K	LED WATT	LUMENS	FINISH	SIZES
6390	3000K	24,5W	1900lm	Blanco mate-Matt white	Ø235
				220-240V ~ 50/60Hz CRI:≥ 80	Aluminio-Aluminium

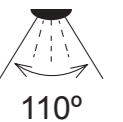
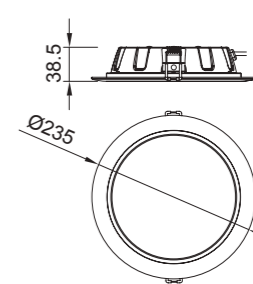
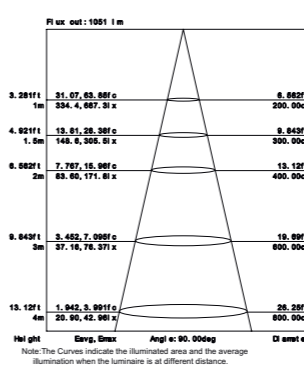
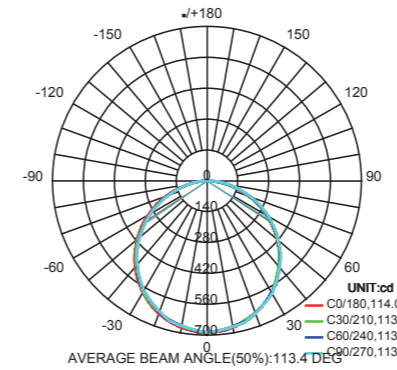
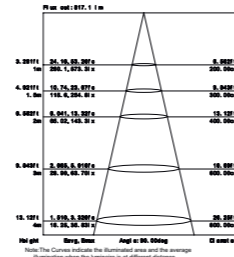
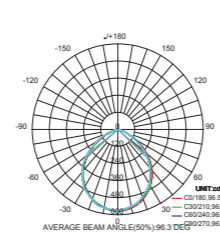
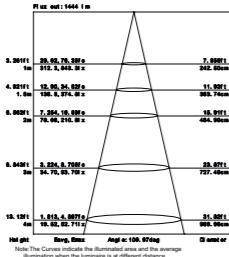
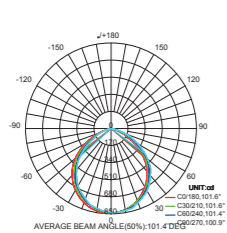

TRIMASI 5W
New

Empotrable-Recessed

Indoor

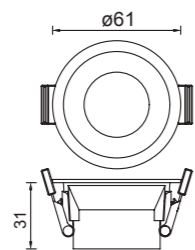

Base empotrar-Recessed base

REFERENCE	FINISH
8447	Blanco mate-Matt white
8448	Negro mate-Matt black

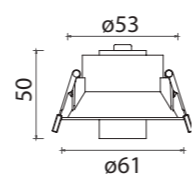
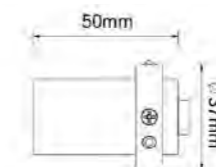

REFERENCE	K	LED WATT	LUMENS	FINISH
8449	3000K	5W	400lm	Oro-Gold
8450	3000K	5W	400lm	Blanco-White
8451	3000K	5W	400lm	Negro-Black
220-240V~50/60Hz CRI≥ 90				Aluminio-Aluminium



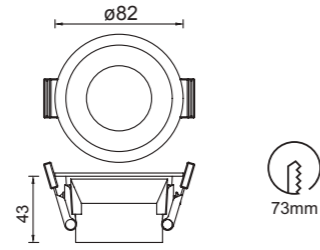

Base empotrar-Recessed base

REFERENCE	FINISH
8452	Blanco mate-Matt white
8453	Negro mate-Matt black

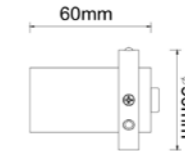

REFERENCE	K	LED WATT	LUMENS	FINISH
8454	3000K	7W	560lm	Oro-Gold
8455	3000K	7W	560lm	Blanco-White
8456	3000K	7W	560lm	Negro-Black
				Aluminio-Aluminium

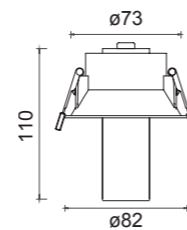
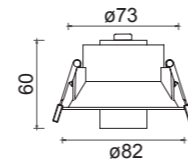

REFERENCE	K	LED WATT	LUMENS	FINISH
8457	3000K	7W	560lm	Oro-Gold
8458	3000K	7W	560lm	Blanco-White
8459	3000K	7W	560lm	Negro-Black
				Aluminio-Aluminium



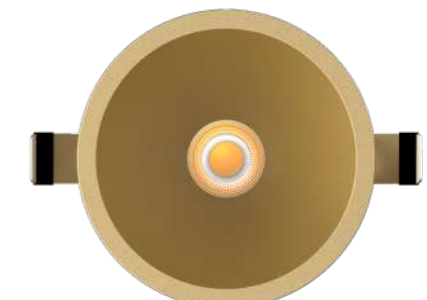

SUNSET

New

Empotrable-Recessed

Indoor

CONFIGURADOR CONFIGURATOR

	1 FRAME			2 HEAT SINKER TEMP		3 DRIVER		
	SIZE	REFERENCE	FINISH	MEASURES	REFERENCE	HEAT SINK TEMP & WATTS	REFERENCE	
55	S	8768	Blanco-White	Ø65*H74	8771	6 W - 2700 K 510 lm	8774	ON/OFF
		8769	Negro-Black		8772	6 W - 3000 K 525 lm	8775	CUT PHASE
		8770	Oro-Gold		8773	6 W - 4000 K 560 lm	8776	DALI/PUSH
75	M	8777	Blanco-White	Ø85*H87	8780	10 W - 2700 K 765lm	8783	ON/OFF
		8778	Negro-Black		8781	10 W - 3000 K 800lm	8784	cut phase
		8779	Oro-Gold		8782	10 W - 4000 K 860lm	8785	DALI/PUSH
95	L	8786	Blanco-White	Ø108*H98	8789	15 W - 2700 K 980lm	8792	ON/OFF
		8787	Negro-Black		8790	15 W - 3000 K 1070lm	8793	CUT PHASE
		8788	Oro-Gold		8791	15 W - 4000 K 1125lm	8794	DALI/PUSH
150	XL	8795	Blanco-White	Ø165*H138	8798	20W - 2700 K 1660lm	8801	ON/OFF
		8796	Negro-Black		8799	20W - 3000 K 1770lm	8802	CUT PHASE
		8797	Oro-Gold		8800	20W - 4000 K 1950lm	8803	DALI/PUSH
150	XL	8795	Blanco-White	Ø165*H138	8798	30 W - 2700 K 2350lm	8804	ON/OFF
		8796	Negro-Black		8799	30 W - 3000 K 2490lm	8805	CUT PHASE
		8797	Oro-Gold		8800	30 W - 4000 K 2690lm	8806	DALI/PUSH
200	XXL	8807	Blanco-White	Ø215*H152	8810	30W - 2700K 2330lm	8804	ON/OFF
		8808	Negro-Black		8811	30W - 3000K 2495lm	8805	CUT PHASE
		8809	Oro-Gold		8812	30W - 4000K 2665lm	8806	DALI/PUSH
200	XXL	8807	Blanco-White	Ø215*H152	8810	40 W - 2700K 3045lm	8813	ON/OFF
		8808	Negro-Black		8811	40 W - 3000K 3215lm	8814	CUT PHASE
		8809	Oro-Gold		8812	40 W - 4000K 3480lm	8815	DALI/PUSH

Aluminio-Aluminium 220-240V~50/60Hz CRI≥ 90

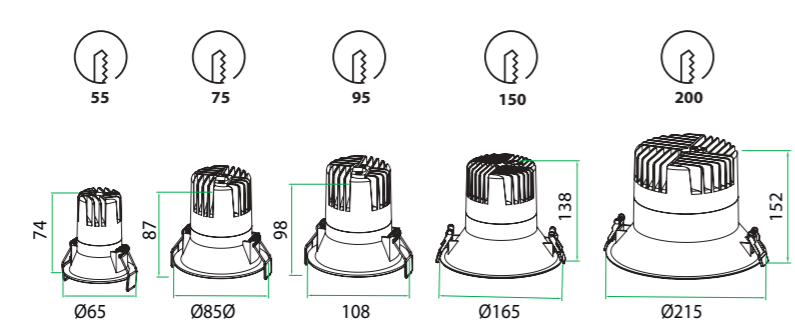
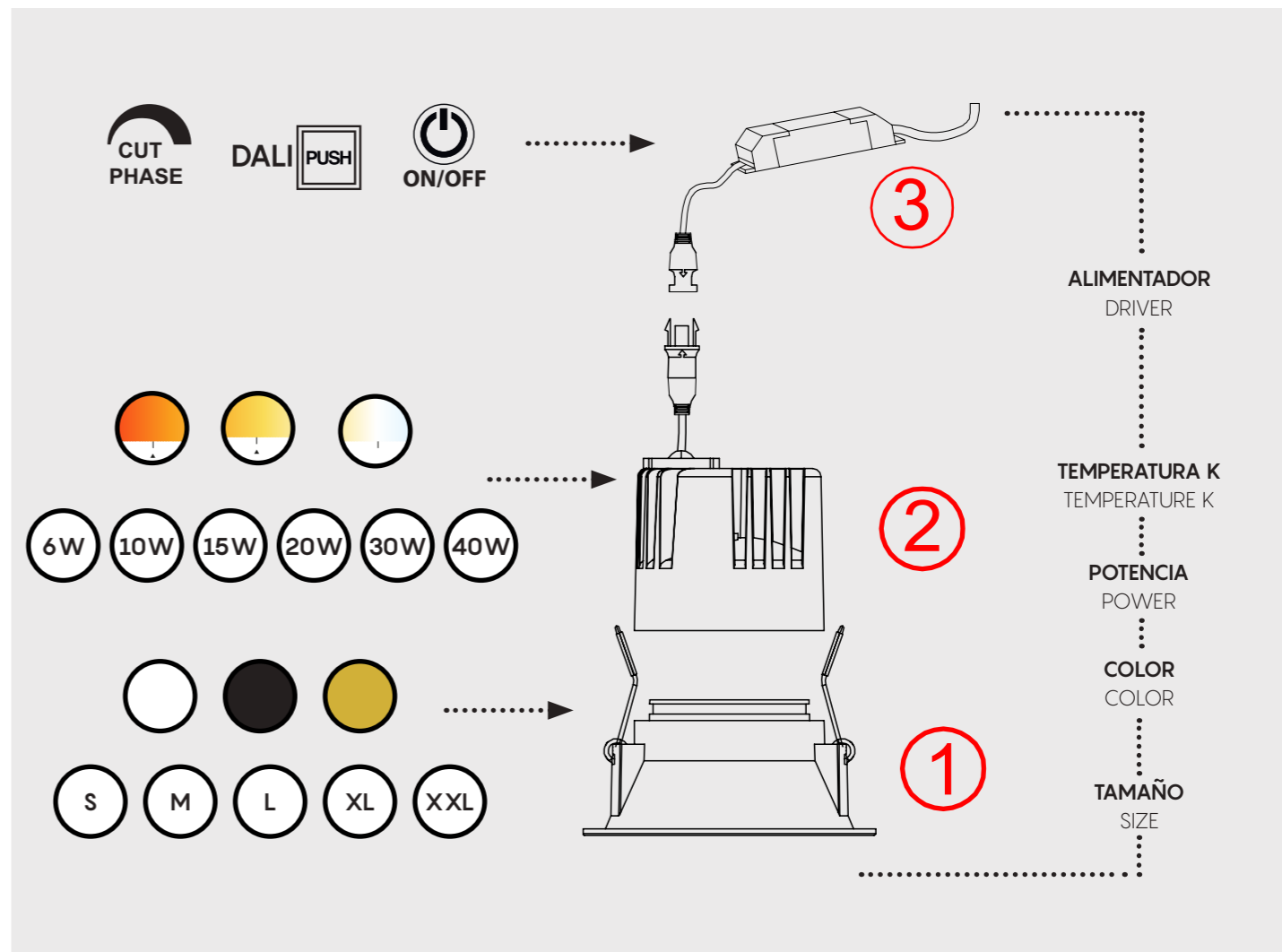

PANAMA
New

Empotrable-Recessed

Indoor

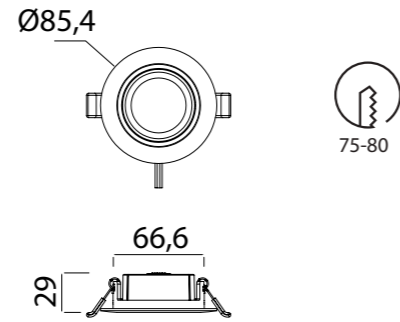
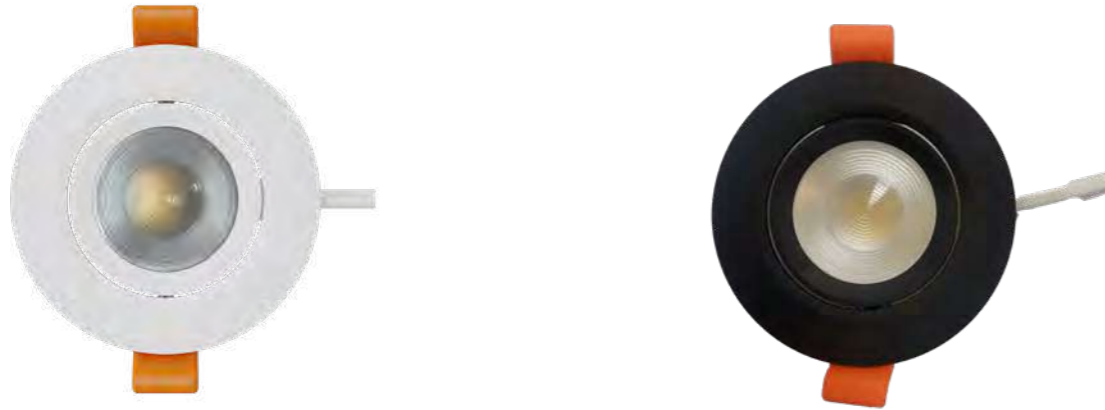

REFERENCE	CCT switch	LED WATT	LUMENS	FINISH
8762	3000K-4000K-5000K	6W	480lm	Blanco-White
8763	3000K-4000K-5000K	6W	480lm	Negro-Black
220-240V~ 50/60Hz CRI: ≥ 80				Aluminio/PC-Aluminium/PC

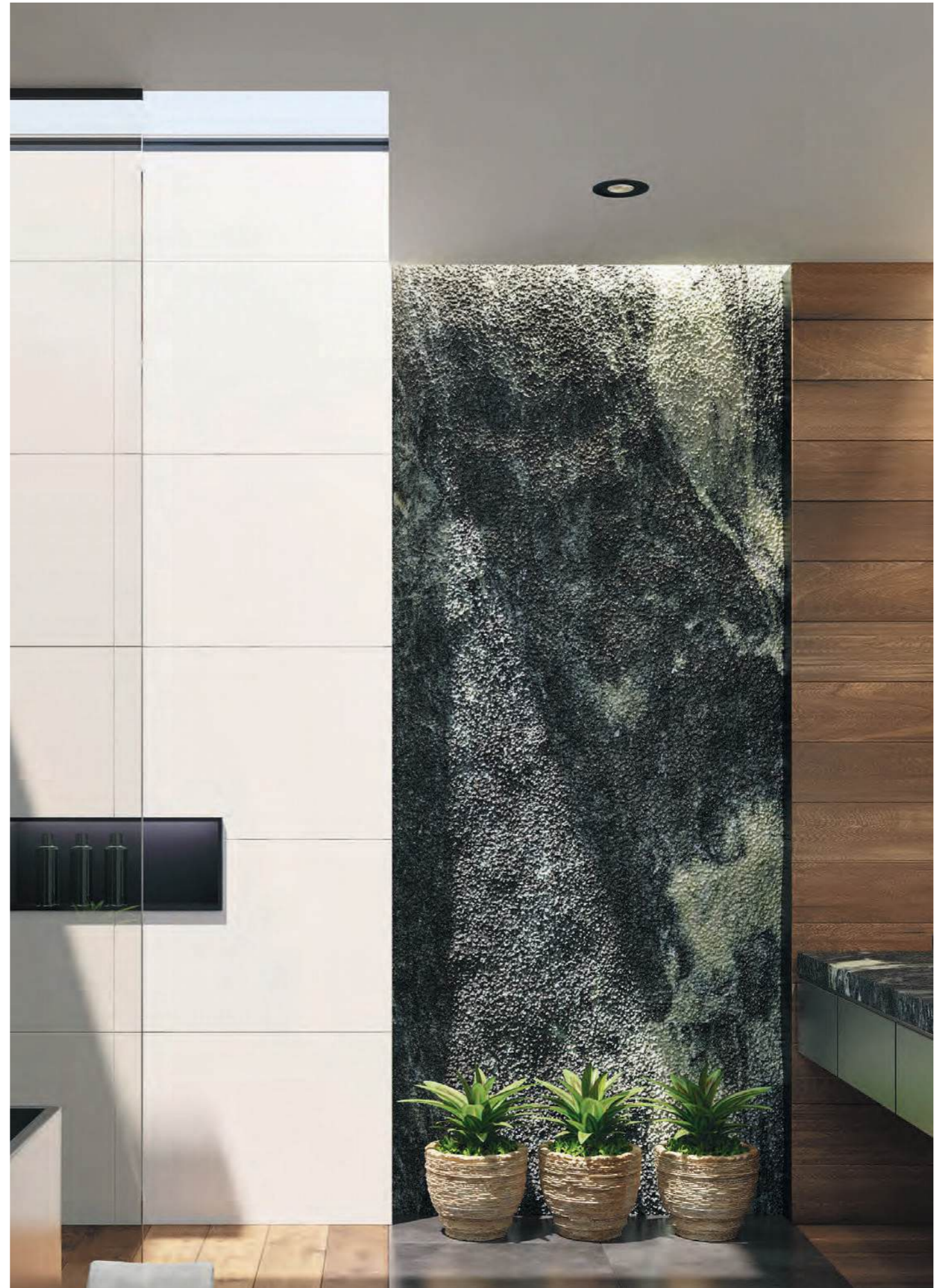
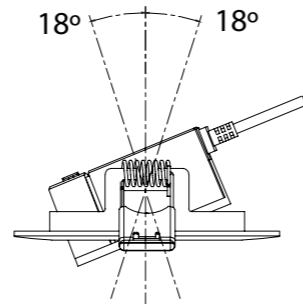



C0073-C0074



C0071-C0072



C0077-C0078



C0075-C0076

REFERENCE	K	LED WATT	LUMENS	FINISH
C0071	3000K	7W	610lm	Blanco mate-Matt white
C0072	4000K	7W	650lm	Blanco mate-Matt white
C0073	3000K	12W	1040lm	Blanco mate-Matt white
C0074	4000K	12W	1080lm	Blanco mate-Matt white
220-240V ~ 50/60Hz CRI: ≥ 80				Aluminio-Aluminium

REFERENCE	K	LED WATT	LUMENS	FINISH
C0075	3000K	7W	610lm	Blanco mate-Matt white
C0076	4000K	7W	650lm	Blanco mate-Matt white
C0077	3000K	12W	1040lm	Blanco mate-Matt white
C0078	4000K	12W	1080lm	Blanco mate-Matt white
220-240V ~ 50/60Hz CRI: ≥ 80				Aluminio-Aluminium

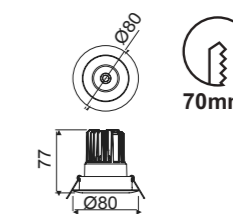
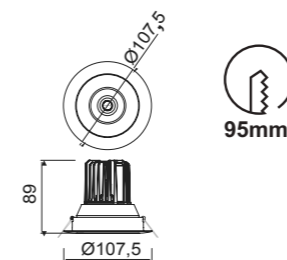
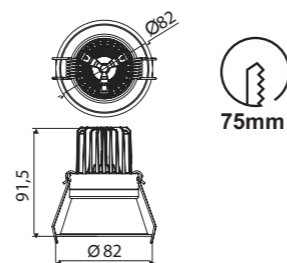
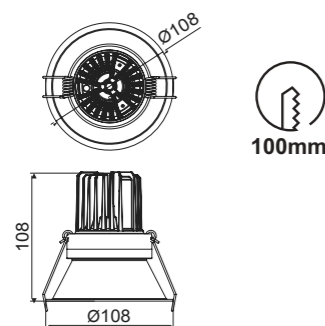

C0073

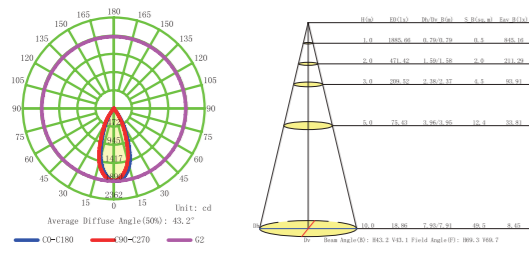

C0077

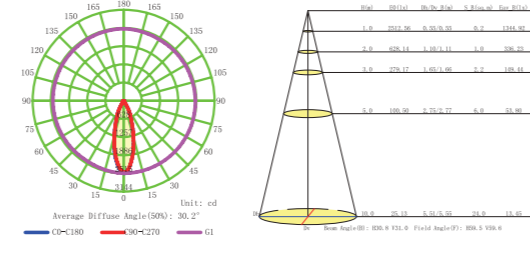

C0074

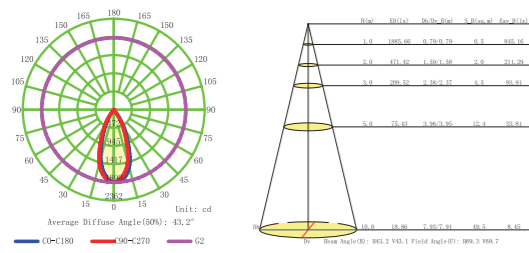

C0078

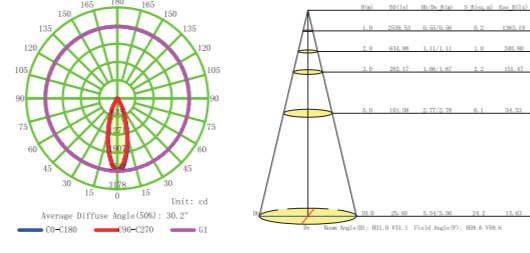

C0071

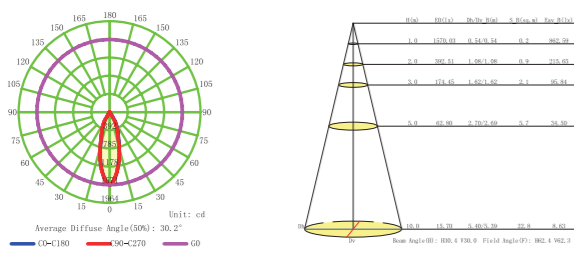

C0075

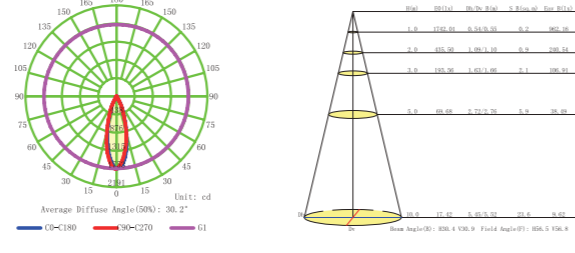

C0072

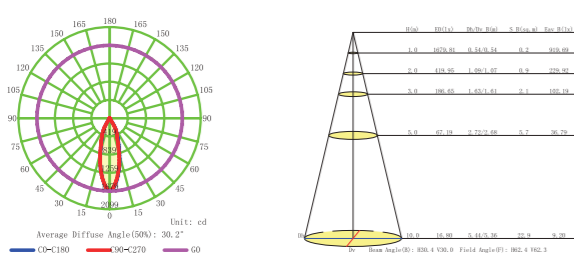

C0076

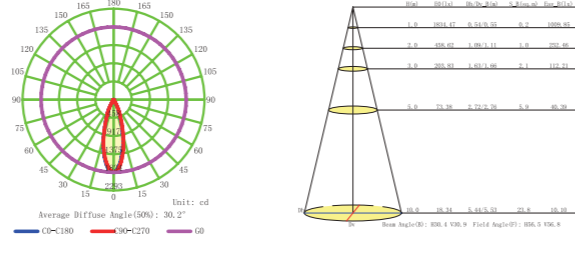



REFERENCE	K	LED WATT	LUMENS	FINISH
7829	2700K	7W	610lm	Blanco-White
7831	2700K	7W	610lm	Negro-Black
6400	3000K	7W	610lm	Blanco-White
7833	3000K	7W	610lm	Negro-Black
6401	4000K	7W	630lm	Blanco-White
7830	2700K	12W	1020lm	Blanco-White
7832	2700K	12W	1020lm	Negro-Black
6402	3000K	12W	1020lm	Blanco-White
7834	3000K	12W	1020lm	Negro-Black
6403	4000K	12W	1080lm	Blanco-White

220-240V~ 50/60Hz CRI:≥ 80

Aluminio ABS -Aluminium

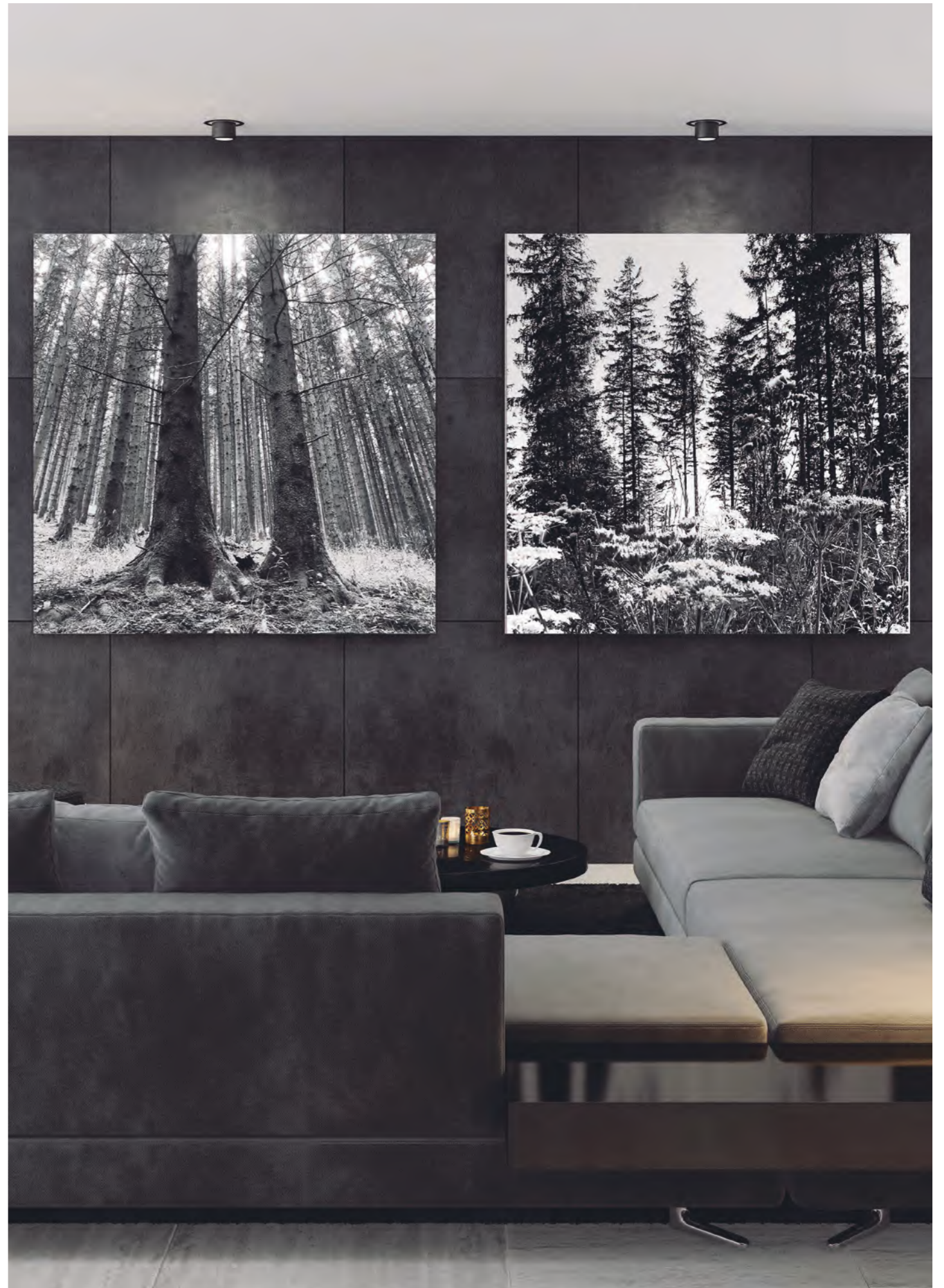
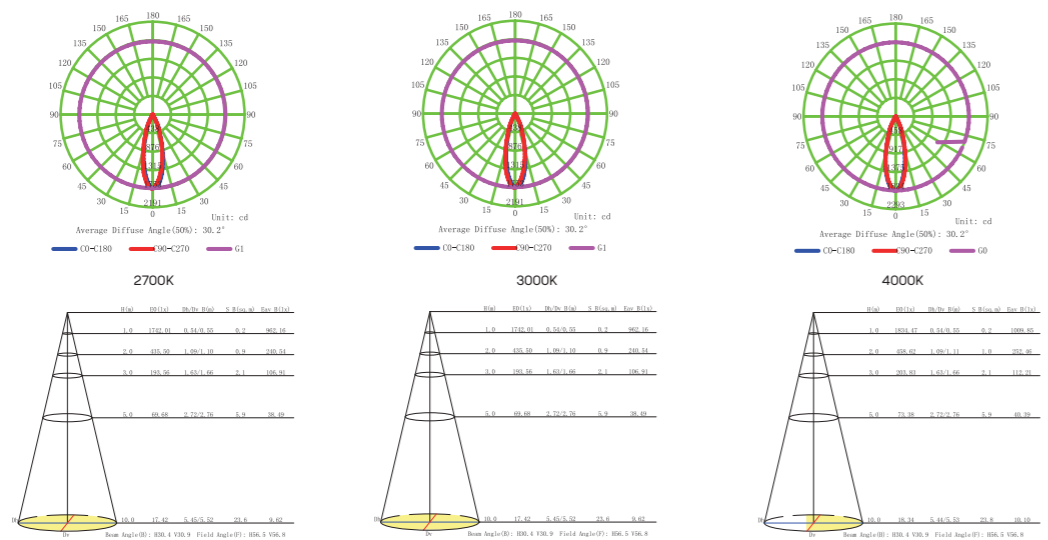

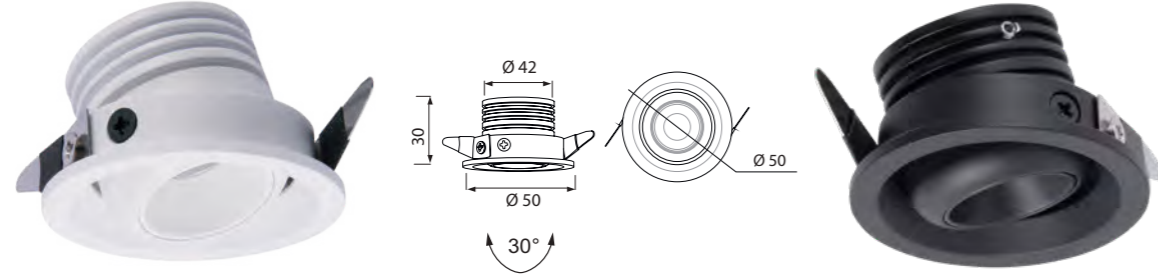

REFERENCE	K	LED WATT	LUMENS	FINISH
7827	2700K	3W	210lm	Blanco-White
7828	2700K	3W	210lm	Negro-Black
7451	3000K	3W	210lm	Blanco-White
7453	3000K	3W	210lm	Negro-Black
7452	4000K	3W	220lm	Blanco-White
7454	4000K	3W	220lm	Negro-Black

100-240V~ 50/60Hz CRI:≥ 90 Aluminio-Aluminium

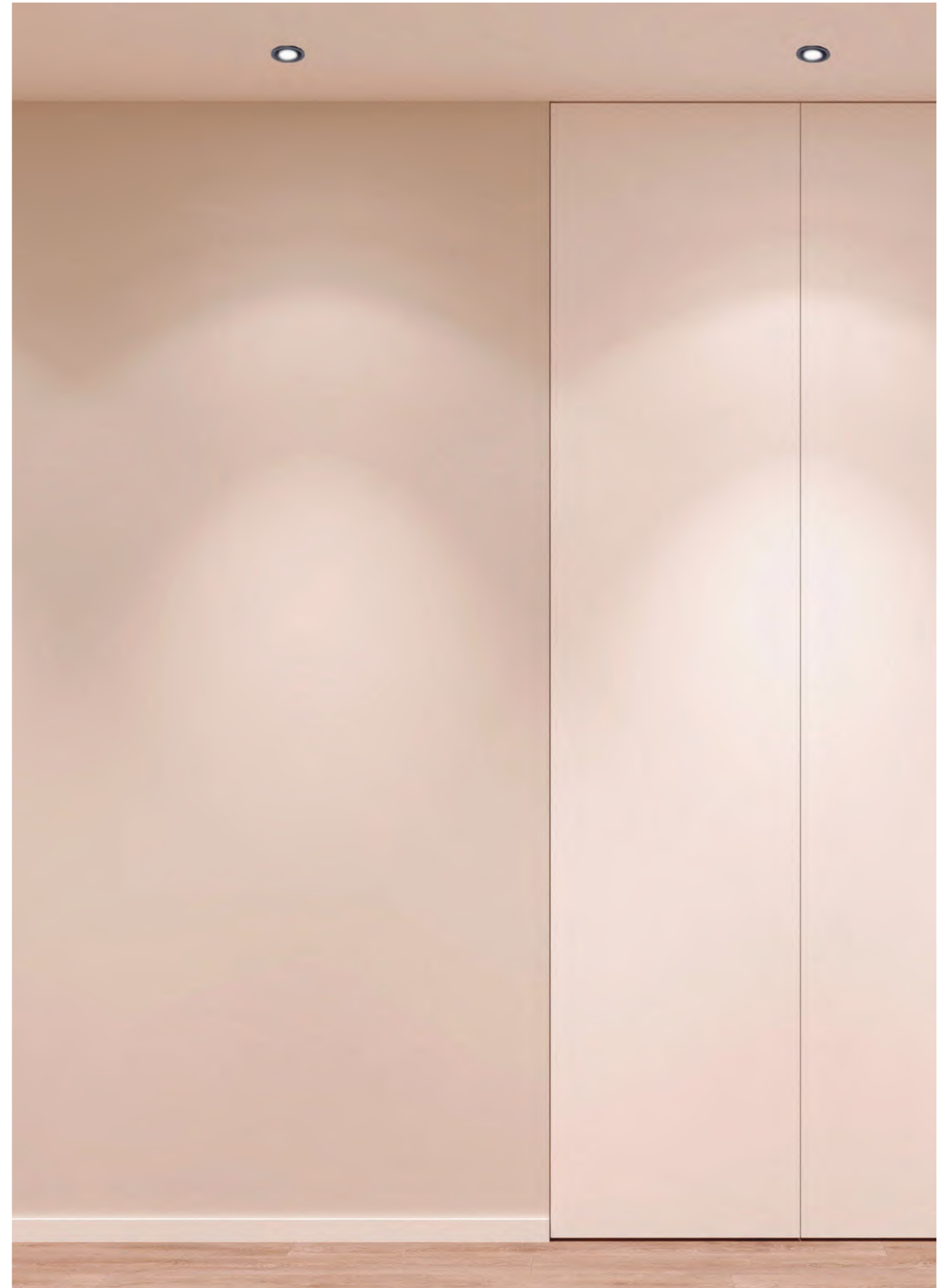

Luminous Intensity Distribution Curve

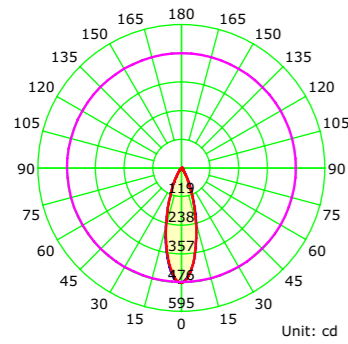

Luminous Intensity Distribution Curve

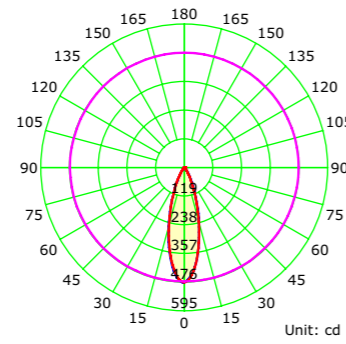

Luminous Intensity Distribution Curve

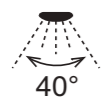
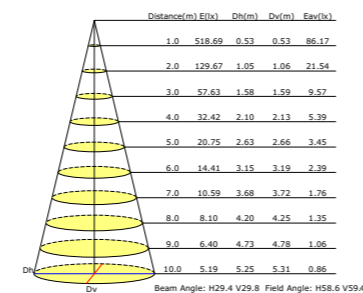
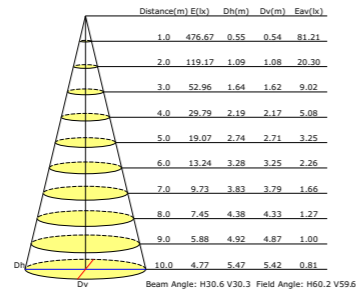
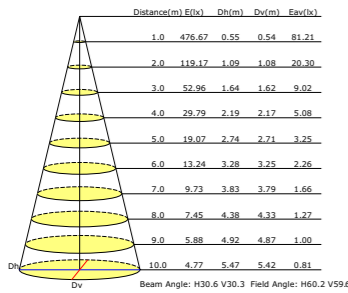
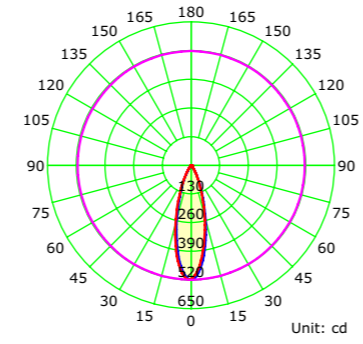

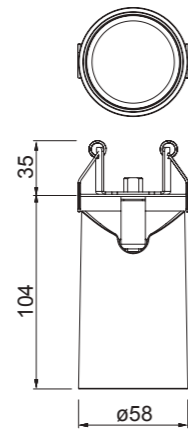

REFERENCE	BULBS NOT INCLUDED	FINISH
8295	1 x GU10	Blanco mate-Matt white
8296	1 x GU10	Negro mate-Matt black
máx. 10W LED (No incl)		100-240V ~ 50/60Hz Aluminio-Aluminium



Bombillas recomendadas-Suggested bulbs

K	Wat LED	Reference
3000K	6W	R09196
4000K	6W	R09214
5000K	6W	R09197



8297 pág. 120 7961 pág. 90 6281 pág. 180 7523 pág. 58



6717 pág. 238 6283 pág. 60 7520 pág. 158 7522 pág. 168



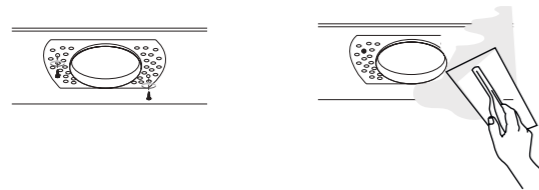
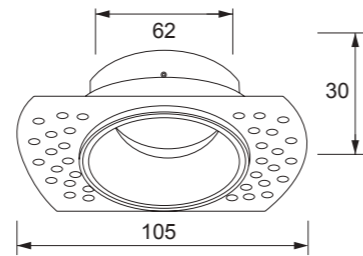
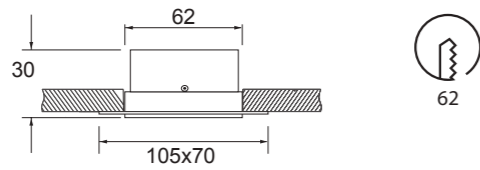

REFERENCE	BULB NO INCLUDED	FINISH
8664	1 x GU10	Blanco-White
8665	1 x GU10	Negro-Black
GU10 máx 12W Led		100-240V~ 50/60Hz Aluminio-Aluminium

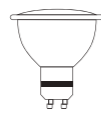

Bombillas recomendadas-Suggested bulbs

K	Wat LED	On/Off	Dimmable	Lumens
2700K	7W	R09254	R09257	510lm
3000K	7W	R09255	R09258	540lm
4000K	7W	R09256	R09259	570lm



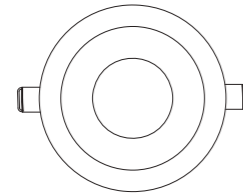
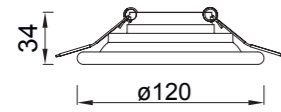

2 Opciones de montaje-2 assembly options

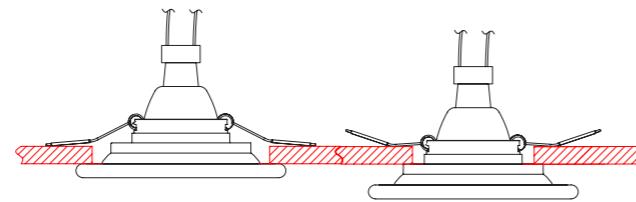

Plano-Flat

Flotación-Float



ø95-100mm



ø60-70mm

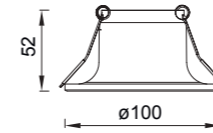

75-85

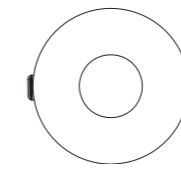

REFERENCE	BULB NO INCLUDED	FINISH
8688	1 × GU10	Blanco-White
	GU10 máx 12W Led	100-240V~ 50/60Hz Policarbonato-Polycarbonate

REFERENCE	BULB NO INCLUDED	FINISH
8689	1 × GU10	Blanco-White
	GU10 máx 12W Led	100-240V~ 50/60Hz Policarbonato-Polycarbonate

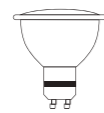

Bombillas recomendadas-Suggested bulbs

K	Wat LED	On/Off	Dimmable	Lumens
2700K	7W	R09254	R09257	510lm
3000K	7W	R09255	R09258	540lm
4000K	7W	R09256	R09259	570lm



NOT INCLUDED



3 años de garantía



IP20



GUINCHO GU10

Empotrable-Recessed

Indoor

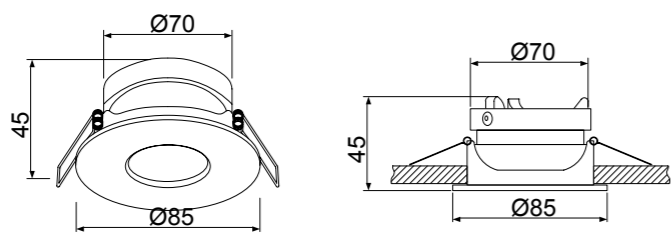

REFERENCE	BULB NO INCLUDED	FINISH
7535	1 x GU10	Blanco arena-Sand white
7536	1 x GU10	Negro arena-Sand black
GU10 máx 10W Led		100-240V~ 50/60Hz Aluminio-Aluminium

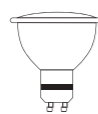

Bombillas recomendadas-Suggested bulbs

K	Wat LED	On/Off	Dimmable	Lumens
2700K	7W	R09254	R09257	510lm
3000K	7W	R09255	R09258	540lm
4000K	7W	R09256	R09259	570lm



70mm



NOT INCLUDED



3 años
WARRANTY
GARANTIA



IP20



BÁSICO GU10

Empotrable-Recessed

Indoor

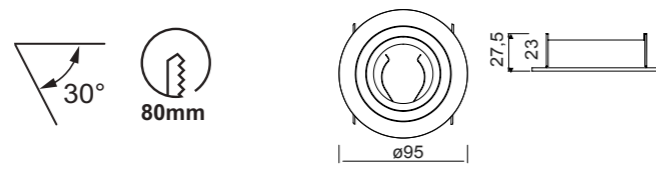

REFERENCE	BULB NO INCLUDED	FINISH
7740	1 x GU10	Nickel Satinado/Cromo-Satin Nickel/Chrome
7741	1 x GU10	Blanco mate-Matt white
7742	1 x GU10	Aluminio Pulido-Polished Aluminium
7743	1 x GU10	Negro mate-Matt black
GU10 máx 12W Led		100-240V~ 50/60Hz Aluminio-Aluminium

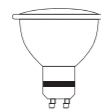

Bombillas recomendadas-Suggested bulbs

K	Wat LED	On/Off	Dimmable	Lumens
2700K	7W	R09254	R09257	510lm
3000K	7W	R09255	R09258	540lm
4000K	7W	R09256	R09259	570lm



BÁSICO GU10

Empotrable-Recessed

Indoor

C0002

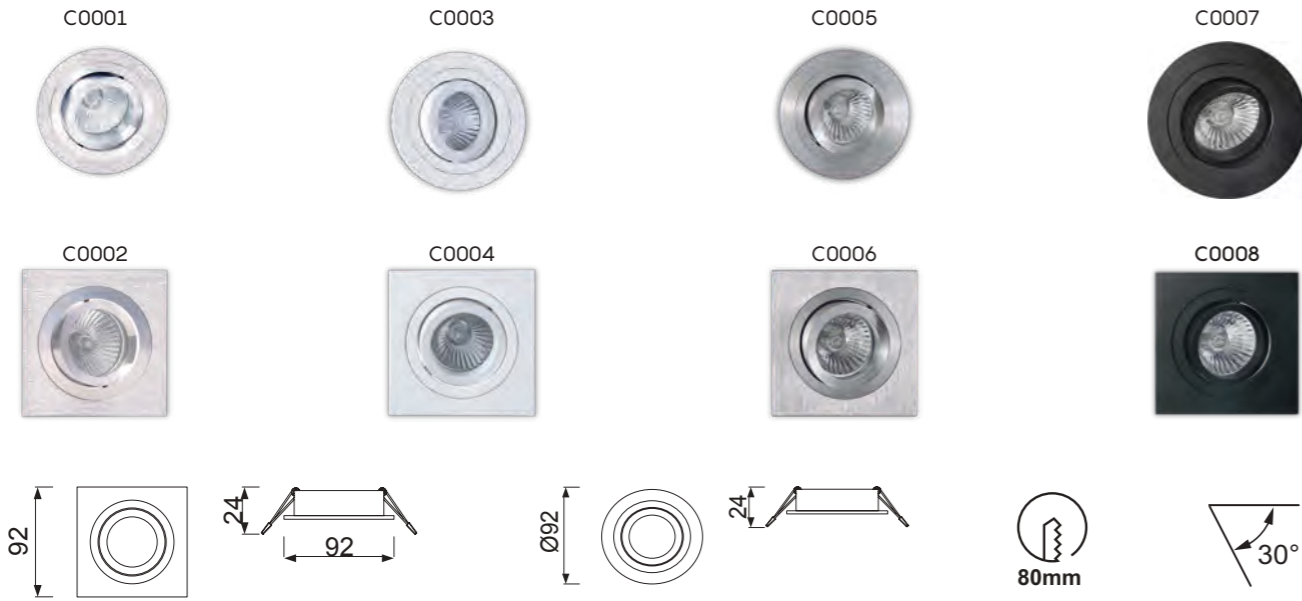

REFERENCE	BULB NO INCLUDED	FINISH
C0001	1 x GU10	Nickel Satinado/Cromo-Satin Nickel/Chrome
C0002	1 x GU10	Nickel Satinado/Cromo-Satin Nickel/Chrome
C0003	1 x GU10	Blanco mate-Matt white
C0004	1 x GU10	Blanco mate-Matt white
C0005	1 x GU10	Aluminio Pulido-Polished Aluminium
C0006	1 x GU10	Aluminio Pulido-Polished Aluminium
C0007	1 x GU10	Negro mate-Matt black
C0008	1 x GU10	Negro mate-Matt black
GU10 máx 12W Led		100-240V~ 50/60Hz Aluminio-Aluminium



Bombillas recomendadas-Suggested bulbs

K	Wat LED	On/Off	Dimmable	Lumens
2700K	7W	R09254	R09257	510lm
3000K	7W	R09255	R09258	540lm
4000K	7W	R09256	R09259	570lm



COMFORT GU10

Empotrable-Recessed

Indoor

C0160



REFERENCE	BULB NO INCLUDED	FINISH
C0160	1 × GU10	Blanco mate-Matt white
C0161	1 × GU10	Plata mate-Matt silver
C0164	1 × GU10	Negro mate-Matt black
GU10 máx 12W Led		100-240V~ 50/60Hz Aluminio-Aluminium

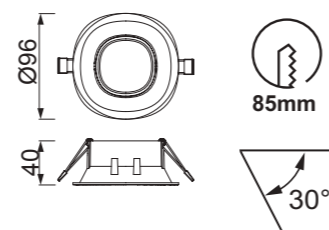

REFERENCE	BULB NO INCLUDED	FINISH
C0162	1 × GU10	Blanco mate-Matt white
C0163	1 × GU10	Plata mate-Matt silver
C0165	1 × GU10	Negro mate-Matt black
GU10 máx 12W Led		100-240V~ 50/60Hz Aluminio-Aluminium

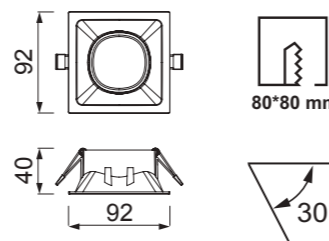

ErP COMPLIANT

RoHS compliant

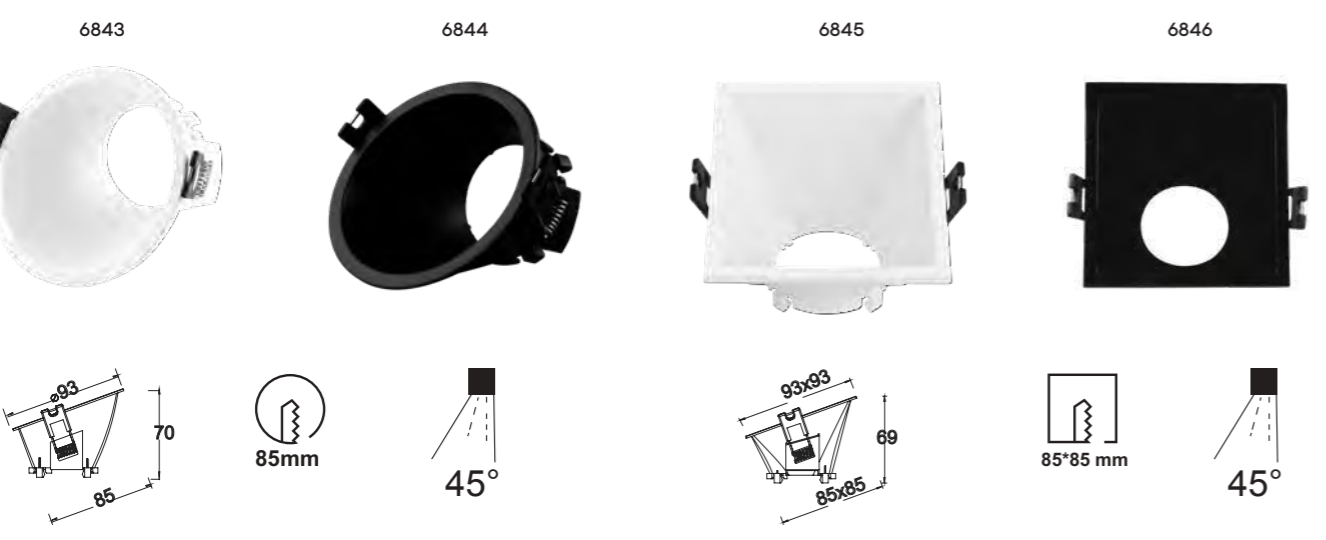
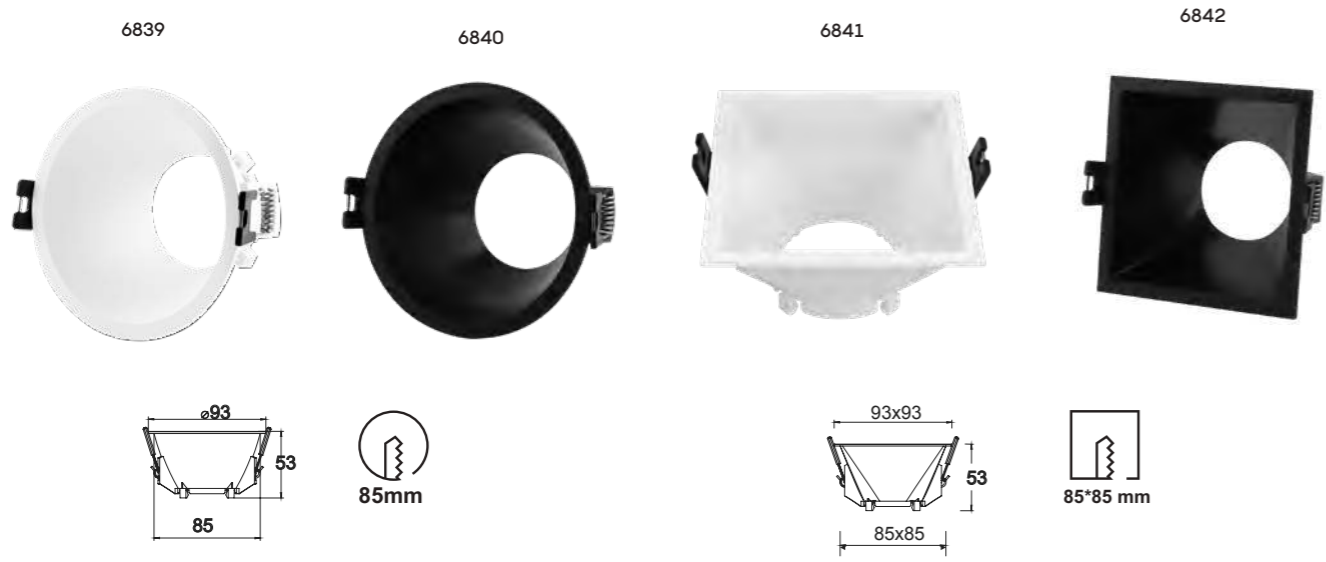

REFERENCE	BULB NO INCLUDED	FINISH
6839	1 x GU10	Blanco mate-Matt white
6840	1 x GU10	Negro mate-Matt black
6843	1 x GU10	Blanco mate-Matt white
6844	1 x GU10	Negro mate-Matt black
6841	1 x GU10	Blanco mate-Matt white
6842	1 x GU10	Negro mate-Matt black
6845	1 x GU10	Blanco mate-Matt white
6846	1 x GU10	Negro mate-Matt black
GU10 máx 12W Led		100-240V~ 50/60Hz PCB by samsung

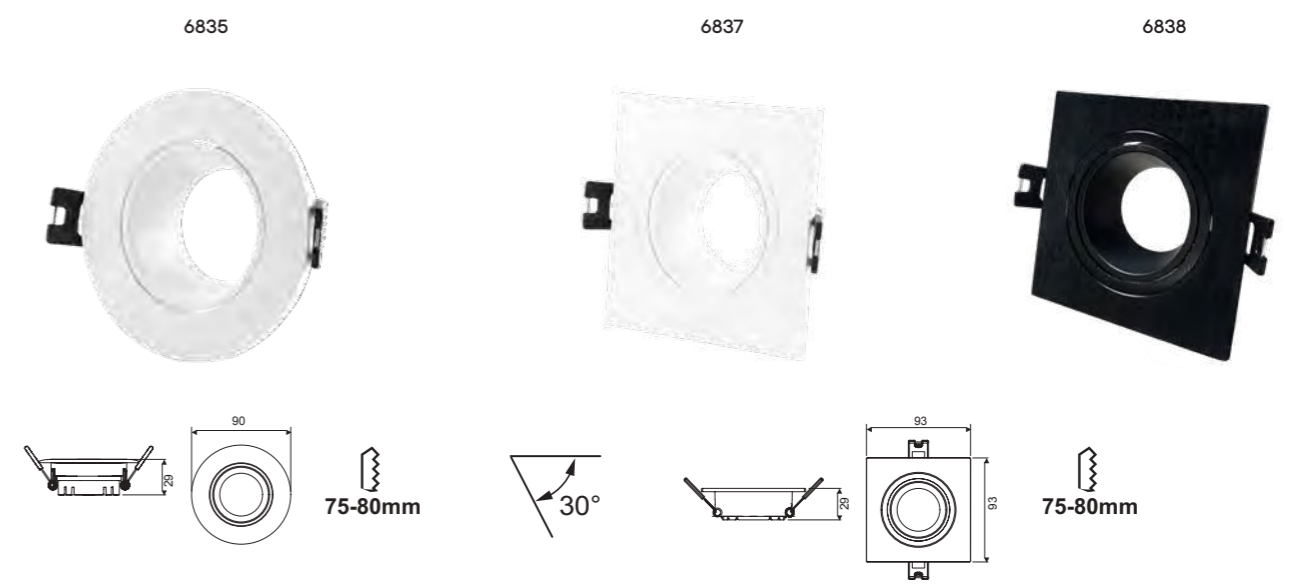

REFERENCE	BULB NO INCLUDED	FINISH
6835	1 x GU10	Blanco mate-Matt white
6837	1 x GU10	Blanco mate-Matt white
6838	1 x GU10	Negro mate-Matt black
GU10 máx 12W Led		100-240V~ 50/60Hz PCB by samsung



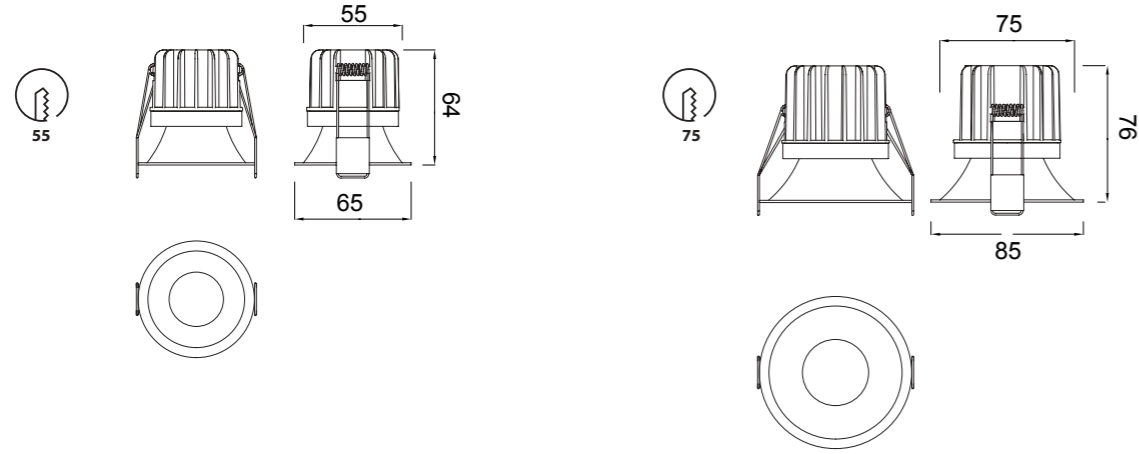

REFERENCE	CCT	LED WATT	LUMENS	FINISH
8764	2700K/3000K/4000K	8W	720lm	Blanco-White
8765	2700K/3000K/4000K	8W	720lm	Negro-Black
8766	2700K/3000K/4000K	12W	1080lm	Blanco-White
8767	2700K/3000K/4000K	12W	1080lm	Negro-Black
200-240V~ 50/60Hz CRI:≥ 80				Aluminio-Aluminium

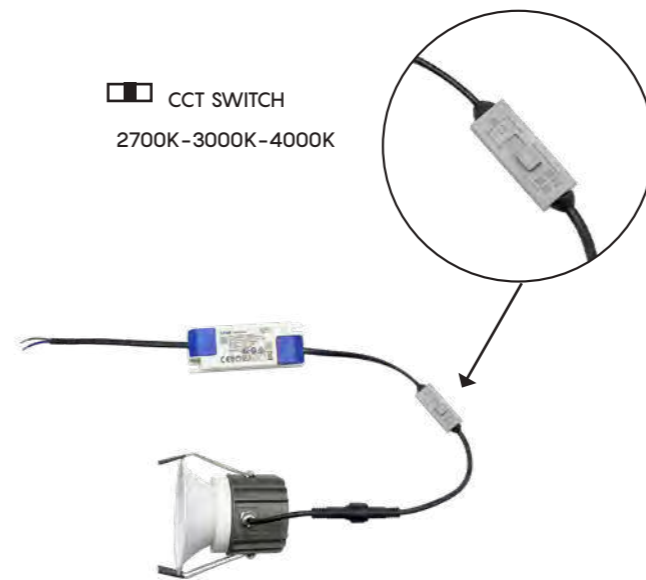

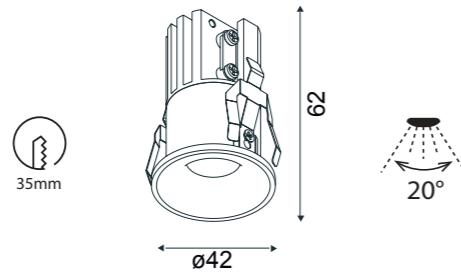

REFERENCE	K	LED WATT	LUMENS	FINISH
8666	2700K	7W	505lm	Blanco arena-Sand white
8669	2700K	7W	505lm	Negro arena-Sand black
8667	3000K	7W	520lm	Blanco arena-Sand white
8670	3000K	7W	520lm	Negro arena-Sand black
8668	4000k	7W	535lm	Blanco arena-Sand white
8671	4000k	7W	535lm	Negro arena-Sand black
200-240V - 50/60Hz CRI:≥ 90				Aluminio-Aluminium



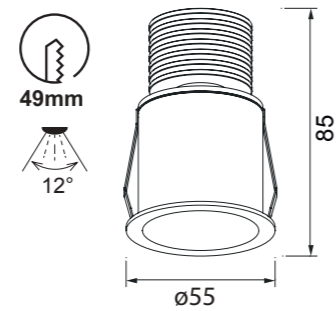
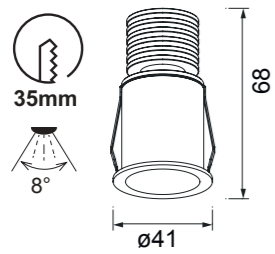

REFERENCE	K	LED WATT	LUMENS	FINISH
7080	2700K	3W	210lm	Blanco arena-Sand white
7081	2700K	3W	210lm	Negro arena-Sand black
6855	3000K	3W	210lm	Blanco arena-Sand white
6856	3000K	3W	210lm	Negro arena-Sand black
6859	4000k	3W	210lm	Blanco arena-Sand white
6860	4000k	3W	210lm	Negro arena-Sand black
7082	2700K	5W	410lm	Blanco arena-Sand white
7083	2700K	5W	410lm	Negro arena-Sand black
6857	3000K	5W	410lm	Blanco arena-Sand white
6858	3000K	5W	410lm	Negro arena-Sand black
6861	4000k	5W	410lm	Blanco arena-Sand white
6862	4000k	5W	410lm	Negro arena-Sand black
200-240V~ 50/60Hz CRI:≥ 80				Aluminio-Aluminium

6855-6856

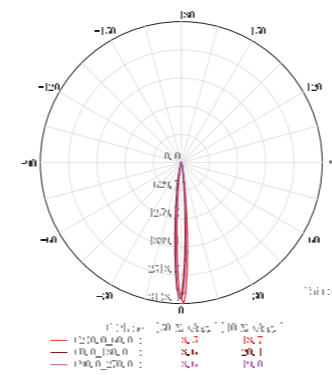

6857-6858

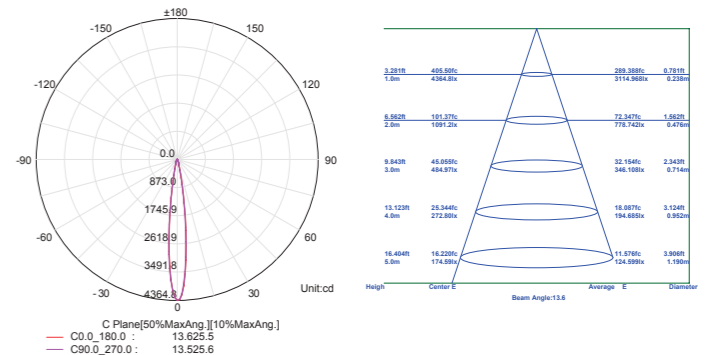

7080-7081

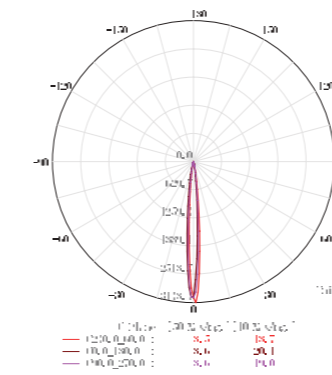

7082-7083

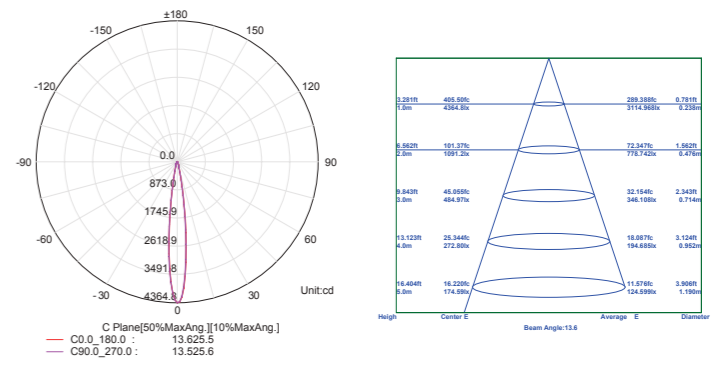



REFERENCE	K	LED WATT	LUMENS	FINISH
C0083	3000K	7W	490lm	Blanco mate-Matt white
C0084	4000K	7W	520lm	Blanco mate-Matt white
			220-240V~ 50/60Hz CRI:≥ 80	Aluminio-Aluminium

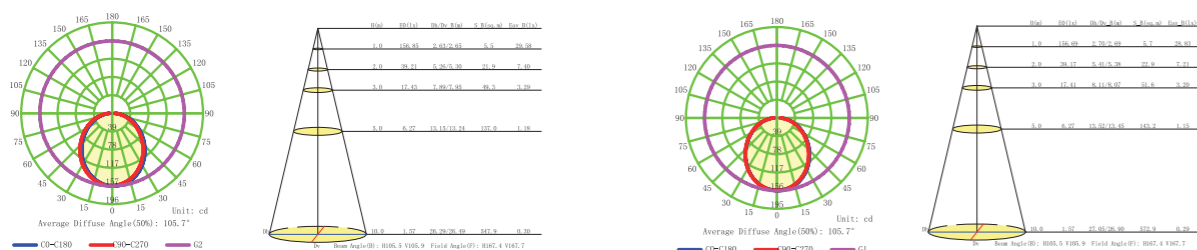
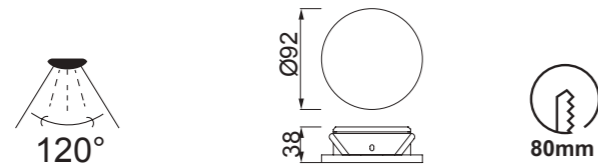

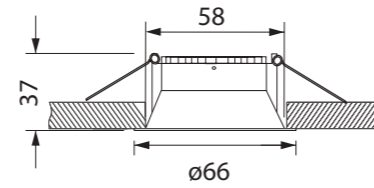
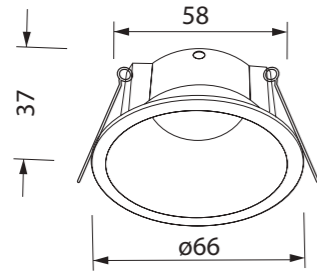

REFERENCE	BULB NO INCLUDED	FINISH
8660	1 × mini GU10	Blanco-White
8661	1 × mini GU10	Negro-Black
GU10 máx 12W Led 100-240V - 50/60Hz		Aluminio-Aluminium

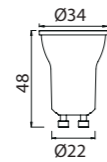

Bombillas recomendadas-Suggested bulbs

K	Wat LED	On/Off	Lumens
2700K	4W	R09280	290lm
3000K	4W	R09281	310lm
4000K	4W	R09282	330m



TAVIRA
New

Empotrable-Recessed

Indoor

IP54

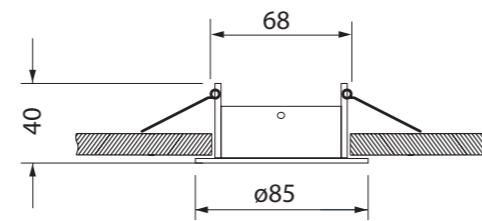
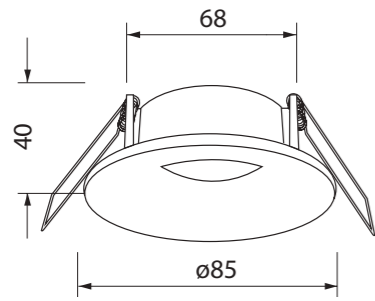

REFERENCE	BULB NO INCLUDED	FINISH
8654	1 x GU10	Blanco-White
8655	1 x GU10	Negro-Black
GU10 máx 12W Led 100-240V - 50/60Hz		Aluminio-Aluminium

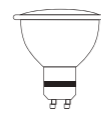

Bombillas recomendadas-Suggested bulbs

K	Wat LED	On/Off	Dimmable	Lumens
2700K	7W	R09254	R09257	510lm
3000K	7W	R09255	R09258	540lm
4000K	7W	R09256	R09259	570lm



TAVIRA
New

Empotrable-Recessed

Indoor

IP54

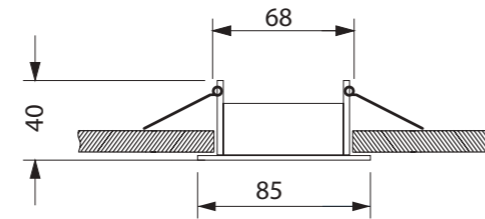
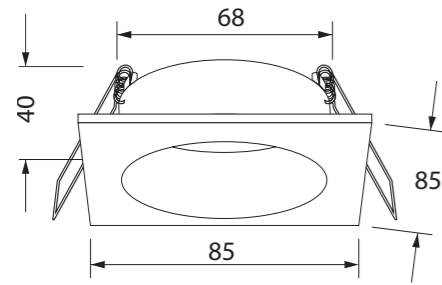

REFERENCE	BULB NO INCLUDED	FINISH
8656	1 x GU10	Blanco-White
8657	1 x GU10	Negro-Black
GU10 máx 12W Led 100-240V - 50/60Hz		Aluminio-Aluminium

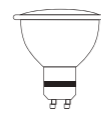

Bombillas recomendadas-Suggested bulbs

K	Wat LED	On/Off	Dimmable	Lumens
2700K	7W	R09254	R09257	510lm
3000K	7W	R09255	R09258	540lm
4000K	7W	R09256	R09259	570lm



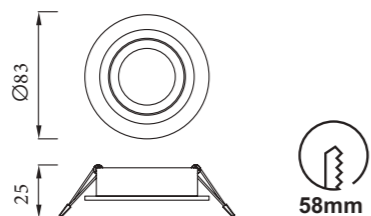

REFERENCE	BULB NO INCLUDED	FINISH
6405	1 x GU10	Blanco mate-Matt white
6406	1 x GU10	Aluminio Plata-Silver Aluminium
	GU10 máx 12W Led 100-240V~ 50/60Hz	Aluminio-Aluminium



Bombillas recomendadas-Suggested bulbs

K	Wat LED	On/Off	Dimmable	Lumens
2700K	7W	R09254	R09257	510lm
3000K	7W	R09255	R09258	540lm
4000K	7W	R09256	R09259	570lm



6810

6811

6812

6813

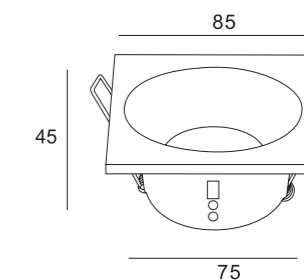
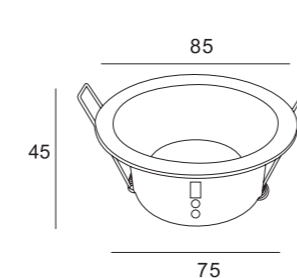
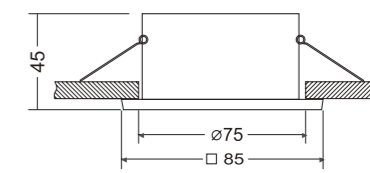
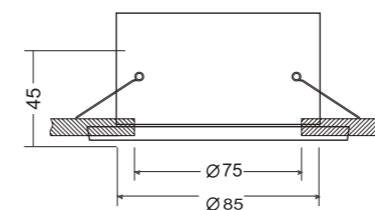
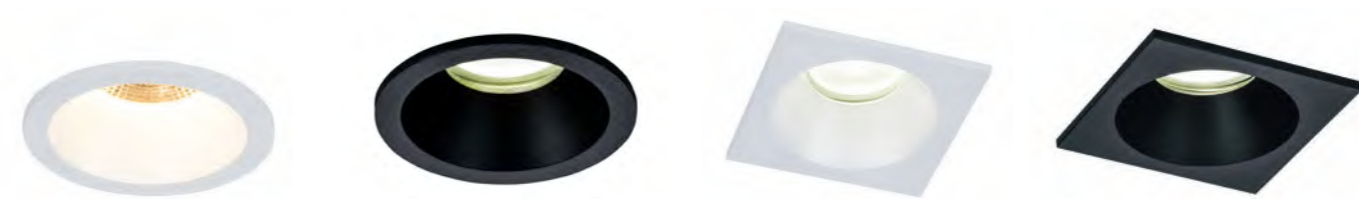

REFERENCE	BULB NO INCLUDED	FINISH	SIZES
6810	1 x GU10	Blanco mate-Matt white	o 8.5x4.5cm
6811	1 x GU10	Negro mate-Matt black	o 8.5x4.5cm
6812	1 x GU10	Blanco mate-Matt white	4.5x8.5x8.5cm
6813	1 x GU10	Negro mate-Matt black	4.5x8.5x8.5cm
	GU10 máx 12W Led 100-240V~ 50/60Hz	Aluminio-Aluminium	



Tiras Led Strip Leds

TIRAS-STRIPS

Tira LED flexible para uso interior IP20
IP20 Flexible LED strip for indoor lighting

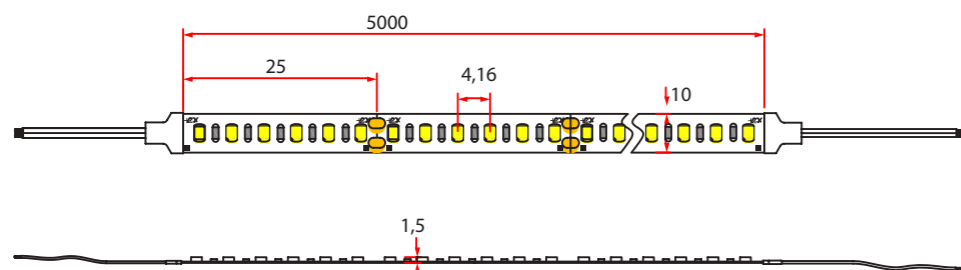

Características técnicas / Technical characteristics

Ref.	Color Colour	Color temp. Colour T°	Tensión DC voltage DC	Ud. LED metro LED units meter	Potencia por metro Power meter	Eficiencia luminosa metro Luminous efficacy meter	Eficiencia luminosa vatio Luminous efficacy watt	CRI	SDCM	Ancho Wide	Corte Cut	Ud. LED corte LED units cut	Metros rollo Meters reel	Protección Protection
	K	V		W/m	lm/m*	lm/W			mm	mm	pcs	m	IP	
7366	●	2700	24	240	19,2	1594	83	≥ 90	< 3	10	25	6	5	20
7367	●	3000	24	240	19,2	1651	86	≥ 90	< 3	10	25	6	5	20
7368	○	4000	24	240	19,2	1709	89	≥ 90	< 3	10	25	6	5	20



24V CRI: >90 tc < 65°

TIRAS-STRIPS

Tira LED flexible para uso interior. IP20
IP20 Flexible LED strip for indoor use

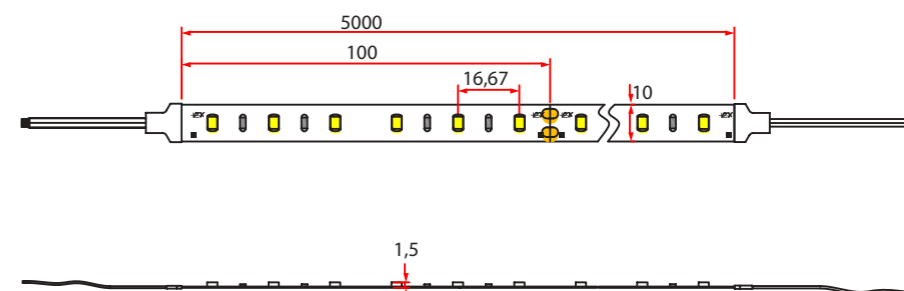

Características técnicas / Technical characteristics

Ref.	Color Colour	Color temp. Colour T°	Tensión DC voltage DC	Ud. LED metro LED units meter	Potencia por metro Power meter	Eficiencia luminosa metro Luminous efficacy meter	Eficiencia luminosa vatio Luminous efficacy watt	CRI	SDCM	Ancho Wide	Corte Cut	Ud. LED corte LED units cut	Metros rollo Meters reel	Protección Protection
	K	V		W/m	lm/m*	lm/W			mm	mm	pcs	m	IP	
7360	●	2700	24	60	9,6	730	76	≥ 90	< 3	10	100	6	5	20
7361	●	3000	24	60	9,6	759	79	≥ 90	< 3	10	100	6	5	20
7362	○	4000	24	60	9,6	787	82	≥ 90	< 3	10	100	6	5	20



24V CRI: >90 tc < 65°

TIRAS-STRIPS

Indoor

Tira LED flexible para uso interior. IP20
IP20 Flexible LED strip for indoor use

Características técnicas / Technical characteristics

Ref.	Color Colour	Color temp. Colour T°	Tensión DC voltage DC	Ud. LED metro LED units meter	Potencia por metro Power meter	Eficiencia luminosa metro Luminous efficacy meter	Eficiencia luminosa vatio Luminous efficacy watt	CRI	SDCM	Ancho Wide	Corte Cut	Ud. LED corte LED units cut	Metros rollo Meters reel	Protección Protection
7363	●	2700	24	120	14,4	1051	73	≥ 90	< 3	8	50	6	5	20
7364	●	3000	24	120	14,4	1109	77	≥ 90	< 3	8	50	6	5	20
7365	○	4000	24	120	14,4	1152	80	≥ 90	< 3	8	50	6	5	20

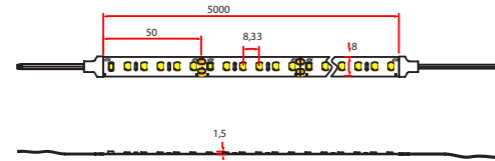

Características técnicas / Technical characteristics

Ref.	Color Colour	Color temp. Colour T°	Tensión DC voltage DC	Ud. LED metro LED units meter	Potencia por metro Power meter	Eficiencia luminosa metro Luminous efficacy meter	Eficiencia luminosa vatio Luminous efficacy watt	CRI	SDCM	Ancho Wide	Corte Cut	Ud. LED corte LED units cut	Metros rollo Meters reel	Protección Protection
New 8649	●	3000	24	240	14,4	2448	170	≥ 80	< 3	10	33	8	5	20
New 8650	○	4000	24	240	14,4	2491	173	≥ 80	< 3	10	33	8	5	20

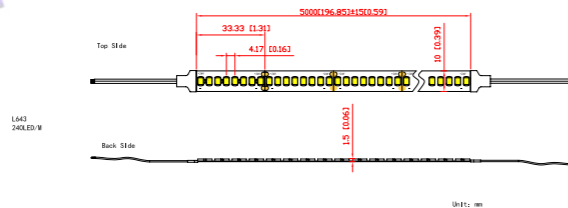

TIRAS-STRIPS

Tira LED flexible para uso exterior IP65
IP65 Flexible LED strip for outdoor lighting

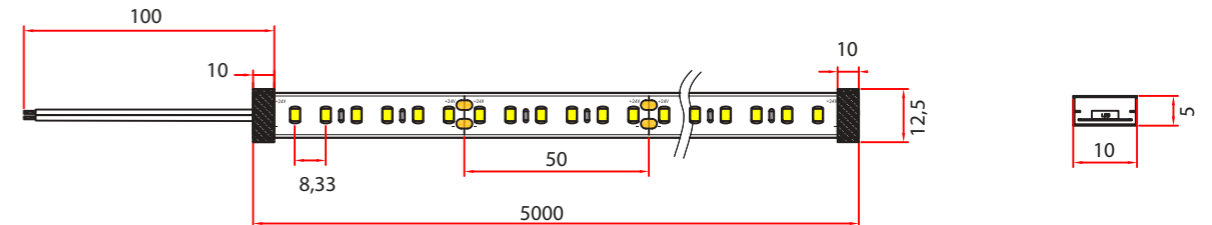
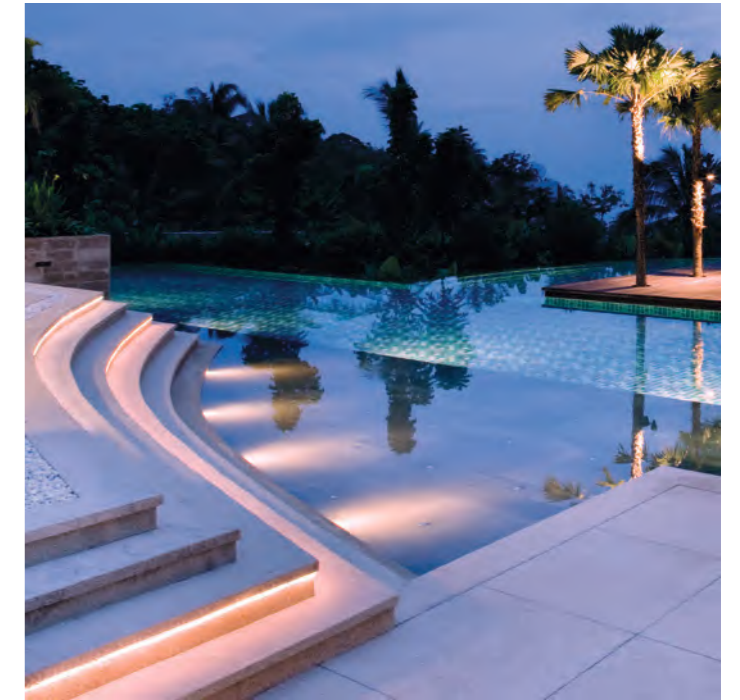

Características técnicas / Technical characteristics

Ref.	Color Colour	Color temp. Colour T°	Tensión DC voltage DC	Ud. LED metro LED units meter	Potencia por metro Power meter	Eficiencia luminosa metro Luminous efficacy meter	Eficiencia luminosa vatio Luminous efficacy watt	CRI	SDCM	Ancho Wide	Corte Cut	Ud. LED corte LED units cut	Metros rollo Meters reel	Protección Protection
7369	●	3000	24	120	14,4	1109	77	≥ 90	< 3	10	50	6	5	65
7370	○	4000	24	120	14,4	1152	80	≥ 90	< 3	10	50	6	5	65

Accesorios de corte IP no incluidos / IP Cutting accessories not included



7406 Conexión estanca DC/Waterproof connection

7404 Pegamento silicona/Silicone glue

7403 Final silicona con agujeros
Silicone end cap w/holes

7405 Final silicona/Silicone End cap



24V CRI: > 90 tc < 65°



24V CRI: > 90 tc < 65°

PERFILES - PROFILES

Perfil para tiras LED
Profile for LED strips

Indoor



7381 Blanco-White

7382 Negro-Black

7383 Aluminio-Aluminium

Piezas incluidas/Included pieces

Piezas incluidas/Included pieces

Piezas incluidas/Included pieces



Perfil+difusor/Profile+diffuser

Perfil+difusor/Profile+diffuser

Perfil+difusor/Profile+diffuser

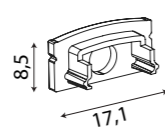
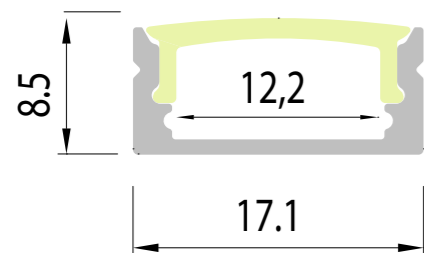

Tapa/End cap

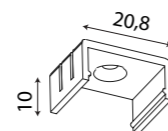

Clip PC transparent

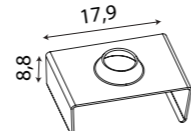

Clip aluminium



Aluminio+PCB/Aluminium+PCB

PERFILES - PROFILES

Perfil para tiras LED
Profile for LED strips

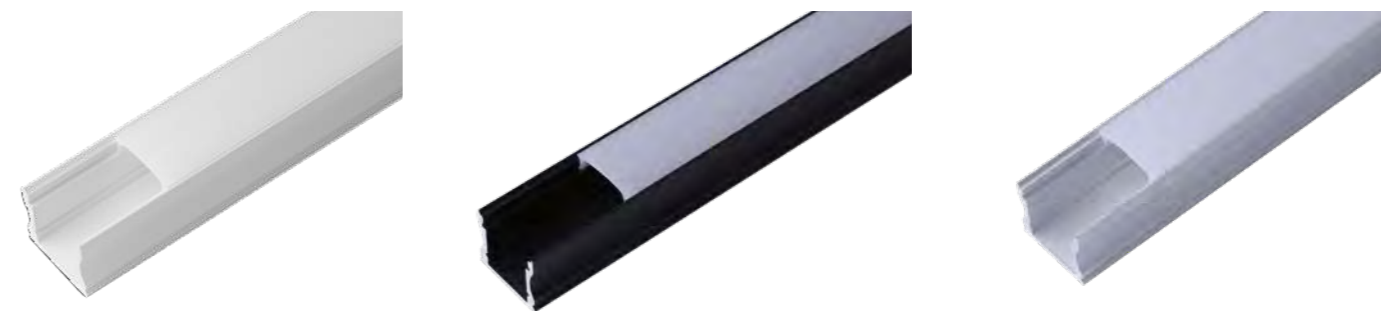

7392 Blanco-White

7393 Negro-Black

7394 Aluminio-Aluminium

Piezas incluidas/Included pieces

Piezas incluidas/Included pieces

Piezas incluidas/Included pieces



Perfil+difusor/Profile+diffuser

Perfil+difusor/Profile+diffuser

Perfil+difusor/Profile+diffuser

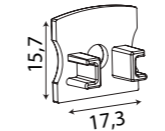

Tapa/End cap

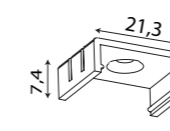

Clip PC transparent

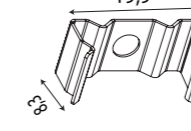

Clip aluminium



Aluminio+PCB/Aluminium+PCB

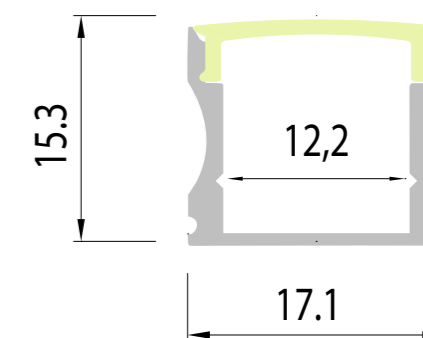

PERFILES - PROFILES

Perfil empotrado para suelo
LED Strip Profile recessed in ground



8064 Aluminio-Aluminium

Piezas incluidas/Included pieces

2 m	
Perfil+difusor/Profile+diffuser	
2 x 8065	
2 x 8066	

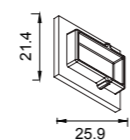
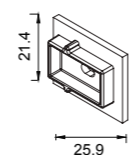
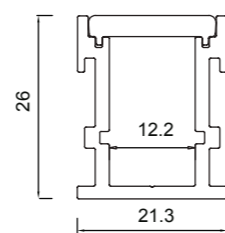

Aluminio+PCB/Aluminium+PCB

Indoor

PERFILES - PROFILES

Perfil para esquinas
Profiles for corners



7417 Blanco-White

7418 Negro-Black

Piezas incluidas/Included pieces

Piezas incluidas/Included pieces

2 m		2 m	
Perfil+difusor/Profile+diffuser		Perfil+difusor/Profile+diffuser	
2 x 8060		2 x 8061	
2 x 8062		2 x 8063	
4 x 7419		4 x 7419	

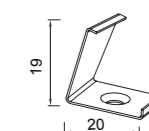
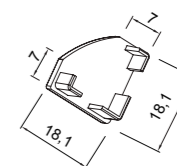
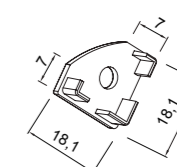
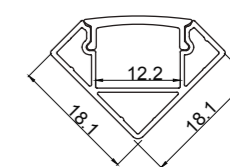
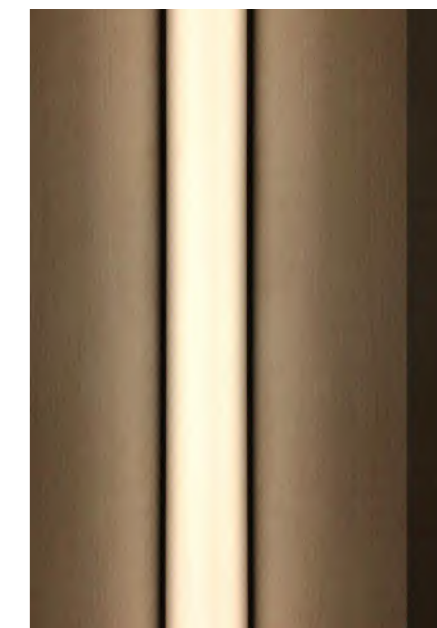

Aluminio+PCB/Aluminium+PCB

PERFILES - PROFILES

Perfil empotrable para tiras led
Recessed profile for led strips

Indoor

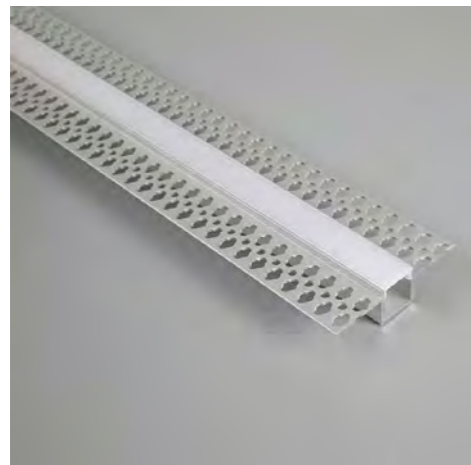

8067 Aluminio-Aluminium

Piezas incluidas/Included pieces

2 m



Perfil+difusor/Profile+diffuser

2 x 8068



2 x 8069

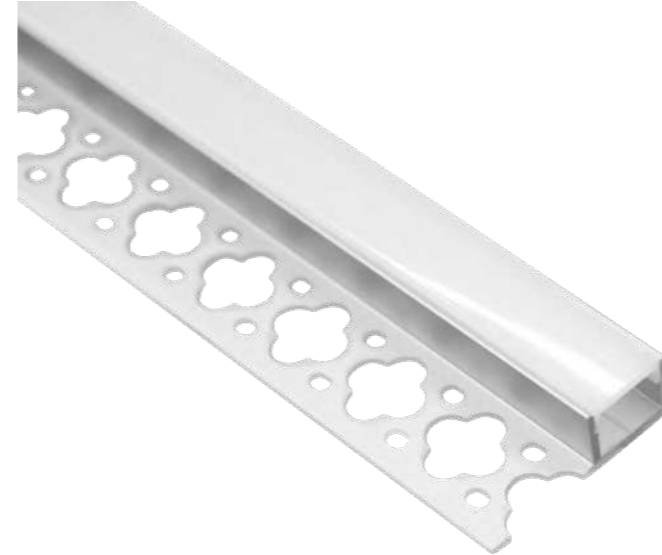
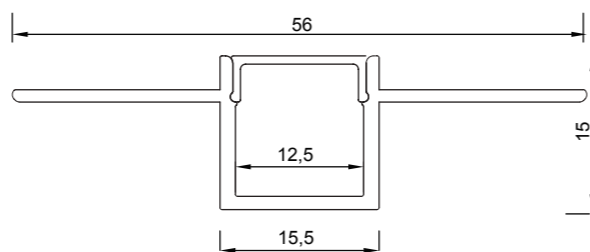
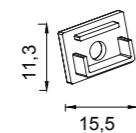
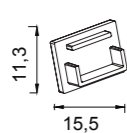

8070 Aluminio-Aluminium

Piezas incluidas/Included pieces

2 m



Perfil+difusor/Profile+diffuser

2 x 8071



2 x 8072

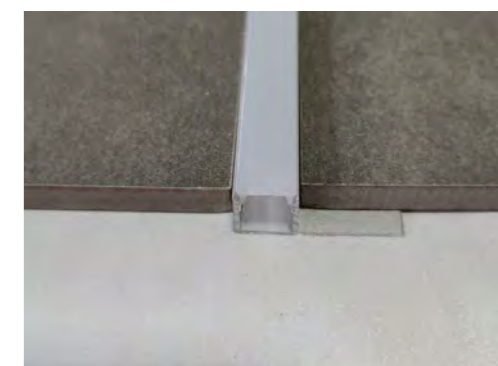
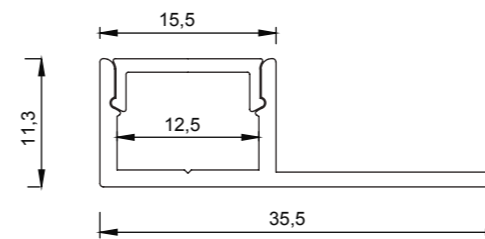
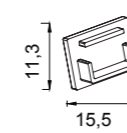
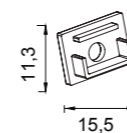

ALIMENTADORES-DRIVERS

Tension constante 24v
24v Constant voltage



Indoor

ALIMENTADORES-DRIVERS

Tension constante 24v finos
24v Constant voltage slim



7371

8293

8294

7374

7375

7376

7377

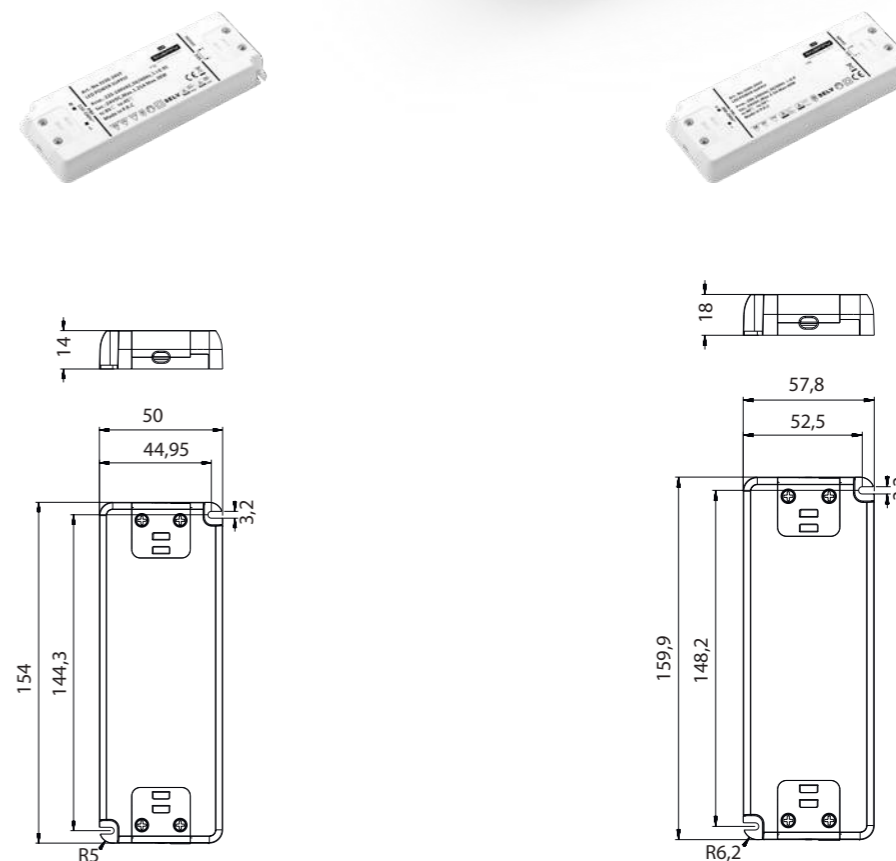
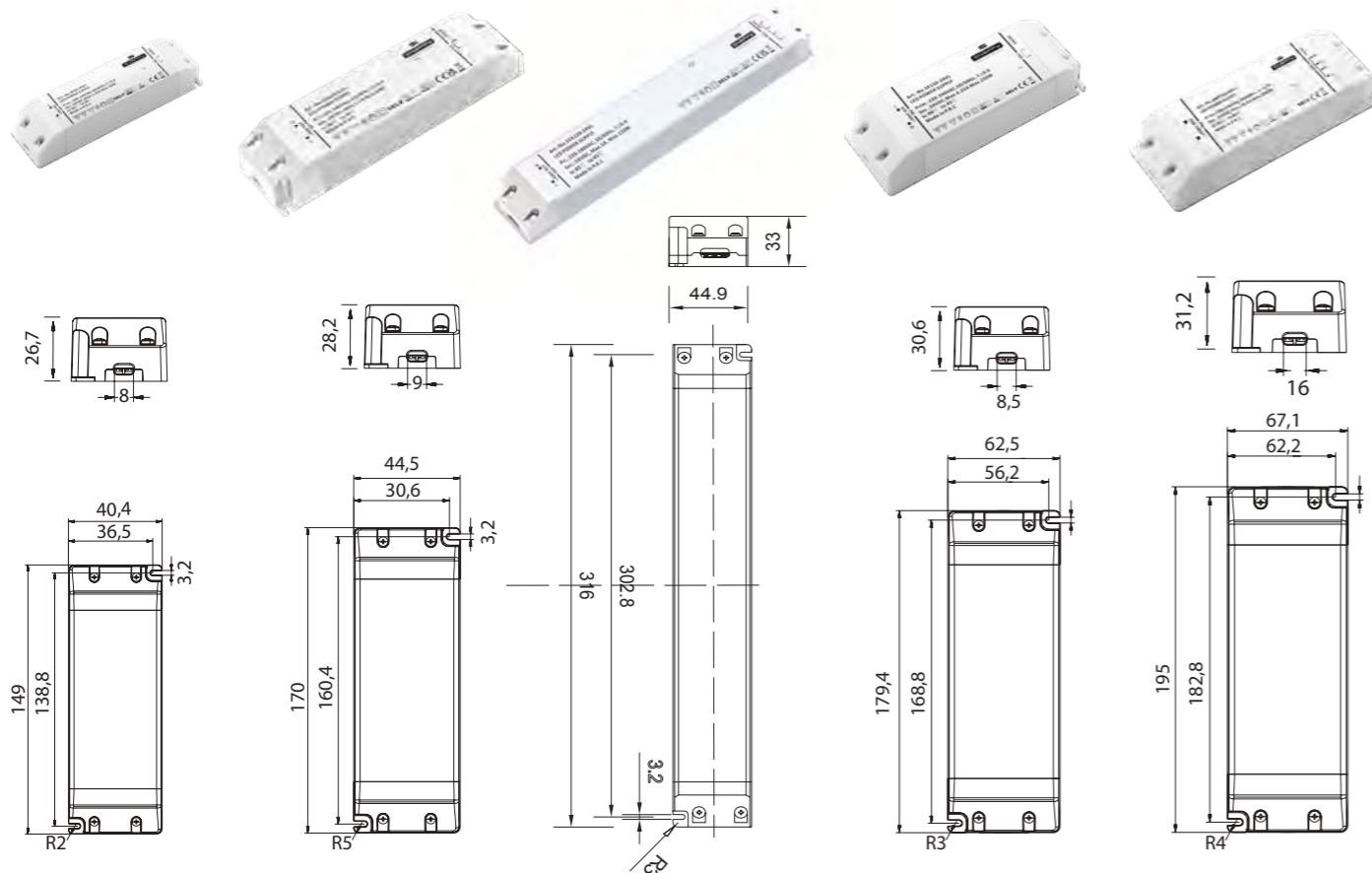

Características técnicas / Technical characteristics

Ref.	Art.-No	Tensión nominal de entrada Nominal input voltage	Rango de potencia en módulo Output power range	Tensión de salida DC Output voltage DC	Corriente de salida máxima Maximum output current	Factor de potencia Power factor	Frecuencia Frequency	Temp. máx. envolvente Max temp.at tc point	Temp. funcionamiento Operating temp.	Protección Protection
		Vac	W	Vdc	A	λ	Hz	tc (°C)	ta (°C)	IP
7371	SE30-24VL	200-240V	0-30	24	1.25	$\geq 0,9$	50/60	80°	-20...+45°	20
New	8293	SEA60-24VL	220-240V	0-60	2.5	$\geq 0,9$	50/60	90°	-20...+45°	20
New	8294	SEA120-24VL	220-240V	0-120	5	$\geq 0,9$	50/60	90°	-20...+45°	20
	7374	SE150-24VL	220-240V	0-150	6.25	$\geq 0,9$	50/60	90°	-20...+45°	20
	7375	SNP250-24VL	200-240V	0-250	10.4	$\geq 0,95$	50/60	90°	-20...+45°	20

Características técnicas / Technical characteristics

Ref.	Art.-No	Tensión nominal de entrada Nominal input voltage	Rango de potencia en módulo Output power range	Tensión de salida DC Output voltage DC	Corriente de salida máxima Maximum output current	Factor de potencia Power factor	Frecuencia Frequency	Temp. máx. envolvente Max temp.at tc point	Temp. funcionamiento Operating temp.	Protección Protection
		Vac	W	Vdc	A	λ	Hz	tc (°C)	ta (°C)	IP
7376	SS30-24VF	220-240V	0-30	24	1.25	$\geq 0,95$	50/60	85°	-20...+45°	20
7377	SS60-24VF	200-240V	0-60	24	2.5	$\geq 0,9$	50/60	80°	-20...+50°	20



SISTEMAS CONTROL-CONTROL SYSTEMS

Controlador LED DIM-TW
DIM-TW LED Controller



El controlador PRO-DIMTW-C01 permite controlar la iluminación de una tira LED monocolor o de Blanco Dinámico (TW) desde un mando a distancia.

El controlador puede ser sincronizado con hasta 8 mandos a distancia simultáneamente. Cada mando a distancia puede controlar hasta 4 controladores diferentes de manera autónoma

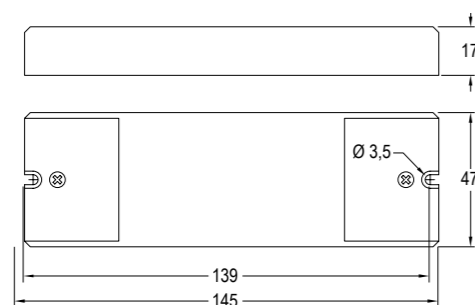

PRO-DIMTW-C01

PRO-DIMTW-C01 can control single colour (1CH) or Tunable White (2CH) LED Strips from an RF remote control.

The controller could be linked with up to 8 remotes at the same time. Each remote can control 4 controllers independently.

Accesorios / Accessories

Ref 9955911 PRO-DIM-R01



Esquema de conexión / Connection diagram

Ref.	Tensiones de entrada y salida Input-output Voltage	Tipo de regulación Control signal	Intensidad máx. de salida Max output current	Potencia máx. de salida Max output power	Tipo tira Led Led strip type	Control a través de Control made by
	V	mA	A	12V 24V		Mando a distancia RF
9955912	12-24	PWM	3 x 5A DIM 2x 5A TW	60W CH 120 W CH	Monocolor (1CH-DIM) TW (2CH)	RF Remote control

Modos de control y funcionamiento / Functions and control modes

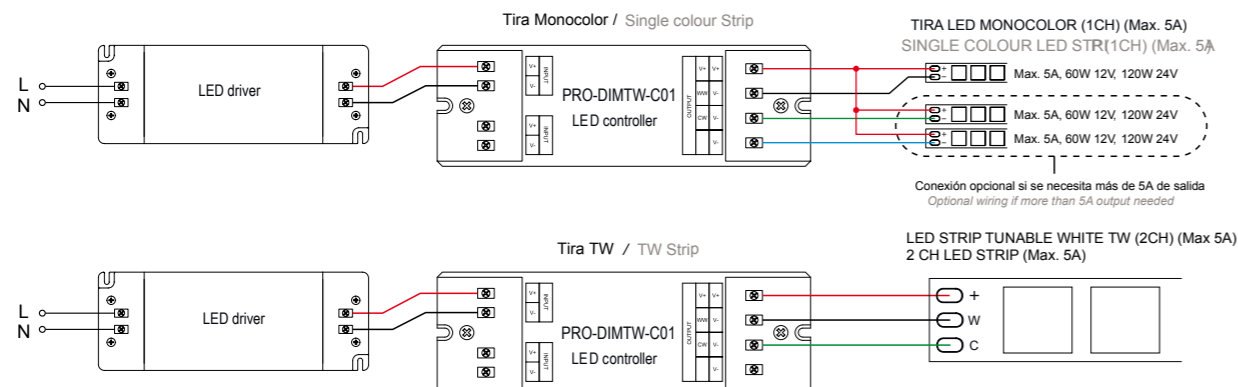

SISTEMAS CONTROL-CONTROL SYSTEMS

Mando a distancia DIM Monocolor
DIM Single Colour remote control

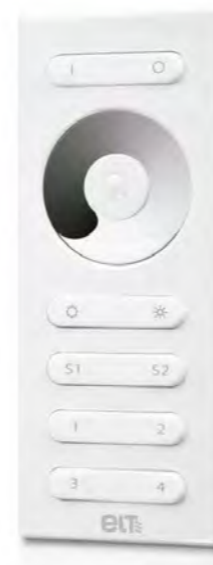

El mando PRO-DIM-R01 puede controlar hasta un máximo de 20 receptores.

Permite regular la intensidad de la luz.

Permite controlar hasta 4 zonas independientes.

Cada zona puede ser de uno o más controladores

Permite programar 2 escenas en memoria.

The PRO-DIM-R01 remote control can control a maximum of 20 receivers.

Allows regulation of lighting intensity.

Can control up to 4 independent zones.

Each zone can be with one or more controllers.

Can program 2 saving scenes.

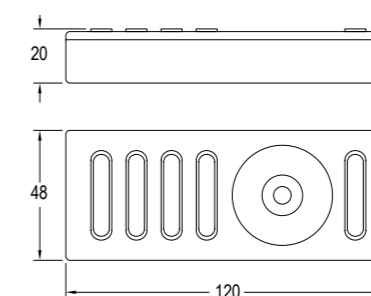

Accesorios / Accessories

Ref 9955912 PRO-DIMTW-C01



Características técnicas / Technical characteristics

Ref.	Alimentación Power	Frecuencia de operación Operation frequency	Tipo de tira LED LED strip type	Alcance máx. interior (Sin paredes) Max. Range (Without walls)	Compatible con Compatible with
		Mhz		m	
9955911	3xAAA/LR03 1,5V batteries/ pilas	434/869	TW (2CH) DIM / monocolor (1CH)	20	SPU-DIM-C01

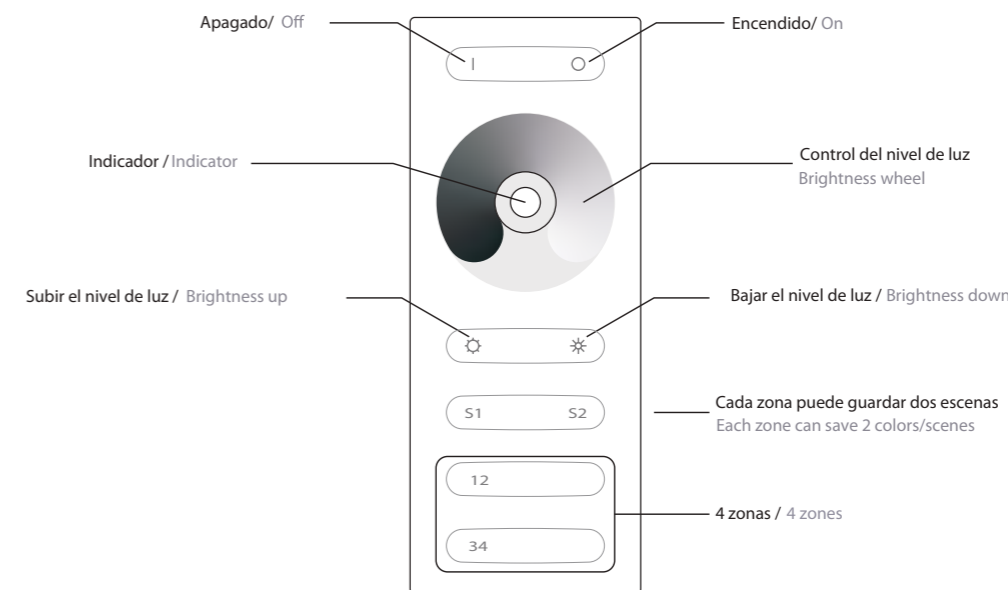

Controlador LED para pulsadores estándar y/o mando a distancia
LED Controller for standard push switch and/or remote control

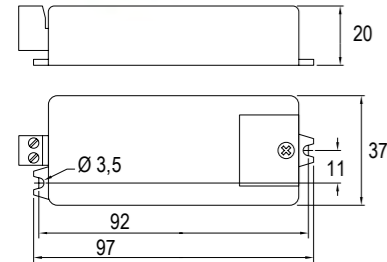

El controlador SPU-DIM-C01 permite controlar la iluminación de una tira LED monocolor desde un pulsador estándar de cualquier fabricante. Pueden controlarse las tiras LED manteniendo la misma familia de mecanismos que en el resto de la instalación en la que se integre.

También puede controlarse con los mecanismos RF SPU. Son mecanismos sin cables de instalación muy sencilla, pegar o atornillar y que funcionan con pila de 3 años de duración. Permite controlar los LEDs fijando el mecanismo en cualquier superficie.

El controlador puede ser gobernado por varios pulsadores (ver esquema de conexión) y hasta 8 mecanismos RF SPU a la vez. Puede funcionar con los dos sistemas de control de manera simultánea (pulsador conectado por cable y mecanismos RF) o sólo con uno de ellos.

STO-DIM-C01 can control single colour LED strips from a standard push switch from any manufacturer. LED strips can be controlled keeping the same kind of switches as the rest of the installation.

It can also be controlled with the RF SPU switches. These switches are wireless, work with a 3-year-life battery and are very easy to install: just screw or stick in any surface.

Controller can be managed by several push switches (see wiring diagram) and up to 8 RF SPU switches at the same time. It can work with two control systems (standard switches or RF switches) simultaneously or only with one of them.

Características técnicas / Technical characteristics

Ref.	Tensiones de entrada y salida Input-output Voltage	Tipo de regulación Control signal	Intensidad máx. de salida Max output current	Potencia máx. de salida Max output powewr	Tipo tira Led Led strip type	Control a través de Control made by
	V	mA	A	12V 24V 36V		Pulsador standard y/o mecanismo RF
9955901	12-24-36	PWM	1x8	96 W 192 W 288 W	MONOC. DIM (1CH)	Standard push switch and/or RF Switch

Modos de control y funcionamiento / Functions and control modes

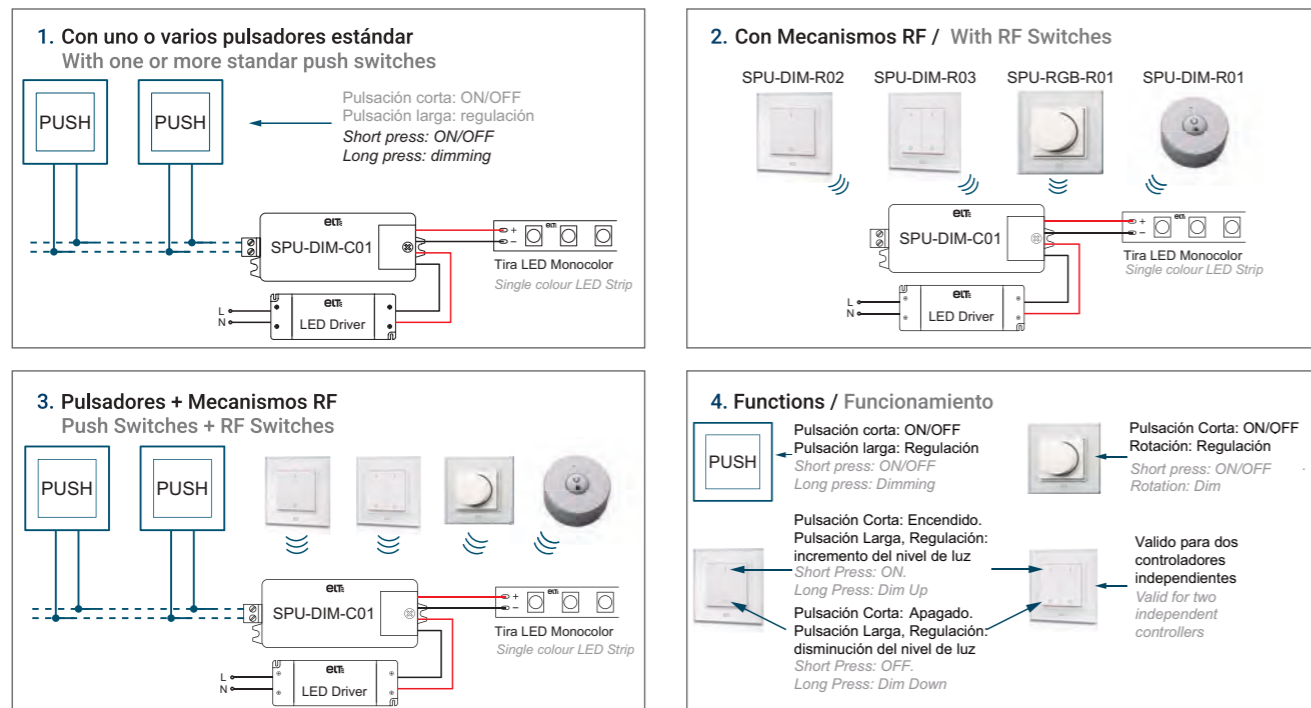

Mecanismo RF
RF Switch PUSH SYSTEM



Mecanismo RF pequeño y versátil que permite encender, apagar y regular una instalación de tira LED monocolor.

Puede ser fijado a una pared mediante tornillos o pegado (cinta de doble cara incluida). También lleva un imán para fijarse con facilidad en superficies metálicas.

Su reducido tamaño permite que pueda ser llevado en un bolsillo como mando a distancia. Está alimentado por una pila de tipo CR2025 de larga duración.

Fijación: Tornillos / iman.

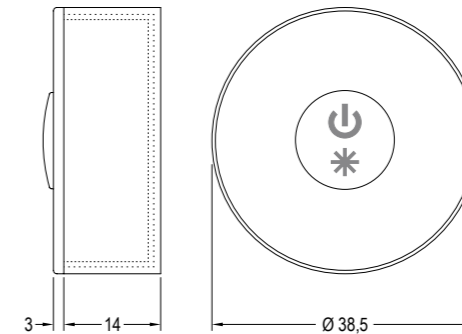

Small and versatile RF switch which allows to swithc ON/OFF and dim a single colour LED strip.

Can be easily fixed to a wall with screws or sticked (double side tape included). Also comes with a small magnet to be fixed easily on metallic surfaces.

Its small size allows to take it in a pocket as a remote control. It 's powered with a long life CR2025 battery.

Fixing: Screw / magnet.

Controlador compatible / Controller compatible with

Ref 9955901 SPU-DIM-C01



Características técnicas / Technical characteristics

Ref.	Alimentación Power	Frecuencia de operación Operation frequency	Tipo de tira LED LED strip type	Alcance máx. interior (Sin paredes) Max. Range (Without walls)	Compatible con Compatible with
		Mhz		m	
9955905	CR2025 3V battery / pila	434/869	DIM (1CH)	30	SPU-DIM-C01

Características técnicas / Technical characteristics

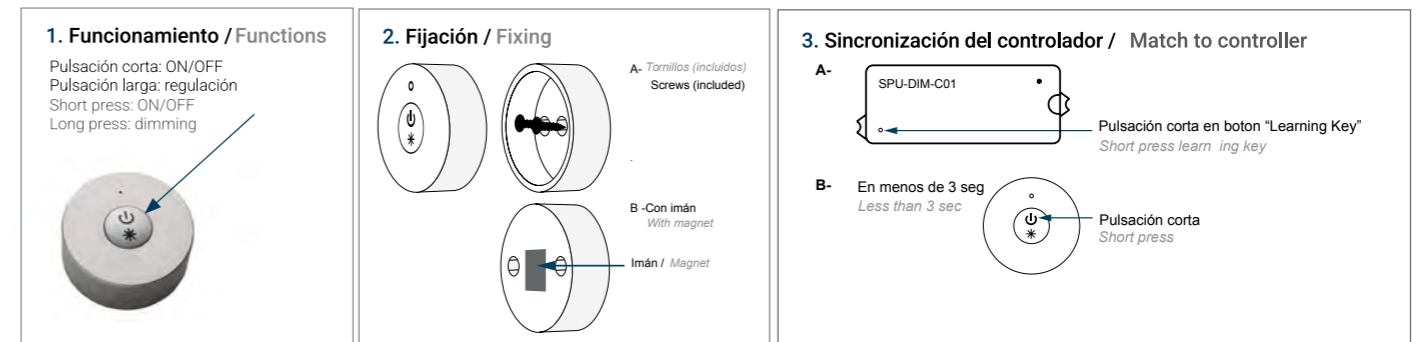

SISTEMAS CONTROL-CONTROL SYSTEMS

Digital dimmer, 1 dirección digital, 4 canales
Digital dimmer, 1 digital address, 4 channels

DAL-MULTI-C02

12-36V DC

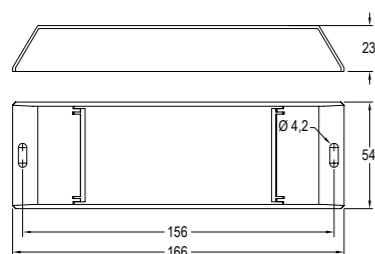

Permite la regulación de tiras LED desde cualquier sistema de control compatible con protocolo DALI. Sólo necesita conexión al bus DALI y asignar al controlador la dirección DALI desde la que se hará el control de las tiras.

Control de tiras LED monocolor.

Incluye pantalla y botones para ver y asignar fácilmente la dirección DALI.

El mismo modelo es válido para pilotar de 1 a 4 canales de forma sincronizada. Cada canal de salida tiene una capacidad de 5A.

0-100% rango de regulación según curva.

This device allows to control LED strips from any control system compatible with DALI protocol. Only needs a connexion to the DALI bus and assign the device the DALI address to control the strips.

Control of LED single colour strips.

Includes screen and buttons to see and assign easily the DALI address.

The same model works from 1 to 4 channel synchronously. Each channel has a current output of 5A

0-100% dimming range via logarithmic curve.

Características técnicas / Technical characteristics

Ref.	Tensiones de entrada y salida Input-output Voltage	Tipo de regulación Control signal	Intensidad máx. de salida Max output current	Potencia máx. de salida Max output power	Tipo tira Led Led strip type	Control a través de Tipo Control made by
	Vdc	mA	A	12V 24V 36V		
9955921	12-24-36	PWM	4 ch x 5A	240 W 480 W 720 W (4 x 60) (4 x 120) (4 x 180)	DIM	DALI

Esquema de conexión / Connection diagram

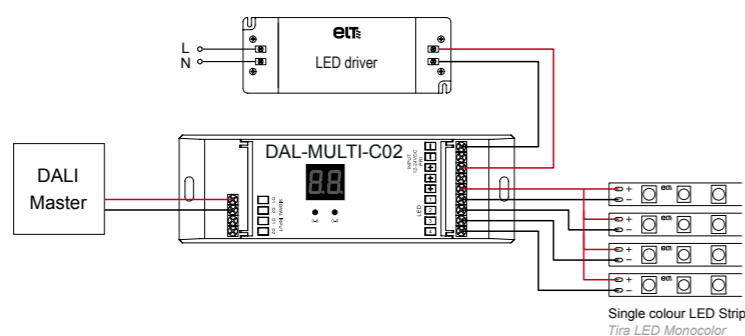

SISTEMAS CONTROL-CONTROL SYSTEMS

Controlador LED para pulsadores estándar y/o mando a distancia
LED Controller for standard push switch and/or remote control

EBLUE MULTI4

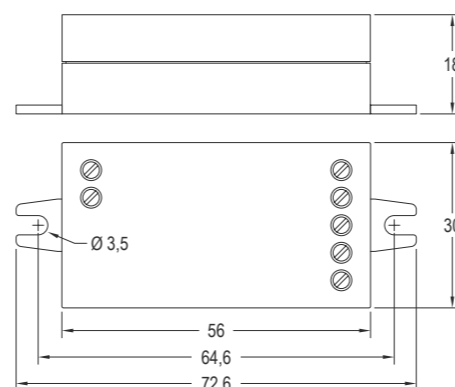

eBLUE MULTI4 es un regulador PWM de cuatro canales controlable por Bluetooth para cargas LED de tensión constante, tales como tiras y módulos LED de tensión constante.

eBLUE MULTI4 puede controlar hasta cuatro canales. La corriente de salida máxima es 6A, la cual puede ser dividida libremente entre 1-4 canales.

Dimensiones muy reducidas para su instalación.

Protegido contra sobretensiones, sobre corriente y cortocircuitos.

Controlable de forma inalámbrica a través de un dispositivo inteligente (smartphones / tablets.) Visual e intuitiva app para smartphones / tablets. Disponible gratuitamente en Apple Store / Google Play. app CASAMBI

Forma automáticamente una rápida y segura red inalámbrica de malla con otras unidades eBLUE (hasta 127 unid / red).

Permite una programación horaria de escenas. Servicio en la nube.

El firmware del dispositivo puede ser actualizado en funcionamiento de manera inalámbrica. Sección máxima en clemas 0,75-1,5 mm².

BLUE MULTI4 is a Bluetooth controllable four channel PWM dimmer for constant voltage LED loads, such as LED strips and constant voltage LED modules.

eBLUE MULTI4 can control up to four channels. The maximum combined output current 6A which can be freely divided between 1-4 CH.

Very small size for easy installation.

Protected against overvoltage, overcurrent and short circuit situations.

Wirelessly controllable with a smart device (smartphone, tablet.) Intuitive and visual app for smartphones / tablets. Available for free on Apple Store / Google Play. CASAMBI

Forms automatically a fast and secure wireless mesh network with other eBLUE devices (up to 127 units / network).

Use timers to turn on and off scene at predefined times.

Cloud service that enhances user experience. Device firmware can be updated over the air. Max terminal section 0.75-1.5 mm²

Características técnicas / Technical characteristics

Ref.	Tensiones de entrada y salida Input-output Voltage	Tipo de regulación Control signal	Intensidad máx. de salida Max output current	Potencia máx. de salida Max output power	Temp. máx. envoltorio Max. temp at tc point	Temp. funcionamiento Operatin temp.	Control a través de Tipo Control made by
	Vdc	mA	A	12V 24V	tc (°)	ta (°)	
9953074	12-24	PWM	6	72 W 144 W	+75	-20...+45	DIM, TW, RGB, RGBW

Esquema de conexión / Connection diagram

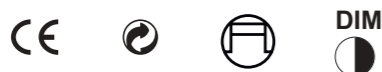
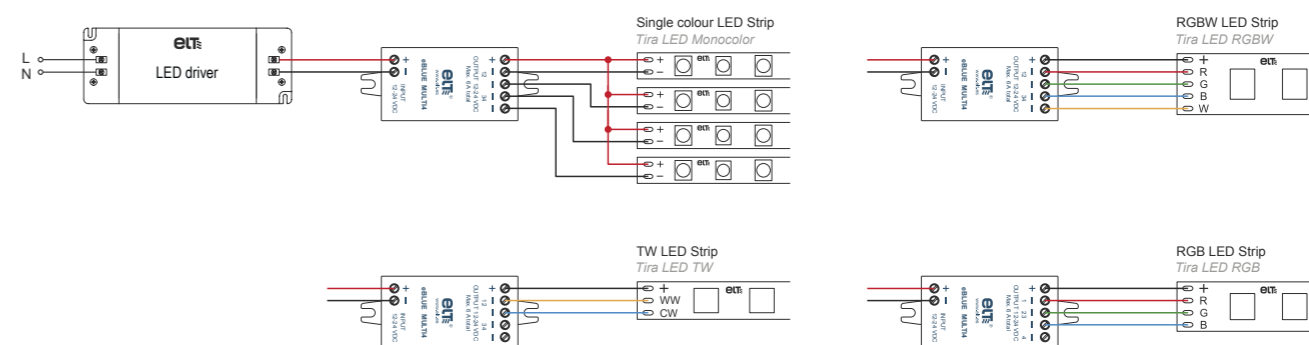

SKYLINE KIT

New

Indoor

REFERENCE	SIZE	FINISH
8460	5M ROLL	Negro mate-Matt black
		Aluminio-Aluminium

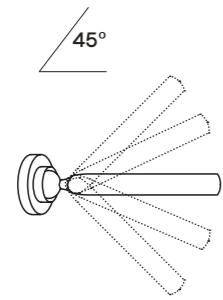
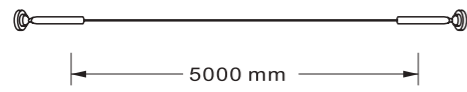

MODO DE USO 

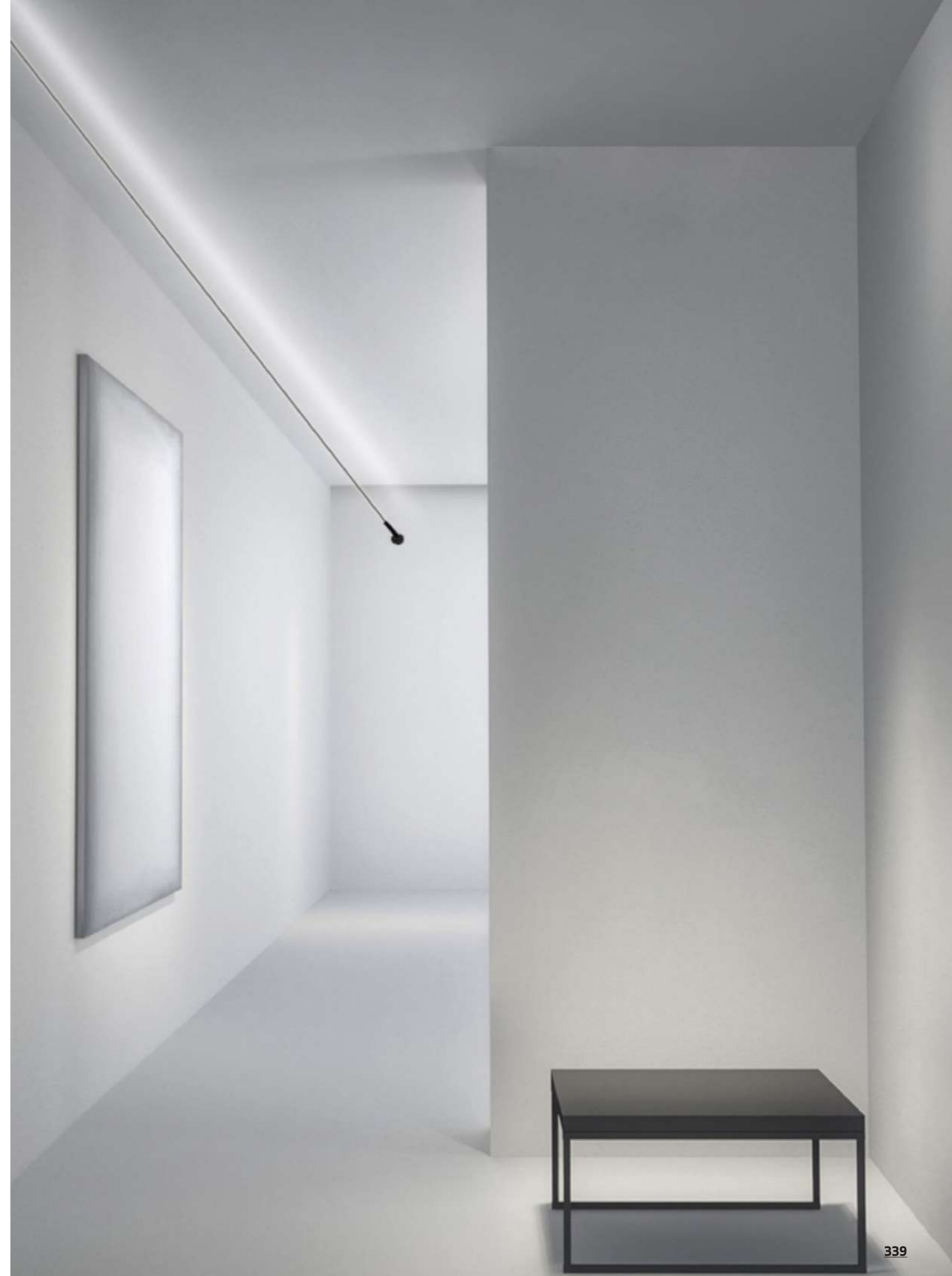

URANO 150W 4000K

Campanas Led
Ufo bays Led

Indoor

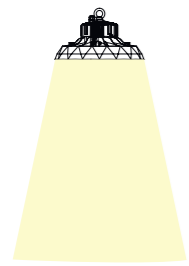

7420 60°

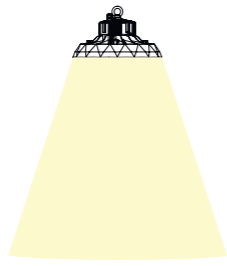

7421 90°

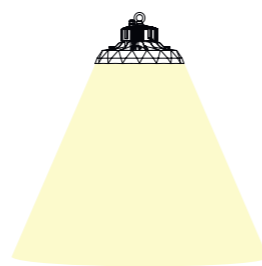

7422 120°

Luminous Intensity Distribution Curve

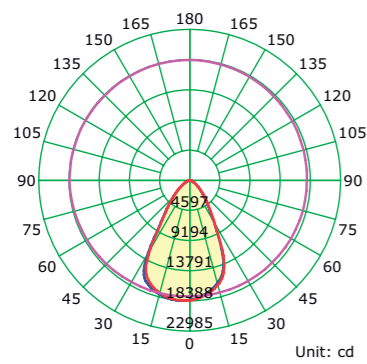

Unit: cd

Average Diffuse Angle(50%): 60.4°

— C0-C180 — C90-C270 — G6

Illuminance at a Distance

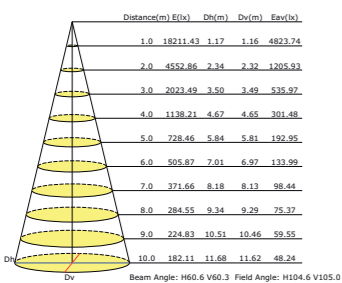

Luminous Intensity Distribution Curve

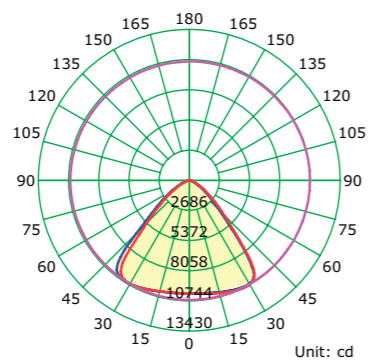

Unit: cd

Average Diffuse Angle(50%): 88.4°

— C0-C180 — C90-C270 — G28

Illuminance at a Distance

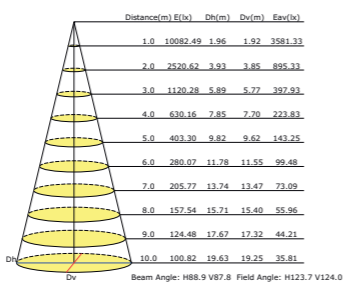

Luminous Intensity Distribution Curve

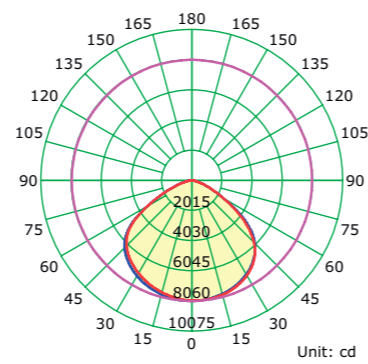

Unit: cd

Average Diffuse Angle(50%): 112.0°

— C0-C180 — C90-C270 — G0

Illuminance at a Distance

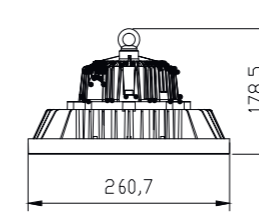
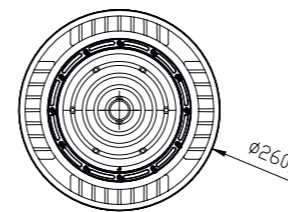
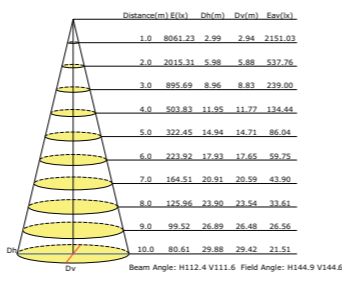

REFERENCE	K	LED WATT	BEAM ANGLE	LUMENS	FINISH
7420	4000K	150W	60°	21000lm	Negro-Black
7421	4000K	150W	90°	21000lm	Negro-Black
7422	4000K	150W	120°	21000lm	Negro-Black
180-260V~ 50/60Hz CRI≥ 80					Aluminio-Aluminium



URANO 150W 5000K

Campanas Led
Ufo bays Led

Indoor

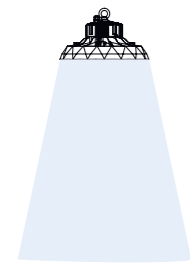

7423 60°

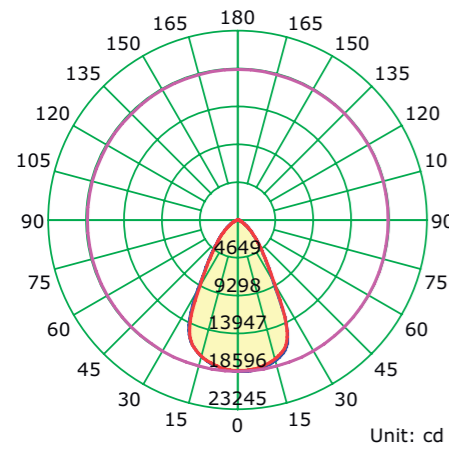

Illuminance at a Distance

Distance(m)	E(lx)	Dh(m)	Dv(m)	Eav(lx)
1.0	18575.60	1.15	1.15	4836.52
2.0	4643.90	2.31	2.31	1209.13
3.0	2063.96	3.46	3.46	537.39
4.0	1166.97	4.62	4.61	302.28
5.0	743.02	5.77	5.76	193.46
6.0	515.99	6.93	6.92	134.35
7.0	379.09	8.08	8.07	98.70
8.0	290.24	9.24	9.22	75.57
9.0	229.33	10.39	10.37	59.71
10.0	185.76	11.55	11.53	48.37

Beam Angle: H60.0 V59.9 Field Angle: H104.9 V104.9

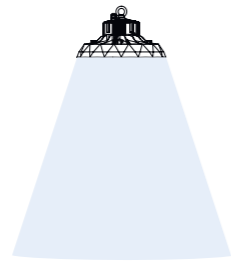

7424 90°

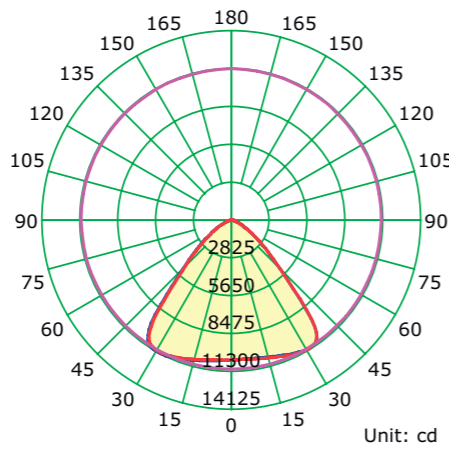

Illuminance at a Distance

Distance(m)	E(lx)	Dh(m)	Dv(m)	Eav(lx)
1.0	10446.65	1.93	1.91	3738.49
2.0	2611.66	3.86	3.82	934.62
3.0	1160.74	5.78	5.74	415.39
4.0	652.92	7.71	7.65	233.66
5.0	417.87	9.64	9.56	149.54
6.0	290.18	11.57	11.47	103.85
7.0	213.20	13.49	13.38	76.30
8.0	163.23	15.42	15.29	58.41
9.0	128.97	17.35	17.21	46.15
10.0	104.47	19.28	19.12	37.38

Beam Angle: H87.9 V87.4 Field Angle: H124.4 V123.5

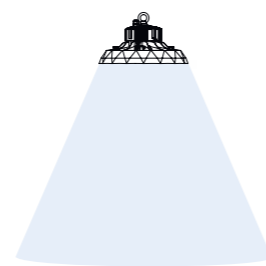

7425 120°

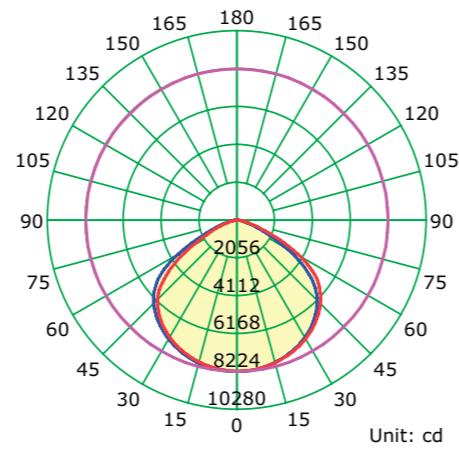

Illuminance at a Distance

Distance(m)	E(lx)	Dh(m)	Dv(m)	Eav(lx)
1.0	8223.57	3.15	3.14	2207.84
2.0	2055.89	6.29	6.28	551.96
3.0	913.73	9.44	9.42	245.32
4.0	513.97	12.59	12.56	137.99
5.0	328.94	15.74	15.69	88.31
6.0	228.43	18.88	18.83	61.33
7.0	167.83	22.03	21.97	45.06
8.0	128.49	25.18	25.11	34.50
9.0	101.53	28.32	28.25	27.26
10.0	82.24	31.47	31.39	22.08

Beam Angle: H115.1 V115.0 Field Angle: H145.5 V145.4

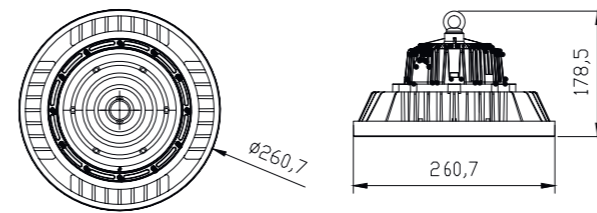

REFERENCE	K	LED WATT	BEAM ANGLE	LUMENS	FINISH
7423	5000K	150W	60°	22500lm	Negro-Black
7424	5000K	150W	90°	22500lm	Negro-Black
7425	5000K	150W	120°	22500lm	Negro-Black
180-260V~ 50/60Hz CRI≥ 80					Aluminio-Aluminium



URANO 200W 4000K

Campanas Led
Ufo bays Led

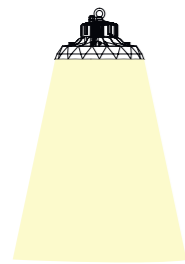

7426 60°

Luminous Intensity Distribution Curve

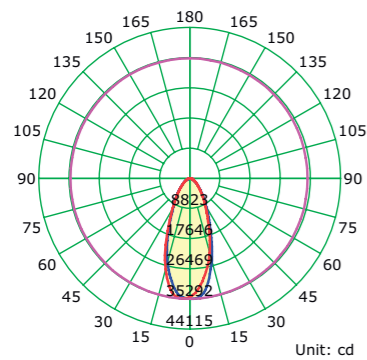

Unit: cd

Average Diffuse Angle(50%): 42.0°

— C0-C180 — C90-C270 — G1

Iluminance at a Distance

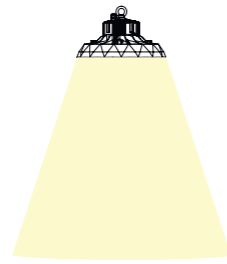
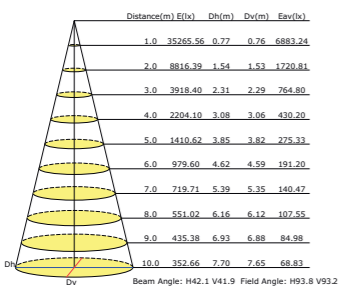

7427 90°

Luminous Intensity Distribution Curve

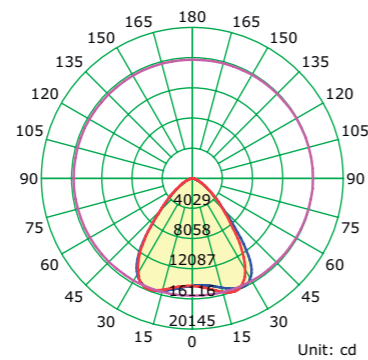

Unit: cd

Average Diffuse Angle(50%): 82.8°

— C0-C180 — C90-C270 — G20

Iluminance at a Distance

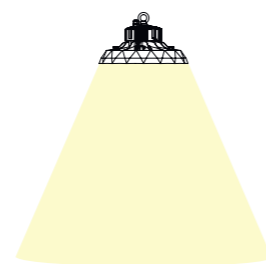
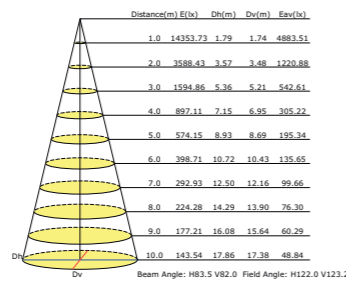

7428 120°

Luminous Intensity Distribution Curve

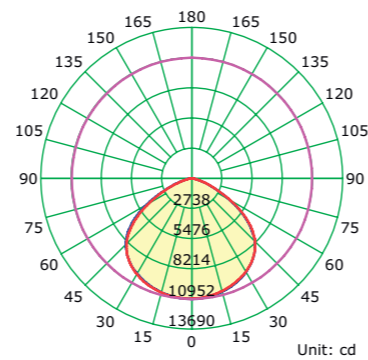

Unit: cd

Average Diffuse Angle(50%): 112.9°

— C0-C180 — C90-C270 — G0

Iluminance at a Distance

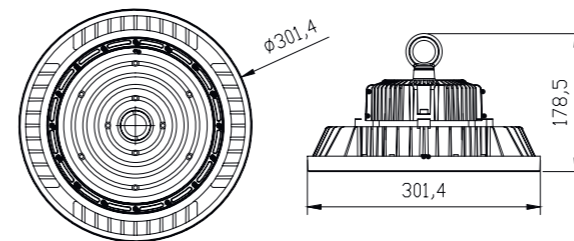
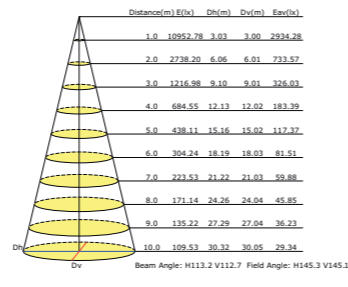

REFERENCE	K	LED WATT	BEAM ANGLE	LUMENS	FINISH
7426	4000K	200W	60°	28000lm	Negro-Black
7427	4000K	200W	90°	28000lm	Negro-Black
7428	4000K	200W	120°	28000lm	Negro-Black
180-260V~ 50/60Hz CRI≥ 80					Aluminio-Aluminium



URANO 200W 5000K

Campanas Led
Ufo bays Led

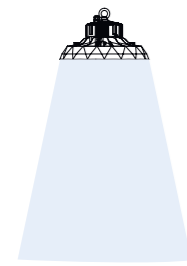

7429 60°

Luminous Intensity Distribution Curve

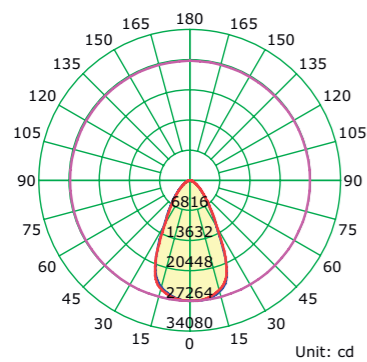

Unit: cd

Average Diffuse Angle(50%): 56.8°

— C0-C180 — C90-C270 — G5

Illuminance at a Distance

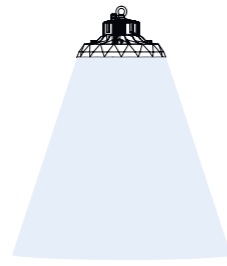
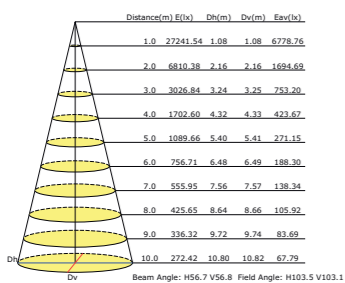

7430 90°

Luminous Intensity Distribution Curve

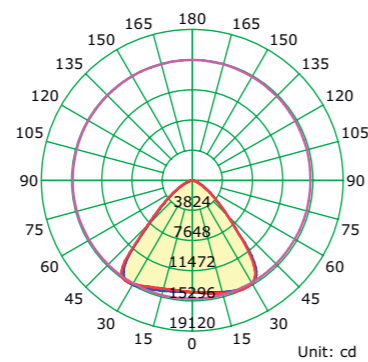

Unit: cd

Average Diffuse Angle(50%): 88.1°

— C0-C180 — C90-C270 — G31

Illuminance at a Distance

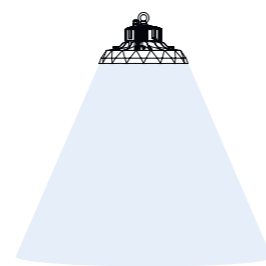
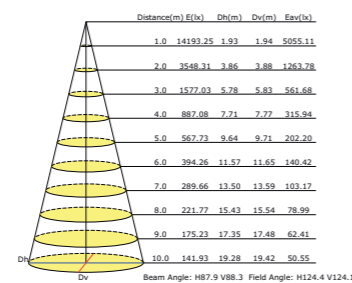

7431 120°

Luminous Intensity Distribution Curve

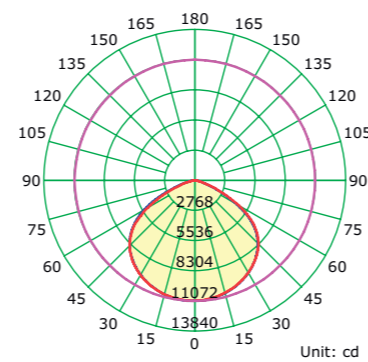

Unit: cd

Average Diffuse Angle(50%): 116.1°

— C0-C180 — C90-C270 — G1

Illuminance at a Distance

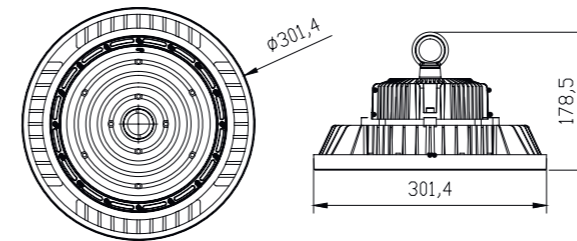
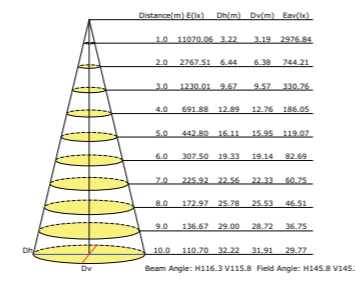

REFERENCE	K	LED WATT	BEAM ANGLE	LUMENS	FINISH
7429	5000K	200W	60°	30000lm	Negro-Black
7430	5000K	200W	90°	30000lm	Negro-Black
7431	5000K	200W	120°	30000lm	Negro-Black
					Aluminio-Aluminium
180-260V~ 50/60Hz CRI≥ 80					



Apliques exterior

Outdoor wall lights



REFERENCE	K	LED WATT	LUMENS	FINISH
8152	3000K	6W	550lm	Blanco-White
8153	3000K	6W	550lm	Gris Oscuro-Dark grey
8154	3000K	6W	550lm	Negro-Black
220-240V~ 50/60Hz CRI ≥80				Aluminio-Aluminium

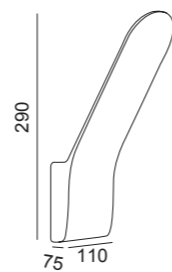
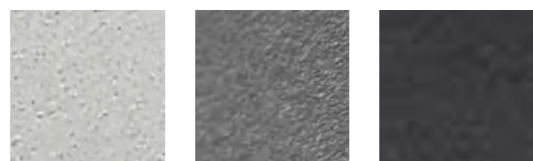

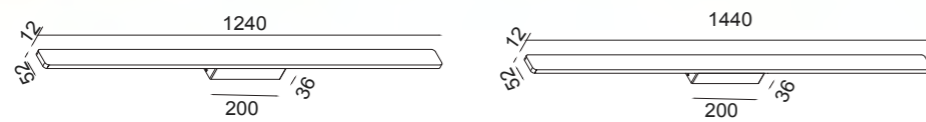

REFERENCE	K	LED WATT	LUMENS	FINISH
7990	3000K	20W	1900lm	Blanco-White
7991	3000K	20W	1900lm	Gris Oscuro-Dark grey
7992	3000K	20W	1900lm	Negro-Black
7993	3000K	20W	1900lm	Corten-Corten
7994	3000K	24W	2300lm	Blanco-White
7995	3000K	24W	2300lm	Gris Oscuro-Dark grey
7996	3000K	24W	2300lm	Negro-Black
7997	3000K	24W	2300lm	Corten-Corten
220-240V - 50/60Hz CRI ≥80				Aluminio-Aluminium

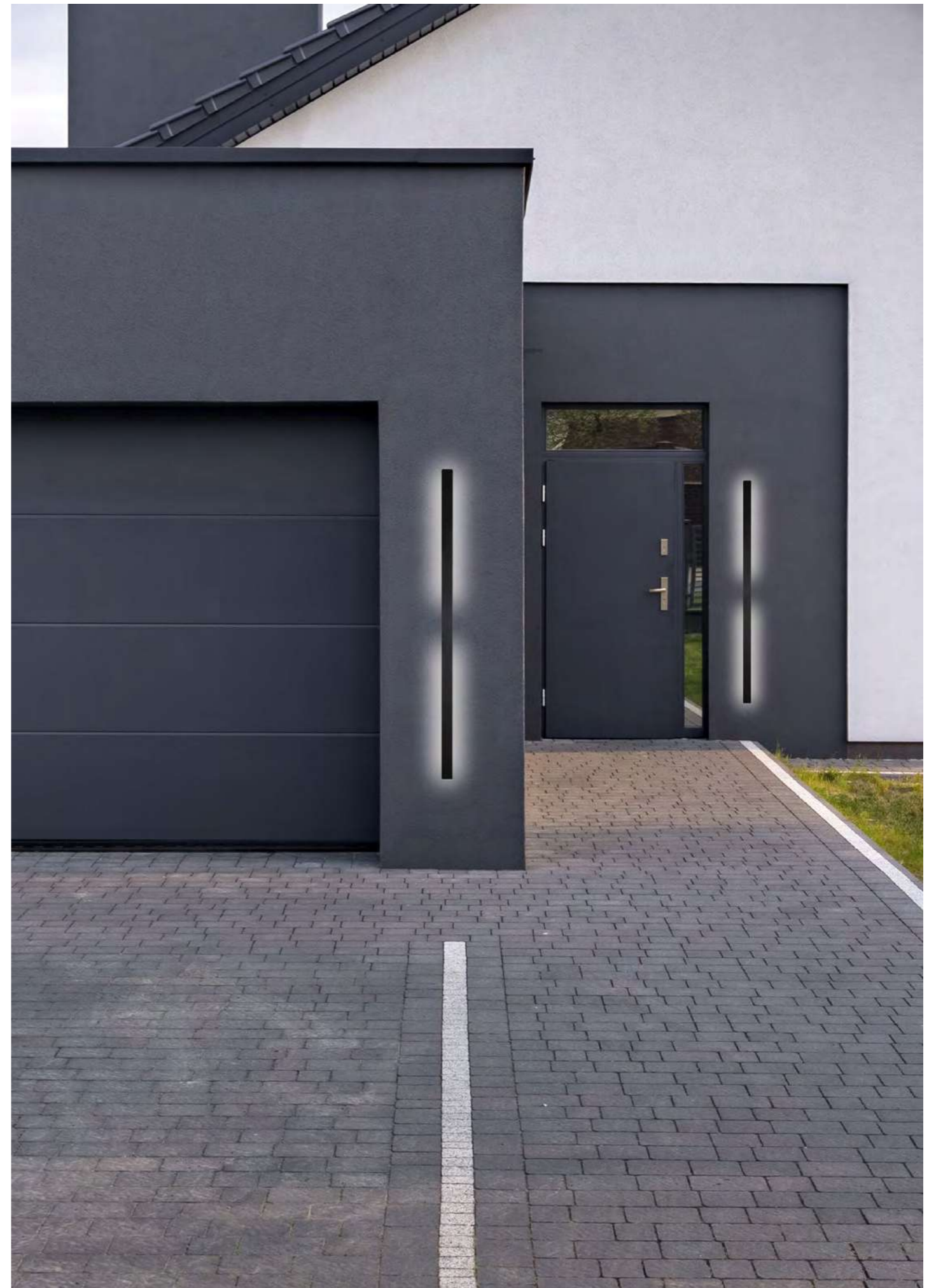
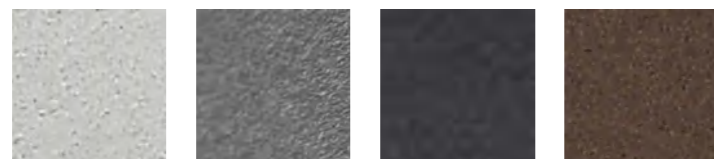

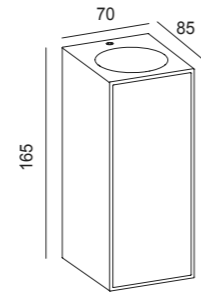

REFERENCE	BULB (No incl)	FINISH
7929	2L x GU10	Gris Oscuro/madera-Dark Grey/wood
máx. 10W LED (No incl)	100-240V~ 50/60Hz	Aluminio/Cristal/Madera-Aluminium/Glass/SPC Wood



REFERENCE	BULB NO INCLUDED	FINISH
7928	1L x E27	Gris Oscuro/madera-Dark Grey/wood
máx. 15W LED (No incl)	100-240V~ 50/60Hz	Aluminio/PC/Madera-Aluminium/Opal PC/SPC Wood

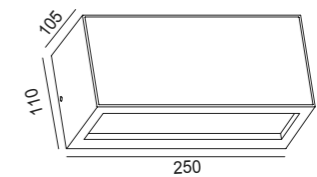

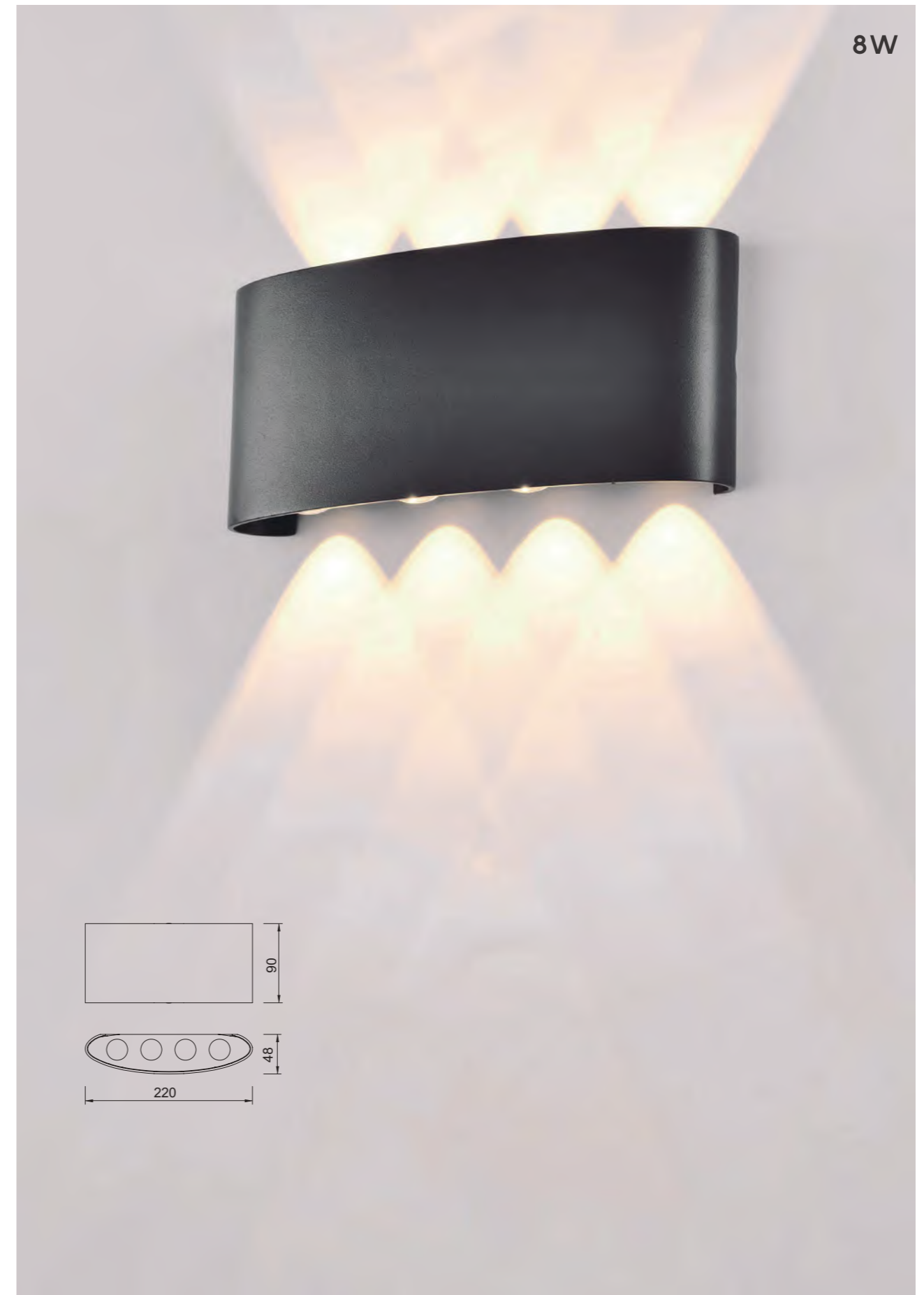

REFERENCE	K	LED WATT	LUMENS	FINISH
6540	3000K	6W	620lm	Gris oscuro-Dark grey
6541	3000K	6W	620lm	Arena blanco-Sand white
7813	3000K	8W	830lm	Gris oscuro-Dark grey
7814	3000K	8W	830lm	Arena blanco-Sand white
		220-240V ~ 50/60Hz	Aluminio cristal-Aluminium glass	





REFERENCE	BULB NO INCLUDED	FINISH
7133	1L x E27	Beige oscuro-Dark beige
	máx. 20W LED (No incl)	100-240V~ 50/60Hz
Aluminio/fibra textil sintética-Aluminium/synthetic textile fibre		

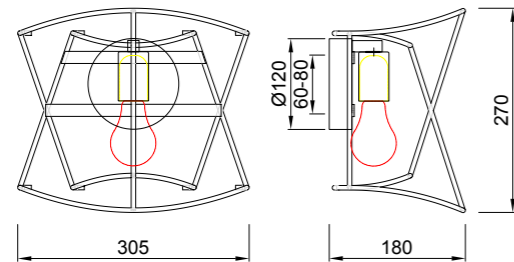

7131
pág. 430



MAYA

by José Ignacio Ballester

Appliques exterior-Outdoor wall lights

Outdoor

OAMI 005818614-0005



REFERENCE	BULB NO INCLUDED	FINISH
6551	1L x E27	Gris oscuro-Dark grey
6552	1L x E27	Gris oscuro-Dark grey
máx. 20W LED (No incl)		100-240V~ 50/60Hz Aluminio/cristal-Aluminium/glass



6550 pág. 460 6555 pág. 438 6553 pág. 416

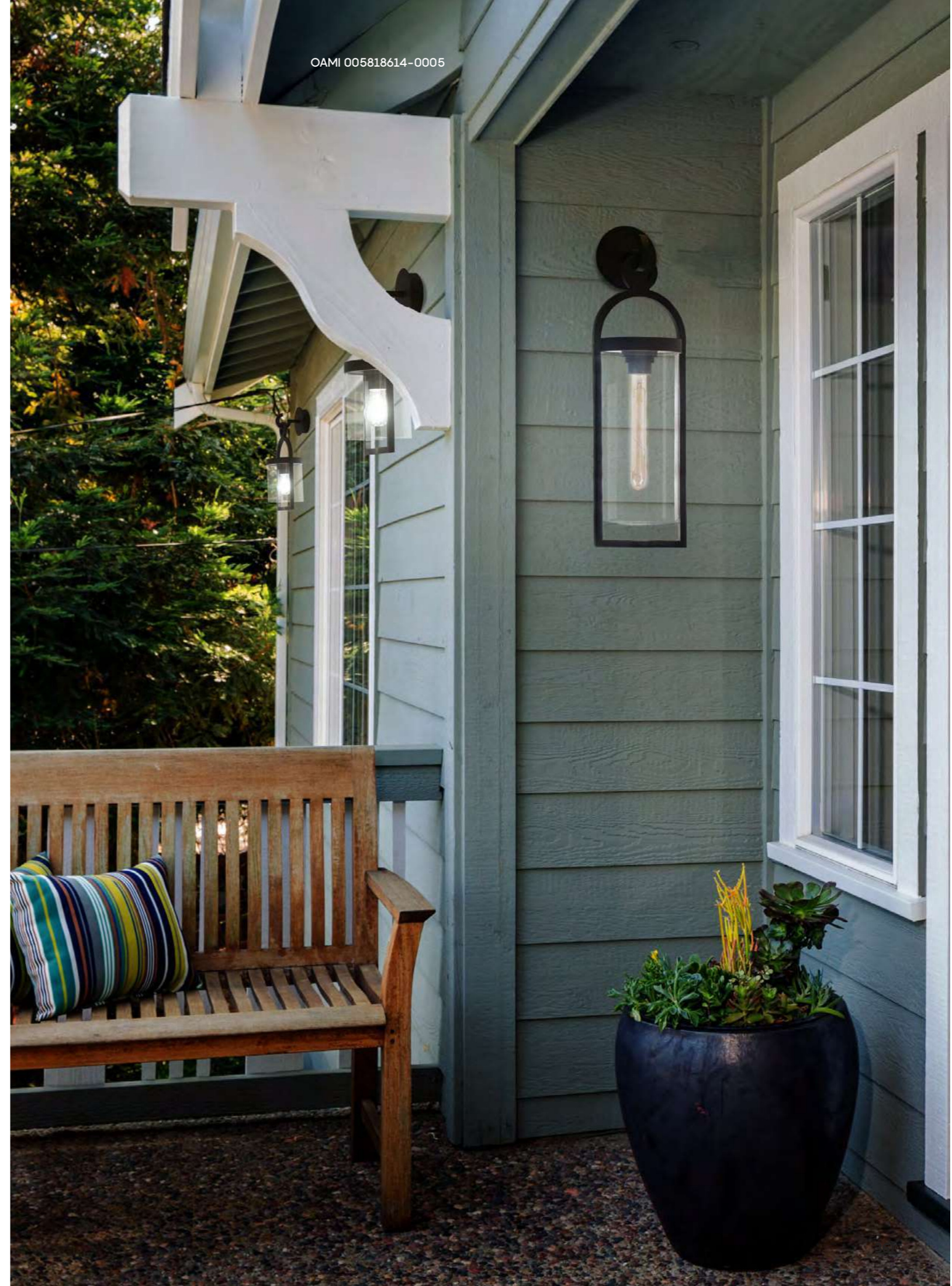



REFERENCE	K	LED WATT	LUMENS	FINISH	SENSOR	IP
6774	3000K	15W	1120lm	Gris Oscuro/Madera-Dark Grey/Wood	*	54
6770	3000K	13W	980lm	Gris Oscuro/Madera-Dark Grey/Wood		65
				Aluminio/PC-Aluminium/PC		

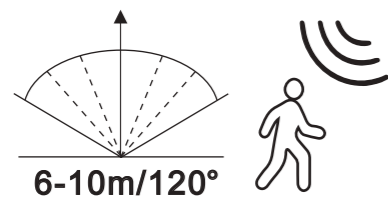
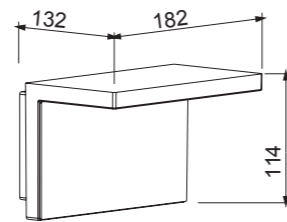
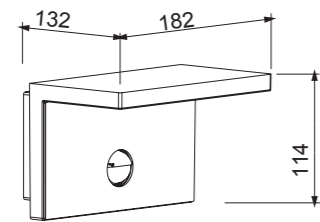

6771
pág. 464





6495

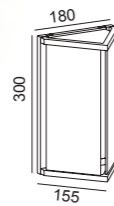

6494

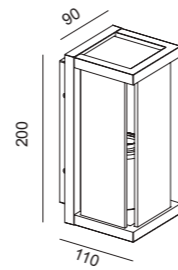

REFERENCE	BULB NO INCLUDED	FINISH
6495	1L x E27	Grafito-Graphite
6494	1L x E27	Grafito-Graphite
máx. 20W LED (No incl)		100-240V~ 50/60Hz Aluminio/cristal-Aluminium/glass



7086 pág. 394 7085 pág. 456 6490 pág. 458



6495



6492

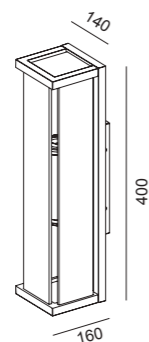

6493

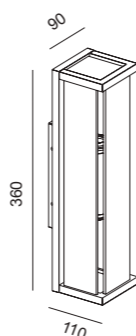

REFERENCE	BULB NO INCLUDED	FINISH
6492	2L x E27	Grafito-Graphite
6493	2L x E27	Grafito-Graphite
máx. 20W LED (No incl)		100-240V~ 50/60Hz Aluminio/cristal-Aluminium/glass

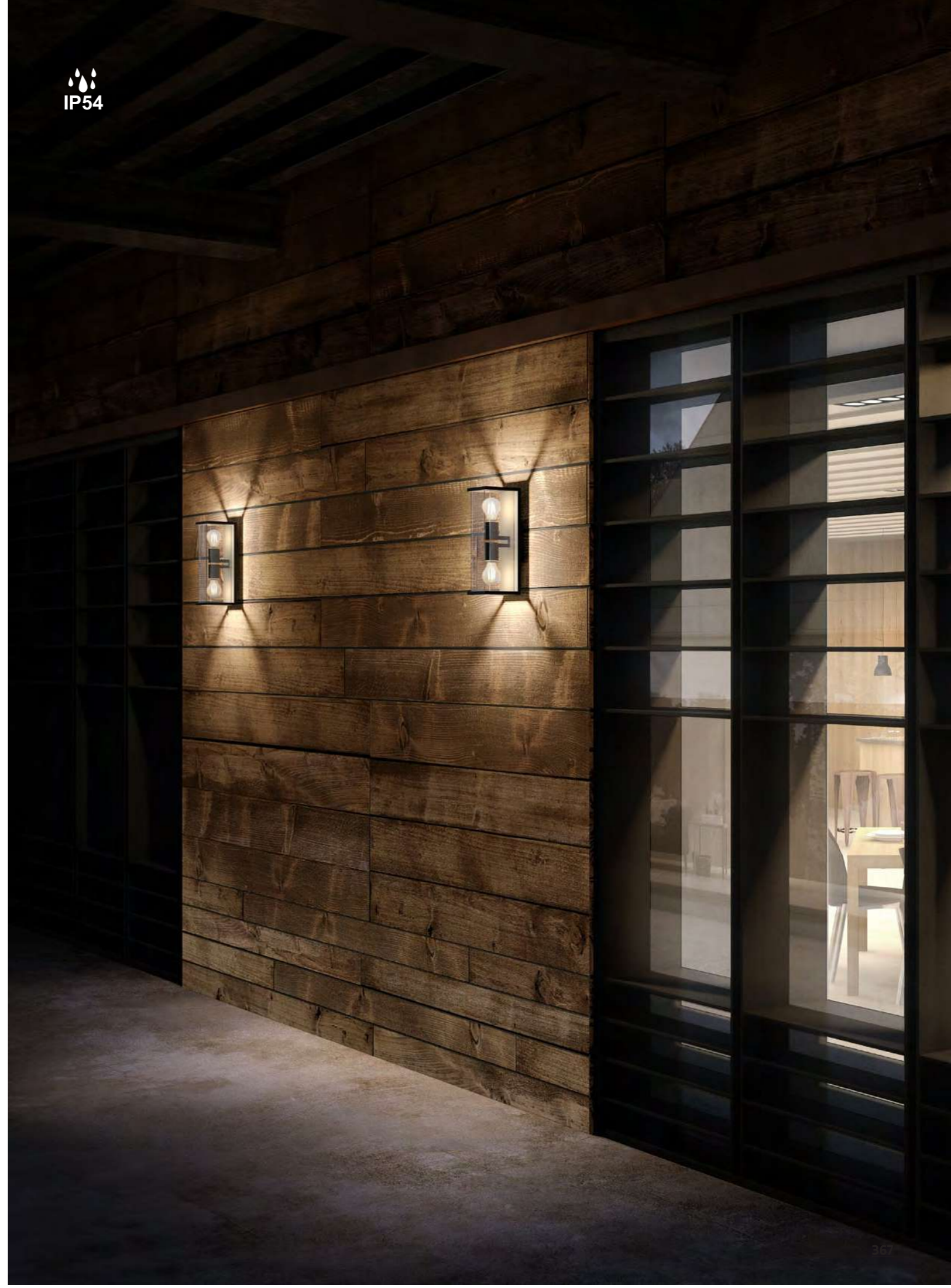

TEJA

by Santolaria & Lluscà

Outdoor



REFERENCE	BULB NO INCLUDED	FINISH
6508	1L x E27	Blanco-White
	máx. 20W LED (No incl)	100-240V ~ 50/60Hz Polietileno-Polyethylene

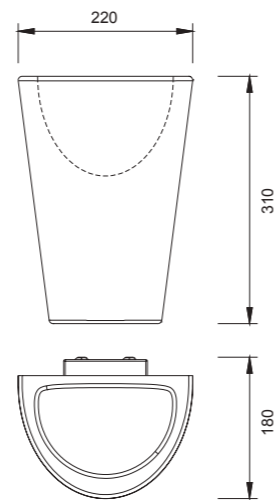

VOLCANO

Apliques exterior-Outdoor wall lights

Outdoor

IP65

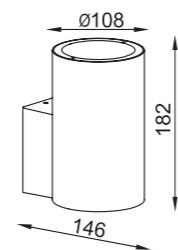
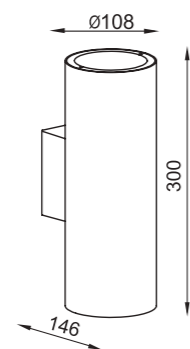

REFERENCE	BULB NO INCLUDED	FINISH
6482	2L x E27	Grafito-Graphite
6483	1L x E27	Grafito-Graphite
máx. 20W LED (No incl)		100-240V~ 50/60Hz Aluminio/cristal-Aluminium/glass



7908
pág. 414



IGUAZÚ

by José Ignacio Ballester

Apliques exterior-Outdoor wall lights

Outdoor



REFERENCE	BULB (No incl)	FINISH
6558	1L x GX53	Gris oscuro-Dark grey
6559	1L x GX53	Blanco-White
OAMI 005818614-0003	máx. 10W LED (No incl)	100-240V ~50/60Hz Aluminio-Aluminium

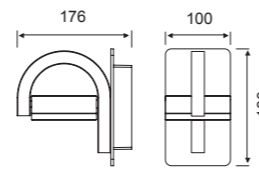

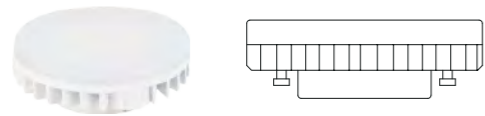

IP54

OAMI 005818614-0003



Bombillas recomendadas-Suggested bulbs

REFERENCE	Wattios LED	CCT	Lumens	Ángulo luz
 R09224	9W	3000K	730lm	120°
 R09225	9W	4000K	740lm	120°

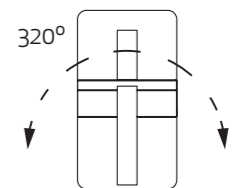

Luz orientable-Orientable light



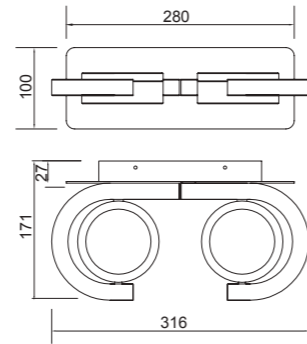
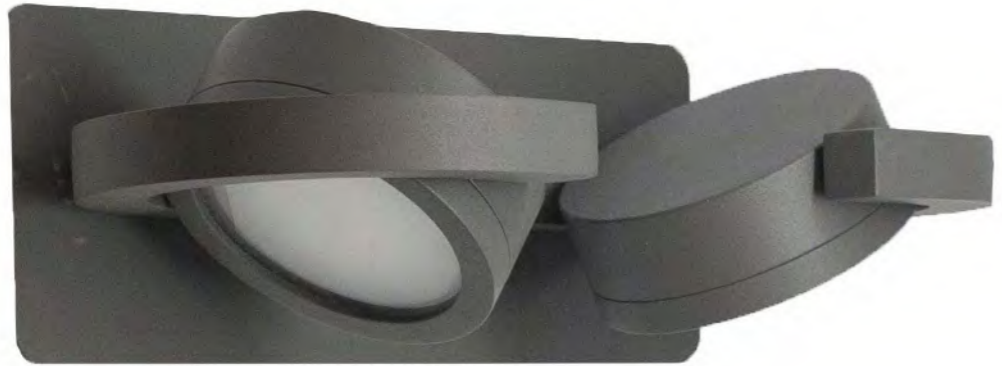

REFERENCE	BULB (No incl)	FINISH
6769	2L x GX53	Gris oscuro-Dark grey
6768	2L x GX53	Blanco-White
máx. 10W LED (No incl)		100-240V~50/60Hz Aluminio-Aluminium



IP54

OAMI 005818614-0003

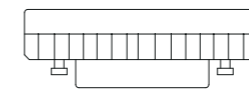

Bombillas recomendadas-Suggested bulbs

REFERENCE	Wattios LED	CCT	Lumens	Ángulo luz
R09224	9W	3000K	730lm	120°
R09225	9W	4000K	740lm	120°

KANDANCHÚ

Apliques exterior-Outdoor wall lights

Outdoor

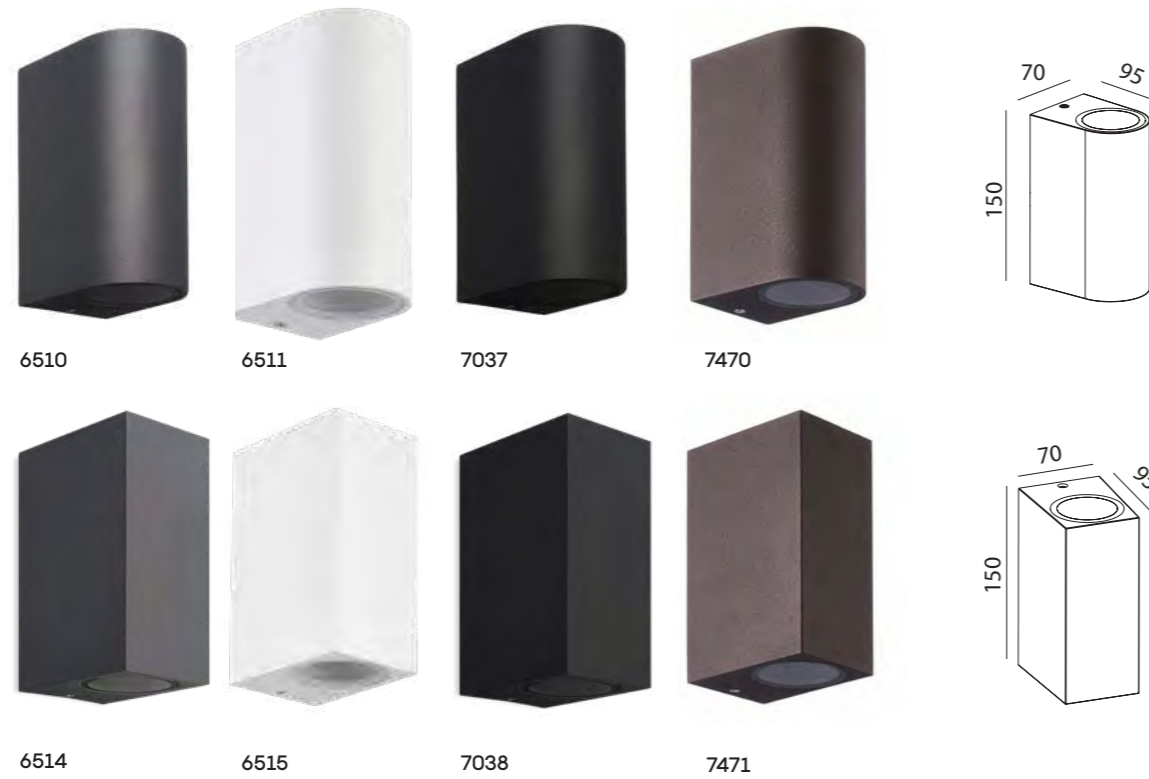

REFERENCE	BULB (No incl)	FINISH
6510	2L x GU10	Gris oscuro-Dark grey
6511	2L x GU10	Blanco-White
7037	2L x GU10	Negro-Black
7470	2L x GU10	Corten-Corten
6514	2L x GU10	Gris oscuro-Dark grey
6515	2L x GU10	Blanco-White
7038	2L x GU10	Negro-Black
7471	2L x GU10	Corten-Corten
máx. 10W LED (No incl)		100-240V~50/60Hz Aluminio/Cristal-Aluminium/Glass

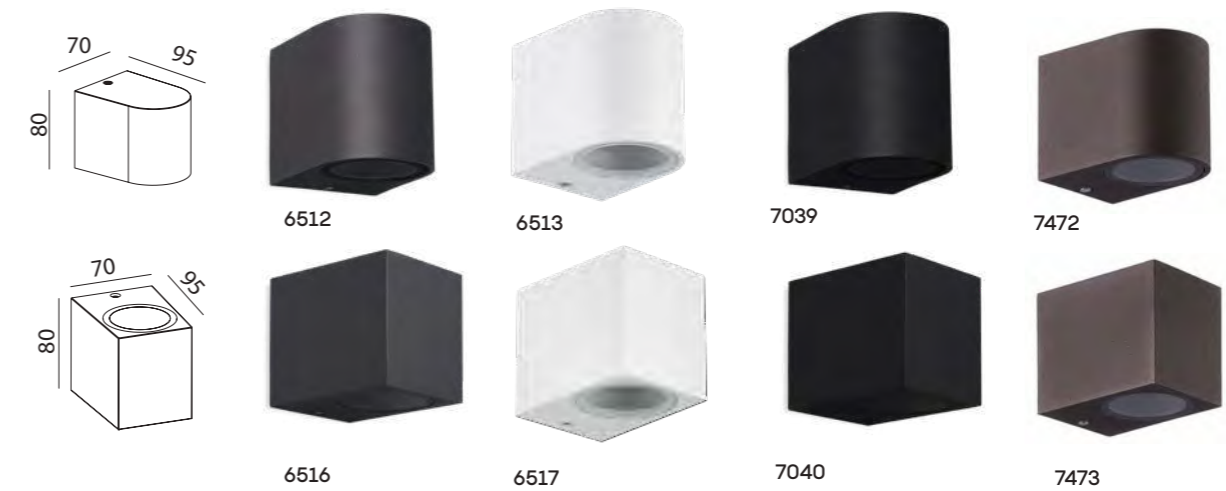

REFERENCE	BULB (No incl)	FINISH
6512	1L x GU10	Gris oscuro-Dark grey
6513	1L x GU10	Blanco-White
7039	1L x GU10	Negro-Black
7472	1L x GU10	Corten-Corten
6516	1L x GU10	Gris oscuro-Dark grey
6517	1L x GU10	Blanco-White
7040	1L x GU10	Negro-Black
7473	1L x GU10	Corten-Corten
máx. 10W LED (No incl)		100-240V - 50/60Hz Aluminio/Cristal-Aluminium/Glass



Bombillas recomendadas-Suggested bulbs

K	Wat LED	On/Off	Dimmable	Lumens
2700K	7W	R09254	R09257	510lm
3000K	7W	R09255	R09258	540lm
4000K	7W	R09256	R09259	570lm



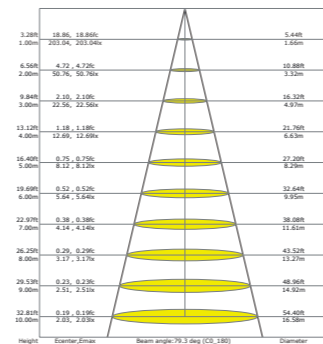
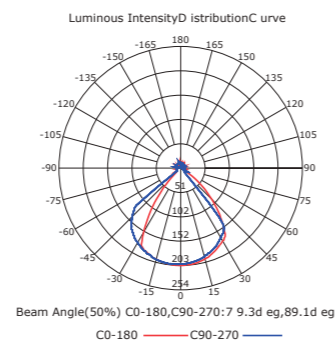
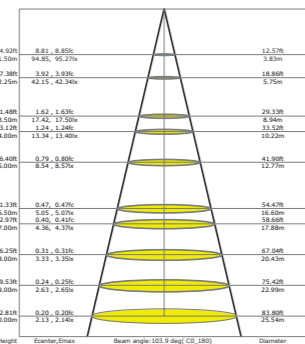
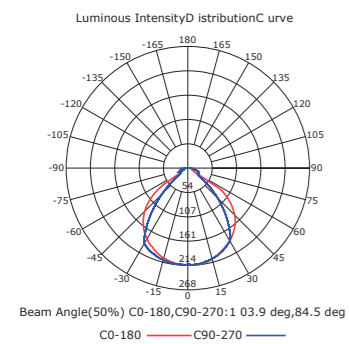

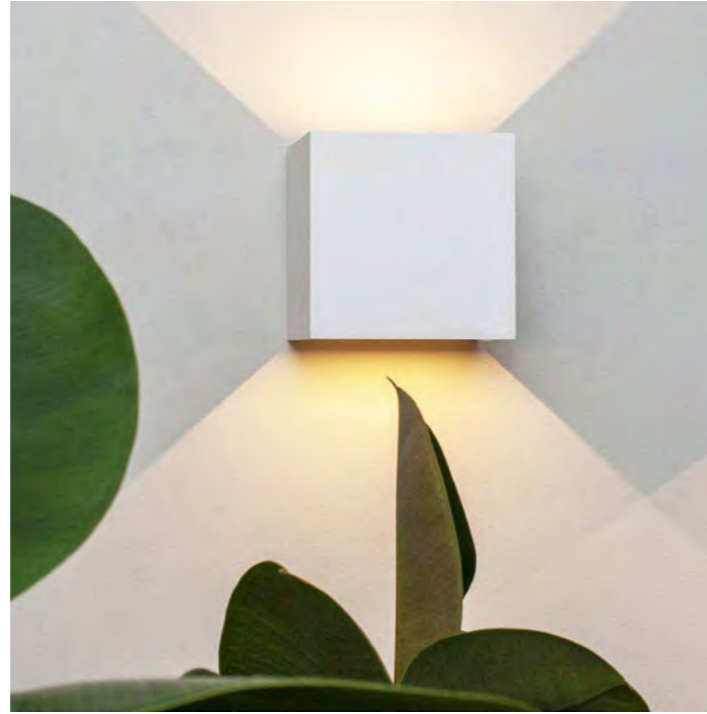

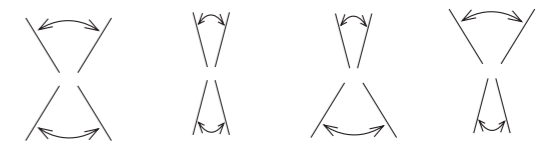
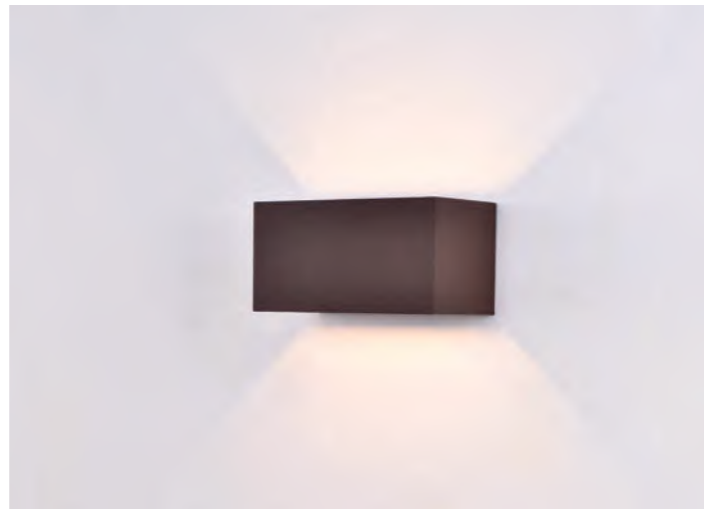
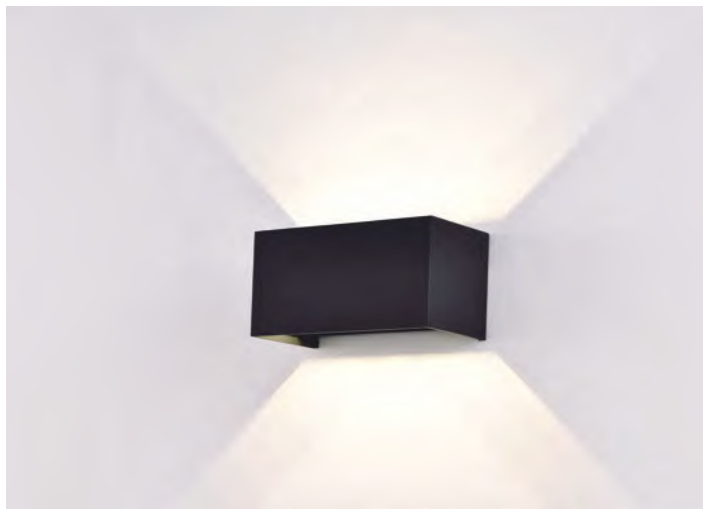
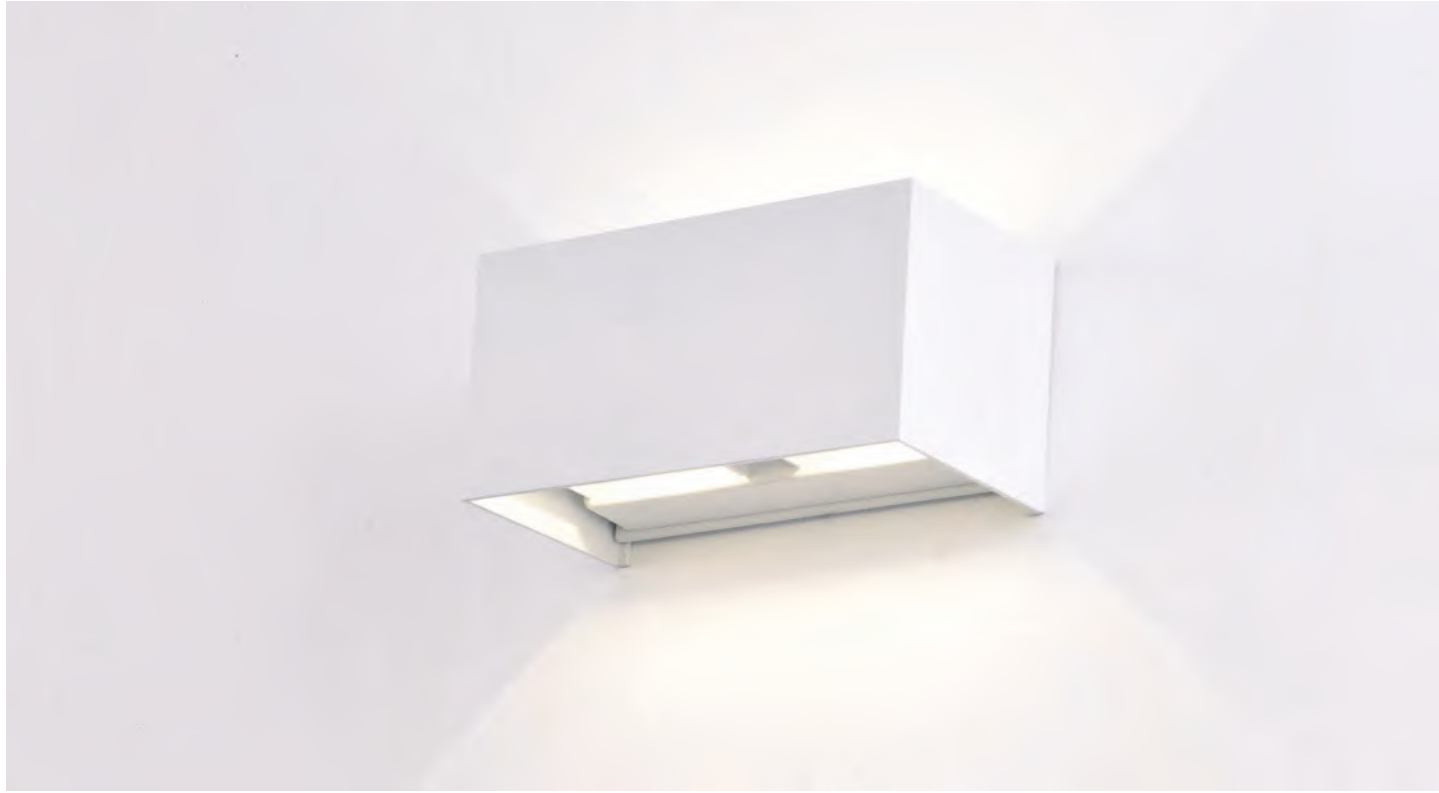

Outdoor

REFERENCE	K	LED WATT	LUMENS	FINISH	IP	DAVOS																																																																																																																																																																																																																																																				
New 8589	2700K	12W	1100lm	Gris oscuro-Dark grey	54	Dimmable																																																																																																																																																																																																																																																				
New 8600	2700K	12W	1100lm	Blanco arena-Sand white	54	Dimmable																																																																																																																																																																																																																																																				
New 8601	2700K	12W	1100lm	Negro arena-Sand black	54	Dimmable																																																																																																																																																																																																																																																				
New 8602	2700K	12W	1100lm	Corten-Corten	54	Dimmable																																																																																																																																																																																																																																																				
6520	3000K	12W	1100lm	Gris oscuro-Dark grey	54	On-off																																																																																																																																																																																																																																																				
6521	3000K	12W	1100lm	Blanco arena-Sand white	54	On-off																																																																																																																																																																																																																																																				
6524	3000K	12W	1100lm	Negro arena-Sand black	54	On-off																																																																																																																																																																																																																																																				
6527	3000K	12W	1100lm	Corten-Corten	54	On-off																																																																																																																																																																																																																																																				
7647	4000K	12W	1100lm	Gris oscuro-Dark grey	54	On-off																																																																																																																																																																																																																																																				
7648	4000K	12W	1100lm	Blanco arena-Sand white	54	On-off																																																																																																																																																																																																																																																				
7649	4000K	12W <td 1100lm	Negro arena-Sand black	54	On-off	7650	4000K	12W	1100lm	Corten-Corten	54	On-off	DAVOS							New 8604	2700K	12W	1100lm	Negro arena-Sand black	54	Dimmable	New 8603	2700K	12W	1100lm	Blanco arena-Sand white	54	Dimmable	6522	3000K	12W	1100lm	Gris oscuro-Dark grey	54	On-off	6523	3000K	12W	1100lm	Blanco arena-Sand white	54	On-off	7645	4000K	12W	1100lm	Gris oscuro-Dark grey	54	On-off	7646	4000K	12W	1100lm	Blanco arena-Sand white	54	On-off	DAVOS XL							New 8609	2700K	20W	1830lm	Gris oscuro-Dark grey	65	Dimmable	New 8610	2700K	20W	1830lm	Blanco arena-Sand white	65	Dimmable	New 8611	2700K	20W	1830lm	Negro arena-Sand black	65	Dimmable	New 8612	2700K	20W	1830lm	Corten-Corten	65	Dimmable	7435	3000K	20W	1830lm	Gris oscuro-Dark grey	65	On-off	7436	3000K	20W	1830lm	Blanco arena-Sand white	65	On-off	7437	3000K	20W	1830lm	Negro arena-Sand black	65	On-off	7438	3000K	20W	1830lm	Corten-Corten	65	On-off	7651	4000K	20W	1830lm	Gris oscuro-Dark grey	65	On-off	7652	4000K	20W	1830lm	Blanco arena-Sand white	65	On-off	7653	4000K	20W	1830lm	Negro arena-Sand black	65	On-off	7654	4000K	20W	1830lm	Corten-Corten	65	On-off	DAVOS DOUBLE							New 8605	2700K	24W	2200lm	Gris oscuro-Dark grey	54	Dimmable	New 8606	2700K	24W	2200lm	Blanco arena-Sand white	54	Dimmable	New 8607	2700K	24W	2200lm	Negro arena-Sand black	54	Dimmable	New 8608	2700K	24W	2200lm	Corten-Corten	54	Dimmable	7815	3000K	24W	2200lm	Gris oscuro-Dark grey	54	On-off	7816	3000K	24W	2200lm	Blanco arena-Sand white	54	On-off	7817	3000K	24W	2200lm	Negro arena-Sand black	54	On-off	7818	3000K	24W	2200lm	Corten-Corten	54	On-off	7819	4000K	24W	2200lm	Gris oscuro-Dark grey	54	On-off	7820	4000K	24W	2200lm	Blanco arena-Sand white	54	On-off	7821	4000K	24W	2200lm	Negro arena-Sand black	54	On-off	7822	4000K	24W	2200lm	Corten-Corten	54	On-off			220-240V ~ 50/60Hz		Aluminio-Aluminium		
7650	4000K	12W	1100lm	Corten-Corten	54	On-off																																																																																																																																																																																																																																																				
DAVOS																																																																																																																																																																																																																																																										
New 8604	2700K	12W	1100lm	Negro arena-Sand black	54	Dimmable																																																																																																																																																																																																																																																				
New 8603	2700K	12W	1100lm	Blanco arena-Sand white	54	Dimmable																																																																																																																																																																																																																																																				
6522	3000K	12W	1100lm	Gris oscuro-Dark grey	54	On-off																																																																																																																																																																																																																																																				
6523	3000K	12W	1100lm	Blanco arena-Sand white	54	On-off																																																																																																																																																																																																																																																				
7645	4000K	12W	1100lm	Gris oscuro-Dark grey	54	On-off																																																																																																																																																																																																																																																				
7646	4000K	12W	1100lm	Blanco arena-Sand white	54	On-off																																																																																																																																																																																																																																																				
DAVOS XL																																																																																																																																																																																																																																																										
New 8609	2700K	20W	1830lm	Gris oscuro-Dark grey	65	Dimmable																																																																																																																																																																																																																																																				
New 8610	2700K	20W	1830lm	Blanco arena-Sand white	65	Dimmable																																																																																																																																																																																																																																																				
New 8611	2700K	20W	1830lm	Negro arena-Sand black	65	Dimmable																																																																																																																																																																																																																																																				
New 8612	2700K	20W	1830lm	Corten-Corten	65	Dimmable																																																																																																																																																																																																																																																				
7435	3000K	20W	1830lm	Gris oscuro-Dark grey	65	On-off																																																																																																																																																																																																																																																				
7436	3000K	20W	1830lm	Blanco arena-Sand white	65	On-off																																																																																																																																																																																																																																																				
7437	3000K	20W	1830lm	Negro arena-Sand black	65	On-off																																																																																																																																																																																																																																																				
7438	3000K	20W	1830lm	Corten-Corten	65	On-off																																																																																																																																																																																																																																																				
7651	4000K	20W	1830lm	Gris oscuro-Dark grey	65	On-off																																																																																																																																																																																																																																																				
7652	4000K	20W	1830lm	Blanco arena-Sand white	65	On-off																																																																																																																																																																																																																																																				
7653	4000K	20W	1830lm	Negro arena-Sand black	65	On-off																																																																																																																																																																																																																																																				
7654	4000K	20W	1830lm	Corten-Corten	65	On-off																																																																																																																																																																																																																																																				
DAVOS DOUBLE																																																																																																																																																																																																																																																										
New 8605	2700K	24W	2200lm	Gris oscuro-Dark grey	54	Dimmable																																																																																																																																																																																																																																																				
New 8606	2700K	24W	2200lm	Blanco arena-Sand white	54	Dimmable																																																																																																																																																																																																																																																				
New 8607	2700K	24W	2200lm	Negro arena-Sand black	54	Dimmable																																																																																																																																																																																																																																																				
New 8608	2700K	24W	2200lm	Corten-Corten	54	Dimmable																																																																																																																																																																																																																																																				
7815	3000K	24W	2200lm	Gris oscuro-Dark grey	54	On-off																																																																																																																																																																																																																																																				
7816	3000K	24W	2200lm	Blanco arena-Sand white	54	On-off																																																																																																																																																																																																																																																				
7817	3000K	24W	2200lm	Negro arena-Sand black	54	On-off																																																																																																																																																																																																																																																				
7818	3000K	24W	2200lm	Corten-Corten	54	On-off																																																																																																																																																																																																																																																				
7819	4000K	24W	2200lm	Gris oscuro-Dark grey	54	On-off																																																																																																																																																																																																																																																				
7820	4000K	24W	2200lm	Blanco arena-Sand white	54	On-off																																																																																																																																																																																																																																																				
7821	4000K	24W	2200lm	Negro arena-Sand black	54	On-off																																																																																																																																																																																																																																																				
7822	4000K	24W	2200lm	Corten-Corten	54	On-off																																																																																																																																																																																																																																																				
		220-240V ~ 50/60Hz		Aluminio-Aluminium																																																																																																																																																																																																																																																						

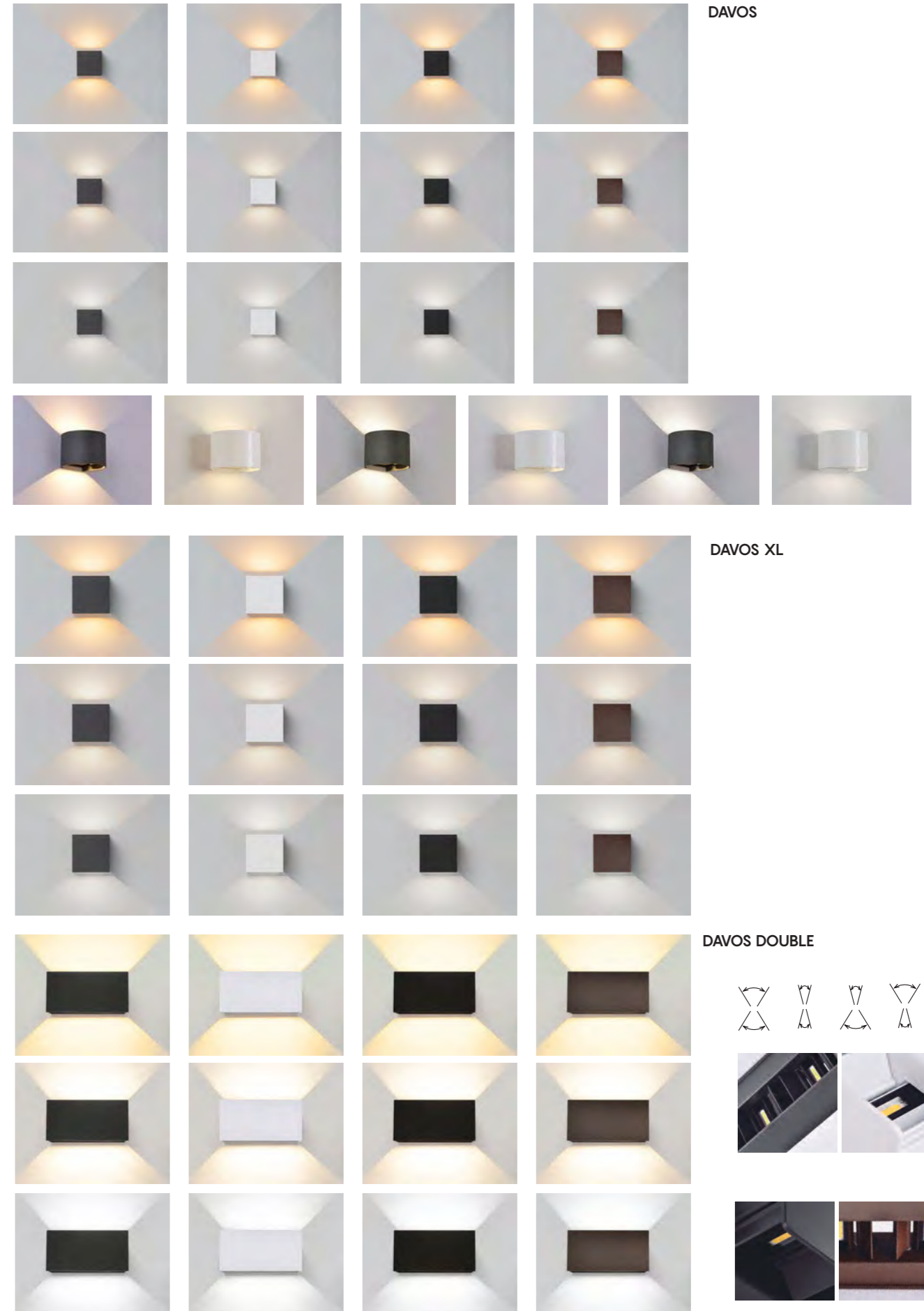
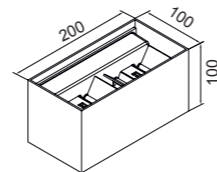
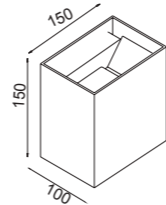
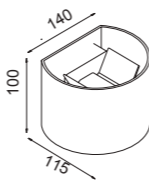
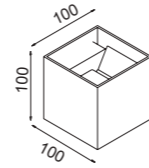

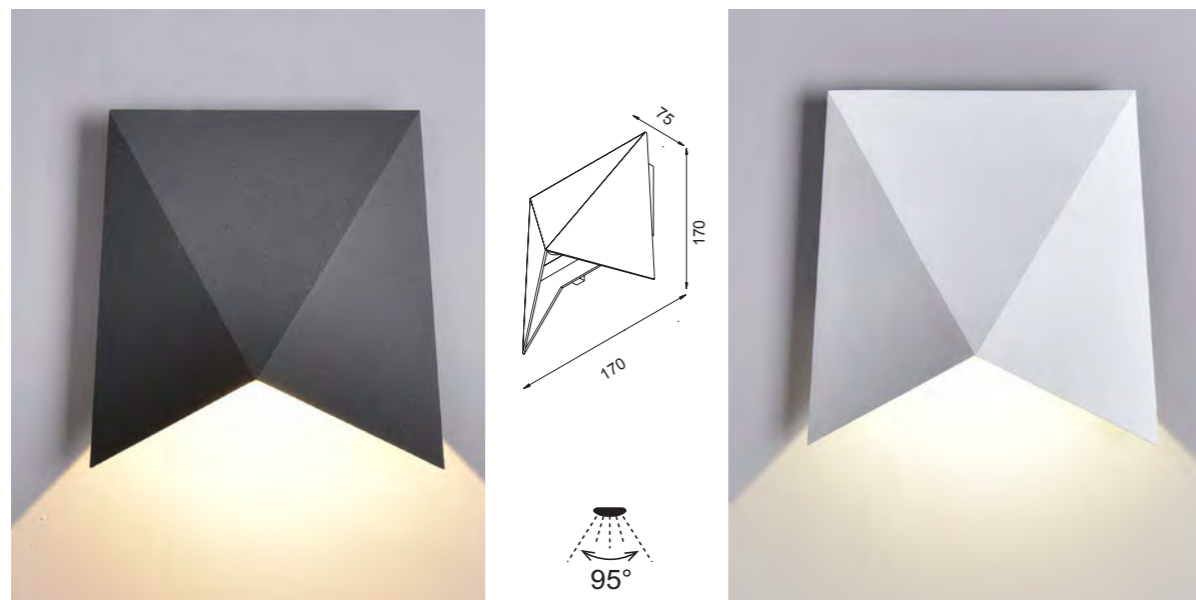

REFERENCE	K	LED WATT	LUMENS	FINISH
6525	3000K	8W	750m	Gris oscuro-Dark grey
6526	3000K	8W	750m	Blanco arena-Sand white
220-240V ~ 50/60Hz CRI ≥80				Aluminio-Aluminium

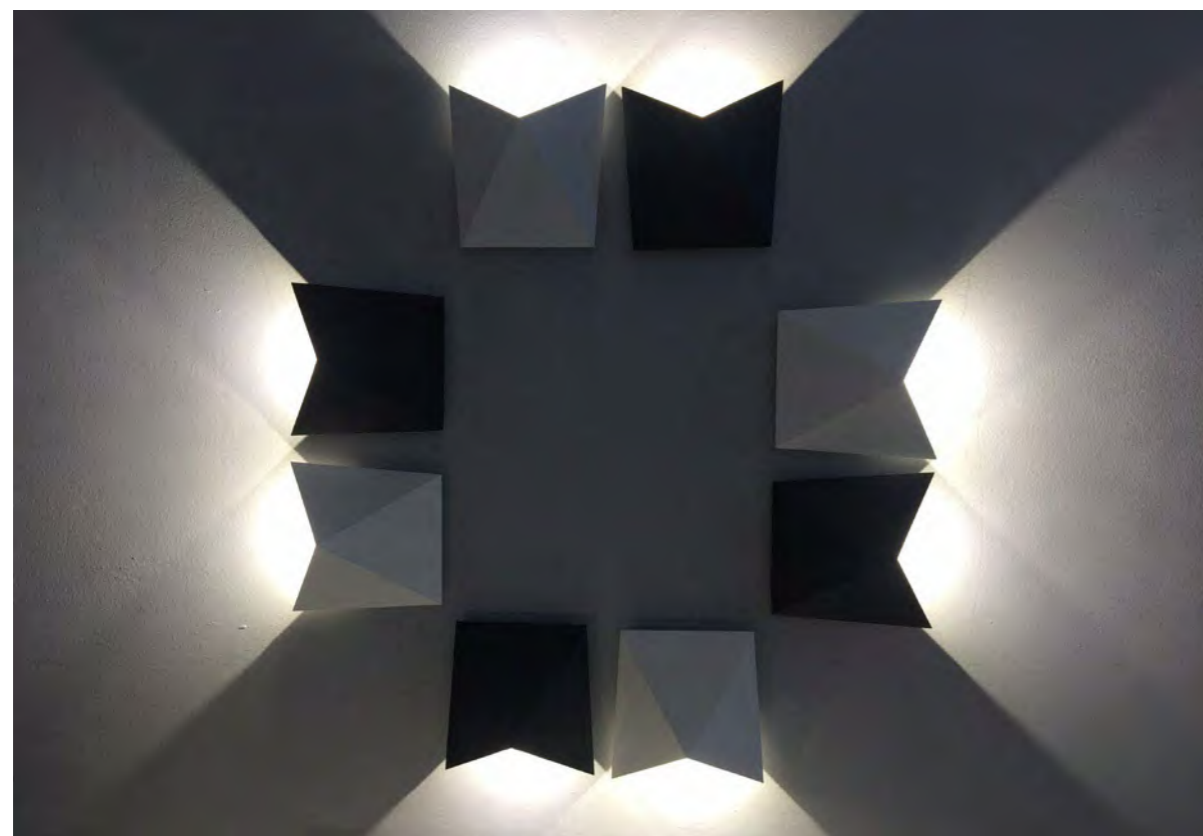

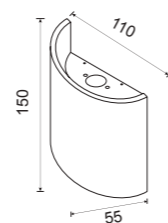
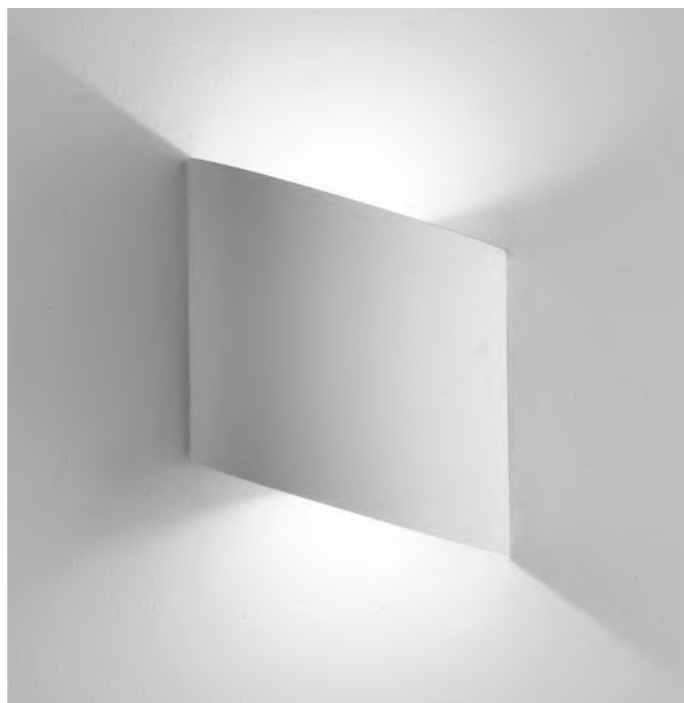
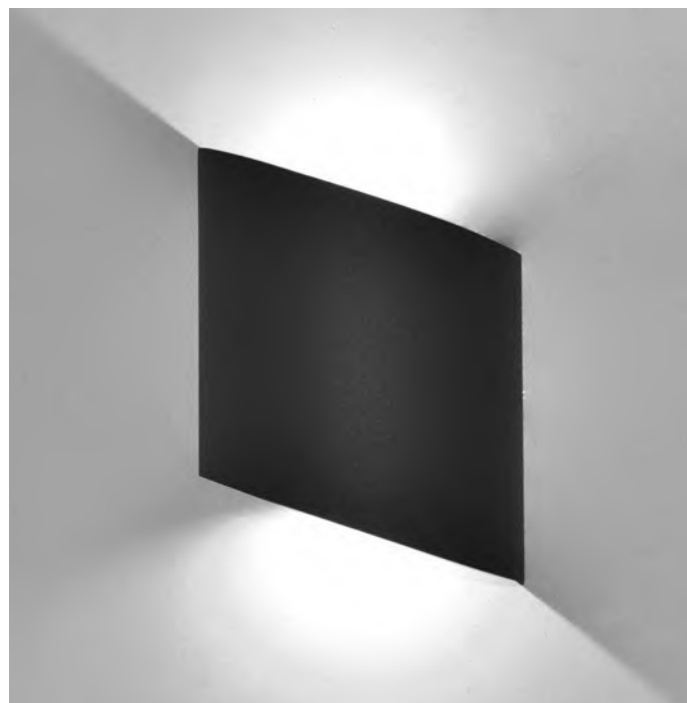

REFERENCE	K	LED WATT	LUMENS	FINISH
6530	3000K	6W	660lm	Gris oscuro-Dark grey
6531	3000K	6W	660lm	Blanco arena-Sand white
220-240V~ 5 0/60Hz CRI ≥80				Aluminio-Aluminium

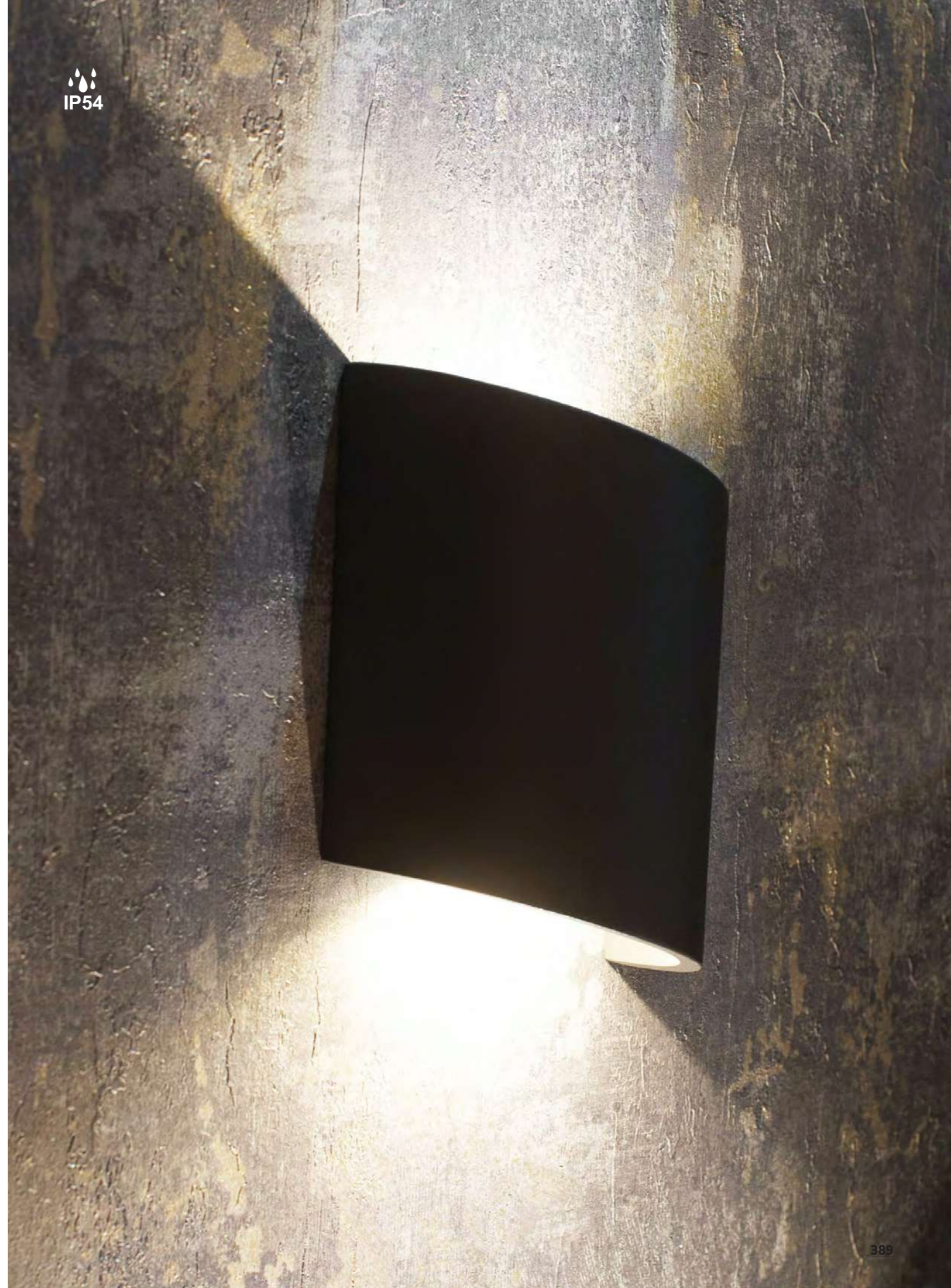



IP54



REFERENCE	K	LED WATT	LUMENS	FINISH	
6534	3000K	9.6W	720lm	Gris oscuro-Dark grey	ø 150
6535	3000K	9.6W	720lm	Blanco-White	ø 150
6538	3000K	9.6W	720lm	Corten-Corten	ø 150
6536	3000K	9.6W	720lm	Gris oscuro-Dark grey	150 x 150
6537	3000K	9.6W	720lm	Blanco-White	150 x 150
6539	3000K	9.6W	720lm	Corten-Corten	150 x 150
				Aluminio-Aluminium	

220-240V~ 50/60Hz



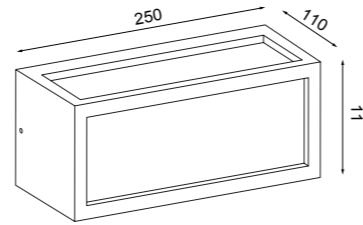

REFERENCE	BULB NO INCLUDED	FINISH
7050	1L x E27	Gris Oscuro-Dark Grey
7051	1L x E27	Blanco-White
7052	1L x E27	Corten-Corten
máx. 20W LED (No incl)		100-240V~ 50/60Hz Aluminio-Aluminium

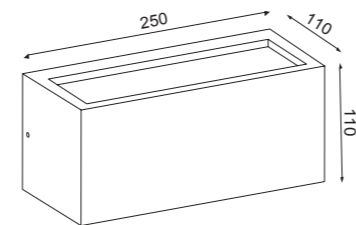

REFERENCE	BULBS NOT INCLUDED	FINISH
New 8352	1L x E27	Gris Oscuro-Dark Grey
New 8353	1L x E27	Blanco-White
New 8354	1L x E27	Corten-Corten
máx. 20W LED (No incl)		100-240V~ 50/60Hz Aluminio-Aluminium



8379
pág. 418

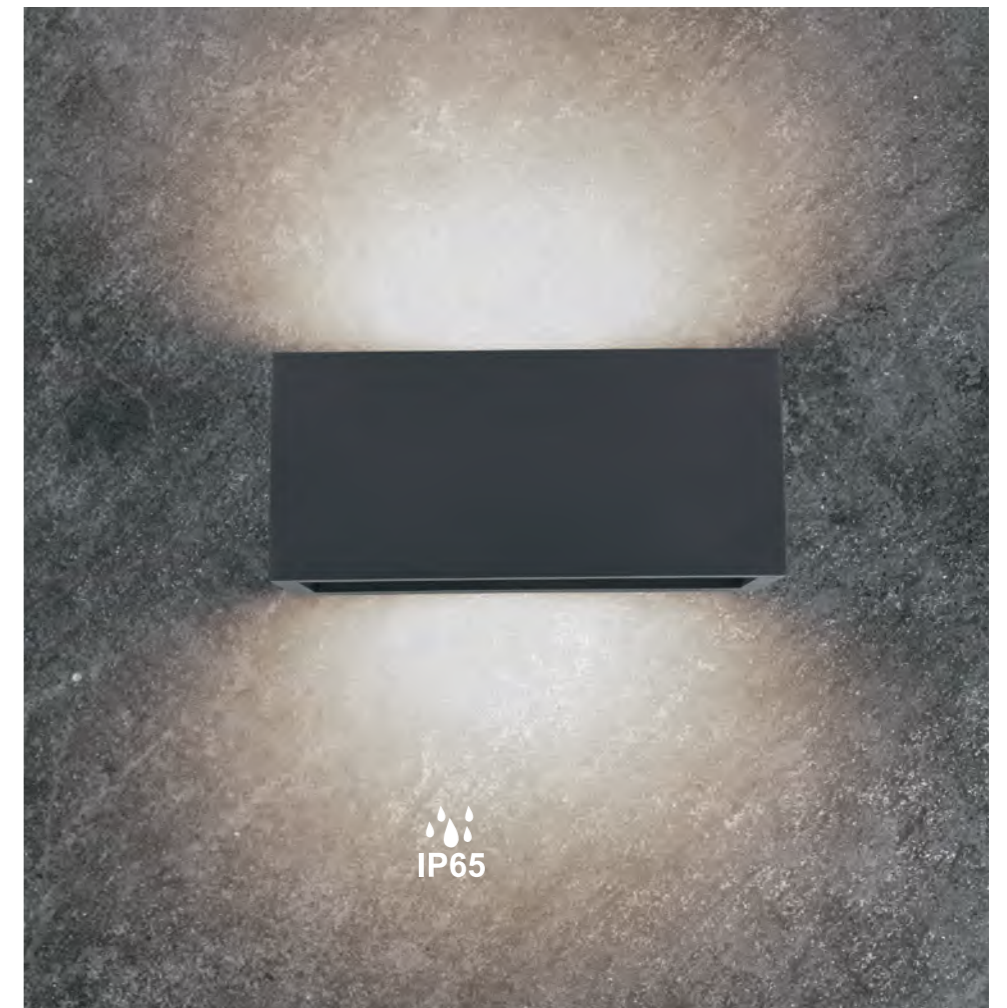

Outdoor

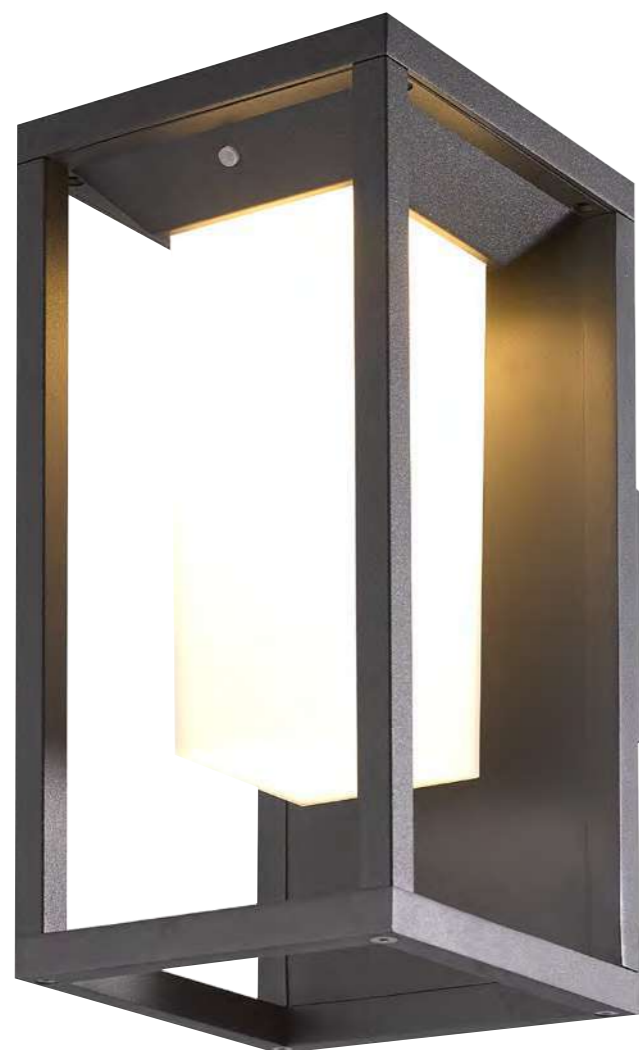

PIR sensor
A:120°
D:≤6m

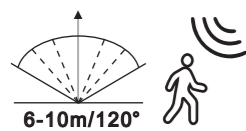
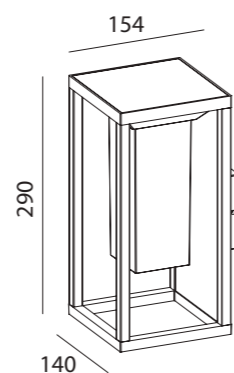

Charge: 6-8h (Sunshine)
Work time: Full light 3h / Micro light 25h



6495 pág. 364 7085 pág. 456 6490 pág. 458

REFERENCE	K	LED WATT	LUMENS	FINISH
7086	3000K	2,2W	188lm	Grafito-Graphite
		DC 3.7V CRI≥ 80	Aluminio-Aluminium	



IP54

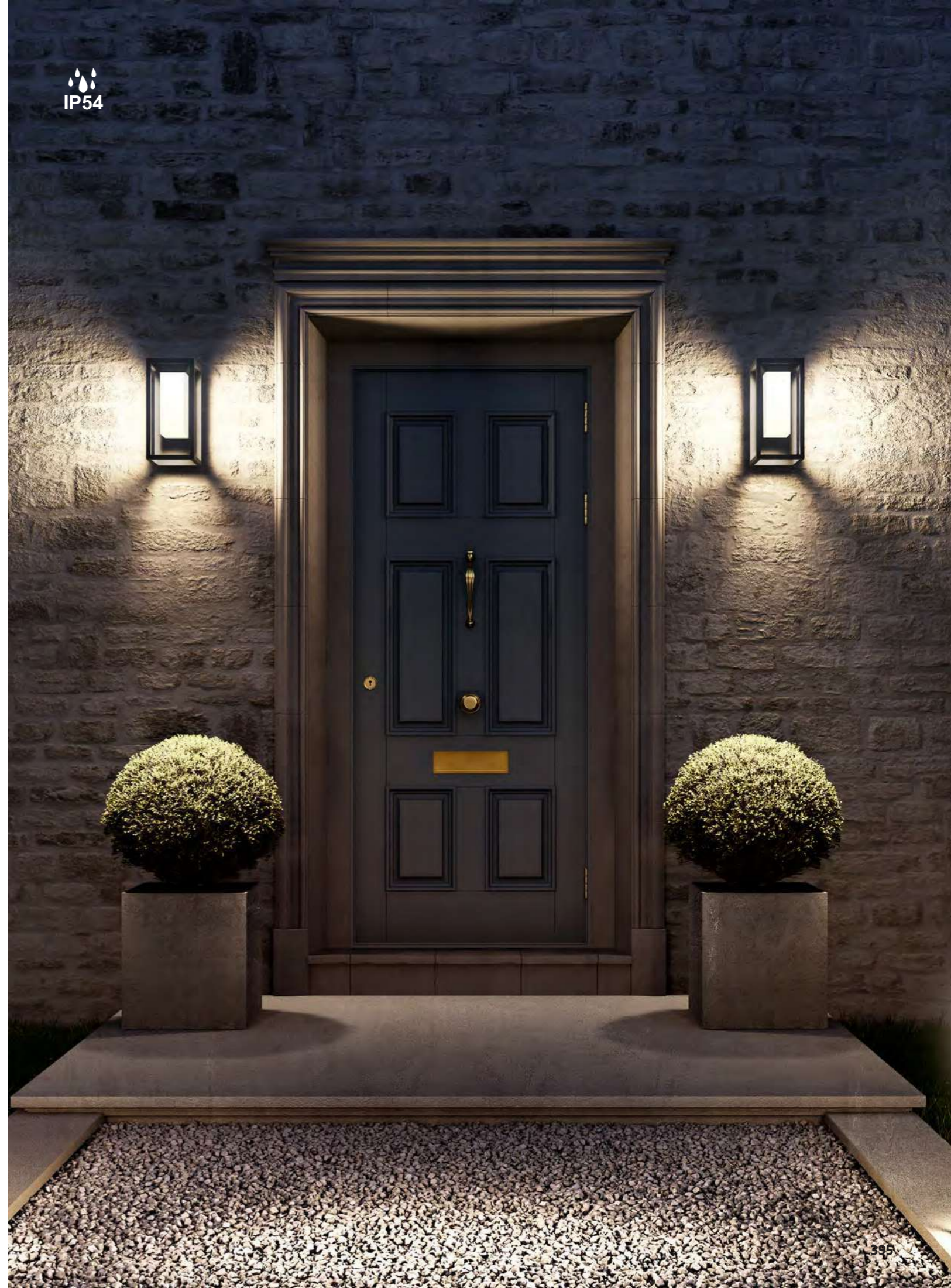

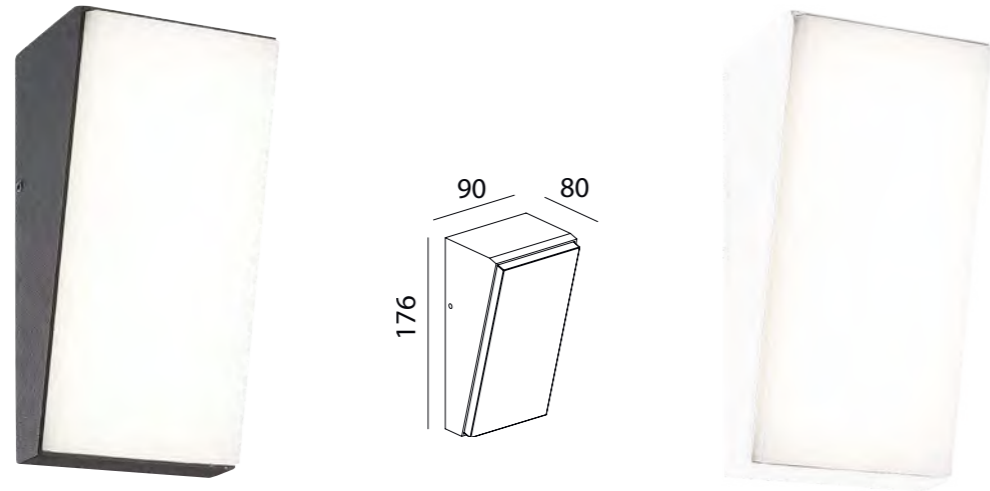

REFERENCE	K	LED WATT	LUMENS	FINISH
7072	3000K	9W	762lm	Gris oscuro-Dark grey
7073	3000K	9W	762lm	Blanco-White
		100-240V~ 50/60Hz CRI≥ 80		Aluminio/PC-Aluminium/PC

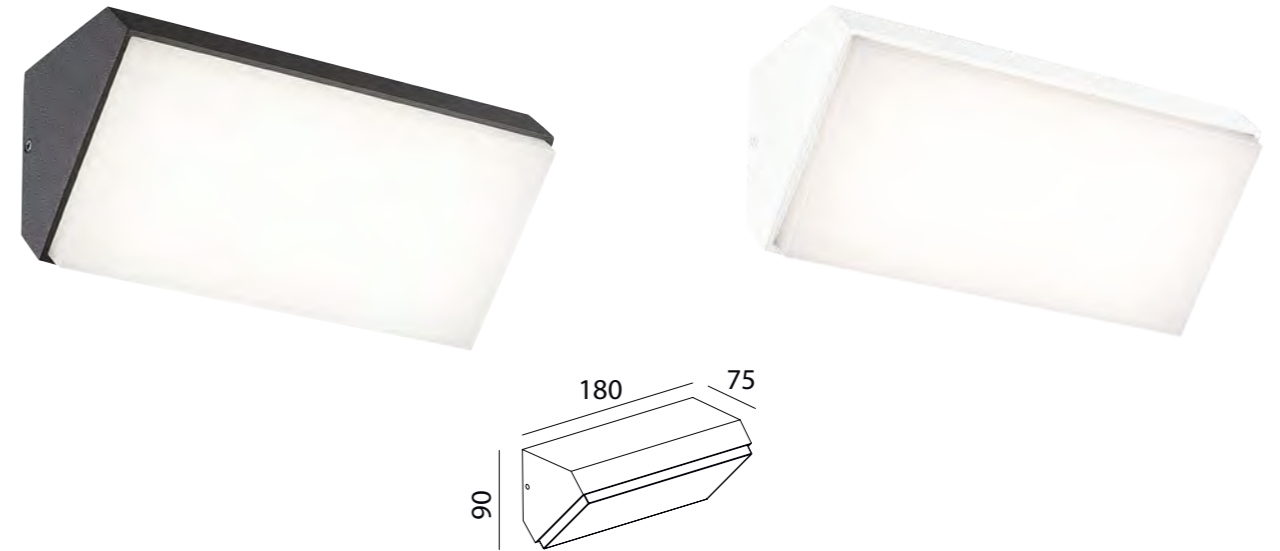

REFERENCE	K	LED WATT	LUMENS	FINISH
7070	3000K	9W	773lm	Gris oscuro-Dark grey
7071	3000K	9W	773lm	Blanco-White
		100-240V~ 50/60Hz CRI≥ 80		Aluminio/PC-Aluminium/PC





8471



8470



8473



8472

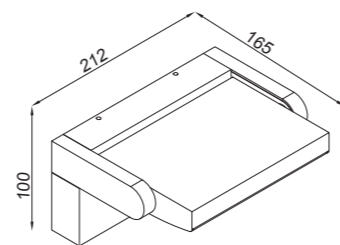

350°



REFERENCE	CCT switch	LED WATT	LUMENS	FINISH	SENSOR
8470	3000K	20W	1700lm	Blanco-White	No
8471	3000K	20W	1700lm	Negro-Black	No
8472	3000K	20W	1700lm	Blanco-White	Yes
8473	3000K	20W	1700lm	Negro-Black	Yes
				220-240V~ 50/60Hz CRI:≥ 80	Aluminio-Aluminium

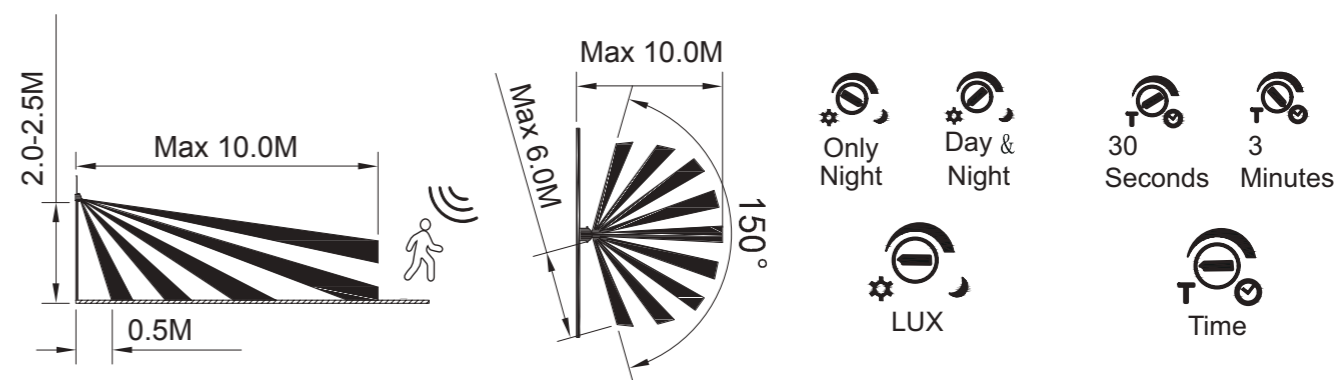

COOPER

New

Apliques exterior-Outdoor wall lights

Outdoor



8474



8475



8476



8477

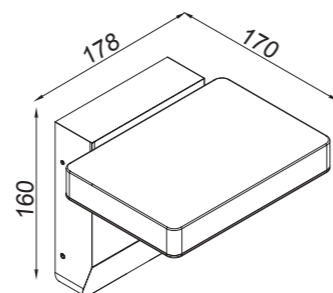
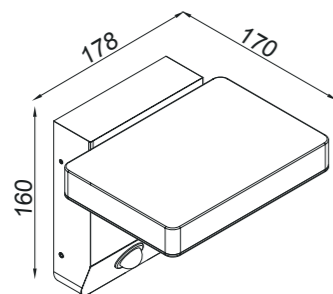

REFERENCE	CCT switch	LED WATT	LUMENS	FINISH	SENSOR
8474	3000K	20W	1700lm	Blanco-White	No
8475	3000K	20W	1700lm	Negro-Black	No
8476	3000K	20W	1700lm	Blanco-White	Yes
8477	3000K	20W	1700lm	Negro-Black	Yes
				220-240V~ 50/60Hz CRI:≥ 80	Aluminio-Aluminium

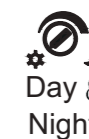
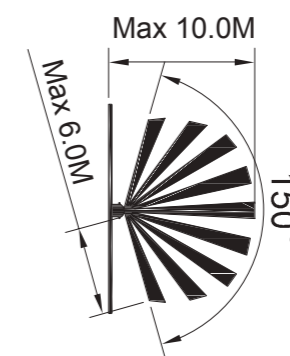
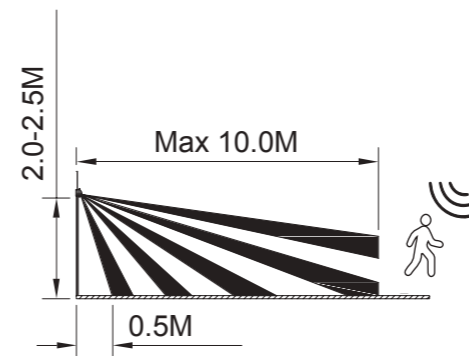



LUMINOUS INTENSITY DISTRIBUTION DIAGRAM

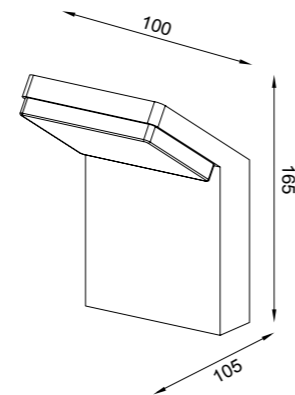
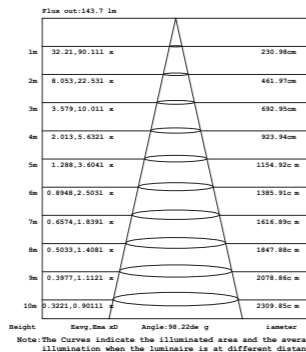
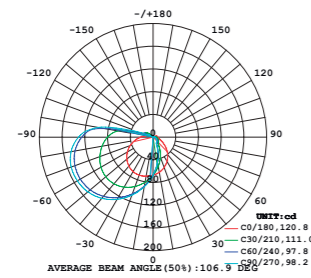

REFERENCE	K	LED WATT	LUMENS	FINISH
7045	3000K	6W	510lm	Gris oscuro-Dark grey
7046	3000K	6W	510lm	Blanco-White
220-240V ~ 50/60Hz CRI ≥ 80				Aluminio/PC-Aluminium/PC



8151
pág. 468



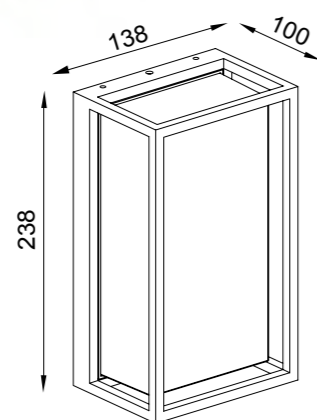

REFERENCE	K	LED WATT	LUMENS	FINISH
7062	3000K	9W	725lm	Gris oscuro-Dark grey
7063	3000K	9W	725lm	Blanco-White
		220-240V~ 50/60Hz CRI≥ 80		Aluminio/PC-Aluminium/PC



7060
pág. 422



IP65

DRIVER
TUV

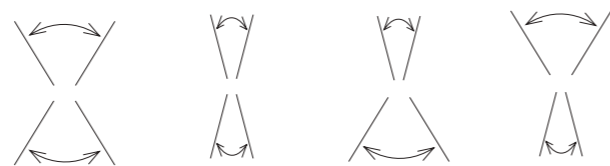
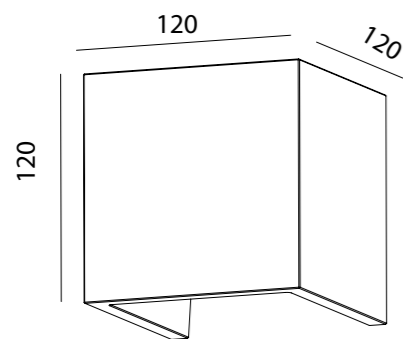

REFERENCE	K	LED WATT	LUMENS	FINISH
7108	3000K	12W	1100lm	Gris Piedra-Stone Grey
7109	3000K	12W	1100lm	Blanco-White
		220-240V~ 50/60Hz	Cemento liso-Smooth cement	



7107
pág. 482

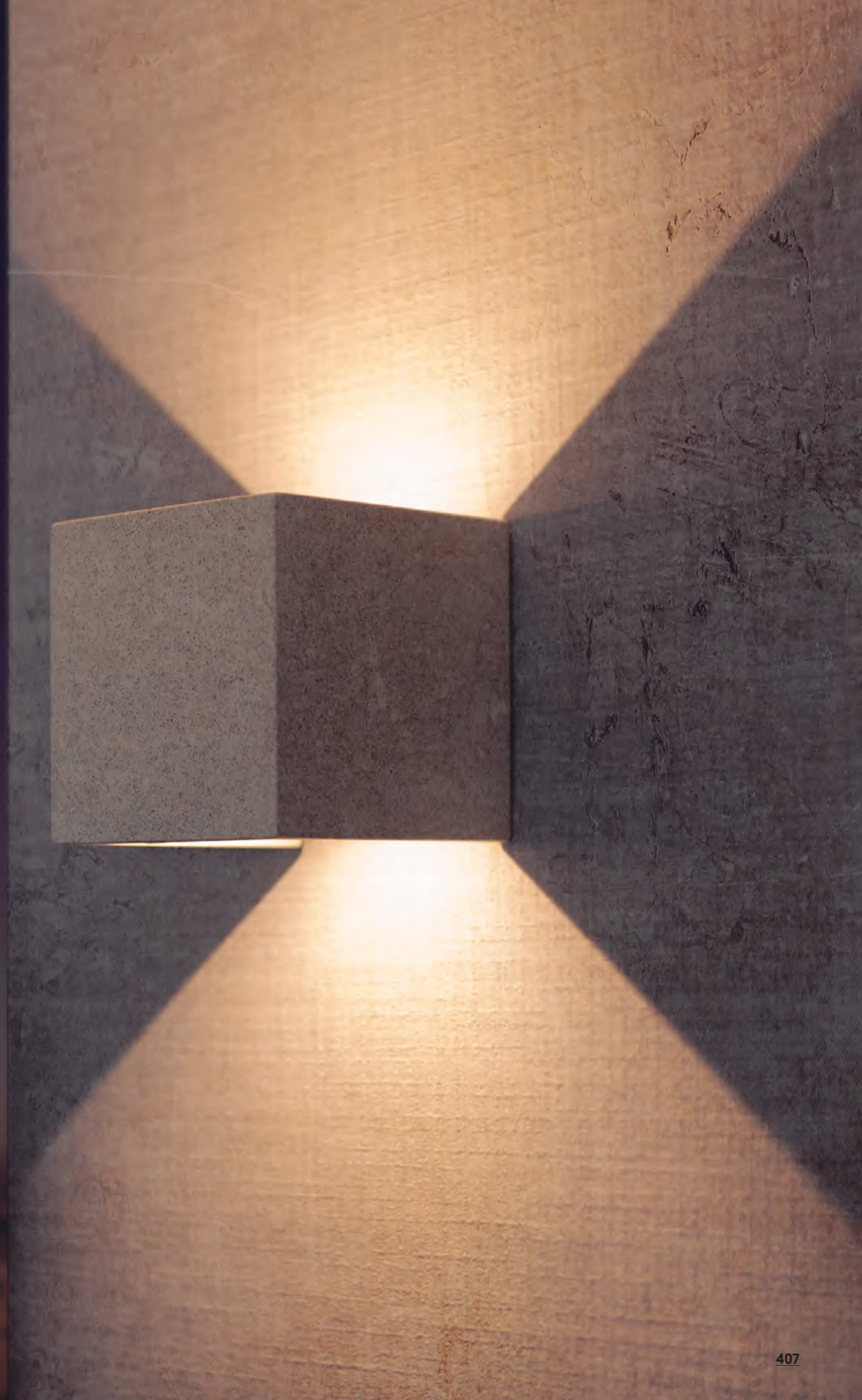

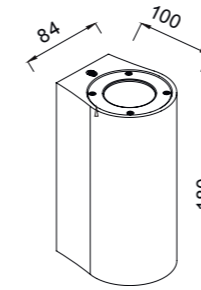
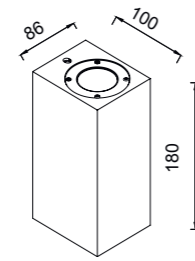

REFERENCE	BULB NO INCLUDED	FINISH
7182	2L x GU10	Blanco-White
7183	2L x GU10	Gris oscuro-Dark grey
máx. 12W LED (No incl)		100-240V~ 50/60Hz Hormigón-Concrete



7187
pág. 426

REFERENCE	BULB NO INCLUDED	FINISH
7180	2L x GU10	Blanco-White
7181	2L x GU10	Gris oscuro-Dark grey
máx. 12W LED (No incl)		100-240V~ 50/60Hz Hormigón-Concrete



Plafón exterior

Outdoor ceiling lamp

KANDANCHÚ

Plafón exterior-Outdoor ceiling lamp

Outdoor

Plafón exterior-Ceiling lamp outdoor



REFERENCE	BULB NO INCLUDED	FINISH
7900	GU10	Blanco-White
7901	GU10	Gris oscuro-Dark grey
7902	GU10	Negro-Black
7903	GU10	Corten-Corten
1x GU10 máx.10W		100-240V- 50/60Hz Aluminio/Cristal-Aluminium/Glass

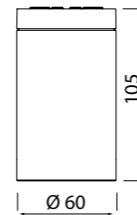

REFERENCE	BULB NO INCLUDED	FINISH
7904	GU10	Blanco-White
7905	GU10	Gris oscuro-Dark grey
7906	GU10	Negro-Black
7907	GU10	Corten-Corten
1x GU10 máx.10W		100-240V- 50/60Hz Aluminio/Cristal-Aluminium/Glass

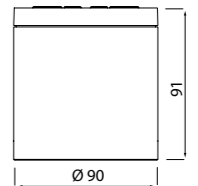

Bombillas recomendadas-Suggested bulbs

K	Wat LED	On/Off	Dimmable	Lumens
2700K	7W	R09254	R09257	510lm
3000K	7W	R09255	R09258	540lm
4000K	7W	R09256	R09259	570lm



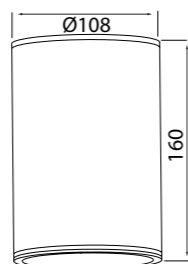

REFERENCE	BULB NO INCLUDED	FINISH
7908	E27	Gris Oscuro-Dark Grey
	1x E27 máx.20W	100-240V - 50/60Hz Aluminio/Cristal-Aluminium/Glass



6483
pág. 370

Bombillas recomendadas-Suggested bulbs

REFERENCE	Wattios LED	CCT	Lumens	Ángulo luz
R09133	10W	3000K	1050lm	320°
R09215	10W	4000K	1080lm	320°
R09134	10W	5000K	1100lm	320°
R09139	14W	3000K	1460lm	240°
R09140	14W	4000K	1510lm	240°



MAYA

by José Ignacio Ballester

Outdoor



6553

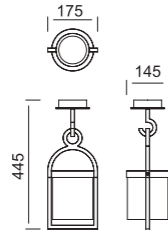

6554

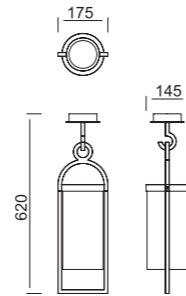

REFERENCE	BULB NO INCLUDED	FINISH
6553	1L x E27	Gris oscuro-Dark grey
6554	1L x E27	Gris oscuro-Dark grey
máx. 20W LED (No incl)		100-240V~ 50/60Hz Aluminio/cristal-Aluminium/glass



6550 pág. 460 6555 pág. 438 6551 pág. 360



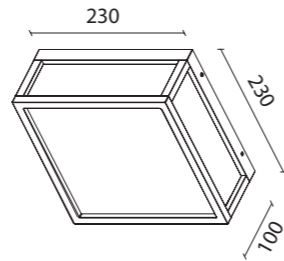

8379 7051
pág. 392 pág. 392

REFERENCE	BULBS NOT INCLUDED	FINISH
8378	2L x E27	Gris Oscuro-Dark Grey
8379	2L x E27	Blanco-White
8380	2L x E27	Corten-Corten
máx. 20W LED (No incl)		100-240V ~ 50/60Hz Aluminio-Aluminium





7065



7066

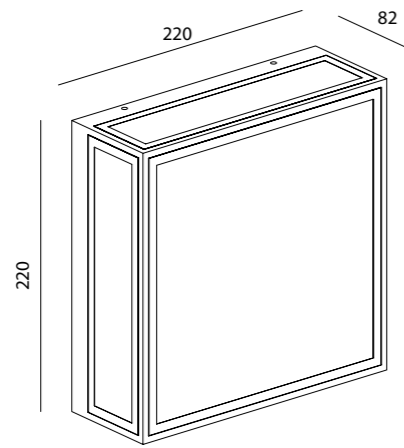

REFERENCE	BULB NO INCLUDED	FINISH
7065	2L x E27	Gris oscuro-Dark grey
7066	2L x E27	Gris oscuro-Dark grey
máx. 20W LED (No incl)		100-240V~ 50/60Hz Aluminio/cristal-Aluminium/glass



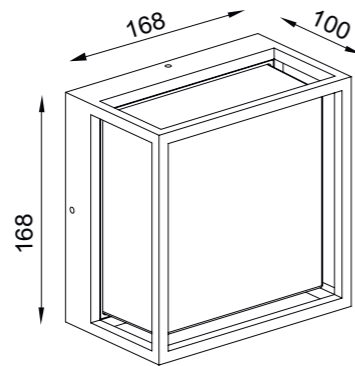

REFERENCE	K	LED WATT	LUMENS	FINISH
7060	3000K	9W	725lm	Gris oscuro-Dark grey
7061	3000K	9W	725lm	Blanco-White
		220-240V~ 50/60Hz	Aluminio/PC-Aluminium/PC	



7062
pág. 404

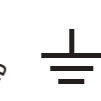
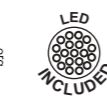

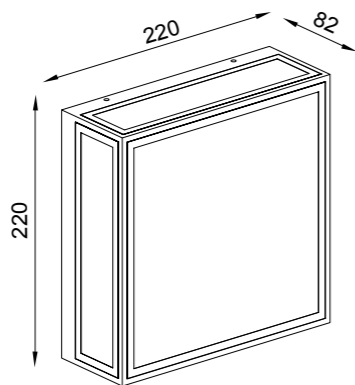

REFERENCE	K	LED WATT	LUMENS	FINISH
7055	3000K	14W	1180lm	Gris oscuro-Dark grey
7056	3000K	14W	1180lm	Blanco-White
		100-240V~ 50/60Hz CRI≥ 80		Aluminio/Cristal-Aluminium/Glass



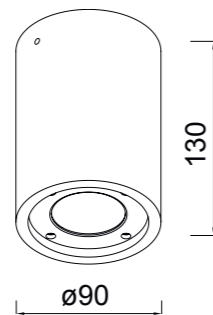

REFERENCE	BULB NO INCLUDED	FINISH
7184	1L x GU10	Blanco-White
7185	1L x GU10	Gris oscuro-Dark grey
máx. 12W LED (No incl)		100-240V~ 50/60Hz Hormigón-Concrete



7181
pág. 409

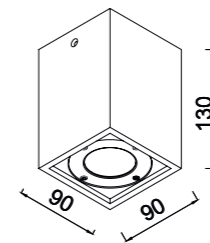

7183
pág. 408

REFERENCE	BULB NO INCLUDED	FINISH
7186	1L x GU10	Blanco-White
7187	1L x GU10	Gris oscuro-Dark grey
máx. 12W LED (No incl)		100-240V~ 50/60Hz Hormigón-Concrete



Colgantes exterior

Outdoor single pendants

POLINESIA
By Santiago Sevillano

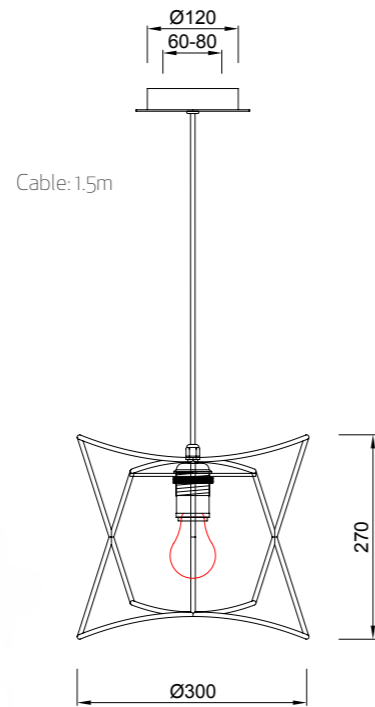

7133
pág. 358

IP44



REFERENCE	BULB NO INCLUDED	FINISH
7131	1L x E27	Beige oscuro-Dark beige
máx. 20W LED (No incl) 100-240V~ 50/60Hz Aluminio/fibra textil sintética-Aluminium/synthetic textile fibre		



POLINESIA
By Santiago Sevillano

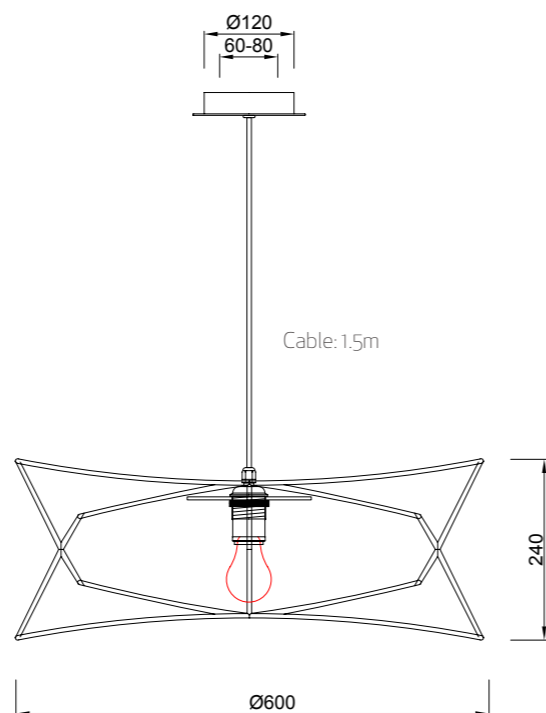

IP44



REFERENCE	BULB NOT INCLUDED	FINISH
7130	1L x E27	Beige oscuro-Dark beige
máx. 20W LED (No incl) 100-240V~ 50/60Hz Aluminio/fibra textil sintética-Aluminium/synthetic textile fibre		



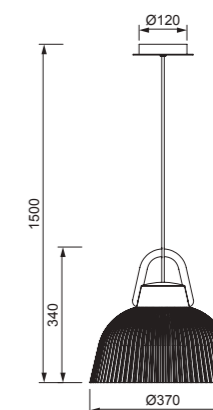
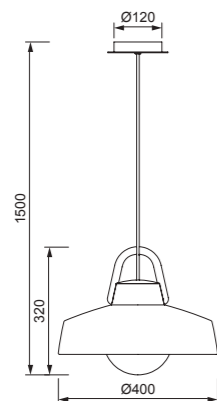

REFERENCE	BULB NO INCLUDED	FINISH
6212	1L x E27	Blanco/Gris antracita-White/Gray Anthracite
	máx. 20W LED (No incl)	100-240V ~ 50/60Hz ABS/PE/Aluminium

REFERENCE	BULB NO INCLUDED	FINISH
6211	1L x E27	Blanco/Gris antracita-White/Gray Anthracite
	máx. 20W LED (No incl)	100-240V ~ 50/60Hz ABS/PE/Aluminium

OAMI 004721413-023/024/025



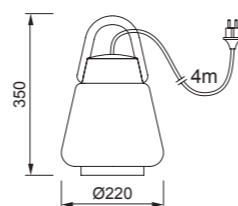

REFERENCE	BULB NO INCLUDED	FINISH
6213	1L x E27	Blanco/Gris antracita-White/Gray Anthracite
	máx. 20W LED (No incl)	100-240V~ 50/60Hz ABS/PE/Aluminium

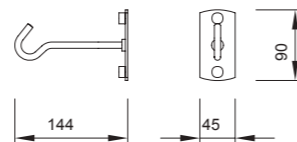
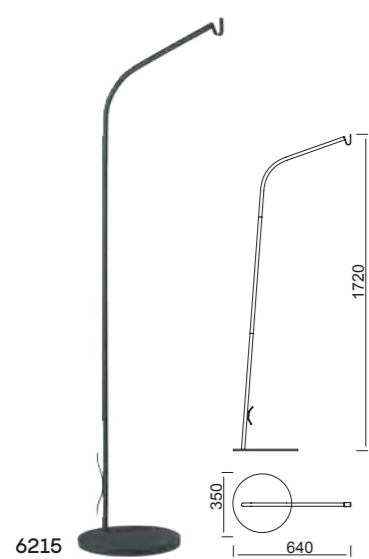

REFERENCE	FINISH	
6215	Peana-Base	Gris antracita/Gray Anthracite
6214	Gancho-Hook	Gris antracita/Gray Anthracite
6218	Peana-Base	Acero Inoxidable-Base mármol negro Stainless Steel-Black marble base

OAMI 004721413-023/024/025



6213+6215

MAYA

by José Ignacio Ballester

Colgantes exterior-Outdoor pendant lamp

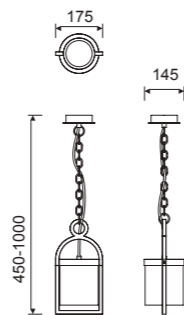

6553 pág. 416 6550 pág. 460 6551 pág. 360

REFERENCE	BULB NO INCLUDED	FINISH
6555	1L x E27	Gris oscuro-Dark grey
	máx. 20W LED (No incl)	100-240V~ 50/60Hz Aluminio/cristal-Aluminium/glass



IP54

OAMI 005818614-0006

MAYA





IP44



REFERENCE	BULB NO INCLUDED	FINISH	
1397	1L x E27	Blanco-White	ø350
1398	1L x E27	Blanco-White	ø400
1399	1L x E27	Blanco-White	ø500
máx. 20W LED (No incl)		PE / ABS / Aluminio-PE / ABS / Aluminium	

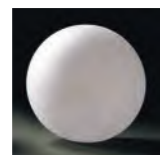
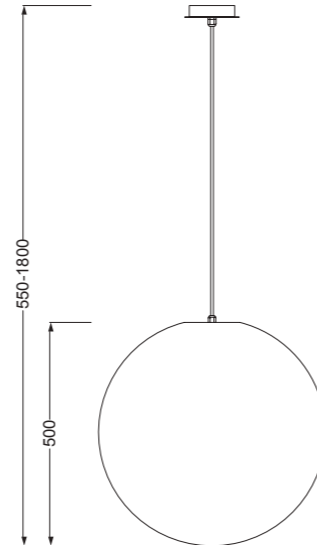
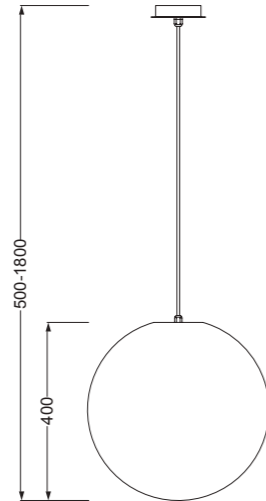
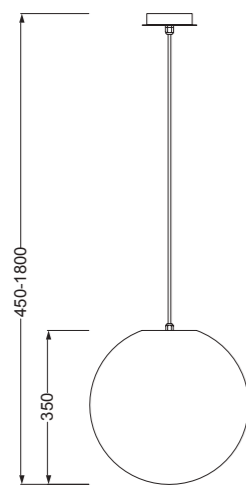

1388
pág. 478



Sobremesa exterior
Outdoor table Lamp



REFERENCE	K	LED WATT	LUMENS	FINISH
7930	3000K	2W	180lm	Blanco-White
7931	3000K	2W	180lm	Negro-Black
7932	3000K	2W	180lm	Corten-Corten
		DC 5V / 1A	Aluminio-Aluminium	

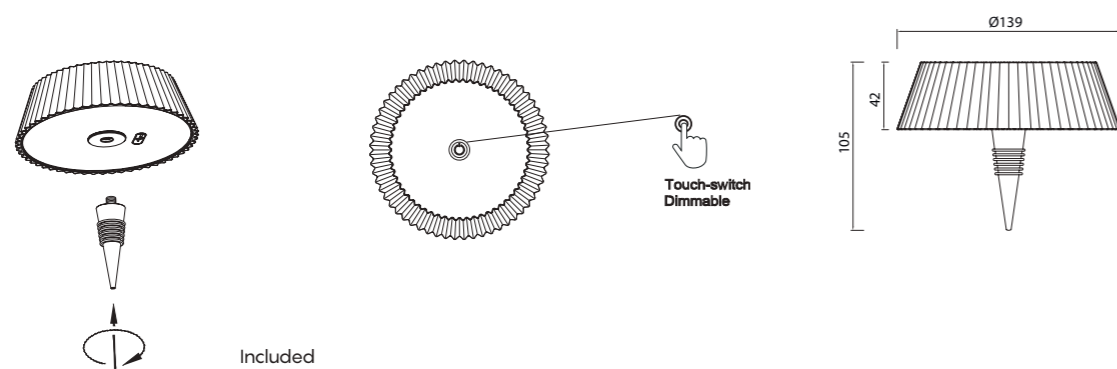

Included

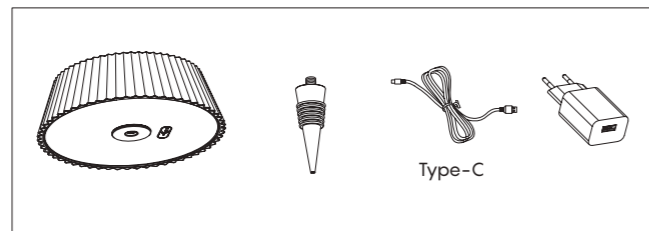



REFERENCE	K	LED WATT	LUMENS	FINISH
7933	3000K	2W	180lm	Blanco-White
7934	3000K	2W	180lm	Negro-Black
7935	3000K	2W	180lm	Corten-Corten
		DC 5V / 1A	Aluminio-Aluminium	

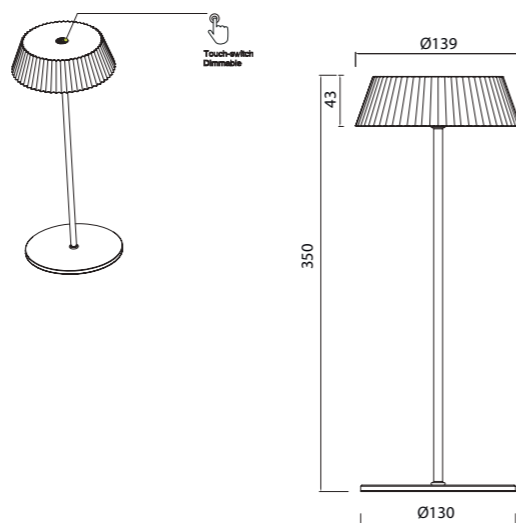

Included

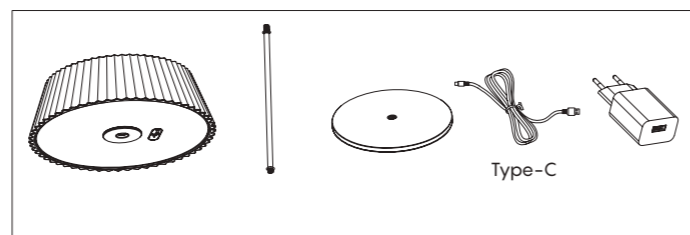



REFERENCE	K	LED WATT	LUMENS	FINISH
7988	3000K	2W	230lm	Blanco-White
7989	3000K	2W	230lm	Negro-Black
		DC 5V/1A CRI≥ 80	Aluminio/PC-Aluminum/PC	





REFERENCE	K	LED WATT	LUMENS	FINISH
7985	3000K	2W	180lm	Blanco-White
7986	3000K	2W	180lm	Negro-Black
7987	3000K	2W	180lm	Corten-Corten
DC 5V/1A CRI≥ 80				Aluminio-Aluminum



FLAME

by Santiago Sevillano Studio

Lámpara de suelo-Floor lamp

Outdoor

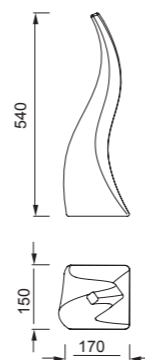

REFERENCE	BULB NO INCLUDED	FINISH
1326	1L x E27	Blanco-White
	máx. 20W LED (No incl)	100-240V ~ 50/60Hz PE/ABS-PE/ABS

Complementos Exterior-Outdoor Complements

Piqueta-Spike 210 mm	Piqueta-Spike 160 mm	Base-Ground base ø50
TU0652	TU0492	TU0494



1400
pág. 480

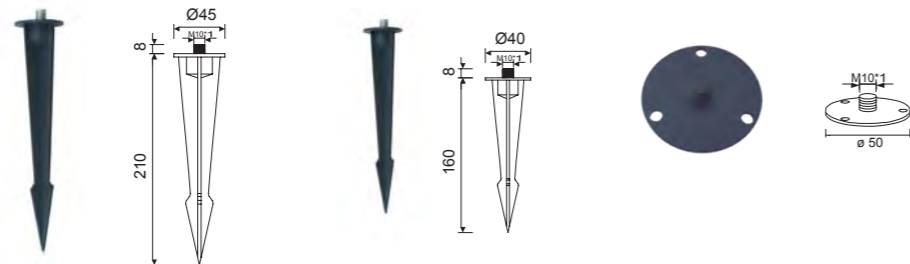

IP65

FLAME



Sobremuro exterior

Outdoor over wall



PIR sensor
A:120°
D:≤6m

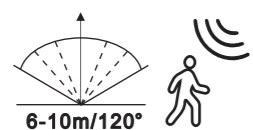

Charge: 6-8h (Sunshine)
Work time : Full light 3h / Micro light 25h

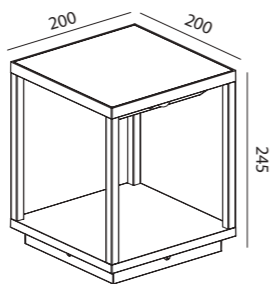

7086 pág. 394
6495 pág. 364

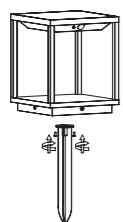

Included

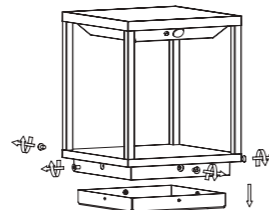
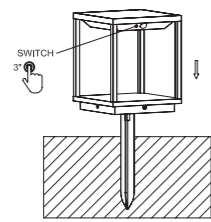

Included

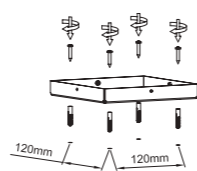

REFERENCE	K	LED WATT	LUMENS	FINISH
7085	3000K	3,5W	300lm	Grafito-Graphite
		DC 3.7V	CRi ≥ 80	Aluminio-Aluminum

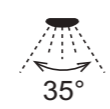

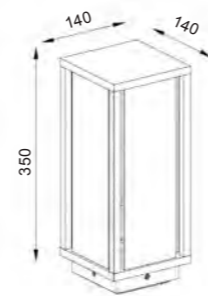

IP54



REFERENCE	BULB NO INCLUDED	FINISH
6490	1L x E27	Grafito-Graphite
	máx. 20W LED (No incl)	100-240V~ 50/60Hz Aluminio/cristal-Aluminium/glass



MAYA

by José Ignacio Ballester

Sobremuro exterior-Pedestal lamp

Outdoor

OAMI 005818614-0004

IP54

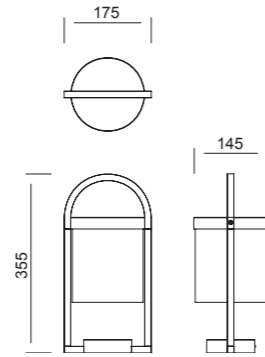

REFERENCE	BULB NO INCLUDED	FINISH
6550	1L x E27	Gris oscuro-Dark grey
	máx. 20W LED (No incl)	100-240V~ 50/60Hz Aluminio/cristal-Aluminium/glass



6553
pág. 416

6555
pág. 438

6551
pág. 360



Lámparas de suelo

Outdoor ground lamps



REFERENCE	K	LED WATT	LUMENS	FINISH	HEIGHT
6771	3000K	13W	980lm	Gris Oscuro/Madera-Dark Grey/Wood	350
6772	3000K	13W	980lm	Gris Oscuro/Madera-Dark Grey/Wood	600
6773	3000K	13W	980lm	Gris Oscuro/Madera-Dark Grey/Wood	1000
				Aluminio/PC-Aluminium/PC	

100-240V~ 50/60Hz CRI:≥ 80



6770
pág. 362



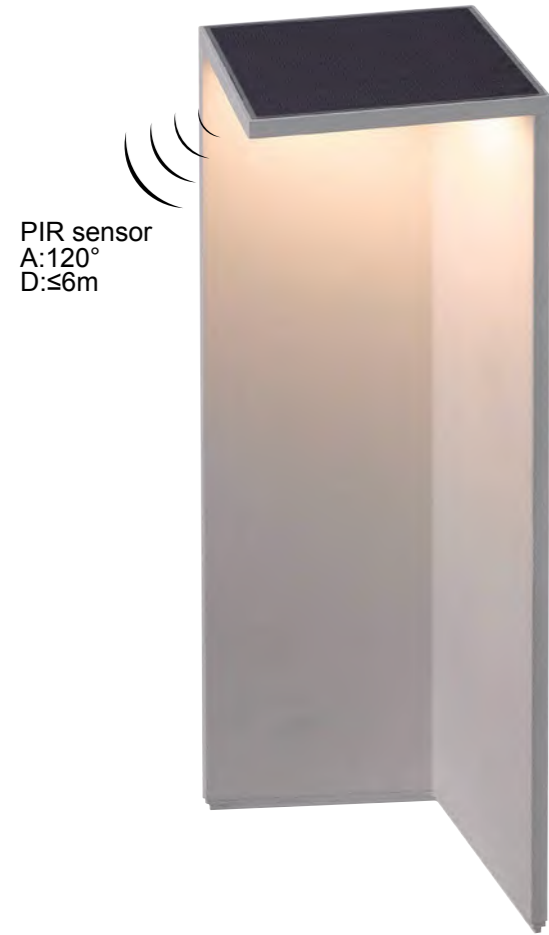

Charge: 6-8h (Sunshine)
Work time : Full light 3h / Micro light 25h

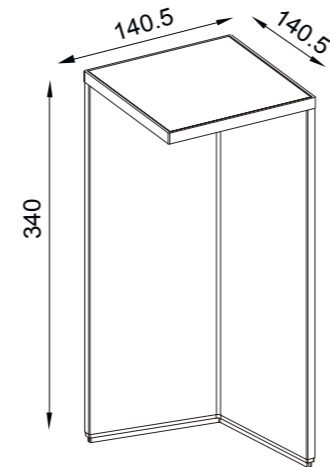
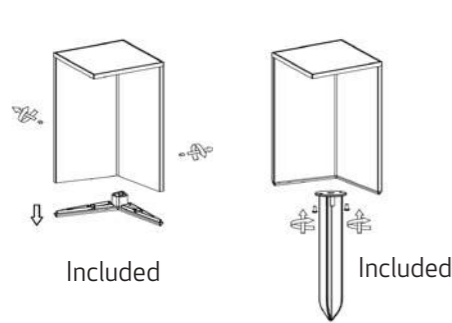

REFERENCE	K	LED WATT	LUMENS	FINISH
7088	3000K	2,2W	188lm	Grafito-Graphite
		DC 3.7V CRI≥ 80		Aluminio-Aluminium



IP54

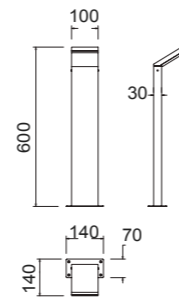

7045
pág. 402

REFERENCE	K	LED WATT	LUMENS	FINISH
8151	3000K	12W	1020lm	Gris oscuro-Dark grey
		220-240V~ 50/60Hz CRI:≥ 80		Aluminio/PC-Aluminium/PC





REFERENCE	BULB NO INCLUDED	FINISH
8108	1L x E27	Gris Oscuro-Dark grey
8109	1L x E27	Gris Oscuro-Dark grey
	máx. 20W LED (No incl)	100-240V - 50/60Hz Aluminium/PC-Aluminium/PC



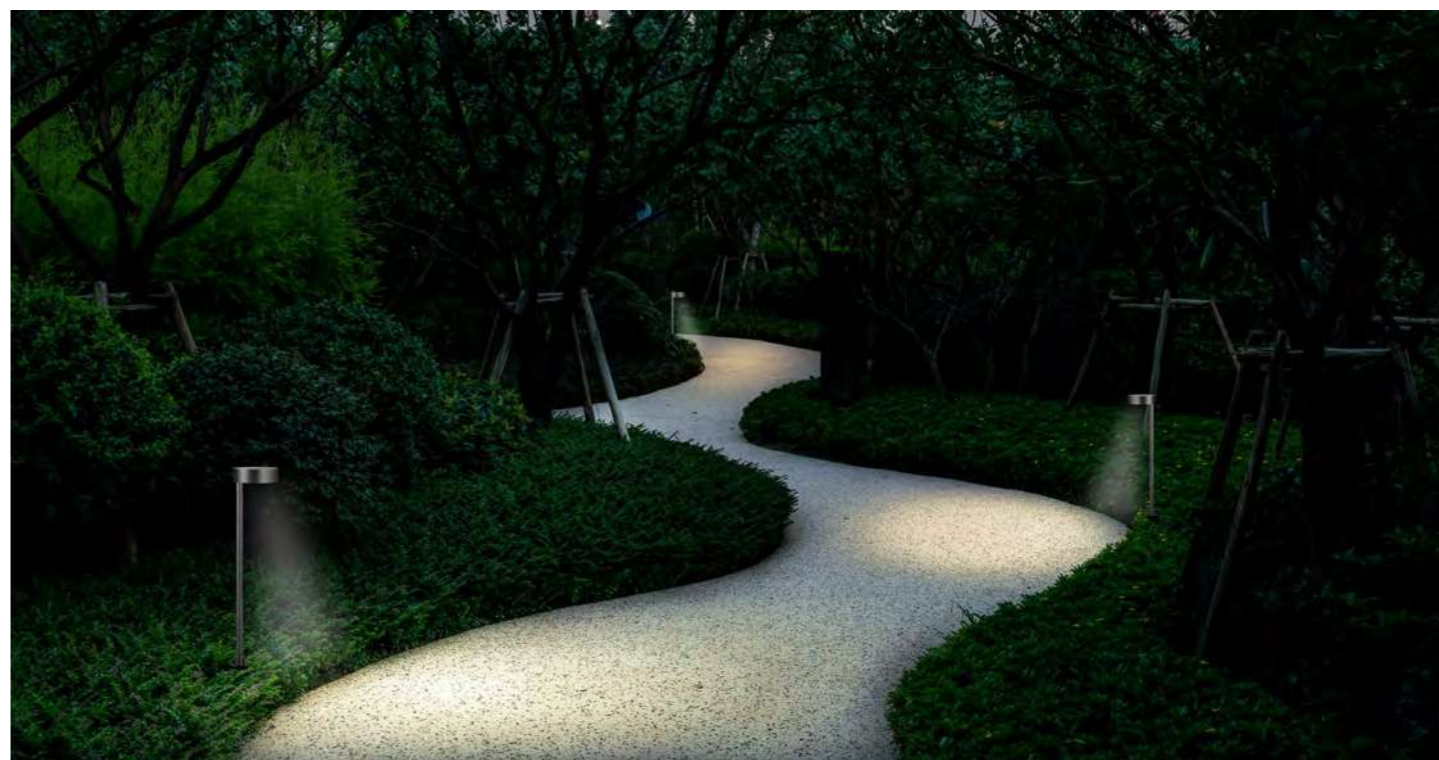

REFERENCE	K	LED WATT	LUMENS	FINISH
New 8478	3000K	7W	740lm	Negro-Black
New 8479	3000K	7W	740lm	Corten-Corten
220-240V ~ 50/60Hz CRI:≥ 80				Aluminio-Aluminium





REFERENCE	K	LED WATT	LUMENS	SIZE	FINISH
8480	3000K	12W	880lm	600 mm	Negro-Black
8481	3000K	12W	880lm	800 mm	Negro-Black
220-240V ~ 50/60Hz CRI:≥ 80					Aluminio-Aluminium





REFERENCE	BULB NO INCLUDED	FINISH
8155	1L x GU10	Negro-Black
	máx. 12W LED (No incl)	100-240V ~ 50/60Hz Aluminio-Aluminium

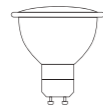

Bombillas recomendadas-Suggested bulbs

K	Wat LED	On/Off	Phase cut	Lumens
2700K	7W	R09254	R09257	510lm
3000K	7W	R09255	R09258	540lm
4000K	7W	R09256	R09259	570lm





REFERENCE	BULB NO INCLUDED	FINISH	
1388	1L x E27	Blanco-White	ø350
1391	1L x E27	Blanco-White	ø400
1394	1L x E27	Blanco-White	ø500
máx. 20W LED (No incl)		100-240V ~ 50/60Hz PE/ABS-PE/ABS	

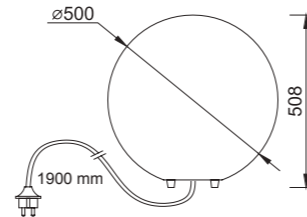
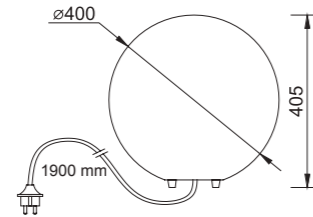
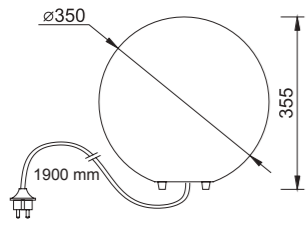

Complementos exterior *NO INCLUIDO-Outdoor complements *NOT INCLUDED

TU0492	TU0652	TU0653	TU0494



1397
pág. 440



FLAME

by Santiago Sevillano Studio

Lámpara de suelo-Floor lamp

Outdoor

IP65

OAMI 01793845-0001



REFERENCE	BULB NO INCLUDED	FINISH
1400	4L x GU10 máx 12W LED (No incl) 1L x E27 máx 20W LED (No incl)	Blanco-White
	100-240V~ 50/60Hz	PE/Acero-PE/Steel



Bombillas recomendadas-Suggested bulbs

BULB	Reference	Reference
GU10	R09219	R09220
E27	R09139	R09140

Complementos exterior *NO INCLUIDO-Outdoor complements *NOT INCLUDED

TU0652	TU0653	TU0494



1326
pág. 452

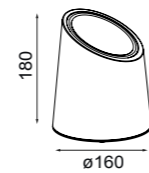

REFERENCE	BULB NO INCLUDED	FINISH
7107	1L x GU10	Gris Piedra-Stone Grey
	máx. 12W LED (No incl)	100-240V ~ 50/60Hz Cemento liso-Smooth cement



7108
pág. 406



Bombillas recomendadas-Suggested bulbs

K	Wat LED	On/Off	Phase cut	Lumens
2700K	7W	R09254	R09257	510lm
3000K	7W	R09255	R09258	540lm
4000K	7W	R09256	R09259	570lm



Señalizadores

Step wall lights

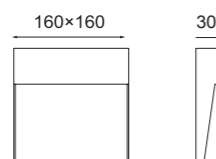
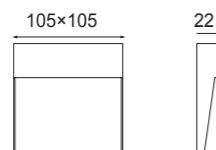

REFERENCE	K	LED WATT	LUMENS	FINISH
7011	3000K	3W	210lm	Gris Oscuro-DarkGrey
7012	3000K	3W	210lm	Blanco arena-Sand white
7640	3000K	3W	210lm	Corten-Corten
7015	3000K	6W	420lm	Gris Oscuro-DarkGrey
7016	3000K	6W	420lm	Blanco arena-Sand white
7642	3000K	6W	420lm	Corten-Corten
				220-240V~ 50/60Hz CRI:≥ 80
				Aluminio/PC-Aluminium/PC

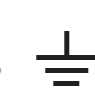

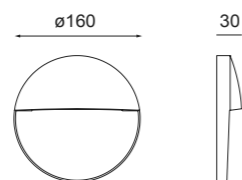
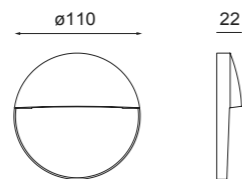

REFERENCE	K	LED WATT	LUMENS	FINISH
7013	3000K	3W	210lm	Gris Oscuro-Dark Grey
7014	3000K	3W	210lm	Blanco arena-Sand white
7641	3000K	3W	210lm	Corten-Corten
7017	3000K	6W	420lm	Gris Oscuro-Dark Grey
7018	3000K	6W	420lm	Blanco arena-Sand white
7643	3000K	6W	420lm	Corten-Corten
220-240V~ 50/60Hz CRI:≥ 80				Aluminio/PC-Aluminium/PC



ASPEN

Señalizadores empotrables-Recessed step wall lights

Outdoor

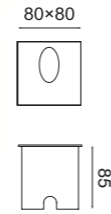
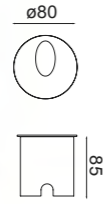

REFERENCE	K	LED WATT	LUMENS	FINISH
7021	3000K	3W	210lm	Gris Oscuro-Dark Grey
7022	3000K	3W	210lm	Negro arena-Sand black
7023	3000K	3W	210lm	Blanco arena-Sand white
7024	3000K	3W	210lm	Gris Oscuro-Dark Grey
7025	3000K	3W	210lm	Negro arena-Sand black
7026	3000K	3W	210lm	Blanco arena-Sand white
200-240V~ 50/60Hz CRI:≥ 80				Aluminio/PC-Aluminium/PC

LUMINOUS INTENSITY DISTRIBUTION DIAGRAM

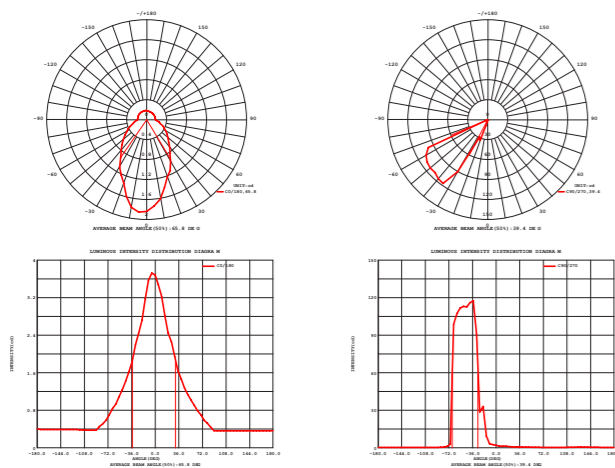

LUMINOUS INTENSITY DISTRIBUTION DIAGRAM

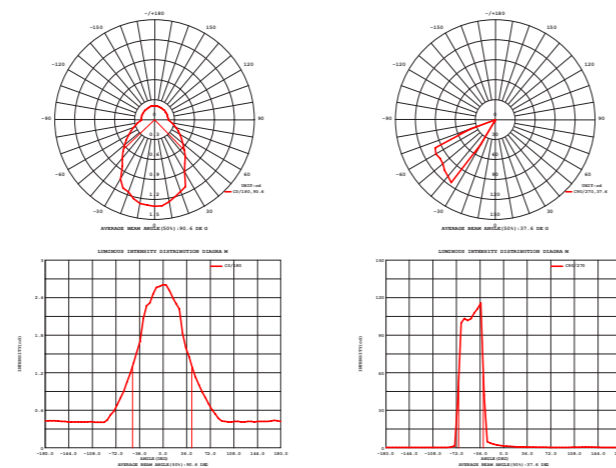

× Modos Instalación-Installation Forms



Con tubo carcasa-Recessed tube housing



76mm



Con pinzas-With clamps



74mm

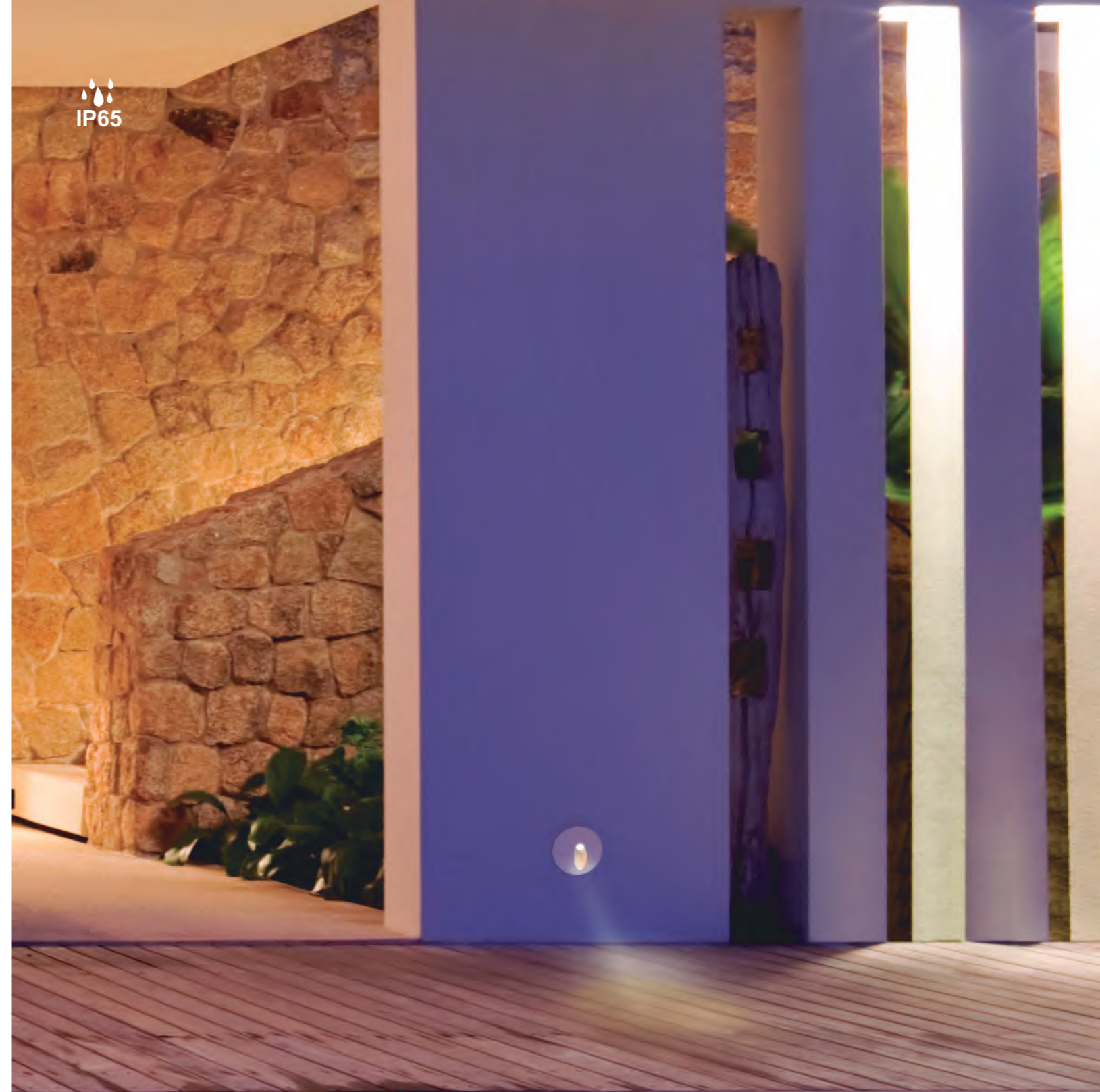

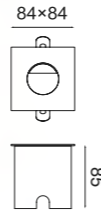
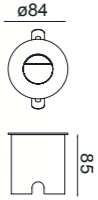

REFERENCE	K	LED WATT	LUMENS	FINISH
7027	3000K	3W	210lm	Gris Oscuro-Dark Grey
7028	3000K	3W	210lm	Negro arena-Sand black
7029	3000K	3W	210lm	Blanco arena-Sand white
7030	3000K	3W	210lm	Gris Oscuro-Dark Grey
7031	3000K	3W	210lm	Negro arena-Sand black
7032	3000K	3W	210lm	Blanco arena-Sand white
200-240V~ 50/60Hz CRI:≥ 80				Aluminio/PC-Aluminium/PC

LUMINOUS INTENSITY DISTRIBUTION DIAGRAM

LUMINOUS INTENSITY DISTRIBUTION DIAGRAM

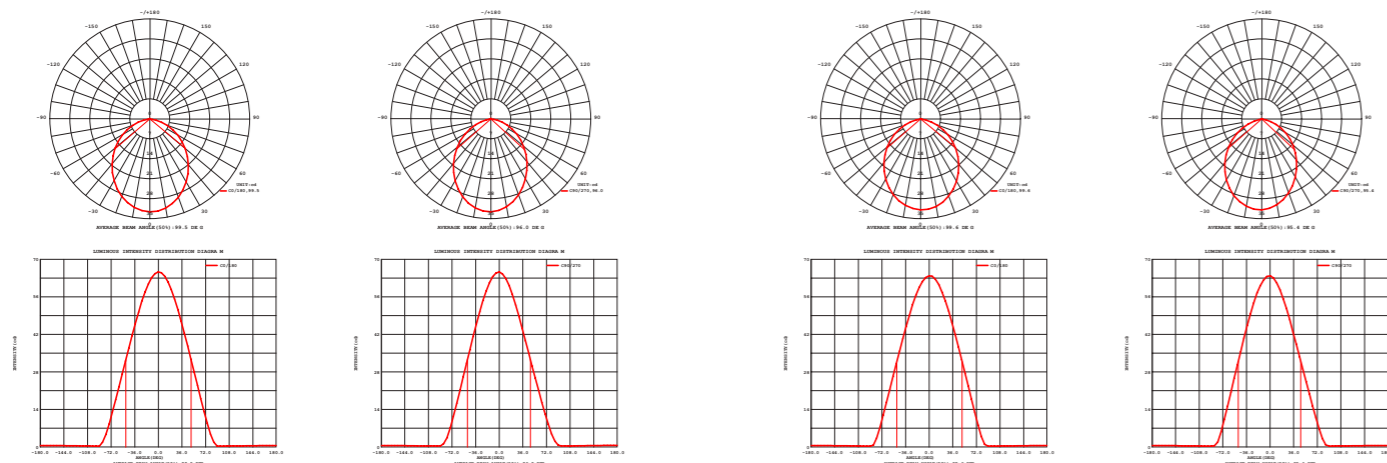

× Modos Instalación-Installation Forms



Con tubo carcasa-Recessed tube housing



76mm



Con pinzas-With clips



74mm

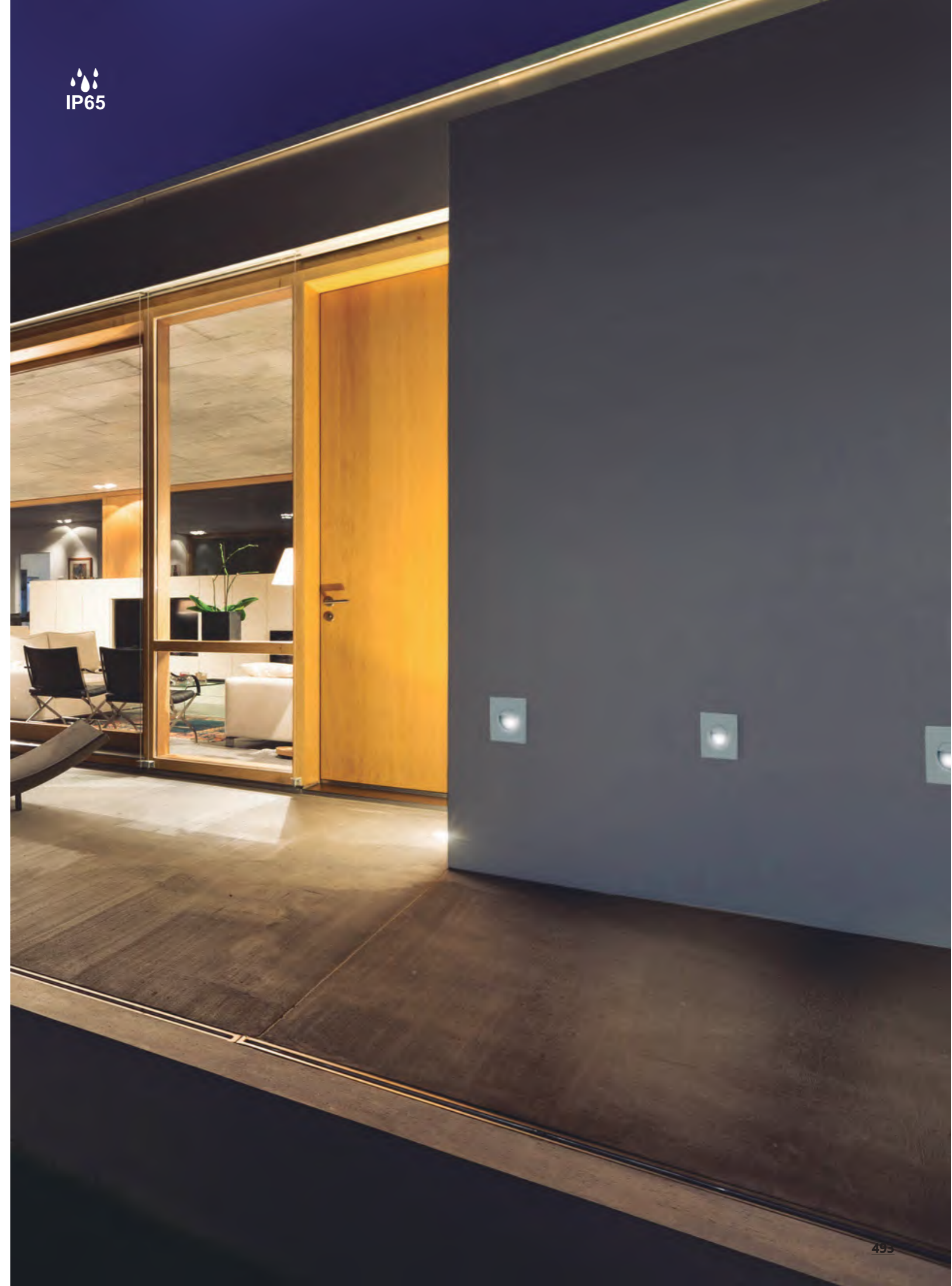

TU0662



TU0663



REFERENCE	OPERATING RATING	VOLTAGE	AMPERE	WIRE SECTION	OUTER CABLE DIAMETER	IP
TU0662	-40°C + 105C	400V AC	17,5A	0.5 mm ² - 1,5 mm ²	3,5 mm-7,0mm; 7mm-10mm	68
TU0663	-40°C + 105C	400V AC	24A	0.5 mm ² - 2,5 mm ²	5 mm-9mm; 9mm-12mm	68

PC-PC PA66 Nylon

PIQUETAS

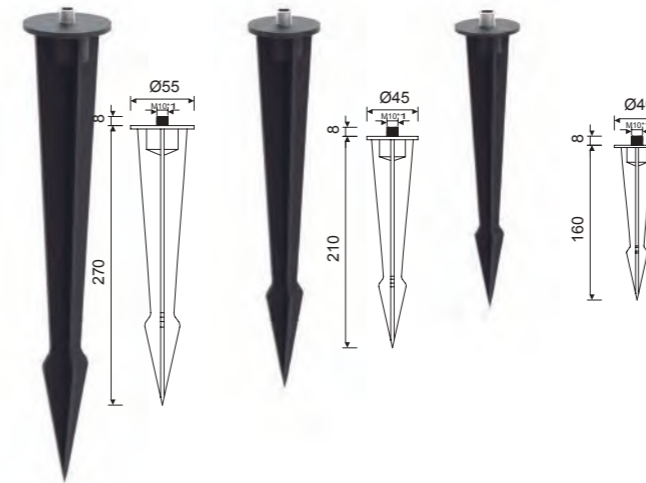

REFERENCE	DESCRIPCIÓN	ACABADO	TAMAÑO
TU0492	Piqueta 16cm	Negro-Black	40×160 mm
TU0652	Piqueta 21cm	Negro-Black	45×210 mm
TU0653	Piqueta 26cm	Negro-Black	55×270 mm

Aluminio-Aluminium

BASE SUJECIÓN/FIXING BASE

TU0494

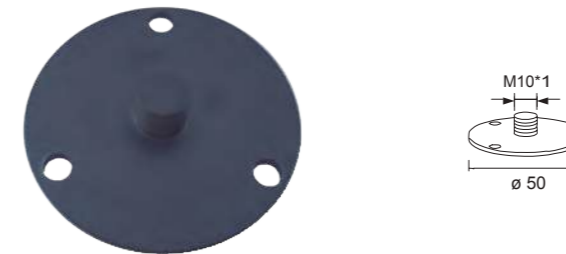

REFERENCE	DESCRIPCIÓN	ACABADO	TAMAÑO
TU0494	Disco para suelo	Negro-Black	ø50 mm

Aluminio-Aluminium

Bombillas Bulbs



LED E14 Bulb

Características

- * Voltaje: AC 220-240V/50Hz 22mA
- * 50,000 hrs. Vida útil
- * Encendido instantáneo con potencia total
- * Perfecta para reemplazar la bombilla incandescente de 40W
- * Baja temperatura al tacto
- * Libre de mercurio, libre de emisión UV & IR
- * Esta bombilla no es idónea para la iluminación de acentuación

Features

- * Voltage: AC 220-240V/50Hz 22mA
- * 50,000hrs long life time
- * Instant start with full bright output flick free
- * Perfect replacement for 40W incandescent bulb
- * Low temperature, safety to touch
- * No UV or IR emission, mercury FREE
- * This bulb is not suitable for accent lighting



2.2W E14 470 Lumen

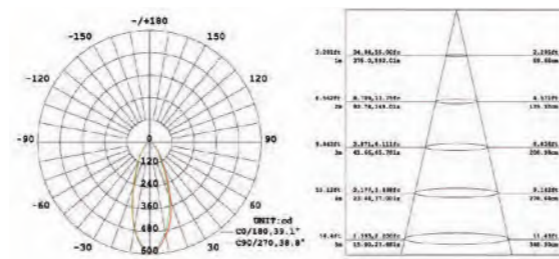

LED E14 Bulb

Características

- * Voltaje: AC 220-240V/50Hz 22mA
- * 50,000 hrs. Vida útil
- * Encendido instantáneo con potencia total
- * Perfecta para reemplazar la bombilla incandescente de 40W
- * Baja temperatura al tacto
- * Libre de mercurio, libre de emisión UV & IR
- * Esta bombilla no es idónea para la iluminación de acentuación

Features

- * Voltage: AC 220-240V/50Hz 22mA
- * 50,000hrs long life time
- * Instant start with full bright output flick free
- * Perfect replacement for 40W incandescent bulb
- * Low temperature, safety to touch
- * No UV or IR emission, mercury FREE
- * This bulb is not suitable for accent lighting



2.2W E14 470 Lumen

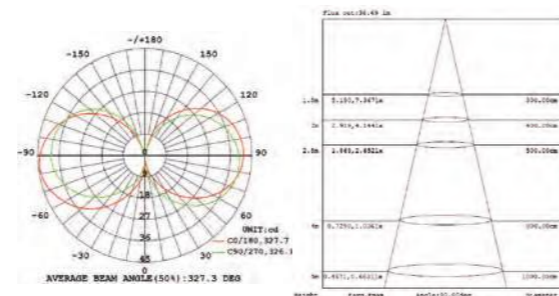

LED E27 bulb

Características

- * Voltaje: AC 220-240V/50Hz 34mA
- * 50,000 hrs. Vida útil
- * Encendido instantáneo con potencia total
- * Perfecta para reemplazar la bombilla incandescente de 60W
- * Baja temperatura al tacto
- * Libre de mercurio, libre de emisión UV & IR
- * Esta bombilla no es idónea para la iluminación de acentuación

Features

- * Voltage: AC 220-240V/50Hz 34mA
- * 50,000hrs long life time
- * Instant start with full bright output flick free
- * Perfect replacement for 60W incandescent bulb
- * Low temperature, safety to touch
- * No UV or IR emission, mercury FREE
- * This bulb is not suitable for accent lighting



3.8W E27 806 Lumen

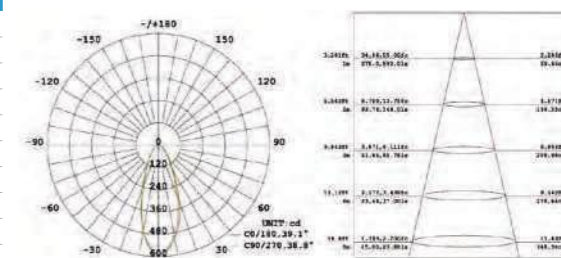
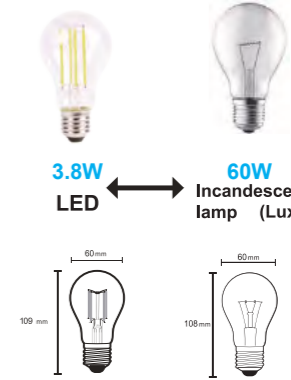

LED E27 bulb

Características

- * Voltaje: AC 220-240V/50Hz 53mA
- * 50,000 hrs. Vida útil
- * Encendido instantáneo con potencia total
- * Perfecta para reemplazar la bombilla incandescente de 100W
- * Baja temperatura al tacto
- * Libre de mercurio, libre de emisión UV & IR
- * Esta bombilla no es idónea para la iluminación de acentuación

Features

- * Voltage: AC 220-240V/50Hz 53mA
- * 50,000hrs long life time
- * Instant start with full bright output flick free
- * Perfect replacement for 100W incandescent bulb
- * Low temperature, safety to touch
- * No UV or IR emission, mercury FREE
- * This bulb is not suitable for accent lighting



7.2W E27 1521 Lumen

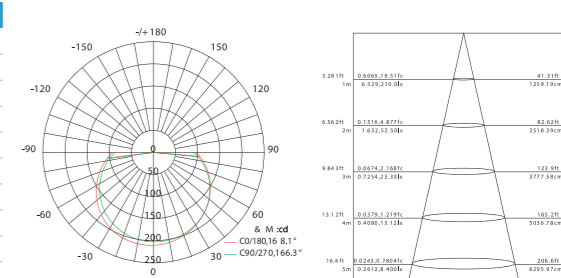

LED E14 Bulb

Características

- * Voltaje: AC 220-240V/50Hz 22mA
- * 50,000 hrs. Vida útil
- * Encendido instantáneo con potencia total
- * Perfecta para reemplazar la bombilla incandescente de 40W
- * Baja temperatura al tacto
- * Libre de mercurio, libre de emisión UV & IR
- * Esta bombilla no es idónea para la iluminación de acentuación

Features

- * Voltage: AC 220-240V/50Hz 22mA
- * 50,000hrs long life time
- * Instant start with full bright output flick free
- * Perfect replacement for 40W incandescent bulb
- * Low temperature, safety to touch
- * No UV or IR emission, mercury FREE
- * This bulb is not suitable for accent lighting



2.2W E14 456 Lumen

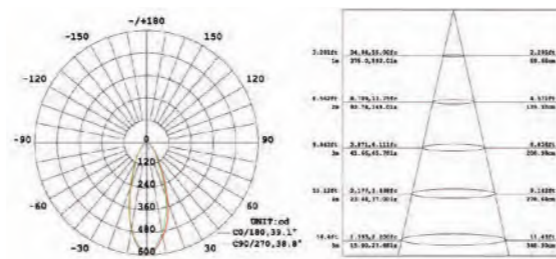
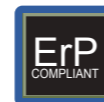

LED E27 bulb

Característica

- * Voltaje: AC 220-240V/50Hz 34mA
- * 50,000 hrs. Vida útil
- * Encendido instantáneo con potencia total
- * Perfecta para reemplazar la bombilla incandescente de 60W
- * Baja temperatura al tacto
- * Libre de mercurio, libre de emisión UV & IR
- * Esta bombilla no es idónea para la iluminación de acentuación

Features

- * Voltage: AC 220-240V/50Hz 34mA
- * 50,000hrs long life time
- * Instant start with full bright output flick free
- * Perfect replacement for 60W incandescent bulb
- * Low temperature, safety to touch
- * No UV or IR emission, mercury FREE
- * This bulb is not suitable for accent lighting



3.8W E27 782 Lumen



Item No.	R09274	R09275
Potencia nominal/Wattage(W)	3.8	4000K
Temperatura de color/CCT(K)	3000K	4000K
Flujo luminoso/Luminous Flux(lm)	782	
Tensión nominal/Voltage(V)	AC 220-240V/50Hz	
Regulable/Dimmable	NO	
CRI	≥80	
Casquillo/Lamp Head	E27	
Ángulo/Beam Angle(deg)	360°	
Material	Cristal/Glass	
Dimensiones/Dimensions(mm)	Ø60*109	

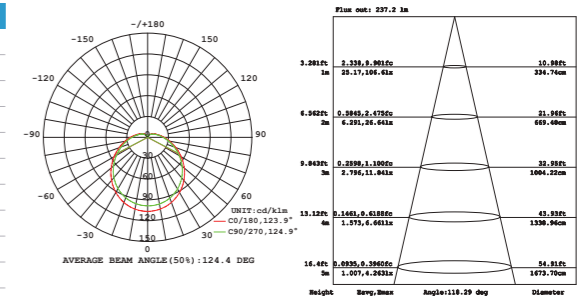

LED E14 Bulb

Características

- * Voltaje: AC 220-240V/50Hz 22mA
- * 50,000 hrs. Vida útil
- * Encendido instantáneo con potencia total
- * Perfecta para reemplazar la bombilla incandescente de 40W
- * Baja temperatura al tacto
- * Libre de mercurio, libre de emisión UV & IR
- * Esta bombilla no es idónea para la iluminación de acentuación

Features

- * Voltage: AC 220-240V/50Hz 22mA
- * 50,000hrs long life time
- * Instant start with full bright output flick free
- * Perfect replacement for 40W incandescent bulb
- * Low temperature, safety to touch
- * No UV or IR emission, mercury FREE
- * This bulb is not suitable for accent lighting



2.2W E14 456 Lumen

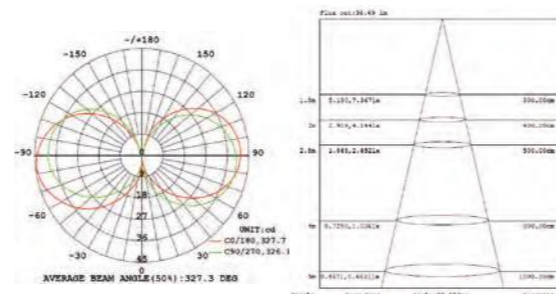
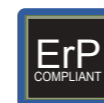

LED E27 bulb

Característica

- * Voltaje: AC 220-240V/50Hz 53mA
- * 50,000 hrs. Vida útil
- * Encendido instantáneo con potencia total
- * Perfecta para reemplazar la bombilla incandescente de 100W
- * Baja temperatura al tacto
- * Libre de mercurio, libre de emisión UV & IR
- * Esta bombilla no es idónea para la iluminación de acentuación

Features

- * Voltage: AC 220-240V/50Hz 53mA
- * 50,000hrs long life time
- * Instant start with full bright output flick free
- * Perfect replacement for 100W incandescent bulb
- * Low temperature, safety to touch
- * No UV or IR emission, mercury FREE
- * This bulb is not suitable for accent lighting



7.2W E27 1475 Lumen



Item No.	R09278	R09279
Potencia nominal/Wattage(W)	7.2	4000K
Temperatura de color/CCT(K)	3000K	4000K
Flujo luminoso/Luminous Flux(lm)	1475	
Tensión nominal/Voltage(V)	AC 220-240V/50Hz	
Regulable/Dimmable	NO	
CRI	≥80	
Casquillo/Lamp Head	E27	
Ángulo/Beam Angle(deg)	360°	
Material	Cristal/Glass	
Dimensiones/Dimensions(mm)	Ø60*109	

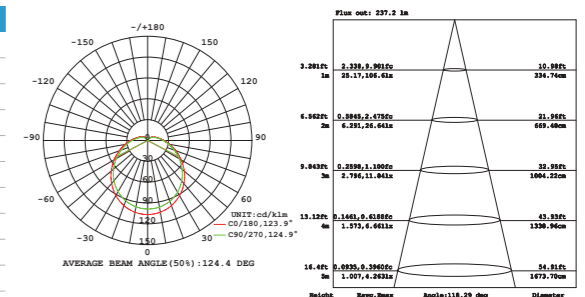

LED E14 bulb

Características

- * Voltaje: AC 220-240V 50/60Hz 35mA
- * 15,000 hrs. Vida útil
- * Encendido instantáneo con potencia total
- * Perfecta para reemplazar la bombilla incandescente de 40W
- * Baja temperatura al tacto
- * Libre de mercurio, libre de emisión UV & IR
- * Esta bombilla no es idónea para la iluminación de acentuación

Features

- * Voltage: AC 220-240V 50/60Hz 35mA
- * 15,000hrs long life time
- * Instant start with full bright output flick free
- * Perfect replacement for 40W incandescent bulb
- * Low temperature, safety to touch
- * No UV or IR emission, mercury FREE
- * This bulb is not suitable for accent lighting



4W E14 470 Lumen

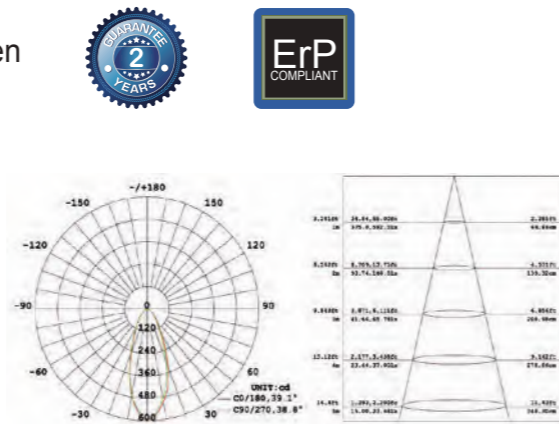
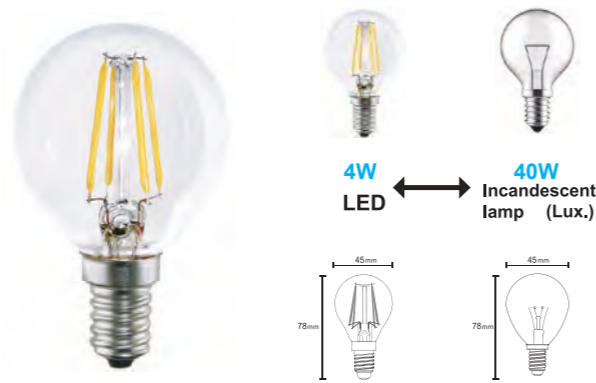

Item No.	R09114
Potencia nominal/Wattage(W)	4
Temperatura de color/CCT(K)	2700K
Flujo luminoso/Luminous Flux(lm)	470
Tensión nominal/Voltage(V)	AC 220-240V 50/60Hz
Regulable/Dimmable	NO
CRI	≥80
Casquillo/Lamp Head	E14
Ángulo/Beam Angle(deg)	360°
Material	Aluminio+Cristal/Aluminum+Glass
Dimensiones/Dimensions(mm)	Ø45*78

LED E14 bulb

Características

- * Voltaje: AC 220-240V/50Hz 55mA
- * 15,000 hrs. Vida útil
- * Encendido instantáneo con potencia total
- * Perfecta para reemplazar la bombilla incandescente de 60W
- * Baja temperatura al tacto
- * Libre de mercurio, libre de emisión UV & IR
- * Esta bombilla no es idónea para la iluminación de acentuación

Features

- * Voltage: AC 220-240V/50Hz 55mA
- * 15,000hrs long life time
- * Instant start with full bright output flick free
- * Perfect replacement for 60W incandescent bulb
- * Low temperature, safety to touch
- * No UV or IR emission, mercury FREE
- * This bulb is not suitable for accent lighting



6.5W E14 800 Lumen

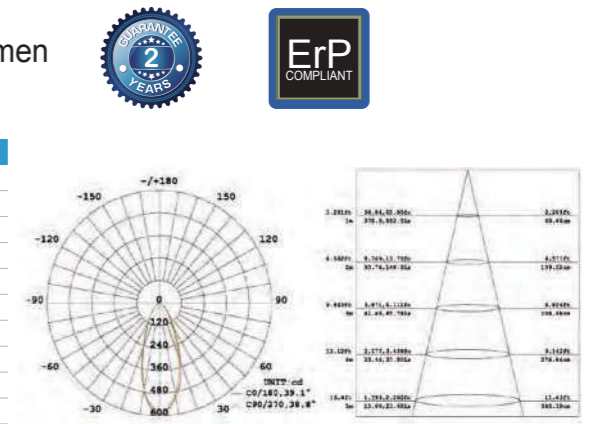

Item No.	R09239	R09240
Potencia nominal/Wattage(W)		6.5
Temperatura de color/CCT(K)	3000K	4000K
Flujo luminoso/Luminous Flux(lm)	790	800
Tensión nominal/Voltage(V)	AC 220-240V/50Hz	
Regulable/Dimmable	NO	
CRI	≥80	
Casquillo/Lamp Head	E14	
Ángulo/Beam Angle(deg)	360°	
Material	Aluminio+Cristal/Aluminum+Glass	
Dimensiones/Dimensions(mm)	Ø45*78	

LED E14 bulb

Características

- * Voltaje: AC 220-240V 50/60Hz 35mA
- * 15,000 hrs. Vida útil
- * Encendido instantáneo con potencia total
- * Perfecta para reemplazar la bombilla incandescente de 40W
- * Baja temperatura al tacto
- * Libre de mercurio, libre de emisión UV & IR
- * Esta bombilla no es idónea para la iluminación de acentuación

Features

- * Voltage: AC 220-240V 50/60Hz 35mA
- * 15,000hrs long life time
- * Instant start with full bright output flick free
- * Perfect replacement for 40W incandescent bulb
- * Low temperature, safety to touch
- * No UV or IR emission, mercury FREE
- * This bulb is not suitable for accent lighting



4W E14 470 Lumen

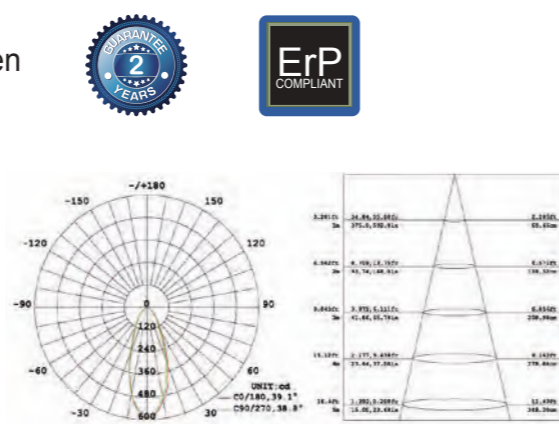

Item No.	R09116
Potencia nominal/Wattage(W)	4
Temperatura de color/CCT(K)	2700K
Flujo luminoso/Luminous Flux(lm)	470
Tensión nominal/Voltage(V)	AC 220-240V 50/60Hz
Regulable/Dimmable	NO
CRI	≥80
Casquillo/Lamp Head	E14
Ángulo/Beam Angle(deg)	360°
Material	Aluminio+Cristal/Aluminum+Glass
Dimensiones/Dimensions(mm)	Ø35*130

LED E14 bulb

Características

- * Voltaje: AC 220-240V 50/60Hz 35mA
- * 15,000 hrs. Vida útil
- * Encendido instantáneo con potencia total
- * Perfecta para reemplazar la bombilla incandescente de 40W
- * Baja temperatura al tacto
- * Libre de mercurio, libre de emisión UV & IR
- * Esta bombilla no es idónea para la iluminación de acentuación

Features

- * Voltage: AC 220-240V 50/60Hz 35mA
- * 15,000hrs long life time
- * Instant start with full bright output flick free
- * Perfect replacement for 40W incandescent bulb
- * Low temperature, safety to touch
- * No UV or IR emission, mercury FREE
- * This bulb is not suitable for accent lighting



4W E14 470 Lumen

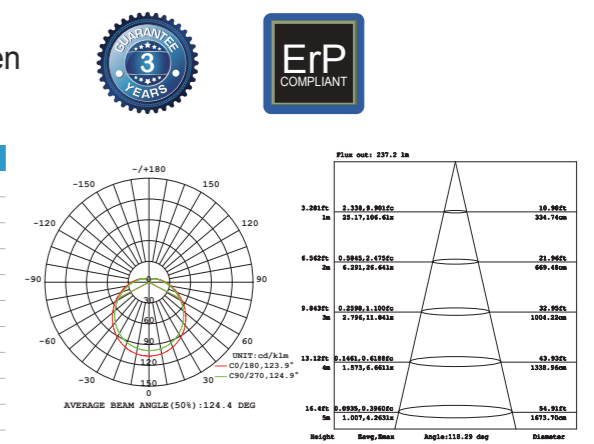

Item No.	R09241	R09242
Potencia nominal/Wattage(W)		4
Temperatura de color/CCT(K)	3000K	4000K
Flujo luminoso/Luminous Flux(lm)	470	485
Tensión nominal/Voltage(V)	AC 220-240V 50/60Hz	
Regulable/Dimmable	NO	
CRI	≥80	
Casquillo/Lamp Head	E14	
Ángulo/Beam Angle(deg)	360°	
Material	Aluminio+PC+Cristal/Aluminum+PC+Glass	
Dimensiones/Dimensions(mm)	Ø35*95	

LED E14 bulb

Características

- * Voltaje: AC 220-240V 50/60Hz 35mA
- * 15,000 hrs. Vida útil
- * Encendido instantáneo con potencia total
- * Perfecta para reemplazar la bombilla incandescente de 40W
- * Baja temperatura al tacto
- * Libre de mercurio, libre de emisión UV & IR
- * Esta bombilla no es idónea para la iluminación de acentuación

Features

- * Voltage: AC 220-240V 50/60Hz 35mA
- * 15,000hrs long life time
- * Instant start with full bright output flick free
- * Perfect replacement for 40W incandescent bulb
- * Low temperature, safety to touch
- * No UV or IR emission, mercury FREE
- * This bulb is not suitable for accent lighting



4W E14 470 Lumen

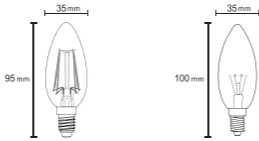

Item No.	R09115
Potencia nominal/Wattage(W)	4
Temperatura de color/CCT(K)	2700K
Flujo luminoso/Luminous Flux(lm)	470
Tensión nominal/Voltage(V)	AC 220-240V 50/60Hz
Regulable/Dimmable	NO
CRI	≥80
Casquillo/Lamp Head	E14
Ángulo/Beam Angle(deg)	360°
Material	Aluminio+Crystal/Aluminum+Glass
Dimensiones/Dimensions(mm)	35*95

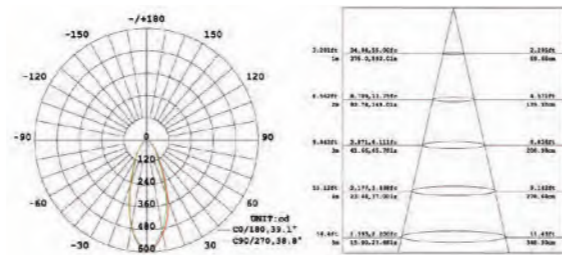

LED E27 bulb

Características

- * Voltaje: AC 220-240V 50/60Hz 55mA
- * 15,000 hrs. Vida útil
- * Encendido instantáneo con potencia total
- * Perfecta para reemplazar la bombilla incandescente de 75W
- * Baja temperatura al tacto
- * Libre de mercurio, libre de emisión UV & IR
- * Esta bombilla no es idónea para la iluminación de acentuación

Features

- * Voltage: AC 220-240V 50/60Hz 55mA
- * 15,000hrs long life time
- * Instant start with full bright output flick free
- * Perfect replacement for 75W incandescent bulb
- * Low temperature, safety to touch
- * No UV or IR emission, mercury FREE
- * This bulb is not suitable for accent lighting



10W E27 1050 Lumen

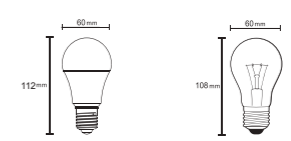
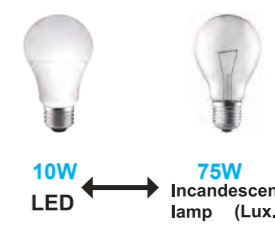

Item No.	R09133	R09215	R09134
Potencia nominal/Wattage(W)		10	
Temperatura de color/CCT(K)	3000K	4000K	5000K
Flujo luminoso/Luminous Flux(lm)	1055	1080	1100
Tensión nominal/Voltage(V)	AC 220-240V 50/60Hz		
Regulable/Dimmable	NO		
CRI	≥80		
Casquillo/Lamp Head	E27		
Ángulo/Beam Angle(deg)	320°		
Material	Aluminio+PC/Aluminum+PC		
Dimensiones/Dimensions(mm)	Ø60*112		

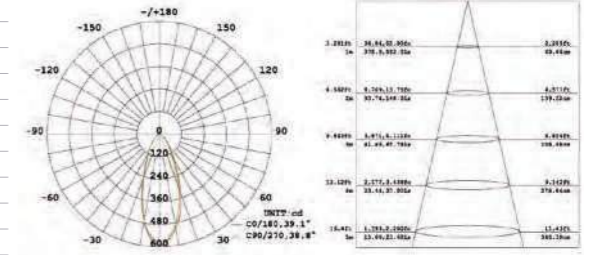

LED E27 bulb

Características

- * Voltaje: AC 220-240V 50/60Hz 75mA
- * 15,000 hrs. Vida útil
- * Encendido instantáneo con potencia total
- * Perfecta para reemplazar la bombilla incandescente de 75W
- * Baja temperatura al tacto
- * Libre de mercurio, libre de emisión UV & IR
- * Esta bombilla no es idónea para la iluminación de acentuación

Features

- * Voltage: AC 220-240V 50/60Hz 75mA
- * 15,000hrs long life time
- * Instant start with full bright output flick free
- * Perfect replacement for 75W incandescent bulb
- * Low temperature, safety to touch
- * No UV or IR emission, mercury FREE
- * This bulb is not suitable for accent lighting



9W E27 1055 Lumen

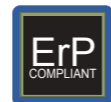
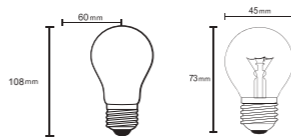

Item No.	R09234	R09235
Potencia nominal/Wattage(W)		9
Temperatura de color/CCT(K)	3000K	4000K
Flujo luminoso/Luminous Flux(lm)	1055	1090
Tensión nominal/Voltage(V)	AC 220-240V 50/60Hz	
Regulable/Dimmable	NO	
CRI	≥80	
Casquillo/Lamp Head	E27	
Ángulo/Beam Angle(deg)	360°	
Material	Cristal+PC+Metal/Glass+PC+Metal	
Dimensiones/Dimensions(mm)	Ø60*108	

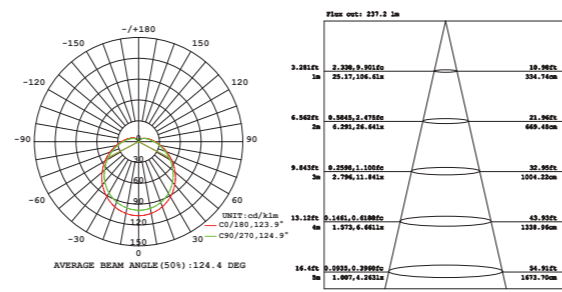

LED E27 bulb

Características

- * Voltaje: AC 220-240V 50/60Hz 65mA
- * 15,000 hrs. Vida útil
- * Encendido instantáneo con potencia total
- * Perfecta para reemplazar la bombilla incandescente de 100W
- * Baja temperatura al tacto
- * Libre de mercurio, libre de emisión UV & IR
- * Esta bombilla no es idónea para la iluminación de acentuación

Features

- * Voltage: AC 220-240V 50/60Hz 65mA
- * 15,000hrs long life time
- * Instant start with full bright output flick free
- * Perfect replacement for 100W incandescent bulb
- * Low temperature, safety to touch
- * No UV or IR emission, mercury FREE
- * This bulb is not suitable for accent lighting



12W E27 1520 Lumen DIMMABLE

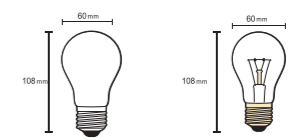

Item No.	R09251	R09252	R09253
Potencia nominal/Wattage(W)		12	
Temperatura de color/CCT(K)	2700K	3000K	4000K
Flujo luminoso/Luminous Flux(lm)	1440	1480	1520
Tensión nominal/Voltage(V)	AC 220-240V 50/60Hz		
Regulable/Dimmable	YES		
CRI	≥80		
Casquillo/Lamp Head	E27		
Ángulo/Beam Angle(deg)	360°		
Material	Aluminio+Crystal/Aluminum+Glass		
Dimensiones/Dimensions(mm)	Ø60*108		

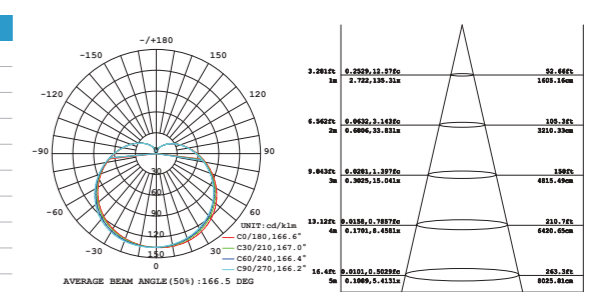

LED E27 bulb

Características

- Voltaje: AC 220-240V 50/60Hz 56mA
- 15,000 hrs. Vida útil
- Encendido instantáneo con potencia total
- Perfecta para reemplazar la bombilla incandescente de 60W
- Baja temperatura al tacto
- Libre de mercurio, libre de emisión UV & IR
- Esta bombilla no es idónea para la iluminación de acentuación

Features

- Voltage: AC 220-240V 50/60Hz 56mA
- 15,000hrs long life time
- Instant start with full bright output flick free
- Perfect replacement for 60W incandescent bulb
- Low temperature, safety to touch
- No UV or IR emission, mercury FREE
- This bulb is not suitable for accent lighting



7W E27 800 Lumen

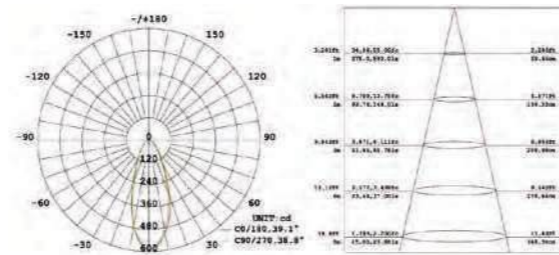
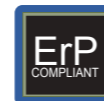
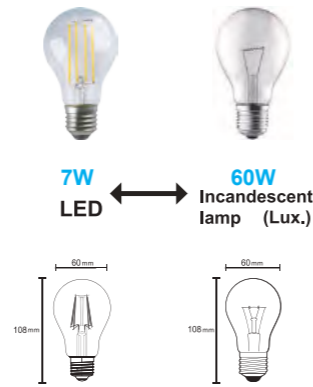

Item No.	R09131	R09250	R09211
Potencia nominal/Wattage(W)		7	
Temperatura de color/CCT(K)	2700K	3000K	4000K
Flujo luminoso/Luminous Flux(lm)		800	
Tensión nominal/Voltage(V)	AC 220-240V 50/60Hz		
Regulable/Dimmable	NO		
CRI	≥80		
Casquillo/Lamp Head	E27		
Ángulo/Beam Angle(deg)	360°		
Material	Cristal / Glass		
Dimensiones/Dimensions(mm)	Ø60*108		

LED E27 bulb

Características

- Voltaje: AC 220-240V/50Hz 55mA
- 15,000 hrs. Vida útil
- Encendido instantáneo con potencia total
- Perfecta para reemplazar la bombilla incandescente de 60W
- Baja temperatura al tacto
- Libre de mercurio, libre de emisión UV & IR
- Esta bombilla no es idónea para la iluminación de acentuación

Features

- Voltage: AC 220-240V/50Hz 55mA
- 15,000hrs long life time
- Instant start with full bright output flick free
- Perfect replacement for 60W incandescent bulb
- Low temperature, safety to touch
- No UV or IR emission, mercury FREE
- This bulb is not suitable for accent lighting



6.5W E27 800 Lumen

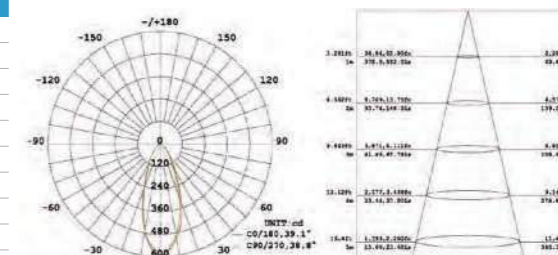
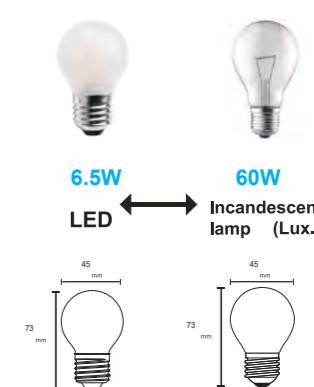

Item No.	R09237	R09238
Potencia nominal/Wattage(W)		6.5
Temperatura de color/CCT(K)	3000K	4000K
Flujo luminoso/Luminous Flux(lm)	790	800
Tensión nominal/Voltage(V)	AC 220-240V/50Hz	
Regulable/Dimmable	NO	
CRI	≥80	
Casquillo/Lamp Head	E27	
Ángulo/Beam Angle(deg)	360°	
Material	Aluminio+Cristal/Aluminum+Glass	
Dimensiones/Dimensions(mm)	Ø45*73	

LED E27 bulb

Características

- Voltaje: AC 220-240V 50/60Hz 35mA
- 15,000 hrs. Vida útil
- Encendido instantáneo con potencia total
- Perfecta para reemplazar la bombilla incandescente de 40W
- Baja temperatura al tacto
- Libre de mercurio, libre de emisión UV & IR
- Esta bombilla no es idónea para la iluminación de acentuación

Features

- Voltage: AC 220-240V 50/60Hz 35mA
- 15,000hrs long life time
- Instant start with full bright output flick free
- Perfect replacement for 40W incandescent bulb
- Low temperature, safety to touch
- No UV or IR emission, mercury FREE
- This bulb is not suitable for accent lighting



4W E27 470 Lumen

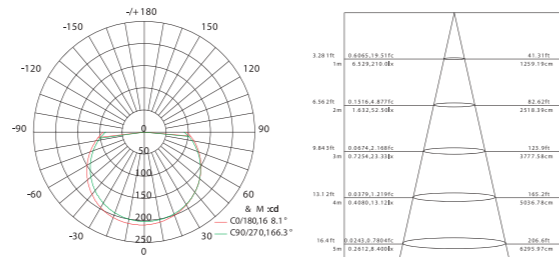
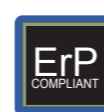
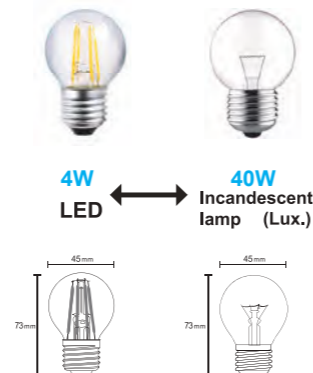

Item No.	R09132
Potencia nominal/Wattage(W)	4
Temperatura de color/CCT(K)	2700K
Flujo luminoso/Luminous Flux(lm)	470
Tensión nominal/Voltage(V)	AC 220-240V 50/60Hz
Regulable/Dimmable	NO
CRI	≥80
Casquillo/Lamp Head	E27
Ángulo/Beam Angle(deg)	360°
Material	Cristal / Glass
Dimensiones/Dimensions(mm)	Ø45*73

LED E27 bulb

Características

- Voltaje: AC 220-240V 50/60Hz 72mA
- 15,000 hrs. Vida útil
- Encendido instantáneo con potencia total
- Perfecta para reemplazar la bombilla incandescente de 125W
- Baja temperatura al tacto
- Libre de mercurio, libre de emisión UV & IR
- Esta bombilla no es idónea para la iluminación de acentuación

Features

- Voltage: AC 220-240V 50/60Hz 72mA
- 15,000hrs long life time
- Instant start with full bright output flick free
- Perfect replacement for 125W incandescent bulb
- Low temperature, safety to touch
- No UV or IR emission, mercury FREE
- This bulb is not suitable for accent lighting



14W E27 1510 Lumen

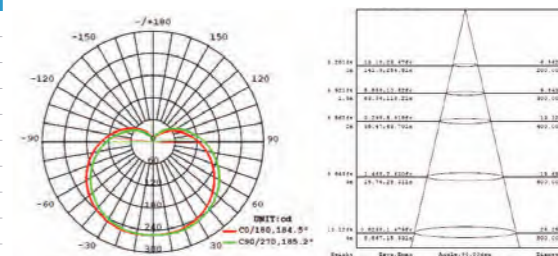

Item No.	R09139	R09140
Potencia nominal/Wattage(W)		14
Temperatura de color/CCT(K)	3000K	4000K
Flujo luminoso/Luminous Flux(lm)	1460	1510
Tensión nominal/Voltage(V)	AC 220-240V 50/60Hz	
Regulable/Dimmable	NO	
CRI	≥80	
Casquillo/Lamp Head	E27	
Ángulo/Beam Angle(deg)	240°	
Material	PBT+cristal/glass	
Dimensiones/Dimensions(mm)	Ø60*120	

LED E27 bulb

Características

- * Voltaje: AC 220-240V 50/60Hz 56mA
- * 15,000 hrs. Vida útil
- * Encendido instantáneo con potencia total
- * Perfecta para reemplazar la bombilla incandescente de 60W
- * Baja temperatura al tacto
- * Libre de mercurio, libre de emisión UV & IR
- * Esta bombilla no es idónea para la iluminación de acentuación

Features

- * Voltage: AC 220-240V 50/60Hz 56mA
- * 15,000hrs long life time
- * Instant start with full bright output flick free
- * Perfect replacement for 60W incandescent bulb
- * Low temperature, safety to touch
- * No UV or IR emission, mercury FREE
- * This bulb is not suitable for accent lighting



6.5W E27 720 Lumen
G95

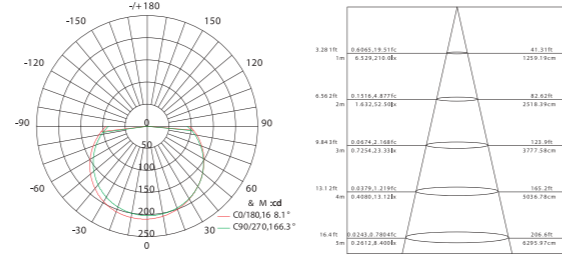
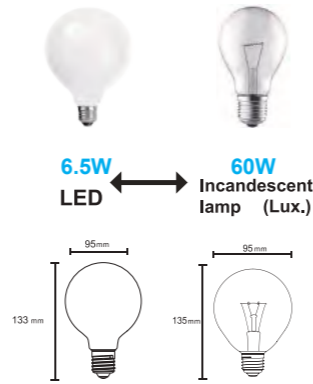

Item No.	R09244	R09245
Potencia nominal/Wattage(W)	6.5	
Temperatura de color/CCT(K)	3000K	4000K
Flujo luminoso/Luminous Flux(lm)	720	740
Tensión nominal/Voltage(V)	AC 220-240V 50/60Hz	
Regulable/Dimmable	NO	
CRI	≥80	
Casquillo/Lamp Head	E27	
Ángulo/Beam Angle(deg)	360°	
Material	Aluminio+Glass Lens/Aluminum+Glass Lens	
Dimensiones/Dimensions(mm)	Ø95*133	

LED E27 bulb

Características

- * Voltaje: AC 220-240V 50/60Hz 56mA
- * 15,000 hrs. Vida útil
- * Encendido instantáneo con potencia total
- * Perfecta para reemplazar la bombilla incandescente de 60W
- * Baja temperatura al tacto
- * Libre de mercurio, libre de emisión UV & IR
- * Esta bombilla no es idónea para la iluminación de acentuación

Features

- * Voltage: AC 220-240V 50/60Hz 56mA
- * 15,000hrs long life time
- * Instant start with full bright output flick free
- * Perfect replacement for 60W incandescent bulb
- * Low temperature, safety to touch
- * No UV or IR emission, mercury FREE
- * This bulb is not suitable for accent lighting



6.5W E27 650 Lumen
G95

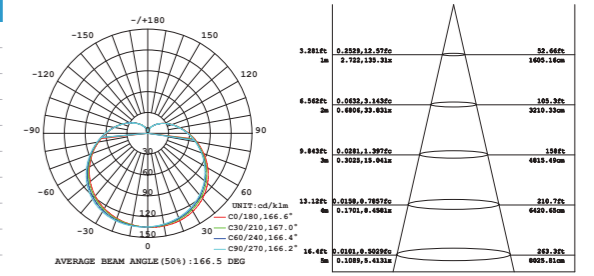
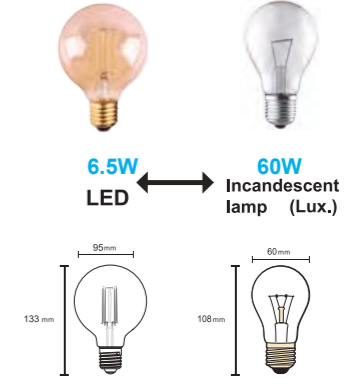

Item No.	R09229
Potencia nominal/Wattage(W)	6.5
Temperatura de color/CCT(K)	2200K
Flujo luminoso/Luminous Flux(lm)	650
Tensión nominal/Voltage(V)	AC 220-240V 50/60Hz
Regulable/Dimmable	NO
CRI	≥80
Casquillo/Lamp Head	E27
Ángulo/Beam Angle(deg)	360°
Material	Aluminio+Cristal/Aluminum+Glass
Dimensiones/Dimensions(mm)	Ø95*133

LED E27 bulb

Características

- * Voltaje: AC 220-240V 50/60Hz 45mA
- * 15,000 hrs. Vida útil
- * Encendido instantáneo con potencia total
- * Perfecta para reemplazar la bombilla incandescente de 60W
- * Baja temperatura al tacto
- * Libre de mercurio, libre de emisión UV & IR
- * Esta bombilla no es idónea para la iluminación de acentuación

Features

- * Voltage: AC 220-240V 50/60Hz 45mA
- * 15,000hrs long life time
- * Instant start with full bright output flick free
- * Perfect replacement for 60W incandescent bulb
- * Low temperature, safety to touch
- * No UV or IR emission, mercury FREE
- * This bulb is not suitable for accent lighting



8W E27 720 Lumen
G95
Dimmable

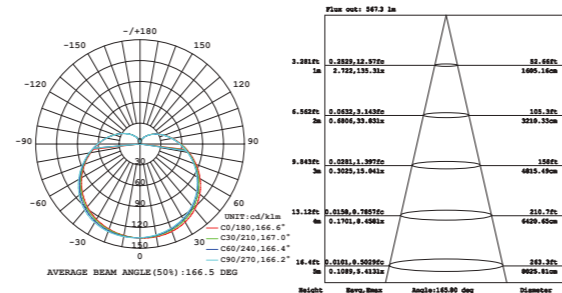
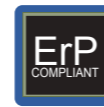
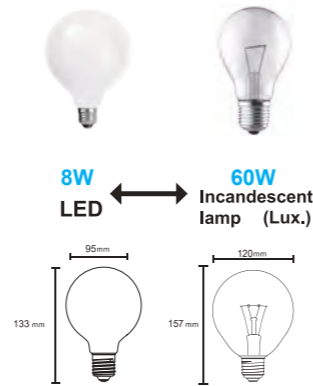

Item No.	R09246
Potencia nominal/Wattage(W)	8
Temperatura de color/CCT(K)	3000K
Flujo luminoso/Luminous Flux(lm)	720
Tensión nominal/Voltage(V)	AC 220-240V 50/60Hz
Regulable/Dimmable	YES
CRI	≥80
Casquillo/Lamp Head	E27
Ángulo/Beam Angle(deg)	360°
Material	Aluminio+Cristal/Aluminum+Glass
Dimensiones/Dimensions(mm)	Ø95*133

LED E27 bulb

Características

- * Voltaje: AC 220-240V 50/60Hz 56mA
- * 15,000 hrs. Vida útil
- * Encendido instantáneo con potencia total
- * Perfecta para reemplazar la bombilla incandescente de 60W
- * Baja temperatura al tacto
- * Libre de mercurio, libre de emisión UV & IR
- * Esta bombilla no es idónea para la iluminación de acentuación

Features

- * Voltage: AC 220-240V 50/60Hz 56mA
- * 15,000hrs long life time
- * Instant start with full bright output flick free
- * Perfect replacement for 60W incandescent bulb
- * Low temperature, safety to touch
- * No UV or IR emission, mercury FREE
- * This bulb is not suitable for accent lighting



6.5W E27 650 Lumen
G125

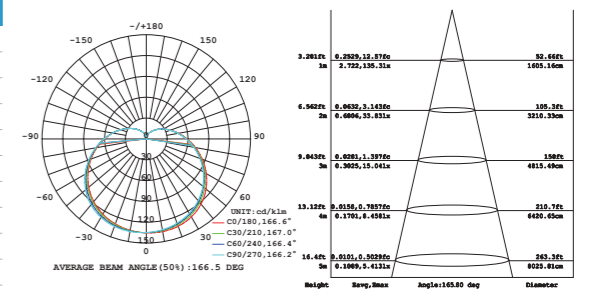
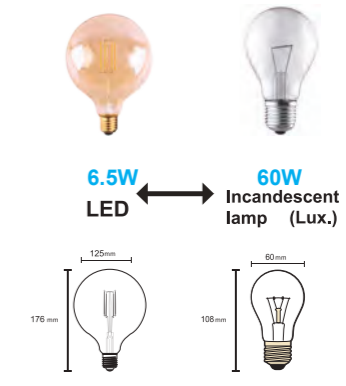

Item No.	R09230
Potencia nominal/Wattage(W)	6.5
Temperatura de color/CCT(K)	2200K
Flujo luminoso/Luminous Flux(lm)	650
Tensión nominal/Voltage(V)	AC 220-240V 50/60Hz
Regulable/Dimmable	NO
CRI	≥80
Casquillo/Lamp Head	E27
Ángulo/Beam Angle(deg)	360°
Material	Aluminio+Cristal/Aluminum+Glass
Dimensiones/Dimensions(mm)	Ø125*176

LED E27 ST64 bulb

Características

- * Voltaje: AC 220-240V 50/60Hz 45mA
- * 15,000 hrs. Vida útil
- * Encendido instantáneo con potencia total
- * Perfecta para reemplazar la bombilla incandescente de 60W
- * Baja temperatura al tacto
- * Libre de mercurio, libre de emisión UV & IR
- * Esta bombilla no es idónea para la iluminación de acentuación

Features

- * Voltage: AC 220-240V 50/60Hz 45mA
- * 15,000hrs long life time
- * Instant start with full bright output flick free
- * Perfect replacement for 60W incandescent bulb
- * Low temperature, safety to touch
- * No UV or IR emission, mercury FREE
- * This bulb is not suitable for accent lighting



8W E27 800 Lumen
ST64
Dimmable

Item No.	R09206
Potencia nominal/Wattage(W)	8
Temperatura de color/CCT(K)	2200K
Flujo luminoso/Luminous Flux(lm)	800
Tensión nominal/Voltage(V)	AC 220-240V 50/60Hz
Regulable/Dimmable	YES
CRI	≥80
Casquillo/Lamp Head	E27
Ángulo/Beam Angle(deg)	360°
Material	Aluminio+Cristal/Aluminum+Glass
Dimensiones/Dimensions(mm)	Ø64*142

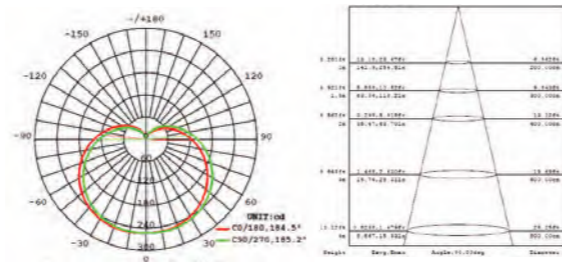

LED E27 G95 bulb

Características

- * Voltaje: AC 220-240V 50/60Hz 45mA
- * 15,000 hrs. Vida útil
- * Encendido instantáneo con potencia total
- * Perfecta para reemplazar la bombilla incandescente de 60W
- * Baja temperatura al tacto
- * Libre de mercurio, libre de emisión UV & IR
- * Esta bombilla no es idónea para la iluminación de acentuación

Features

- * Voltage: AC 220-240V 50/60Hz 45mA
- * 15,000hrs long life time
- * Instant start with full bright output flick free
- * Perfect replacement for 60W incandescent bulb
- * Low temperature, safety to touch
- * No UV or IR emission, mercury FREE
- * This bulb is not suitable for accent lighting



8W E27 800 Lumen
G95
Dimmable

Item No.	R09204
Potencia nominal/Wattage(W)	8
Temperatura de color/CCT(K)	2200K
Flujo luminoso/Luminous Flux(lm)	800
Tensión nominal/Voltage(V)	AC 220-240V 50/60Hz
Regulable/Dimmable	YES
CRI	≥80
Casquillo/Lamp Head	E27
Ángulo/Beam Angle(deg)	360°
Material	Aluminio+Cristal/Aluminum+Glass
Dimensiones/Dimensions(mm)	Ø95*135

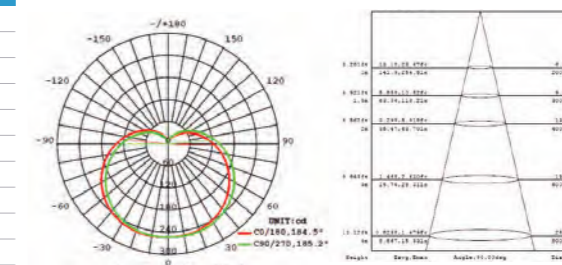
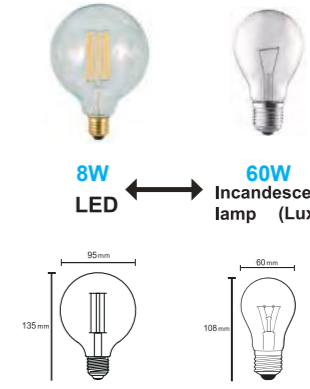

LED E27 bulb

Características

- * Voltaje: AC 220-240V 50/60Hz 56mA
- * 15,000 hrs. Vida útil
- * Encendido instantáneo con potencia total
- * Perfecta para reemplazar la bombilla incandescente de 60W
- * Baja temperatura al tacto
- * Libre de mercurio, libre de emisión UV & IR
- * Esta bombilla no es idónea para la iluminación de acentuación

Features

- * Voltage: AC 220-240V 50/60Hz 56mA
- * 15,000hrs long life time
- * Instant start with full bright output flick free
- * Perfect replacement for 60W incandescent bulb
- * Low temperature, safety to touch
- * No UV or IR emission, mercury FREE
- * This bulb is not suitable for accent lighting



6.5W E27 650 Lumen
ST64

Item No.	R09228
Potencia nominal/Wattage(W)	6.5
Temperatura de color/CCT(K)	2200K
Flujo luminoso/Luminous Flux(lm)	650
Tensión nominal/Voltage(V)	AC 220-240V 50/60Hz
Regulable/Dimmable	NO
CRI	≥80
Casquillo/Lamp Head	E27
Ángulo/Beam Angle(deg)	360°
Material	Aluminio+Cristal/Aluminum+Glass
Dimensiones/Dimensions(mm)	Ø64*138

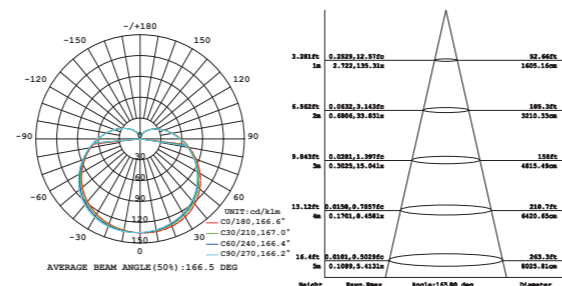
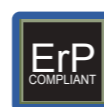
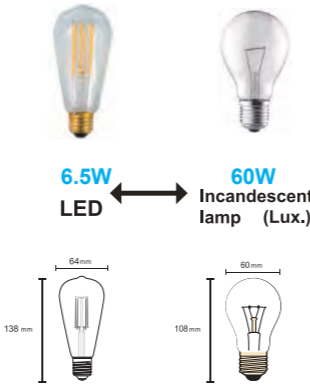

LED E27 G125 bulb

Características

- * Voltaje: AC 220-240V 50/60Hz 45mA
- * 15,000 hrs. Vida útil
- * Encendido instantáneo con potencia total
- * Perfecta para reemplazar la bombilla incandescente de 60W
- * Baja temperatura al tacto
- * Libre de mercurio, libre de emisión UV & IR
- * Esta bombilla no es idónea para la iluminación de acentuación

Features

- * Voltage: AC 220-240V 50/60Hz 45mA
- * 15,000hrs long life time
- * Instant start with full bright output flick free
- * Perfect replacement for 60W incandescent bulb
- * Low temperature, safety to touch
- * No UV or IR emission, mercury FREE
- * This bulb is not suitable for accent lighting



8W E27 800 Lumen
G125
Dimmable

Item No.	R09205
Potencia nominal/Wattage(W)	8
Temperatura de color/CCT(K)	2200K
Flujo luminoso/Luminous Flux(lm)	800
Tensión nominal/Voltage(V)	AC 220-240V 50/60Hz
Regulable/Dimmable	YES
CRI	≥80
Casquillo/Lamp Head	E27
Ángulo/Beam Angle(deg)	360°
Material	Aluminio+Cristal/Aluminum+Glass
Dimensiones/Dimensions(mm)	Ø125*170

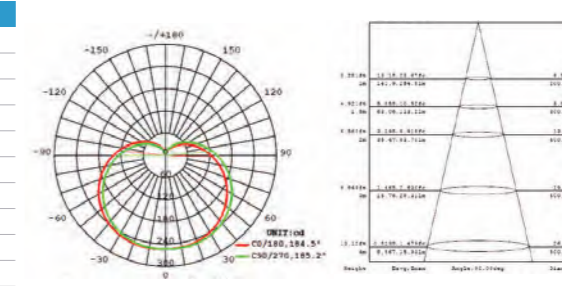
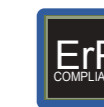
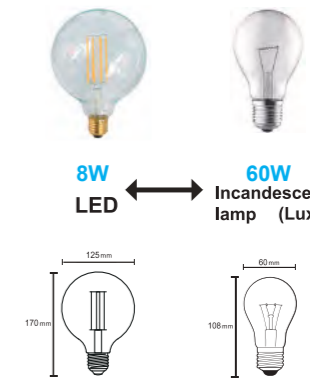

LED E27 T30 bulb

Características

- * Voltaje: AC 220-240V 50/60Hz 430mA
- * 20,000 hrs. Vida útil
- * Encendido instantáneo con potencia total
- * Perfecta para reemplazar la bombilla incandescente de 55W
- * Baja temperatura al tacto
- * Libre de mercurio, libre de emisión UV & IR
- * Esta bombilla no es idónea para la iluminación de acentuación

Features

- * Voltage: AC 220-240V 50/60Hz 430mA
- * 20,000hrs long life time
- * Instant start with full bright output flick free
- * Perfect replacement for 55W incandescent bulb
- * Low temperature, safety to touch
- * No UV or IR emission, mercury FREE
- * This bulb is not suitable for accent lighting

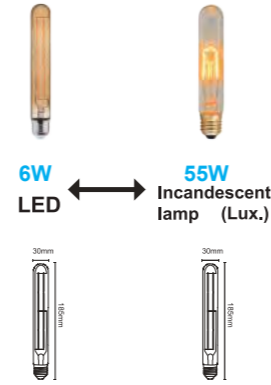

6W E27 575 Lumen
T30



Item No.	R09233
Potencia nominal/Wattage(W)	6
Temperatura de color/CCT(K)	2400K
Flujo luminoso/Luminous Flux(lm)	575
Tensión nominal/Voltage(V)	AC 220-240V 50/60Hz
Regulable/Dimmable	NO
CRI	≥80
Casquillo/Lamp Head	E27
Ángulo/Beam Angle(deg)	360°
Material	Aluminio+Cristal/Aluminum+Glass
Dimensiones/Dimensions(mm)	Ø30*185

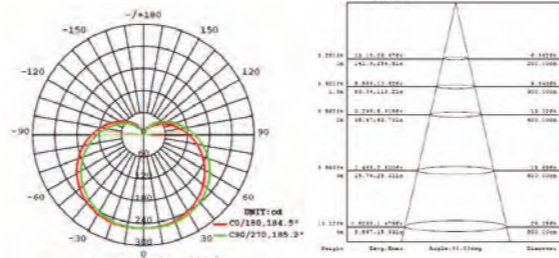

LED E27 bulb

Características

- * Voltaje: AC 220-240V 50/60Hz 60mA
- * 25,000 hrs. Vida útil
- * Encendido instantáneo con potencia total
- * Perfecta para reemplazar la bombilla incandescente de 140W
- * Baja temperatura al tacto
- * Libre de mercurio, libre de emisión UV & IR
- * Esta bombilla no es idónea para la iluminación de acentuación

Features

- * Voltage: AC 220-240V 50/60Hz 60mA
- * 25,000hrs long life time
- * Instant start with full bright output flick free
- * Perfect replacement for 140W incandescent bulb
- * Low temperature, safety to touch
- * No UV or IR emission, mercury FREE
- * This bulb is not suitable for accent lighting

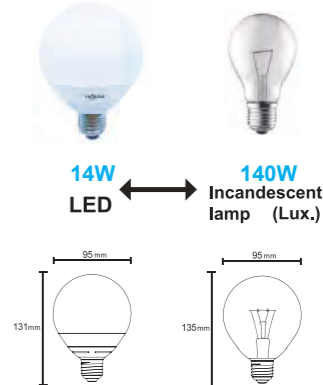

14W E27 1309 Lumen
G95



Item No.	R09122	R09123
Potencia nominal/Wattage(W)	14	
Temperatura de color/CCT(K)	3000K	5000K
Flujo luminoso/Luminous Flux(lm)	1259	1309
Tensión nominal/Voltage(V)	AC 220-240V 50/60Hz	
Regulable/Dimmable	NO	
CRI	≥80	
Casquillo/Lamp Head	E27	
Ángulo/Beam Angle(deg)	180°	
Material	Aluminio+PC/Aluminum+PC	
Dimensiones/Dimensions(mm)	Ø95*131	

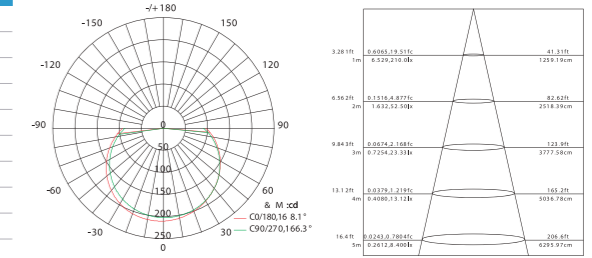

LED E27 T30 bulb

Características

- * Voltaje: AC 220-240V 50/60Hz 430mA
- * 20,000 hrs. Vida útil
- * Encendido instantáneo con potencia total
- * Perfecta para reemplazar la bombilla incandescente de 70W
- * Baja temperatura al tacto
- * Libre de mercurio, libre de emisión UV & IR
- * Esta bombilla no es idónea para la iluminación de acentuación

Features

- * Voltage: AC 220-240V 50/60Hz 430mA
- * 20,000hrs long life time
- * Instant start with full bright output flick free
- * Perfect replacement for 70W incandescent bulb
- * Low temperature, safety to touch
- * No UV or IR emission, mercury FREE
- * This bulb is not suitable for accent lighting

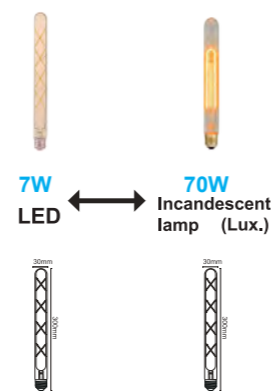

7W E27 660 Lumen
T30



Item No.	R09232
Potencia nominal/Wattage(W)	7
Temperatura de color/CCT(K)	2400K
Flujo luminoso/Luminous Flux(lm)	660
Tensión nominal/Voltage(V)	AC 220-240V 50/60Hz
Regulable/Dimmable	NO
CRI	≥80
Casquillo/Lamp Head	E27
Ángulo/Beam Angle(deg)	360°
Material	Aluminio+Cristal/Aluminum+Glass
Dimensiones/Dimensions(mm)	Ø30*300

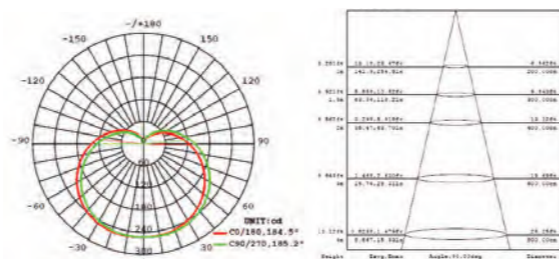

LED E27 bulb

Características

- * Voltaje: AC 220-240V 50/60Hz 165mA
- * 15,000 hrs. Vida útil
- * Encendido instantáneo con potencia total
- * Perfecta para reemplazar la bombilla incandescente de 175W
- * Baja temperatura al tacto
- * Libre de mercurio, libre de emisión UV & IR
- * Esta bombilla no es idónea para la iluminación de acentuación

Features

- * Voltage: AC 220-240V 50/60Hz 165mA
- * 15,000hrs long life time
- * Instant start with full bright output flick free
- * Perfect replacement for 175W incandescent bulb
- * Low temperature, safety to touch
- * No UV or IR emission, mercury FREE
- * This bulb is not suitable for accent lighting



20W E27 2000 Lumen
G120



Item No.	R09212	R09213
Potencia nominal/Wattage(W)	20	
Temperatura de color/CCT(K)	3000K	4000K
Flujo luminoso/Luminous Flux(lm)	1900	2000
Tensión nominal/Voltage(V)	AC 220-240V 50/60Hz	
Regulable/Dimmable	NO	
CRI	≥80	
Casquillo/Lamp Head	E27	
Ángulo/Beam Angle(deg)	270°	
Material	Aluminio+Cristal/Aluminum+Glass	
Dimensiones/Dimensions(mm)	Ø120*157	

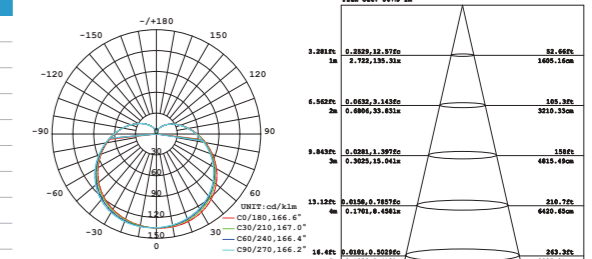

LED GX53 Bulb

Características

- * Voltaje: AC 100-250V 50/60Hz 80mA
- * 20,000 hrs. Vida útil
- * Encendido instantáneo con potencia total
- * Perfecta para reemplazar la bombilla incandescente de 80W
- * Baja temperatura al tacto
- * Libre de mercurio, libre de emisión UV & IR
- * Esta bombilla no es idónea para la iluminación de acentuación

Features

- * Voltage: AC 100-250V 50/60Hz 80mA
- * 20,000hrs long life time
- * Instant start with full bright output flick free
- * Perfect replacement for 80W incandescent bulb
- * Low temperature, safety to touch
- * No UV or IR emission, mercury FREE
- * This bulb is not suitable for accent lighting



9W GX53 730 Lumen



9W LED ↔ 80W Incandescent lamp (Lux.)

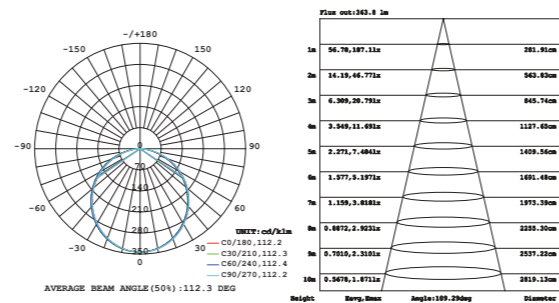
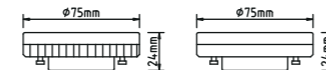

LED GX53 Bulb

Características

- * Voltaje: AC 100-250V 50/60Hz 104mA
- * 20,000 hrs. Vida útil
- * Encendido instantáneo con potencia total
- * Perfecta para reemplazar la bombilla incandescente de 100W
- * Baja temperatura al tacto
- * Libre de mercurio, libre de emisión UV & IR
- * Esta bombilla es idónea para la iluminación de acentuación

Features

- * Voltage: AC 100-250V 50/60Hz 104mA
- * 20,000hrs long life time
- * Instant start with full bright output flick free
- * Perfect replacement for 100W incandescent bulb
- * Low temperature, safety to touch
- * No UV or IR emission, mercury FREE
- * This bulb is not suitable for accent lighting



12W GX53 930 Lumen



12W LED ↔ 100W Incandescent lamp (Lux.)

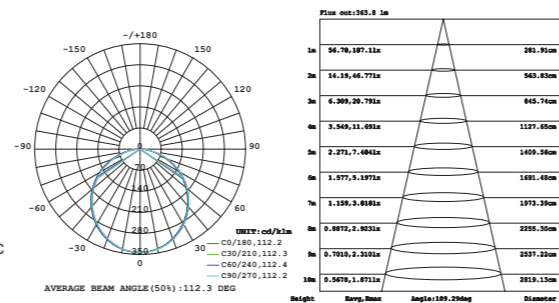
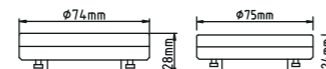

Item No.	R09248	R09249
Potencia nominal/Wattage(W)	12	
Temperatura de color/CCT(K)	3000K	4000K
Flujo luminoso/Luminous Flux(lm)	930	960
Tensión nominal/Voltage(V)	AC 100-250V 50/60Hz	
Regulable/Dimmable	NO	
CRI	≥80	
Casquillo/Lamp Head	GX53	
Ángulo/Beam Angle(deg)	120°	
Material	estampacion de aluminio & PC / Stamping aluminium & PC	
Dimensiones/Dimensions(mm)	Ø74*28	

LED G9 Bulb

Características

- * Voltaje: AC 220-240V 50/60Hz 12mA
- * 20,000 hrs. vida útil
- * Encendido instantáneo con potencia total
- * Perfecta para reemplazar la bombilla incandescente de 25W
- * Baja temperatura al tacto
- * Libre de mercurio, Libre de emisión UV & IR
- * Esta lampara no es idónea para la iluminación de acentuación

Features

- * Voltage: AC 220-240V 50/60Hz 12mA
- * 20,000hrs long life time
- * Instant start with full bright output flick free
- * Perfect replacement for 25W incandescent Bulb
- * Low temperature, safety to touch
- * No UV or IR emission, mercury FREE
- * This lamp is not suitable for accent lighting



2.5W G9 230 Lumen



2.5W LED ↔ 25W Incandescent lamp (Lux.)



Item No.	R09184	R09185
Potencia nominal/Wattage(W)	2.5	
Temperatura de color/CCT(K)	2700K	5000K
Flujo luminoso/Luminous Flux(lm)	220	230
Tensión nominal/Voltage(V)	AC 220-240V 50/60Hz	
Regulable/Dimmable	YES	
CRI	≥80	
Casquillo/Lamp Head	G9	
Ángulo/Beam Angle(deg)	360°	
Material	PC	
Dimensiones/Dimensions(mm)	Φ16*48	

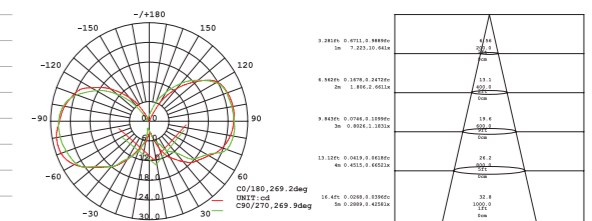

LED G9 Bulb

Características

- * Voltaje: AC 220-240V 50/60Hz 10mA
- * 20,000 hrs. vida útil
- * Encendido instantáneo con potencia total
- * Perfecta para reemplazar la bombilla incandescente de 30W
- * Baja temperatura al tacto
- * Libre de mercurio, Libre de emisión UV & IR
- * Esta lampara no es idónea para la iluminación de acentuación

Features

- * Voltage: AC 220-240V 50Hz 10mA
- * 20,000hrs long life time
- * Instant start with full bright output flick free
- * Perfect replacement for 30W incandescent Bulb
- * Low temperature, safety to touch
- * No UV or IR emission, mercury FREE
- * This lamp is not suitable for accent lighting



2.5W G9 250 Lumen



2.5W LED ↔ 30W Incandescent lamp (Lux.)

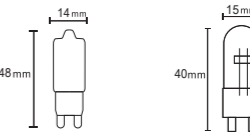

Item No.	R09226	R09227
Potencia nominal/Wattage(W)	2.5	
Temperatura de color/CCT(K)	3000K	4000K
Flujo luminoso/Luminous Flux(lm)	240	250
Tensión nominal/Voltage(V)	AC 220-240V 50/60Hz	
Regulable/Dimmable	NO	
CRI	≥80	
Casquillo/Lamp Head	G9	
Ángulo/Beam Angle(deg)	360°	
Material	Cristal / Glass	
Dimensiones/Dimensions(mm)	Φ14*48	

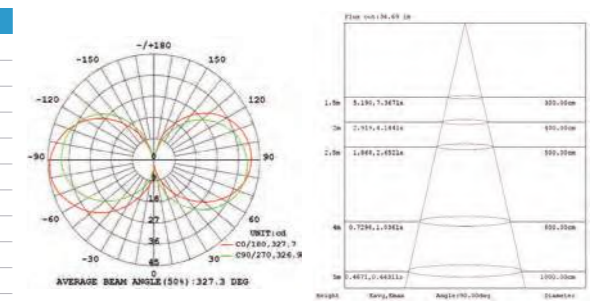

LED G9 Bulb

Características

- Voltaje: AC 220-240V 50/60Hz 30mA
- 20,000 hrs. vida útil
- Encendido instantáneo con potencia total
- Perfecta para reemplazar la bombilla incandescente de 30W
- Baja temperatura al tacto
- Libre de mercurio, Libre de emisión UV & IR
- Esta lámpara no es idónea para la iluminación de acentuación

Features

- Voltage: AC 220-240V 50/60Hz 30mA
- 20,000hrs long life time
- Instant start with full bright output flick free
- Perfect replacement for 30W incandescent Bulb
- Low temperature, safety to touch
- No UV or IR emission, mercury FREE
- This lamp is not suitable for accent lighting

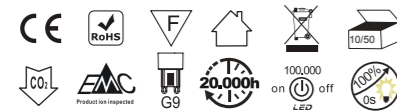

3.5W G9 375 Lumen



3.5W LED ↔ 30W Incandescent lamp (Lux.)



Item No.	R09202	R09203
Potencia nominal/Wattage(W)		3.5
Temperatura de color/CCT(K)	2700K	5000K
Flujo luminoso/Luminous Flux(lm)	360	375
Tensión nominal/Voltage(V)	AC 220-240V 50/60Hz	
Regulable/Dimmable	NO	
CRI	≥80	
Casquillo/Lamp Head	G9	
Ángulo/Beam Angle(deg)	360°	
Material	Ceramic / PCB	
Dimensiones/Dimensions(mm)	Φ16*50	

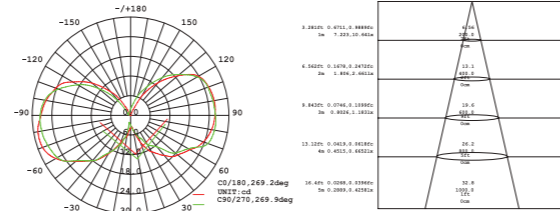

New

LED GU10 Bulb

Características

- Voltaje: AC 220-240V 50/60Hz 100mA
- 25,000 hrs. Vida útil
- Encendido instantáneo con potencia total
- Perfecta para reemplazar la bombilla incandescente de 35W
- Baja temperatura al tacto
- Libre de mercurio, Libre de emisión UV & IR
- Esta bombilla no es idónea para la iluminación de acentuación

Features

- Voltage: AC 220-240V 50/60Hz 100mA
- 25,000hrs long life time
- Instant start with full bright output flick free
- Perfect replacement for 35W incandescent bulb
- Low temperature, safety to touch
- No UV or IR emission, mercury FREE
- This bulb is not suitable for accent lighting

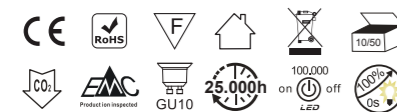

4W GU10 310 Lumen



4W LED ↔ 35W Incandescent lamp (Lux.)

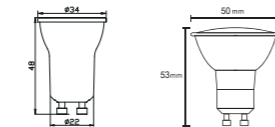

Item No.	R09280	R09281	R09282
Potencia nominal/Wattage(W)		4	
Temperatura de color/CCT(K)	2700K	3000K	4000K
Flujo luminoso/Luminous Flux(lm)	290	310	330
Tensión nominal/Voltage(V)	AC 220-240V 50/60Hz		
Regulable/Dimmable	NO		
CRI	≥80		
Casquillo/Lamp Head	GU10		
Ángulo/Beam Angle(deg)	38°		
Material	Aluminio+PC/Aluminum+PC		
Dimensiones/Dimensions(mm)	Φ34*48		

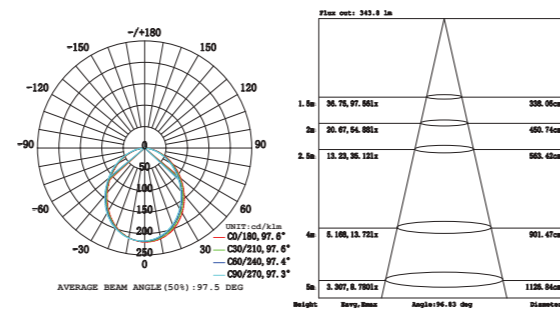

LED GU10 Bulb

Características

- Voltaje: AC 220-240V 50/60Hz
- 25,000 hrs. vida útil
- Encendido instantáneo con potencia total
- Perfecta para reemplazar la bombilla incandescente de 75W
- Baja temperatura al tacto
- Libre de mercurio, Libre de emisión UV & IR
- Esta bombilla no es idónea para la iluminación de acentuación

Features

- Voltage: AC 220-240V 50/60Hz
- 25,000hrs long life time
- Instant start with full bright output flick free
- Perfect replacement for 75W incandescent bulb
- Low temperature, safety to touch
- No UV or IR emission, mercury FREE
- This bulb is not suitable for accent lighting



Dimmable
9W GU10 820 Lumen



9W LED ↔ 75W Incandescent lamp (Lux.)

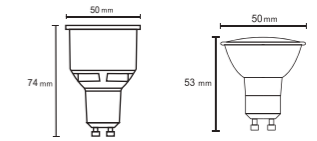

Item No.	R09218	R09219	R09220
Potencia nominal/Wattage(W)		9	
Temperatura de color/CCT(K)	3000K	3000K	4000K
Flujo luminoso/Luminous Flux(lm)	800	800	820
Tensión nominal/Voltage(V)	AC 220-240V 50/60Hz 45mA	AC 100-240V 50/60Hz 80mA	
Regulable/Dimmable	YES	NO	NO
CRI	≥80		
Casquillo/Lamp Head	GU10		
Ángulo/Beam Angle(deg)	50°		
Material	Aluminio+PC/Aluminum+PC		
Dimensiones/Dimensions(mm)	Φ50*74		

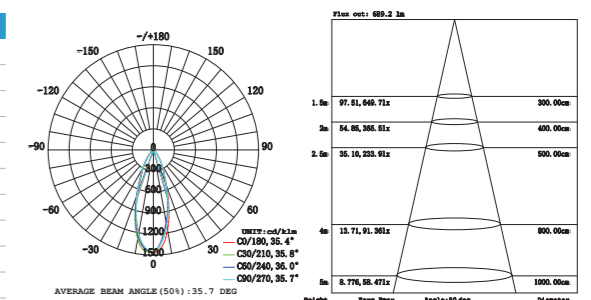

LED GU10 Bulb

Características

- Voltaje: AC 220-240V 50/60Hz 40mA
- 20,000 hrs. vida útil
- Encendido instantáneo con potencia total
- Perfecta para reemplazar la bombilla incandescente de 35W
- Baja temperatura al tacto
- Libre de mercurio, Libre de emisión UV & IR
- Esta bombilla no es idónea para la iluminación de acentuación

Features

- Voltage: AC 220-240V 50/60Hz 40mA
- 20,000hrs long life time
- Instant start with full bright output flick free
- Perfect replacement for 35W incandescent bulb
- Low temperature, safety to touch
- No UV or IR emission, mercury FREE
- This bulb is not suitable for accent lighting

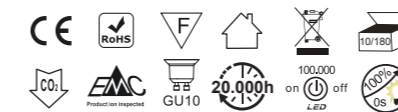

4W GU10 360 Lumen



4W LED ↔ 35W Incandescent lamp (Lux.)

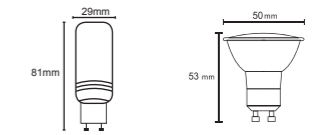

Item No.	R09207
Potencia nominal/Wattage(W)	4
Temperatura de color/CCT(K)	3000K
Flujo luminoso/Luminous Flux(lm)	360
Tensión nominal/Voltage(V)	AC 220-240V 50/60Hz
Regulable/Dimmable	NO
CRI	≥80
Casquillo/Lamp Head	GU10
Ángulo/Beam Angle(deg)	360°
Material	Aluminio+PC/Aluminum+PC
Dimensiones/Dimensions(mm)	Φ29*81

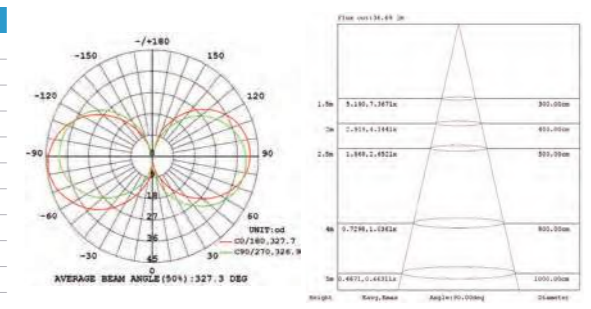

LED GU10 Bulb

Características

- Voltaje: AC 220-240V 50/60Hz 56mA
- 25,000 hrs. vida útil
- Encendido instantáneo con potencia total
- Perfecta para reemplazar la bombilla incandescente de 65W
- Baja temperatura al tacto
- Libre de mercurio, Libre de emisión UV & IR
- Esta bombilla no es idónea para la iluminación de acentuación

Features

- Voltage: AC 220-240V 50/60Hz 56mA
- 25,000hrs long life time
- Instant start with full bright output flick free
- Perfect replacement for 65W incandescent bulb
- Low temperature, safety to touch
- No UV or IR emission, mercury FREE
- This bulb is not suitable for accent lighting



8W GU10 641 Lumen

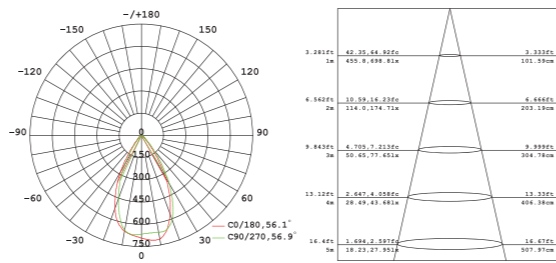

Item No.	R09156
Potencia nominal/Wattage(W)	8
Temperatura de color/CCT(K)	3000K
Flujo luminoso/Luminous Flux(lm)	641
Tensión nominal/Voltage(V)	AC 220-240V 50/60Hz
Regulable/Dimmable	NO
CRI	≥80
Casquillo/Lamp Head	GU10
Ángulo/Beam Angle(deg)	60°
Material	Aluminio&PC / Aluminum&PC
Dimensiones/Dimensions(mm)	Φ50*58

LED GU10 Bulb

Características

- Voltaje: AC 220-240V 50/60Hz 34mA
- 15,000 hrs. vida útil
- Encendido instantáneo con potencia total
- Perfecta para reemplazar la bombilla incandescente de 60W
- Baja temperatura al tacto
- Libre de mercurio, Libre de emisión UV & IR
- Esta bombilla no es idónea para la iluminación de acentuación

Features

- Voltage: AC 220-240V 50/60Hz 34mA
- 15,000hrs long life time
- Instant start with full bright output flick free
- Perfect replacement for 60W incandescent bulb
- Low temperature, safety to touch
- No UV or IR emission, mercury FREE
- This bulb is not suitable for accent lighting



7W GU10 570 Lumen

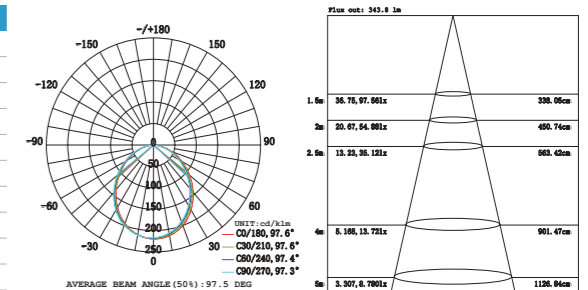
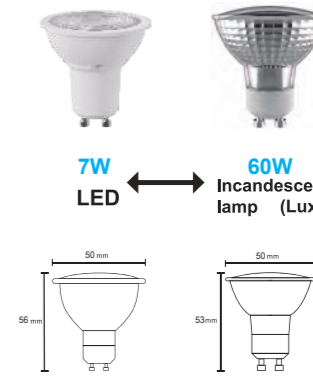

Item No.	R09254	R09255	R09256
Potencia nominal/Wattage(W)		7	
Temperatura de color/CCT(K)	2700K	3000K	4000K
Flujo luminoso/Luminous Flux(lm)	510	540	570
Tensión nominal/Voltage(V)	AC 220-240V 50/60Hz		
Regulable/Dimmable	NO		
CRI	≥80		
Casquillo/Lamp Head	GU10		
Ángulo/Beam Angle(deg)	50°		
Material	Aluminio+PC/Aluminum+PC		
Dimensiones/Dimensions(mm)	Φ50*56		

LED GU10 Bulb

Características

- Voltaje: AC 220-240V 50/60Hz 55mA
- 15,000 hrs. vida útil
- Encendido instantáneo con potencia total
- Perfecta para reemplazar la bombilla incandescente de 60W
- Baja temperatura al tacto
- Libre de mercurio, Libre de emisión UV & IR
- Esta bombilla no es idónea para la iluminación de acentuación

Features

- Voltage: AC 220-240V 50/60Hz 55mA
- 15,000hrs long life time
- Instant start with full bright output flick free
- Perfect replacement for 60W incandescent bulb
- Low temperature, safety to touch
- No UV or IR emission, mercury FREE
- This bulb is not suitable for accent lighting



6W GU10 540 Lumen

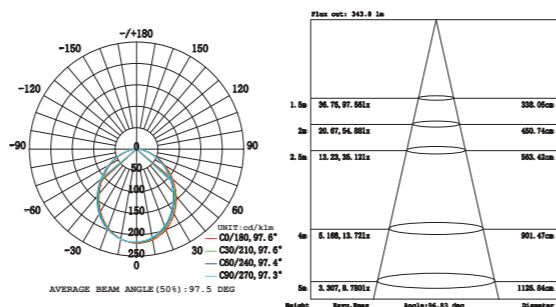

Item No.	R09196	R09214	R09197
Potencia nominal/Wattage(W)	6		
Temperatura de color/CCT(K)	3000K	4000K	5000K
Flujo luminoso/Luminous Flux(lm)	520	540	540
Tensión nominal/Voltage(V)	AC 220-240V 50/60Hz		
Regulable/Dimmable	NO		
CRI	≥80		
Casquillo/Lamp Head	GU10		
Ángulo/Beam Angle(deg)	110°		
Material	Aluminio+PC/Aluminum+PC		
Dimensiones/Dimensions(mm)	Φ50*56		

LED GU10 Bulb

Características

- Voltaje: AC 220-240V 50/60Hz 30mA
- 15,000 hrs. vida útil
- Encendido instantáneo con potencia total
- Perfecta para reemplazar la bombilla incandescente de 60W
- Baja temperatura al tacto
- Libre de mercurio, Libre de emisión UV & IR
- Esta bombilla no es idónea para la iluminación de acentuación

Features

- Voltage: AC 220-240V 50/60Hz 30mA
- 15,000hrs long life time
- Instant start with full bright output flick free
- Perfect replacement for 60W incandescent bulb
- Low temperature, safety to touch
- No UV or IR emission, mercury FREE
- This bulb is not suitable for accent lighting



7W GU10 570 Lumen DIMMABLE

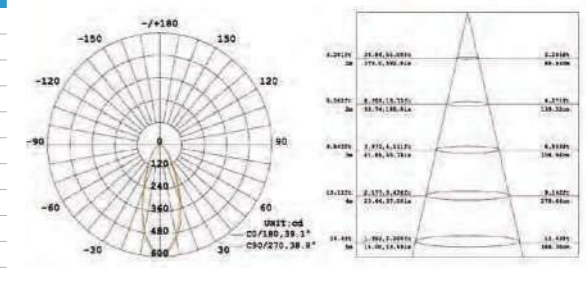
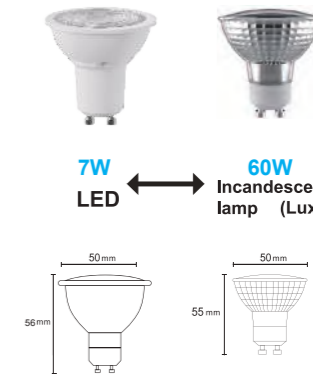

Item No.	R09257	R09258	R09259
Potencia nominal/Wattage(W)		7	
Temperatura de color/CCT(K)	2700K	3000K	4000K
Flujo luminoso/Luminous Flux(lm)	510	540	570
Tensión nominal/Voltage(V)	AC 220-240V 50/60Hz		
Regulable/Dimmable	YES		
CRI	≥80		
Casquillo/Lamp Head	GU10		
Ángulo/Beam Angle(deg)	50°		
Material	Aluminio+PC/Aluminum+Glass		
Dimensiones/Dimensions(mm)	Φ50*56		

New

LED GU10 Bulb

Características

- * Voltaje: AC 220-240V 50/60Hz 27mA
- * 50,000 hrs. vida útil
- * Encendido instantáneo con potencia total
- * Perfecta para reemplazar la bombilla incandescente de 50W
- * Baja temperatura al tacto
- * Libre de mercurio, Libre de emisión UV & IR
- * Esta bombilla no es idónea para la iluminación de acentuación

Features

- * Voltage: AC 220-240V 50/60Hz 27mA
- * 50,000hrs long life time
- * Instant start with full bright output flick free
- * Perfect replacement for 50W incandescent bulb
- * Low temperature, safety to touch
- * No UV or IR emission, mercury FREE
- * This bulb is not suitable for accent lighting



2.4W LED ↔ 50W Incandescent lamp (Lux.)

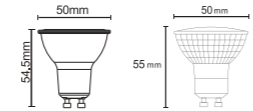

2.4W GU10 390 Lumen



Item No.	R09283	R09284	R09285
Potencia nominal/Wattage(W)		2.4	
Temperatura de color/CCT(K)	2700K	3000K	4000K
Flujo luminoso/Luminous Flux(lm)	380	390	400
Tensión nominal/Voltage(V)	AC 220-240V 50/60Hz		
Regulable/Dimmable	YES		
CRI	≥80		
Casquillo/Lamp Head	GU10		
Ángulo/Beam Angle(deg)	38°		
Material	Aluminio+ Cristal/Aluminum+Glass		
Dimensiones/Dimensions(mm)	Φ50*54.5		

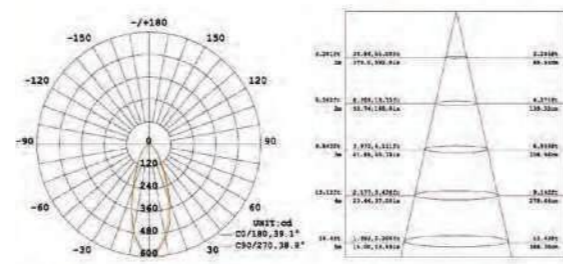

LED G4 Bulb

Características

- * Voltaje: AC/DC 12V 140mA
- * 20,000 hrs. Vida útil
- * Encendido instantáneo con potencia total
- * Perfecta para reemplazar la bombilla incandescente de 20W
- * Baja temperatura al tacto
- * Libre de mercurio, libre de emisión UV & IR
- * Esta bombilla no es idónea para la iluminación de acentuación

Features

- * Voltage: AC/DC 12V 140mA
- * 20,000hrs long life time
- * Instant start with full bright output flick free
- * Perfect replacement for 20W incandescent bulb
- * Low temperature, safety to touch
- * No UV or IR emission, mercury FREE
- * This bulb is not suitable for accent lighting



2W LED ↔ 20W Incandescent lamp (Lux.)

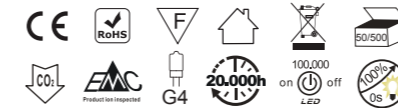
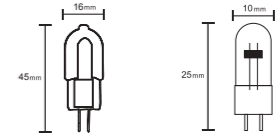

2W G4 190 Lumen



Item No.	R09209	R09210
Potencia nominal/Wattage(W)		2
Temperatura de color/CCT(K)	3000K	5000K
Flujo luminoso/Luminous Flux(lm)		190
Tensión nominal/Voltage(V)	AC/DC 12V	
Regulable/Dimmable	NO	
CRI	≥80	
Casquillo/Lamp Head	G4	
Ángulo/Beam Angle(deg)	240°	
Material	PC	
Dimensiones/Dimensions(mm)	L16*W12*H45	

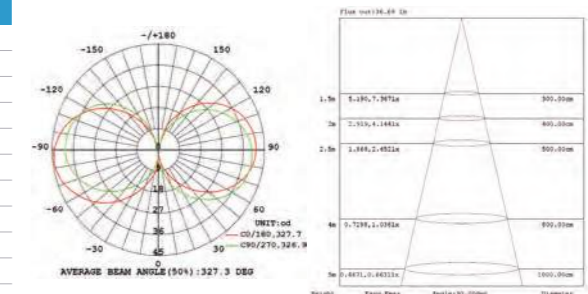

LED G4 Bulb

Características

- * Voltaje: AC/DC 12V 345mA
- * 20,000 hrs. Vida útil
- * Encendido instantáneo con potencia total
- * Perfecta para reemplazar la bombilla incandescente de 35W
- * Baja temperatura al tacto
- * Libre de mercurio, libre de emisión UV & IR
- * Esta bombilla no es idónea para la iluminación de acentuación

Features

- * Voltage: AC/DC 12V 345mA
- * 20,000hrs long life time
- * Instant start with full bright output flick free
- * Perfect replacement for 35W incandescent bulb
- * Low temperature, safety to touch
- * No UV or IR emission, mercury FREE
- * This bulb is not suitable for accent lighting



5W LED ↔ 35W Incandescent lamp (Lux.)

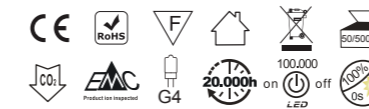
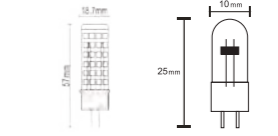

5W G4 500 Lumen



Item No.	R09243	R09247
Potencia nominal/Wattage(W)		5
Temperatura de color/CCT(K)	3000K	4000K
Flujo luminoso/Luminous Flux(lm)		500
Tensión nominal/Voltage (V)	AC/DC 12V	
Regulable/Dimmable	NO	
CRI	≥80	
Casquillo/Lamp Head	G4	
Ángulo/Beam Angle(deg)	360°	
Material	PCB&Ceramic	
Dimensiones/Dimensions(mm)	Ø19*57	

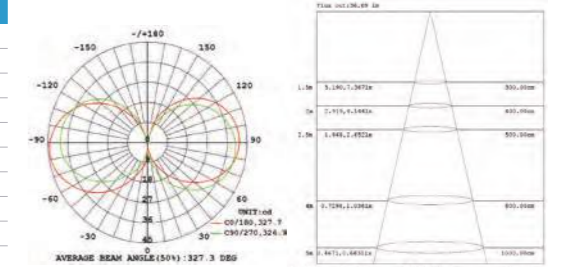

1326	FLAME	452	6093	CAICOS	74	6495	MERIBEL	364	6562	MURAL	165	6761	MORNE	48	6858	GUINCHO	304	7061	CHAMONIX	422	7202	FIJI	240	7361	TIRAS LED	318	7401	TIRAS LED	323
1388	AVORIAZ	478	6211	KINKÉ	435	6508	TEJA	368	6563	MURAL	175	6762	MORNE	48	6859	GUINCHO	304	7062	CHAMONIX	404	7203	FIJI	240	7362	TIRAS LED	318	7402	TIRAS LED	323
1391	AVORIAZ	478	6212	KINKÉ	434	6510	KANDAN-CHU	376	6620	SAONA SUP	98	6763	MORNE	48	6860	GUINCHO	304	7063	CHAMONIX	404	7204	FIJI	240	7363	TIRAS LED	320	7403	TIRAS LED	321
1394	AVORIAZ	478	6213	KINKÉ	436	6511	KANDAN-CHU	376	6621	SAONA SUP	98	6768	IGUAZU	374	6861	GUINCHO	304	7065	VERBIER	420	7205	FIJI	240	7364	TIRAS LED	320	7404	TIRAS LED	321
1397	AVORIAZ	440	6214	KINKÉ	436	6512	KANDAN-CHU	377	6622	SAONA SUP	98	6769	IGUAZU	374	6862	GUINCHO	304	7066	VERBIER	420	7206	FIJI	240	7365	TIRAS LED	320	7405	TIRAS LED	321
1398	AVORIAZ	440	6215	KINKÉ	436	6513	KANDAN-CHU	377	6623	SAONA SUP	98	6770	RUKA	362	6865	FUERTE-VENTURA	54	7070	SOLDEN	397	7207	FIJI	240	7366	TIRAS LED	318	7406	TIRAS LED	321
1399	AVORIAZ	440	6218	KINKÉ	436	6514	KANDAN-CHU	376	6624	SAONA SUP	98	6771	RUKA	464	7011	BAKER	486	7071	SOLDEN	397	7208	FIJI	242	7367	TIRAS LED	318	7407	TIRAS LED	328
1400	FLAME	480	6220	ASIMETRIC	50	6515	KANDAN-CHU	376	6625	SAONA SUP	98	6772	RUKA	464	7012	BAKER	486	7072	SOLDEN	396	7209	FIJI	242	7368	TIRAS LED	318	7408	TIRAS LED	328
5410	ZERO E27	96	6221	ASIMETRIC	50	6516	KANDAN-CHU	377	6626	SAONA SUP	98	6773	RUKA	464	7013	BAKER	490	7073	SOLDEN	396	7210	FIJI	242	7369	TIRAS LED	321	7409	TIRAS LED	328
5411	ZERO E27	96	6222	ASIMETRIC	50	6517	KANDAN-CHU	377	6627	SAONA SUP	98	6774	RUKA	464	7014	BAKER	490	7080	GUINCHO	304	7211	FIJI	242	7370	TIRAS LED	321	7410	TIRAS LED	328
5622	ARUBA	150	6230	MURAL	82	6520	DAVOS	382	6628	SAONA SUP	99	6810	COMFORT IP	315	7015	BAKER	486	7081	GUINCHO	304	7212	FIJI	242	7371	TIRAS LED	330	7411	TIRAS LED	328
5623	ARUBA	150	6280	SAL BLANCO	180	6521	DAVOS	382	6629	SAONA SUP	99	6811	COMFORT IP	315	7016	BAKER	486	7082	GUINCHO	304	7213	FIJI	242	7374	TIRAS LED	330	7412	TIRAS LED	328
5624	ARUBA	150	6281	SAL BLANCO	180	6522	DAVOS	382	6630	SAONA SUP	99	6812	COMFORT IP	315	7017	BAKER	490	7083	GUINCHO	304	7214	FIJI	242	7375	TIRAS LED	330	7413	TIRAS LED	328
5625	ARUBA	150	6282	SAL BLANCO	180	6523	DAVOS	382	6631	SAONA SUP	99	6813	COMFORT IP	315	7018	BAKER	490	7085	MERIBEL	456	7215	FIJI	242	7376	TIRAS LED	331	7414	TIRAS LED	328
5626	ARUBA	190	6283	SAL BLANCO	59	6524	DAVOS	382	6632	SAONA SUP	99	6820	GOKOVA	66	7021	ASPEN	492	7086	MERIBEL	394	7216	FIJI	242	7377	TIRAS LED	331	7415	TIRAS LED	328
5627	ARUBA	190	6284	SAL BLANCO	60	6525	TRIAx	386	6633	SAONA SUP	99	6821	GOKOVA	66	7022	ASPEN	492	7088	CHEVALIER	466	7217	FIJI	242	7378	TIRAS LED	329	7416	TIRAS LED	328
5628	ARUBA	190	6380	PARACURU	84	6526	TRIAx	386	6634	SAONA SUP	99	6825	TORCH	148	7023	ASPEN	492	7107	TAOS	482	7218	FIJI	242	7379	TIRAS LED	329	7417	TIRAS LED	325
5629	ARUBA	190	6381	PARACURU	84	6527	DAVOS	382	6635	SAONA SUP	99	6826	TORCH	148	7024	ASPEN	492	7108	TAOS	406	7219	FIJI	242	7380	TIRAS LED	329	7418	TIRAS LED	325
6015	ARUBA	188	6382	PARACURU	84	6530	SOCHI	388	6700	TORCH	56	6827	TORCH	92	7025	ASPEN	492	7109	TAOS	406	7220	FIJI	242	7381	TIRAS LED	322	7419	TIRAS LED	325
6016	ARUBA	188	6383	PARACURU	84	6531	SOCHI	388	6701	TORCH	56	6828	TORCH	92	7026	ASPEN	492	7130	POLINESIA	432	7221	FIJI	242	7382	TIRAS LED	322	7420	URANO	341
6044	ARUBA	236	6384	PARACURU	84	6534	BORA	390	6702	TORCH	56	6830	GOWER	186	7027	ASPEN	494	7131	POLINESIA	430	7222	FIJI	242	7383	TIRAS LED	322	7421	URANO	341
6045	ARUBA	236	6385	PARACURU	84	6535	BORA	390	6703	TORCH	56	6831	GOWER	186	7028	ASPEN	494	7133	POLINESIA	358	7223	FIJI	242	7384	TIRAS LED	322	7422	URANO	341
6046	BOAVISTA	64	6390	GRACIOSA	265	6536	BORA	390	6710	SAL NEGRO	180	6832	GOWER	186	7029	ASPEN	494	7175	DURBAN	46	7224	FIJI	222	7385	TIRAS LED	322	7423	URANO	343
6047	BOAVISTA	64	6395	MEDANO	264	6537	BORA	390	6711	SAL NEGRO	180	6833	GOWER	186	7030	ASPEN	494	7176	DURBAN	46	7294	IOS	184	7386	TIRAS LED	322	7424	URANO	343
6050	BOAVISTA	65	6398	MEDANO	264	6538	BORA	390	6712	SAL NEGRO	180	6835	LAMBORJINI	299	7031	ASPEN	494	7177	DURBAN	46	7295	IOS	184	7387	TIRAS LED	322	7425	URANO	343
6051	BOAVISTA	65	6399	MEDANO	264	6539	BORA	390	6713	SAL NEGRO	60	6837	LAMBORJINI	299	7032	ASPEN	494	7180	LEVI	409	7305	ORION	144	7388	TIRAS LED	322	7426	URANO	345
6070	TARIFA	70	6400	GARDA	280	6540	ARCS	356	6714	SAL NEGRO	60	6838	LAMBORJINI	299	7037	KANDAN-CHU	376	7181	LEVI	409	7306	ORION	146	7389	TIRAS LED	322	7427	URANO	345
6071	TARIFA	70	6401	GARDA	280	6541	ARCS	356	6717	SAL BLANCO	238	6839	LAMBORJINI	298	7038	KANDAN-CHU	376	7182	LEVI	408	7307	ORION	142	7390	TIRAS LED	322	7428	URANO	345
6072	TARIFA	70	6402	GARDA	280	6550	MAYA	460	6718	SAL NEGRO	238	6840	LAMBORJINI	298	7039	KANDAN-CHU	377	7183	LEVI	408	7308	ORION	142	7391	TIRAS LED	322	7429	URANO	347
6075	P R E A	72	6403	GARDA	280	6551	MAYA	460	6735	TORCH	172	6841	LAMBORJINI	298	7040	KANDAN-CHU	377	7184	LEVI	426	7315	IPSILON	230	7392	TIRAS LED	323	7430	URANO	347
6076	P R E A	72	6405	ATLANTIS	314	6552	MAYA	460	6736	TORCH	172	6842	LAMBORJINI	298	7045	ALPINE	402	7185	LEVI	426	7316	IPSILON	230	7393	TIRAS LED	323	7431	URANO	347
6077	P R E A	72	6406	ATLANTIS	314	6553	MAYA	416	6737	TORCH	162	6843	LAMBORJINI	298	7046	ALPINE	402	7186	LEVI	427	7317	IPSILON	230	7394	TIRAS LED	323	7435	DAVOS XL	382
6080	CAYMAN	62	6482	VOLCANO	370	6554	MAYA	416	6738	TORCH	162	6844	LAMBORJINI	298	7050	UTAH	392	7187	LEVI	427	7318	IPSILON	230	7395	TIRAS LED	323	7436	DAVOS XL	382
6081	CAYMAN	62	6483	VOLCANO	366	6555	MAYA	438	6750	ZANZIBAR	52	6845	LAMBORJINI	298	7051	UTAH	392	7197	DURBAN	46	7319	IPSILON	230	7396	TIRAS LED	323	7437	DAVOS XL	382
6082	CAYMAN	62	6490	MERIBEL	458	6558	IGUAZU	372	6752	ZANZIBAR	52	6846	LAMBORJINI	298	7052	UTAH	392	7198	DURBAN	46	7320	IPSILON	230	7397	TIRAS LED	323	7438	DAVOS XL	382
6083	CAYMAN	62	6492	MERIBEL	364	6559	IGUAZU	372	6754	ZANZIBAR	52	6855	GUINCHO	304	7055	BACHELOR	424	7199	DURBAN	46	7321	IPSILON	230	7398	TIRAS LED	323	7451	NEPTUNO	282
6091	CAICOS	74	6493	MERIBEL	364	6560	MURAL	94	6755	ZANZIBAR	52	6856	GUINCHO	304	7056	BACHELOR	424	7200	FIJI	240	7322	IPSILON	230	7399	TIRAS LED	323	7452	NEPTUNO	282
6092	CAICOS	74	6494	MERIBEL	364	6561	MURAL	94	6760	MORNE	48	6857	GUINCHO	304	7060	CHAMONIX	422	7201	FIJI	240	7360	TIRAS LED	318	7400	TIRAS LED	323	7453	NEPTUNO	282

7454	NEPTUNO	282	7544	HANOK	128	7694	LUPPI	34	7791	PAGODA	136	7903	KANDAN-CHU	412	7990	LOTUS	352	8098	ALTEA	26	8311	MAGNETO	216	8349	MAGNETO	218	8387	MAGNETO	206
7460	MURAL	82	7545	HANOK	128	7695	LUPPI	34	7813	ARCS	356	7904	KANDAN-CHU	413	7991	LOTUS	352	8108	CHICAGO	470	8312	MAGNETO	216	8350	MAGNETO	218	8388	MAGNETO	200
7462	MURAL	94	7546	HANOK	126	7720	GOA	40	7814	ARCS	356	7905	KANDAN-CHU	413	7992	LOTUS	352	8109	CHICAGO	470	8313	MAGNETO	212	8351	MAGNETO	218	8389	MAGNETO	208
7463	MURAL	94	7547	HANOK	126	7721	GOA	40	7815	DAVOS DOUBLE	384	7906	KANDAN-CHU	413	7993	LOTUS	352	8122	ORION	22	8314	MAGNETO	212	8352	UTAH	392	8390	MAGNETO	208
7464	MURAL	164	7548	HANOK	130	7730	GLACIAR	182	7816	DAVOS DOUBLE	384	7907	KANDAN-CHU	413	7994	LOTUS	352	8123	ORION	22	8315	MAGNETO	201	8353	UTAH	392	8391	MAGNETO	208
7465	MURAL	174	7549	HANOK	130	7731	GLACIAR	182	7817	DAVOS DOUBLE	384	7908	VOLCANO	414	7995	LOTUS	352	8124	ORION	22	8316	MAGNETO	201	8354	UTAH	392	8392	MAGNETO	208
7470	KANDAN-CHU	376	7550	HANOK	130	7732	GLACIAR	182	7818	DAVOS DOUBLE	384	7910	TOBAGO	28	7996	LOTUS	352	8125	ORION	22	8317	MAGNETO	201	8355	BOLONIA	106	8435	KILDA	114
7471	KANDAN-CHU	376	7551	HANOK	130	7733	GLACIAR	182	7819	DAVOS DOUBLE	384	7911	TOBAGO	28	7997	LOTUS	352	8126	ORION	22	8318	MAGNETO	205	8356	BOLONIA	106	8436	KILDA	114
7472	KANDAN-CHU	377	7552	HANOK	130	7734	GLACIAR	182	7820	DAVOS DOUBLE	384	7912	TOBAGO	28	8010	VENUS	44	8127	ORION	22	8319	MAGNETO	205	8357	BOLONIA	106	8437	KILDA	114
7473	KANDAN-CHU	377	7553	HANOK	130	7735	GLACIAR	182	7821	DAVOS DOUBLE	384	7913	TOBAGO	28	8011	VENUS	44	8128	ORION	22	8320	MAGNETO	204	8358	BOLONIA	106	8438	KILDA	116
7475	ORION	138	7554	HANOK	132	7740	BASICO GU10	292	7822	DAVOS DOUBLE	384	7914	TOBAGO	28	8012	VENUS	44	8129	ORION	22	8321	MAGNETO	204	8359	CRETA	224	8439	KILDA	116
7476	ORION	140	7555	HANOK	132	7741	BASICO GU10	292	7823	CAYMAN	62	7915	TOBAGO	28	8013	VENUS	44	8130	ORION	22	8322	MAGNETO	205	8360	CRETA	224	8440	KILDA	116
7480	MORNE	48	7556	HANOK	132	7742	BASICO GU10	292	7824	CAYMAN	62	7928	BERET	355	8034	VENUS	44	8151	ALPINE	468	8323	MAGNETO	203	8361	CRETA	224	8441	MAGNETO	207
7481	MORNE	48	7557	HANOK	132	7743	BASICO GU10	292	7825	CAYMAN	62	7929	BERET	354	8035	VENUS	44	8152	ANDES	350	8324	MAGNETO	203	8362	CRETA	224	8442	MAGNETO	207
7482	MORNE	48	7558	HANOK	132	7760	KUBICK	36	7826	CAYMAN	62	7930	RELAX	444	8060	TIRAS LED	325	8153	ANDES	350	8325	MAGNETO	202	8363	ITACA	228	8443	MAGNETO	207
7483	MORNE	48	7559	HANOK	132	7761	KUBICK	36	7827	NEPTUNO	282	7931	RELAX	444	8061	TIRAS LED	325	8154	ANDES	350	8326	MAGNETO	202	8364	ITACA	228	8444	MAGNETO	207
7484	MORNE	48	7569	HANOK	126	7762	KUBICK	36	7828	NEPTUNO	282	7932	RELAX	444	8062	TIRAS LED	325	8155	QUEBEC	476	8327	MAGNETO	206	8365	ITACA	228	8445	MAGNETO	209
7510	EYES	160	7592	KUBICK	36	7763	KUBICK	36	7829	GARDA	280	7933	RELAX	446	8063	TIRAS LED	325	8156	FUJI	20	8328	MAGNETO	200	8366	ITACA	228	8446	MAGNETO	209
7511	EYES	160	7593	KUBICK	36	7770	HANOK	32	7830	GARDA	280	7934	RELAX	446	8064	TIRAS LED	324	8157	FUJI	20	8329	MAGNETO	209	8367	ALTEA	26	8447	TRIMASI	266
7512	EYES	170	7594	KUBICK	36	7771	HANOK	32	7831	GARDA	280	7935	RELAX	446	8065	TIRAS LED	324	8158	FUJI	20	8330	MAGNETO	219	8368	ALTEA	26	8448	TRIMASI	266
7513	EYES	42	7595	KUBICK	36	7772	HANOK	32	7832	GARDA	280	7936	IOS	124	8066	TIRAS LED	324	8159	FUJI	20	8331	MAGNETO	219	8369	ALTEA	26	8449	TRIMASI	267
7514	EYES	42	7596	KUBICK	36	7773	HANOK	32	7833	GARDA	280	7937	IOS	124	8067	TIRAS LED	326	8293	TIRAS LED	330	8332	MAGNETO	201	8370	ALTEA	26	8450	TRIMASI	267
7515	SAL NEGRO	158	7597	KUBICK	36	7774	HANOK	30	7834	GARDA	280	7945	HANOK	88	8068	TIRAS LED	326	8294	TIRAS LED	330	8333	MAGNETO	201	8371	MAGNETO	214	8451	TRIMASI	267
7516	SAL NEGRO	158	7640	BAKER	486	7775	HANOK	30	7840	MURAL	82	7946	HANOK	88	8069	TIRAS LED	326	8295	SAL BLANCO	284	8334	MAGNETO	201	8372	MAGNETO	214	8452	TRIMASI	268
7517	SAL NEGRO	168	7641	BAKER	490	7776	HANOK	30	7841	MURAL	82	7947	HANOK	88	8070	TIRAS LED	327	8296	SAL NEGRO	284	8335	MAGNETO	205	8373	MAGNETO	214	8453	TRIMASI	268
7518	SAL NEGRO	58	7642	BAKER	486	7777	HANOK	30	7853	CAYMAN	62	7948	HANOK	88	8071	TIRAS LED	327	8297	SAL BLANCO	120	8336	MAGNETO	205	8374	MAGNETO	214	8454	TRIMASI	269
7519	SAL NEGRO	58	7643	BAKER	490	7778	HANOK	30	7854	CAYMAN	62	7949	HANOK	88	8072	TIRAS LED	327	8298	SAL NEGRO	120	8337	MAGNETO	204	8375	MAGNETO	214	8455	TRIMASI	269
7520	SAL BLANCO	158	7645	DAVOS	384	7780	PAGODA	234	7855	BASES EM-POTRAR	152	7950	HANOK	88	8087	TAHITI XL	24	8300	MAGNETO	212	8338	MAGNETO	204	8376	MAGNETO	214	8456	TRIMASI	269
7521	SAL BLANCO	158	7646	DAVOS	384	7781	PAGODA	234	7856	BASES EM-POTRAR	152	7951	HANOK	88	8088	TAHITI XL	24	8301	MAGNETO	212	8339	MAGNETO	205	8377	MAGNETO	212	8457	TRIMASI	269
7522	SAL BLANCO	168	7647	DAVOS	384	7782	PAGODA	234	7857	BASES EM-POTRAR	152	7952	HANOK	88	8089	TAHITI XL	24	8302	MAGNETO	212	8340	MAGNETO	203	8378	UTAH	418	8458	TRIMASI	269
7523	SAL BLANCO	58	7648	DAVOS	384	7783	PAGODA	234	7858	BASES EM-POTRAR	152	7953	HANOK	88	8090	TAHITI XL	24	8303	MAGNETO	212	8341	MAGNETO	203	8379	UTAH	418	8459	TRIMASI	269
7524	SAL BLANCO	58	7649	DAVOS	384	7784	PAGODA	134	7859	BASES EM-POTRAR	152	7961	SAL BLANCO	90	8091	ALTEA	26	8304	MAGNETO	212	8342	MAGNETO	202	8380	UTAH	418	8460	SKYLINE	338
7535	GUINCHO GU10	290	7650	DAVOS	384	7785	PAGODA	134	7865	TOBAGO	28	7962	SAL NEGRO	90	8092	ALTEA	26	8305	MAGNETO	212	8343	MAGNETO	202	8381	MAGNETO	201	8461	TORONTO	16
7536	GUINCHO GU10	290	7651	DAVOS XL	384	7786	PAGODA	134	7866	TOBAGO	28	7985	K4	450	8093	ALTEA	26	8306	MAGNETO	212	8344	MAGNETO	206	8382	MAGNETO	201	8462	TORONTO	16
7540	HANOK	128	7652	DAVOS XL	384	7787	PAGODA	134	7867	TOBAGO	28	7986	K4	450	8094	ALTEA	26	8307	MAGNETO	216	8345	MAGNETO	200	8383	MAGNETO	206	8463	TORONTO	16
7541	HANOK	128	7653	DAVOS XL	384	7788	PAGODA	232	7900	KANDAN-CHU	412	7987	K4	450	8095	ALTEA	26	8308	MAGNETO	216	8346	MAGNETO	209	8384	MAGNETO	200	8464	TORONTO	16
7542	HANOK	126	7654	DAVOS XL	384	7789	PAGODA	232	7901	KANDAN-CHU	412	7988	K5	448	8096	ALTEA	26	8309	MAGNETO	216	8347	MAGNETO	218	8385	MAGNETO	201	8465	GRUISSAN	108
7543	HANOK	126	7693	LUPPI	34	7790	PAGODA	136	7902	KANDAN-CHU	412	7989	K5	448	8097	ALTEA	26	8310	MAGNETO	216	8348	MAGNETO	218	8386	MAGNETO	201	8466	GRUISSAN	108

8467	GRUISSAN	112	8551	CARRILES T	250	8661	KIEL	308	8742	CARRILES T	253	8797	SUNSET	272	C0002	BASICO GU10	294	C0129	BORA BORA	78		SKB123	CARRILES TR	247			
8468	GRUISSAN	110	8552	CARRILES T	251	8664	LANCES	286	8743	CARRILES T	253	8798	SUNSET	272	C0003	BASICO GU10	294	C0130	BORA BORA	78	TU0492	PIQUETA / SPIKE	495	XTS41003	CARRILES TR	246	
8469	GRUISSAN	110	8553	CARRILES T	251	8665	LANCES	286	8744	CARRILES T	253	8799	SUNSET	272	C0004	BASICO GU10	294	C0131	BORA BORA	76	TU0494	BASE SUJECCION	494	XTS42003	CARRILES TR	246	
8470	COOPER	398	8554	CARRILES T	251	8666	HURGADA	302	8762	PANAMA	274	8800	SUNSET	272	C0005	BASICO GU10	294	C0132	BORA BORA	76	TU0652	PIQUETA / SPIKE	495	SPW11SK15	CARRILES TR	247	
8471	COOPER	398	8555	CARRILES T	251	8667	HURGADA	302	8763	PANAMA	274	8801	SUNSET	272	C0006	BASICO GU10	294	C0133	BORA BORA	78	TU0653	PIQUETA / SPIKE	495	XTS363	CARRILES TR	249	
8472	COOPER	398	8556	CARRILES T	252	8668	HURGADA	302	8764	ROMBOK	300	8802	SUNSET	272	C0007	BASICO GU10	294	C0134	BORA BORA	78	TU0662	CONEXIÓN IP68	494	XTS373	CARRILES TR	249	
8473	COOPER	398	8557	CARRILES T	252	8669	HURGADA	302	8765	ROMBOK	300	8803	SUNSET	272	C0008	BASICO GU10	294	C0160	COMFORT GU10	296	TU0663	CONEXIÓN IP68	494	XTS393	CARRILES TR	249	
8474	COOPER	400	8558	CARRILES T	252	8670	HURGADA	302	8766	ROMBOK	300	8804	SUNSET	272	C0041	CABRERA	258	C0161	COMFORT GU10	296				XTS403	CARRILES TR	249	
8475	COOPER	400	8559	CARRILES T	252	8671	HURGADA	302	8767	ROMBOK	300	8805	SUNSET	272	C0042	CABRERA	258	C0162	COMFORT GU10	296				XTS412	CARRILES TR	247	
8476	COOPER	400	8560	CARRILES T	251	8672	RIUMAR	102	8768	SUNSET	272	8806	SUNSET	272	C0043	CABRERA	258	C0163	COMFORT GU10	296	XTS353	CARRILES TR	248	XTS383	CARRILES TR	248	
8477	COOPER	400	8561	CARRILES T	251	8673	RIUMAR	102	8769	SUNSET	272	8807	SUNSET	272	C0044	CABRERA	258	C0164	COMFORT GU10	296	XTS343	CARRILES TR	248	XTS42002	CARRILES TR	246	
8478	NAGANO	472	8562	CARRILES T	251	8674	RIUMAR	102	8770	SUNSET	272	8808	SUNSET	272	C0047	CABRERA	258	C0165	COMFORT GU10	296	XTS243	CARRILES TR	248	XTSF41002	CARRILES TR	246	
8479	NAGANO	472	8563	CARRILES T	251	8675	RIUMAR	104	8771	SUNSET	272	8809	SUNSET	272	C0048	CABRERA	258	C0180	SAONA	260	XTS142	CARRILES TR	248	XTSF42002	CARRILES TR	246	
8480	AKITA	474	8564	CLIFTON	122	8676	RIUMAR	104	8772	SUNSET	272	8810	SUNSET	272	C0049	CABRERA	258	C0181	SAONA	260	XTS41002	CARRILES TR	246				
8481	AKITA	474	8565	CLIFTON	122	8677	RIUMAR	104	8773	SUNSET	272	8811	SUNSET	272	C0050	CABRERA	258	C0182	SAONA	261	XTS242	CARRILES TR	248				
8482	TORCH	118	8589	DAVOS	382	8678	ALGARVE	256	8774	SUNSET	272	8812	SUNSET	272	C0071	FORMENTERA	276	C0183	SAONA	261	XTS212	CARRILES TR	248				
8483	TORCH	118	8600	DAVOS	382	8679	ALGARVE	256	8775	SUNSET	272	8813	SUNSET	272	C0072	FORMENTERA	276	C0184	SAONA	260	XTS352	CARRILES TR	248				
8486	SAL ORO	120	8601	DAVOS	382	8680	ALGARVE	256	8776	SUNSET	272	8814	SUNSET	272	C0073	FORMENTERA	276	C0185	SAONA	260	XTS342	CARRILES TR	248				
8487	SAL ORO	180	8602	DAVOS	382	8681	ALGARVE	256	8777	SUNSET	272	8815	SUNSET	272	C0074	FORMENTERA	276	C0186	SAONA	261	XTS362	CARRILES TR	249				
8488	SAL ORO	180	8603	DAVOS	382	8682	ALGARVE	256	8778	SUNSET	272	8816	MAGNETO	201	C0075	FORMENTERA	277	C0187	SAONA	261	XTS372	CARRILES TR	249				
8489	SAL ORO	180	8604	DAVOS	382	8683	ALGARVE	256	8779	SUNSET	272	8817	MAGNETO	201	C0076	FORMENTERA	277	C0190	SAONA	262	XTS392	CARRILES TR	249				
8490	SAL ORO	60	8605	DAVOS DOUBLE	382	8684	ALGARVE	256	8780	SUNSET	272	8818	MAGNETO	205	C0077	FORMENTERA	277	C0191	SAONA	262	XTS402	CARRILES TR	249				
8491	SAL ORO	156	8606	DAVOS DOUBLE	382	8685	ALGARVE	256	8781	SUNSET	272	8819	MAGNETO	205	C0078	FORMENTERA	277	C0192	SAONA	263	XTS382	CARRILES TR	248				
8492	SAL ORO	156	8607	DAVOS DOUBLE	382	8686	ALGARVE	256	8782	SUNSET	272	8820	MAGNETO	204	C0083	METACRILATO	306	C0193	SAONA	263	XTSF103	CARRILES TR	247				
8493	SAL ORO	168	8608	DAVOS DOUBLE	382	8687	ALGARVE	256	8783	SUNSET	272	8821	MAGNETO	204	C0084	METACRILATO	306	C0194	SAONA	262	XTSF303	CARRILES TR	247				
8494	NELSON	18	8609	DAVOS XL	382	8688	LAGOS	288	8784	SUNSET	272	8822	MAGNETO	209	C0085	COLLIMBRES	192	C0195	SAONA	262	XTSF41003	CARRILES TR	246				
8495	NELSON	18	8610	DAVOS XL	382	8689	LAGOS	288	8785	SUNSET	272	8823	MAGNETO	208	C0101	BORA BORA	76	C0196	SAONA	263	XTSF42003	CARRILES TR	246				
8496	NELSON	18	8611	DAVOS XL	382	8731	CARRILES T	251	8786	SUNSET	272	8824	MAGNETO	207	C0102	BORA BORA	76	C0197	SAONA	263	XTS413	CARRILES TR	247				
8497	NELSON	18	8612	DAVOS XL	382	8732	CARRILES T	251	8787	SUNSET	272	8825	MAGNETO	209	C0103	BORA BORA	80				XTS123	CARRILES TR	247				
8498	TARIFA II	68	8649	TIRAS LED	320	8733	CARRILES T	252	8788	SUNSET	272	41002	CARRILES TR	246	C0104	BORA BORA	80	9953074	TIRAS LED	337	XTS113	CARRILES TR	247				
8499	TARIFA II	68	8650	TIRAS LED	320	8734	CARRILES T	252	8789	SUNSET	272	41002	CARRILES TR	246	C0117	BORA BORA	78	9955901	TIRAS LED	334	XTS112	CARRILES TR	247				
8500	TARIFA II	68	8654	TAVIRA	310	8735	CARRILES T	252	8790	SUNSET	272	41003	CARRILES TR	246	C0119	BORA BORA	76	9955905	TIRAS LED	335	XTS122	CARRILES TR	247				
8501	TARIFA II	68	8655	TAVIRA	310	8736	CARRILES T	252	8791	SUNSET	272	41003	CARRILES TR	246	C0120	BORA BORA	76	9955911	TIRAS LED	333	SPW11SK215	CARRILES TR	247				
8510	NASSAU	166	8656	TAVIRA	312	8737	CARRILES T	253	8792	SUNSET	272	42002	CARRILES TR	246	C0124	BORA BORA	78	9955912	TIRAS LED	332	SKB122	CARRILES TR	247				
8511	NASSAU	166	8657	TAVIRA	312	8738	CARRILES T	253	8793	SUNSET	272	42002	CARRILES TR	246	C0125	BORA BORA	78	9955921	TIRAS LED	336	XTS143	CARRILES TR	248				
8548	CARRILES T	250	8658	SPLIT	178	8739	CARRILES T	253	8794	SUNSET	272	42003	CARRILES TR	246	C0126	BORA BORA	78	11SK215	CARRILES TR	247	XTS213	CARRILES TR	248				
8549	CARRILES T	250	8659	SPLIT	178	8740	CARRILES T	253	8795	SUNSET	272	42003	CARRILES TR	246	C0127	BORA BORA	76	11SK315	CARRILES TR	247	XTSF102	CARRILES TR	247				
8550	CARRILES T	250	8660	KIEL	308	8741	CARRILES T	253	8796	SUNSET	272	C0001	BASICO GU10	294	C0128	BORA BORA	76				XTSF302	CARRILES TR	247				

Créditos

Dirección de arte

Vicente Moya
José Ignacio Ballester

Fotografías 3D

Javier Gilabert Photographer
Cualiti Photo Studio
Sergi Penalba
Estudios Aviñó

Diseño gráfico y Comunicación

Amparo Navarro
creativo@mantraco.org

MANTRA

Pol. Ind. Los Vientos
Calle Alisio, parcela nº4
46119 Náquera · Valencia · Spain
Tel. +34 96 160 99 50
info@mantraco.org

Depto. Nacional

Tel. +34 96 160 99 50
mar@mantraco.org

Depto. Internacional

Tel. +34 96 160 99 50
c.ando@mantraco.org

© copyright - Global Manufacturing and trading company S.L



watch MANTRA videos

