



BIG WHITE 2020

DAFÜR STEHEN WIR.



PREIS UND LEISTUNG
IN PERFEKTEM EINKLANG



SCHNELLE UND
ZUVERLÄSSIGE LIEFERUNG
24h (DEUTSCHLAND), 48h (EUROPA)



WIR SIND IHR WARENLAGER
98% VERFÜGBARKEIT

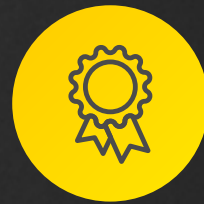

5 JAHRE GARANTIE *

VERTRIEB NATIONAL

Rufnummer:
+49 (0) 2451 4833 - 333

Faxnummer:
+49 (0) 2451 4188 - 0
+49 (0) 2451 4188 - 8

Mail:
info@slv.de

Montag bis Donnerstag:
08:00 – 18:00 Uhr

Freitag:
08:00 – 17:00 Uhr

TECHNISCHER KUNDENDIENST

Rufnummer:
+49 (0) 2451 4833 - 600

Faxnummer:
+49 (0) 2451 4833 - 519

Mail:
service@slv.de

Montag bis Donnerstag:
08:00 – 17:00 Uhr

Freitag:
08:00 – 14:30 Uhr

ZENTRALE

SLV GmbH
Daimlerstraße 21–23
52531 Übach-Palenberg

Rufnummer:
+49 (0) 2451 4833 - 0

Montag bis Freitag:
08:00 – 17:00 Uhr

slv.com

LOGISTIKCENTER

SLV GmbH
Werkstraße 8–10
52531 Übach-Palenberg

KUNDENZUFRIEDENHEIT

SLV wird Sie mit exzellentem Kundenservice und Lieferperformance begeistern! Unser engagiertes Team steht Ihnen für jedes Anliegen persönlich zur Verfügung!

Rufen Sie uns an (+49 (0) 2451 4833 - 333), kontaktieren Sie uns per E-Mail (info@slv.de) oder bestellen Sie direkt auf unserer Internetseite slv.com. Wir freuen uns auf Ihr Projekt!

KUNDENINFO

Bitte beachten Sie zudem unsere Rücksenderichtlinien und Reparaturbedingungen, die Sie auf unserer Internetseite slv.com/de-de/service/downloads finden.

Sofern keine anderweitigen Vereinbarungen bestehen, richten sich alle Lieferungen und Leistungen nach unseren Allgemeinen Geschäftsbedingungen, welche Sie auf unserer Internetseite slv.com/de-de/agb einsehen können.

*Bitte beachten Sie die Garantiebedingungen unter slv.com → Service → Downloads → Garantiebedingungen.



**SLV
VALETO®**



© bernardbodo, Adobe Stock

KOMPATIBEL MIT ANDEREN. VERBUNDEN MIT IHNEN.

Das SLV VALETO® SMART LIGHT SYSTEM macht Ihnen das Leben leichter. Sie haben die Möglichkeit das System mit Philips Hue, OSRAM SMART+ sowie weiteren ZigBee® 3.0 kompatiblen Systemen anderer Hersteller zu verbinden und mit Hilfe von Amazon Alexa über Sprachbefehle zu steuern.

Alle Möglichkeiten und alle Vorteile ab Seite 816.

LET'S GO DIGITAL

DAMIT SIE NOCH EFFIZIENTER ARBEITEN KÖNNEN

„UND WAS GENAU KANN DER NEUE WEBSHOP JETZT?“ EINE GANZE MENGE!



Bei der Neuausrichtung ging es nicht nur darum die Website gut aussehen zu lassen. Sie soll auch einiges leisten können. So hat nicht nur die Visualisierung unserer Produkte ein Upgrade bekommen, sondern auch die Suchergebnisse. Ein schnellerer Aufbau und ein intuitiveres Bedienen waren weitere Wünsche, die wir aufgenommen haben. Das alles wurde natürlich nicht nur für den Desktop optimiert, sondern auch für Smartphone & Tablet.

SUCHEN & FINDEN

Eine Produktsuche ist essentiell in einem Webshop. Deswegen haben wir uns hier besonders viel Mühe gegeben. Sinnvolle Filter und eine Vielzahl interner und externer Anregungen wurden hier mit den technischen Möglichkeiten schlauer Such-Algorithmen verwoben. So werden die Ergebnisse nicht nur schneller, sondern auch besser ausgespielt – kurzum: die Suche ist effizienter!

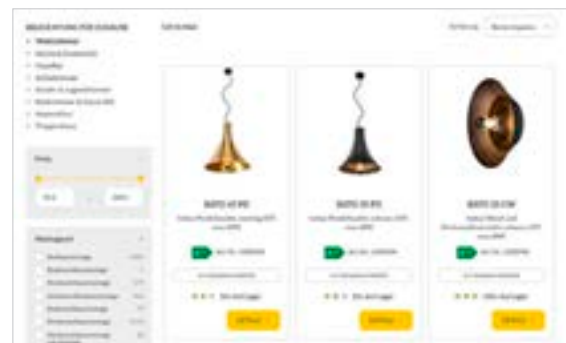

IHRE VISION – UNSERE LEUCHTEN



Licht ist so facettenreich, wie die Menschen, die mit ihm zu tun haben. Das spiegelt sich auch in unterschiedlichen Projekten wieder. Damit diese Wirklichkeit werden, geben wir Ihnen alle nötigen Tools und Daten an die Hand, die Sie benötigen. Egal ob Sie eine spezielle Software präferieren, oder ein bestimmtes Energie-Etikett brauchen: Wir stellen die nötigen Informationen gerne bereit.

ONLINE BLÄTTERN

Mit unserem Blätterkatalog haben Sie vielleicht schon Bekanntschaft gemacht. Falls nicht, möchten wir die Möglichkeit nicht verpassen, Ihnen noch einmal die Vorteile zu zeigen. Unter dem QR-Code finden Sie eine kurze Videoanleitung. Schauen Sie doch einmal rein!





INDOOR 006 - 527



Tisch- und Standleuchten..... 006 - 031
 Pendelleuchten 032 - 131
 Wandleuchten..... 132 - 229
 Deckenleuchten 230 - 277
 Wand- und Deckenleuchten 278 - 329



Hochvolt-Stromschiene 3Phasen..... 330 - 373
 Hochvolt-Stromschiene D-Track 374 - 381
 Hochvolt-Stromschiene 1Phasen..... 382 - 405
 Hochvolt-Stromschiene Easytec® II..... 406 - 415
 Niedervolt-Seilsystem und Vitrinenschiene 416 - 433



Einbauleuchten 434 - 527

OUTDOOR 528 - 735



Mobile Leuchten und Standleuchten..... 528 - 583
 Strahler..... 584 - 609
 Wandleuchten..... 614 - 671
 Deckenleuchten 672 - 679
 Wand- und Deckenleuchten 680 - 681



Wandeinbauleuchten..... 696 - 701
 Deckeneinbauleuchten 702 - 711
 Bodeneinbauleuchten 712 - 735

SICHERHEITSLÖSUNGEN 736 - 745



Sicherheitslösungen 736 - 745

PROFILLÖSUNGEN 746 - 777



LED-STRIPS UND LICHTBALKEN 778 - 815



LED-Strips 782 - 812
 Lichtbalken 813 - 815

SLV VALETO® SMART LIGHT SYSTEM | SLV LICHTSTEUERUNGEN 816 - 841



SLV VALETO® SMART LIGHT SYSTEM..... 816 - 825
 SLV LICHTSTEUERUNGEN Übersicht 826 - 827
 SLV COLOR CONTROL 828 - 831
 SLV KELVIN CONTROL 832 - 834
 SLV BLUETOOTH® CONTROL 835
 SLV CONTROL BY TRUST 836 - 841

ZUBEHÖR 842 - 865



Zubehör..... 842 - 865

LEUCHTMITTEL 866 - 881



Leuchtmittel 866 - 881

LEUCHTENFAMILIEN UND INDEX 882 - 918



Die SLV Leuchtenfamilien 882 - 899
 Numerisch 900 - 911
 Alphabetisch..... 912 - 917

Weitere Leuchten und Varianten finden Sie online unter www.slv.com

Alle Preisangaben verstehen sich als unverbindliche Preisempfehlungen (UVP) ohne MwSt.



ZEITLOSE KLASSIKER

PASSENDE TISCH- UND STANDLEUCHTEN
FÜR JEDEN RAUM.

Die Klassiker unter den Leuchten: Unsere Tisch- und Standleuchten fügen sich dank ihres schlichten und schlanken Designs in jedes Interieur ein und macht so im Büro, Wohnraum oder Ladengeschäft einfach immer eine gute Figur.

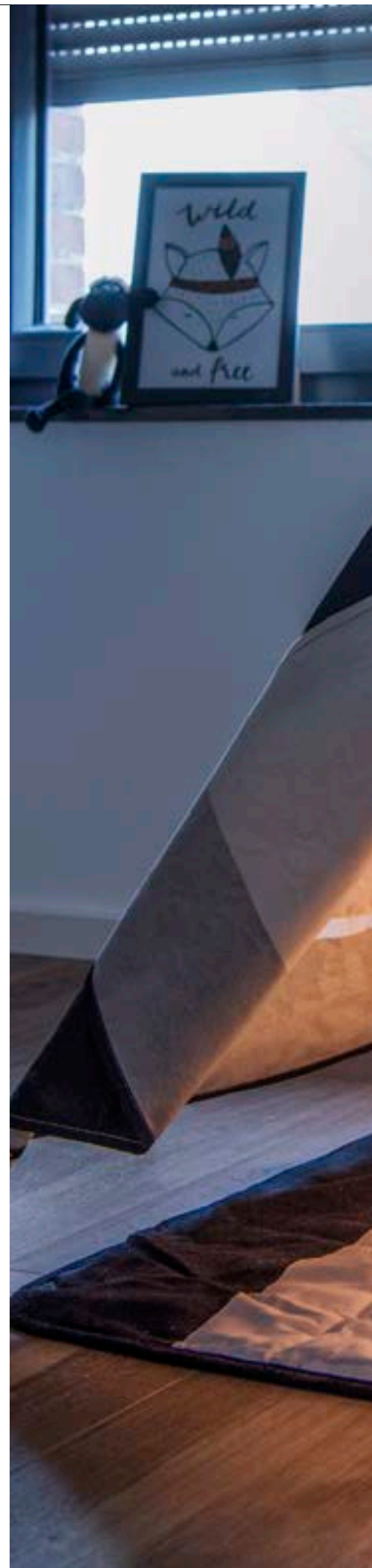



1002582 11

1002583 11

















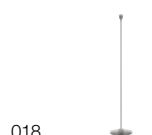



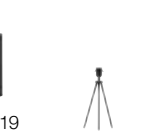





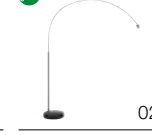



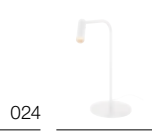

1002146 29

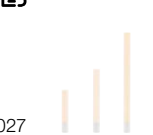

1003029 + 156122 22 + 22

TISCH- UND STANDLEUCHTEN

 010	 010	 011	 012	 012	 015	 018	 018
 018	 019	 019	 019	 020	 020	 020	 021
 021	 021	 022	 022	 022	 024	 024	 025
 025	 026	 026	 027	 027	 028	 029	 030
 031							

 Weitere Leuchten und Varianten finden Sie online unter www.slv.com

KALU
FL, single, QPAR111



E-A++ Spektrum A++-E

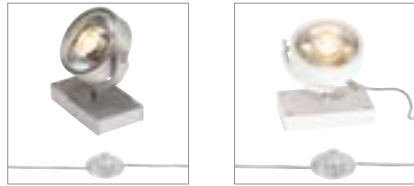

- Leuchteneinheit 350° dreh- und 90° schwenkbar
- Fußschalter an der Netzanschlussleitung

Produktangaben

220-240V ~50/60Hz
Material: Aluminium

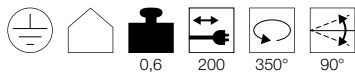

0,6 200 350° 90°

Maßzeichnung

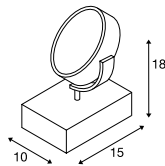

Hinweis

Schutzkontaktstecker und Schalter

Leuchtmittlempfehlung

LED GU10 6,5W 30°
2700K 400lm EEK=A+
7kWh/1000h

Art. Nr. 1000684



LED GU10 15,5W 30°
2700K 680lm EEK=A
16kWh/1000h

Art. Nr. 570672



Leuchtmittelangaben

max. 20W QPAR111

Variante	Art. Nr.
GU10 QPAR111	
■ schwarz	1000722
□ weiß	1000723
■ matt aluminium	1000724

FITU
TL, E27



E-A++ Spektrum A++-E



- Schalter an der Netzanschlussleitung

Produktangaben

220-240V ~50/60Hz
Material: Aluminium



0,3 200

Maßzeichnung

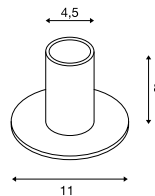

Hinweis

Eurostecker und Schalter

Leuchtmittlempfehlung

E27 8W
2000-2900K 500lm EEK=A
8kWh/1000h

Art. Nr. 560741



LED E27 8W 350°
2200K 250lm EEK=B
8kWh/1000h

Art. Nr. 1001357



Leuchtmittelangaben

max. 10W

Variante	Art. Nr.
E27	
■ schwarz	1001676
E27	
□ weiß	1001677
E27	
■ aluminium	1001678

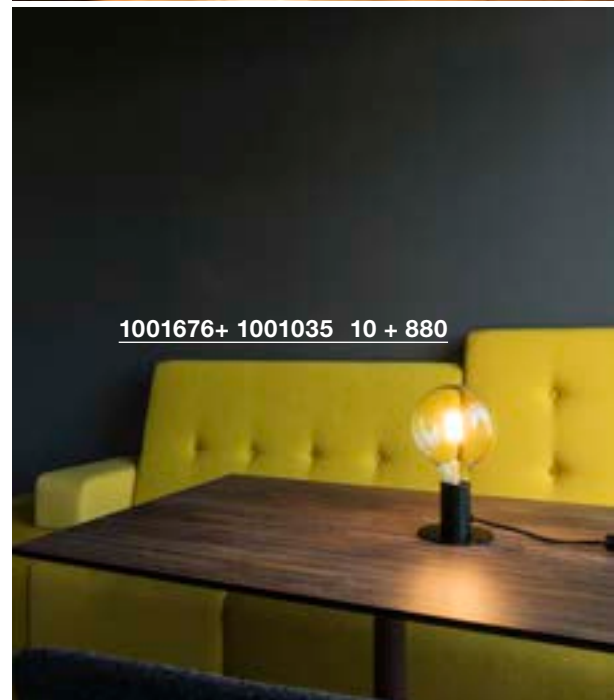

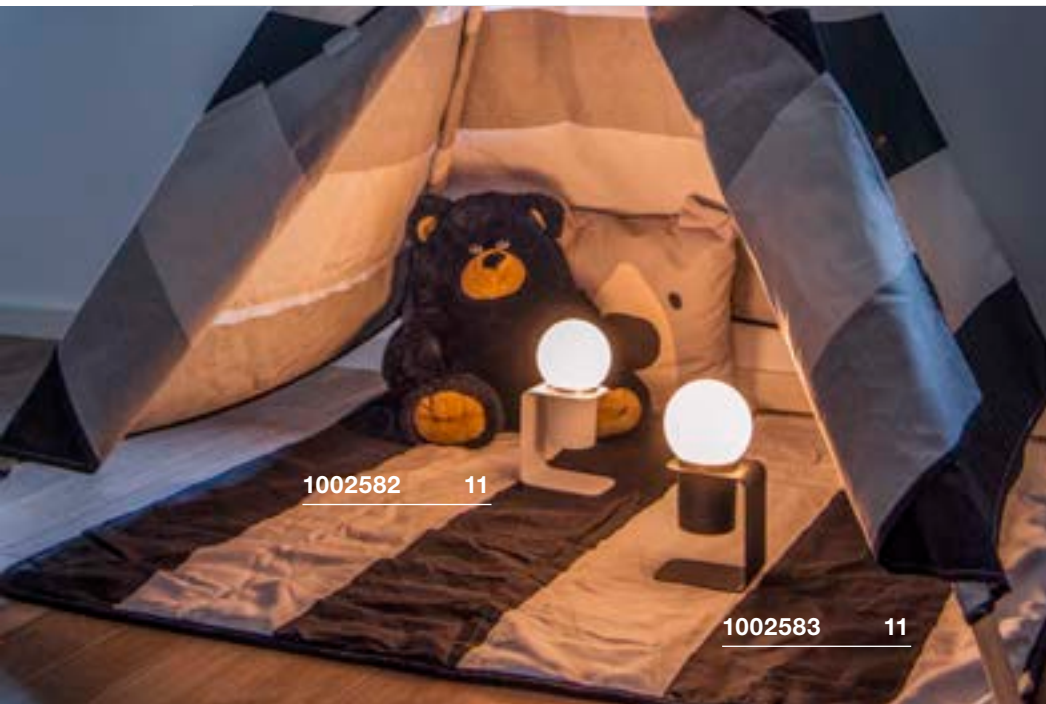

1002582 11

1002583 11

TONILA
TLA-A++ Spektrum
A++-ELED
INSIDE

NEW

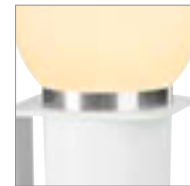

1002583 11

- Mobile kabellose Leuchte
- Durch den Taster in 3 Stufen dimmbar
- Komfortables Laden per USB

Produktangaben

Batteriebetrieb
Systemleistung: 1,6W
Material: Aluminium / Kunststoff
Dimmbar: Switch



Maßzeichnung

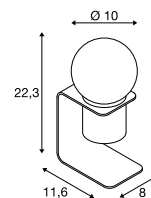

Hinweis

Netzteil exkl. USB Ladegerät 5V DC/1-2A benötigt.



1002583 11

Variante	Art. Nr.
90lm 2700K CRI>80 weiß / aluminium	1002582
90lm 2700K CRI>80 schwarz / messing	1002583



MAGANDA TL



A-A++ Spektrum A++-E



- Beleuchteter äußerer Rand
- Schalter am Leuchtenfuß
- 3 fach optische Vergrößerung

Produktangaben

100-240V ~50/60Hz | 12V DC
 Systemleistung: 4,2W
 Material: Stahl / Glas

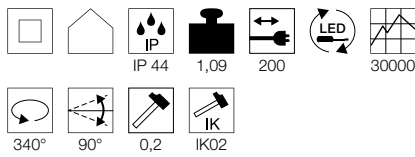

Maßzeichnung

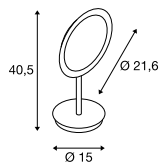

Hinweis

IP-Schutzkontaktstecker

VINCELLI D TL



A-A++ Spektrum A++-E



- Schlankes Design
- Leuchtenkorpus aus echtem Bambus

Produktangaben

220-240V ~50Hz | 500mA
 Systemleistung: 12W
 Material: Bambus / Stahl

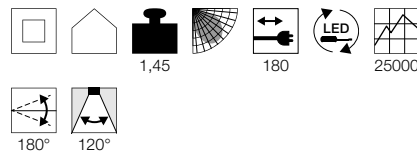

Maßzeichnung

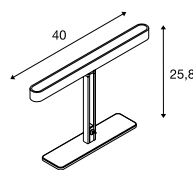

Hinweis

Steckernetzteil

1001502 12



Variante	Art. Nr.
70lm 3000K CRI>80 ■ chrom / weiß	1001502

Variante	Art. Nr.
500lm 2700K CRI>80 ■ anthrazit / braun	1002068

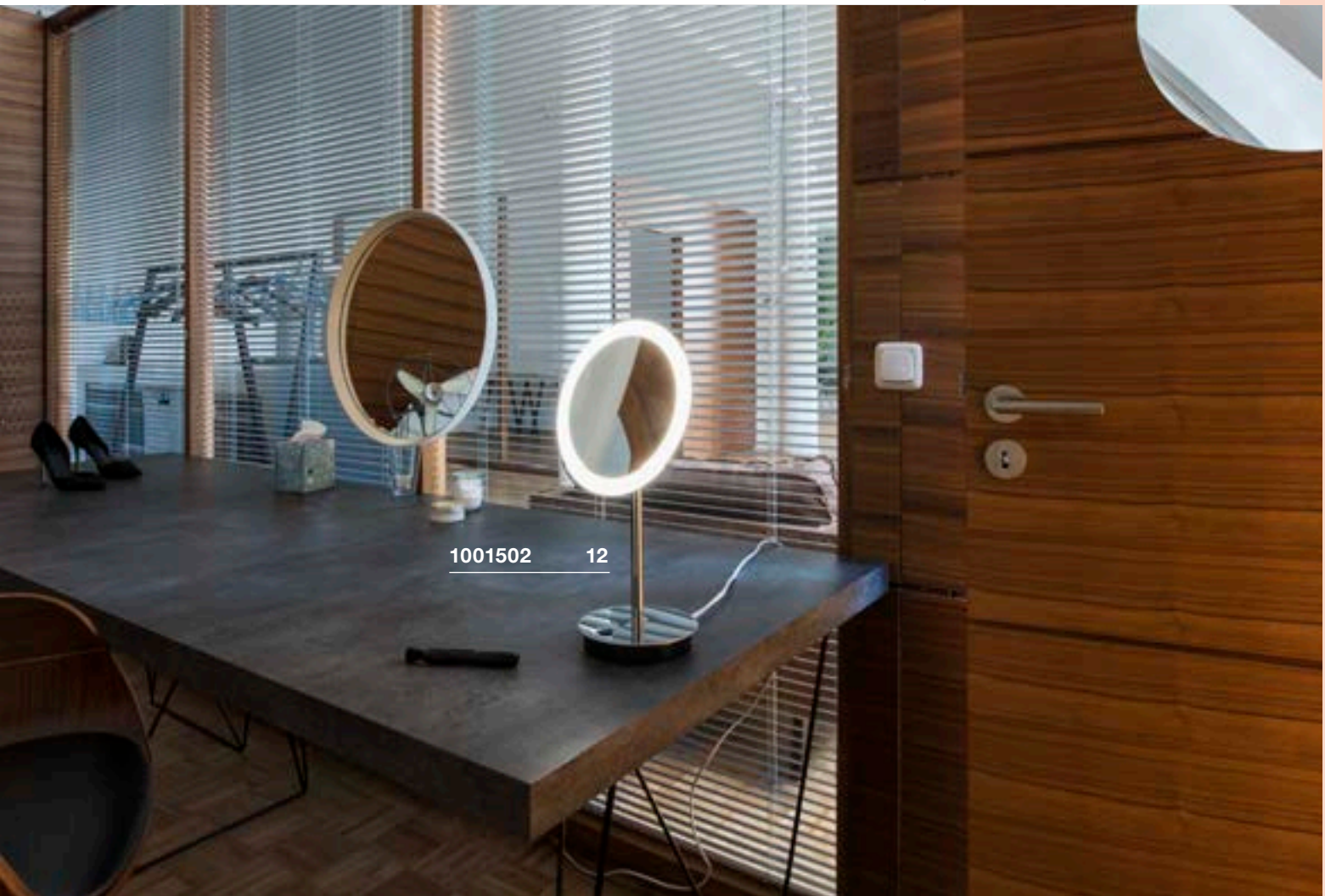

1001502 12



1002068 12



reddot award 2018
winner



DESIGNED BY

Johannes Tomm

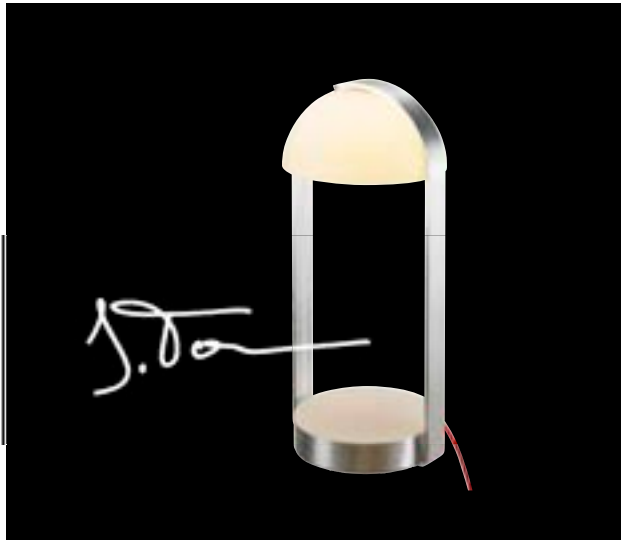



BRENDA
TL, Wireless charging



A-A++ Spektrum A++-E

LED INSIDE



- Dimmbar in drei Stufen
- Ladefläche zum kabellosen Auflad von Smartphones
- Premium LED und USB Anschluss

Produktangaben

220-240V ~50/60Hz | 12V DC
Systemleistung: 11W
Material: Aluminium / Glas
Dimmbar: Switch

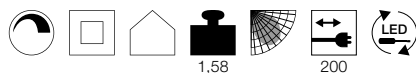

50000

Maßzeichnung

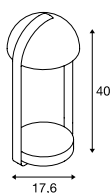

Hinweis

Nachtlich separat schaltbar
Eurostecker

Variante	Art. Nr.
Indirekt: 460lm 3000K CRI>80 Nachtlicht: 50lm 3000K CRI>80 ■ weiß / matt grau	146111



MODERNE TISCHLEUCHE MIT INDUKTIVER LADEFUNKTION

Red Dot Award Gewinner vereint modernes Design und Funktionalität.

Satiniertes Glas und Aluminium gebürstet – diese Mischung macht optisch den Unterschied. Diese ästhetischen Highlights werden abgerundet durch ein rotes Stromkabel.

Die in drei Stufen dimmbare Tischleuchte lässt sich durch Berührung an die aktuelle Stimmung und Umgebung anpassen. Zusätzlich bietet die BRENDA Tischleuchte eine zuschaltbare Nachtlicht Funktion (50 lm).

Doch nicht nur als hochwertige Design Tischlampe überzeugt die Brenda auf ganzer Linie. Die doppelte Smartphone Ladefunktion (induktive Ladestation + USB-Anschluss) hebt den Funktionsumfang auf ein neues Level und läutet eine neue Ära (Qi-fähiges Smartphone benötigt) ein.

Das integrierte Premium LED Modul mit einer Lebensdauer von 50.000 Stunden weiß bei höchster Sparsamkeit (EEK A++ bei 11 Watt) Maßstäbe zu setzen.

Die Brenda Familie ist eine Produktfamilie, die durch den renommierten Designer Johannes Tomm entworfen wurde: Wand- und Pendelleuchte sind ebenfalls erhältlich.

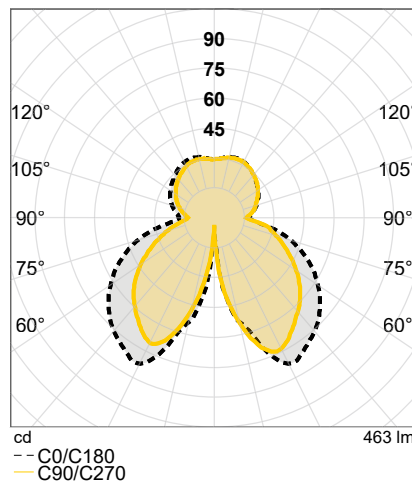



SLV FENDA. MIX & MATCH.

MIX & match

MIX & MATCH Video

bit.ly/slv-mix-match



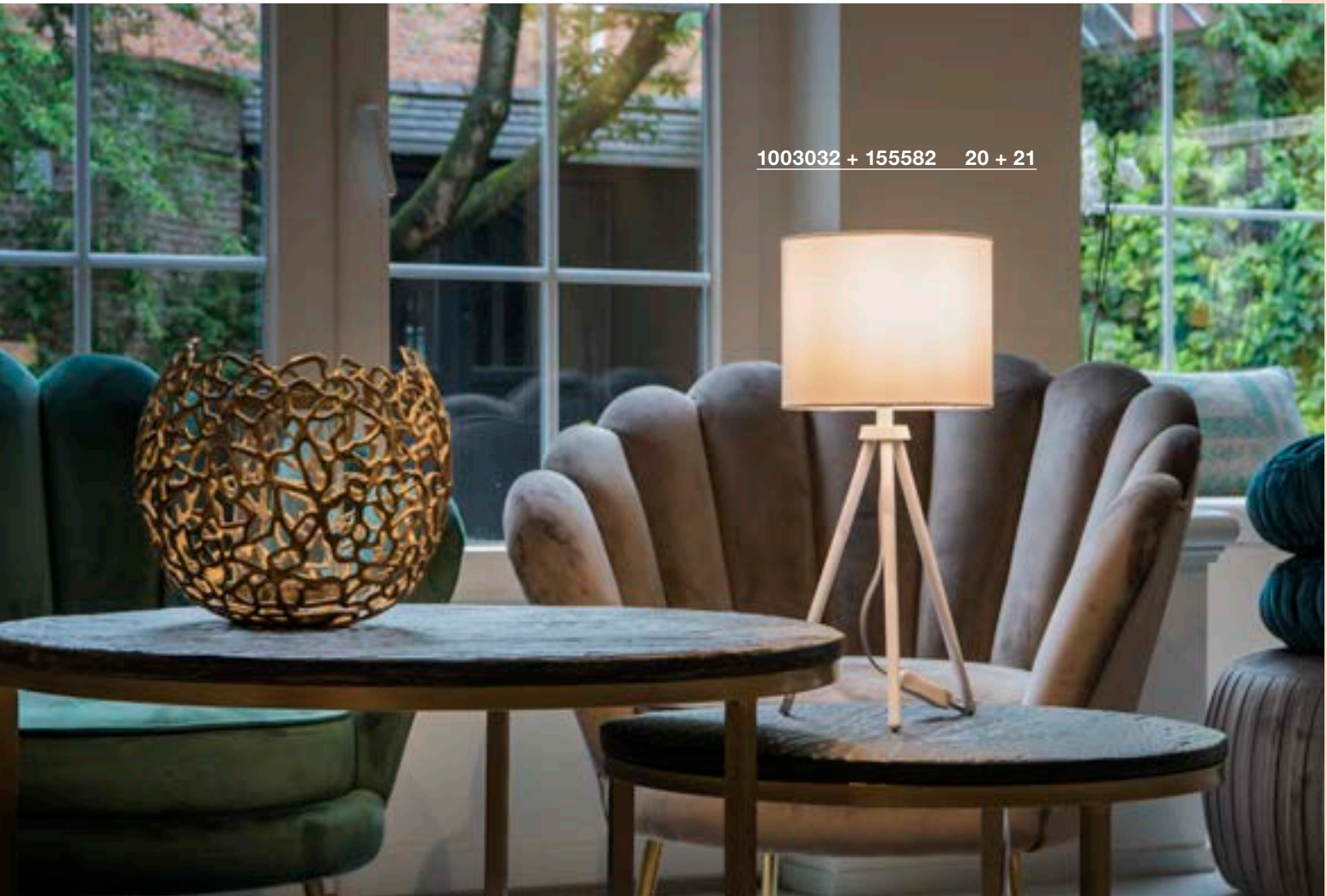

1003032 + 155582 20 + 21



1003029 + 156122 22

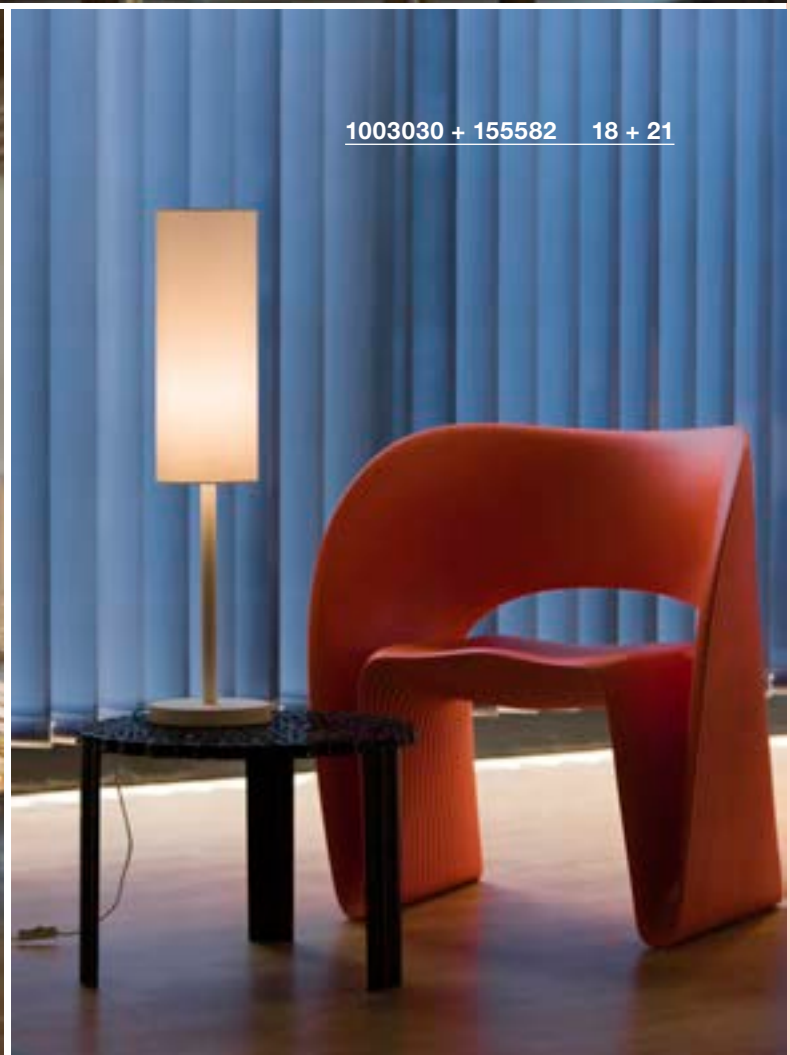

1003030 + 155582 18 + 21

FENDA
TL, E27



E-A++ Spektrum A++-E



- Durch Auswahl der Leuchtschirme individuell gestaltbar
- Schalter an der Netzanschlussleitung

Produktangaben

220-240V ~50/60Hz
Material: Stahl



1,95 200

Maßzeichnung

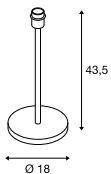

Hinweis

Eurostecker und Schalter

Leuchtmittlempfehlung

LED E27 14,5W 200°
2700K 1521lm EEK=A+
15kWh/1000h
Art. Nr. 560752



LED E27 7W
2700K 810lm EEK=A++
7kWh/1000h
Art. Nr. 1001038



Leuchtmittelangaben

max. 60W

Variante	Art. Nr.
E27	
□ matt weiß	1003030
E27	
■ matt schwarz	155780
E27	
▨ gebürstet nickel	155785

FENDA
FL, E27



E-A++ Spektrum A++-E



- Durch Auswahl der Leuchtschirme individuell gestaltbar
- Fußschalter an der Netzanschlussleitung

Produktangaben

220-240V ~50/60Hz
Material: Stahl



5,1 200

Maßzeichnung

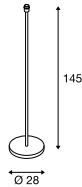

Hinweis

Eurostecker und Schalter

Leuchtmittlempfehlung

LED E27 11,5W 240°
2700K 1060lm EEK=A+
12kWh/1000h | 3 Step-Dim
Art. Nr. 560432



LED E27 9W 240°
2700-6500K 806lm EEK=A+
9kWh/1000h
Art. Nr. 1001916



Leuchtmittelangaben

max. 60W

Variante	Art. Nr.
E27	
□ matt weiß	1003031
E27	
■ matt schwarz	155790
E27	
▨ gebürstet nickel	155795

FENDA
Ø 15 cm, rund



- Durch Auswahl einer geeigneten Leuchtenbasis individuell gestaltbar

Produktangaben

Material: Textil / Stahl



0,22

Maßzeichnung

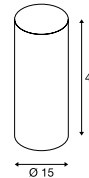

Hinweis

max. 40W



Variante	Art. Nr.
□ weiß	156141
■ beige	156143
■ schwarz / kupfer	156152



FENDA
Ø 30 cm, rund



- Durch Auswahl einer geeigneten Leuchtenbasis individuell gestaltbar

Produktangaben

Material: Textil / Stahl



Maßzeichnung

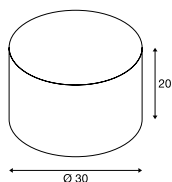

Hinweis

max. 60W



Variante	Art. Nr.
weiß	155582
beige	155583
schwarz / kupfer	155592

FENDA
Ø 45 cm, rund



- Durch Auswahl einer geeigneten Leuchtenbasis individuell gestaltbar

Produktangaben

Material: Textil / Stahl



Maßzeichnung

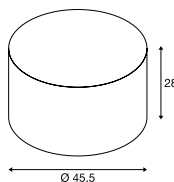

Hinweis

max. 60W



Variante	Art. Nr.
weiß	156111
beige	156113
schwarz / kupfer	156122

FENDA
Ø 70 cm, rund

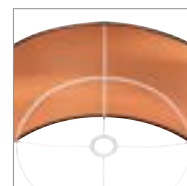

- Durch Auswahl einer geeigneten Leuchtenbasis individuell gestaltbar

Produktangaben

Material: Textil / Stahl



Maßzeichnung

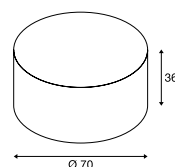

Hinweis

max. 60W

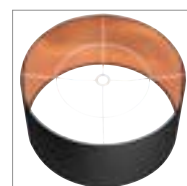
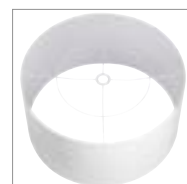

Variante	Art. Nr.
weiß	1000579
schwarz / kupfer	1000580

FENDA
TL, E27E-A++ Spektrum
A++-E

MIX & match

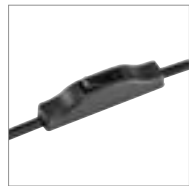

- Durch Auswahl der Leuchtschirme individuell gestaltbar
- Schalter an der Netzanschlussleitung

Produktangaben

220-240V ~50/60Hz
Material: Aluminium

Maßzeichnung

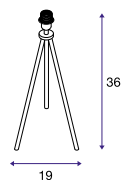

Hinweis

Eurostecker

Leuchtmittlempfehlung

LED E27 9,5W 240°
2200-6700K 806lm EEK=A+
10kWh/1000h
Art. Nr. 560161

Leuchtmittelangaben

max. 40W

Variante	Art. Nr.
E27	
■ matt weiß	1003032
E27	
■ matt schwarz	155540

FENDA
FL, E27E-A++ Spektrum
A+++-E

MIX & match

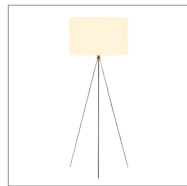

- Durch Auswahl der Leuchtschirme individuell gestaltbar
- Schalter am Leuchtenkopf

Produktangaben

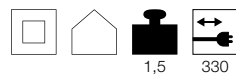
220-240V ~50/60Hz
Material: Aluminium

Maßzeichnung

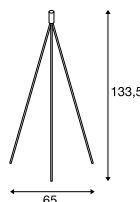

Hinweis

Eurostecker

Leuchtmittlempfehlung

LED E27 8,5W
2700K 806lm EEK=A+
10kWh/1000h
Art. Nr. 560161

Leuchtmittelangaben

max. 40W

Variante	Art. Nr.
E27	
■ matt weiß / glänzend schwarz	1003033
E27	
■ matt schwarz	155490
E27	
■ chrom	155492

FENDA
Ø 15 cm, rund

MIX & match



- Durch Auswahl einer geeigneten Leuchtenbasis individuell gestaltbar

Produktangaben

Material: Textil / Stahl



Maßzeichnung

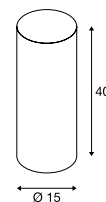

Hinweis

max. 40W



Variante	Art. Nr.
■ weiß	156141
■ beige	156143
■ schwarz / kupfer	156152



FENDA
Ø 30 cm, rund



- Durch Auswahl einer geeigneten Leuchtenbasis individuell gestaltbar

Produktangaben

Material: Textil / Stahl



Maßzeichnung

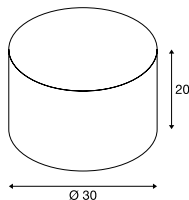

Hinweis

max. 60W



Variante	Art. Nr.
weiß	155582
beige	155583
schwarz / kupfer	155592

FENDA
Ø 45 cm, rund



- Durch Auswahl einer geeigneten Leuchtenbasis individuell gestaltbar

Produktangaben

Material: Textil / Stahl

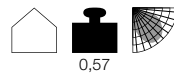

Maßzeichnung

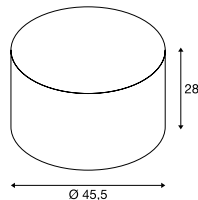

Hinweis

max. 60W

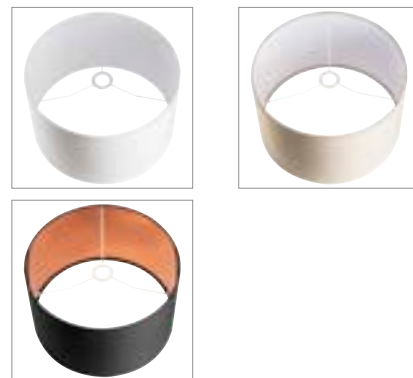

Variante	Art. Nr.
weiß	156111
beige	156113
schwarz / kupfer	156122

FENDA
Ø 70 cm, rund

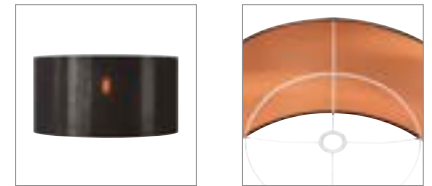

- Durch Auswahl einer geeigneten Leuchtenbasis individuell gestaltbar

Produktangaben

Material: Textil / Stahl

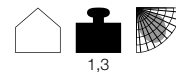

Maßzeichnung

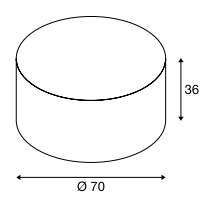

Hinweis

max. 60W

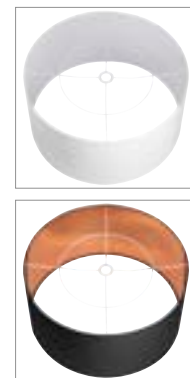

Variante	Art. Nr.
weiß	1000579
schwarz / kupfer	1000580

FENDA BOW BASIS
FL, E27

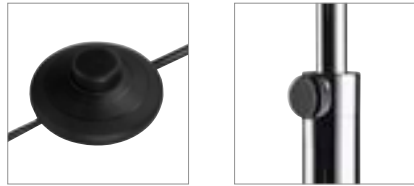

- Durch Auswahl der Leuchtschirme individuell gestaltbar
- Fußschalter an der Netzanschlussleitung

Produktangaben

220-240V ~50/60Hz
Material: Stahl



22 200 180°

Maßzeichnung

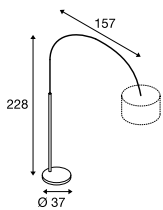

Hinweis

max. zulässiges Schirmgewicht 900 g
Eurostecker und Schalter

Leuchtmittelpfehlung

LED E27 9W 240°
2700-6500K 806lm EEK=A+
9kWh/1000h
Art. Nr. 1002127



LED E27 7W
2700K 810lm EEK=A++
7kWh/1000h
Art. Nr. 1001038



Leuchtmittelangaben

max. 25W
L: 17,5 cm max.

Variante	Art. Nr.
E27	
□ matt weiß	1003028
■ matt schwarz	1003029
E27	
■ chrom	1000763

FENDA
Ø 40 cm, rund

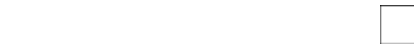

- Durch Auswahl einer geeigneten Leuchtenbasis individuell gestaltbar

Produktangaben

Material: Polymethylacrylat (PMMA)



0,5

Maßzeichnung

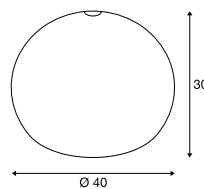

Hinweis

max. 60W

Variante	Art. Nr.
□ weiß	1000764

FENDA
Ø 45 cm, rund



- Durch Auswahl einer geeigneten Leuchtenbasis individuell gestaltbar

Produktangaben

Material: Textil / Stahl



0,57

Maßzeichnung

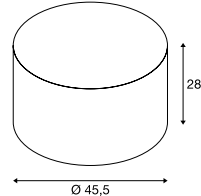

Hinweis

max. 60W



Zubehörepfehlung

Acrylglasabdeckung
Art. Nr. 156100

Variante	Art. Nr.
□ weiß	156111
■ beige	156113
■ schwarz / kupfer	156122



1003029 + 156122

22



1000763 + 1000764

22

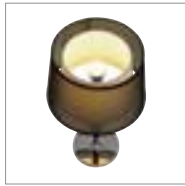
BISHADE
TL, E27E-A++ Spektrum
A++-E

- Doppelter konischer Leuchtschirm
- Schalter an der Netzanschlussleitung

Produktangaben

230V ~50Hz
Material: Kunstleder / Textil

Maßzeichnung

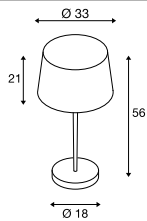

Hinweis

Eurostecker und Schalter

Leuchtmittelempfehlung

LED E27 9,1W 240°
2700K 760lm EEK=A+
10kWh/1000h
Art. Nr. 560402LED E27 11,5W 240°
2700K 1060lm EEK=A+
12kWh/1000h | 3 Step-Dim
Art. Nr. 560432

Leuchtmittelangaben

max. 25W
L: 15 cm max.

Variante	Art. Nr.
E27	
<input type="checkbox"/> transparent / weiß	155651

BISHADE
FL, E27E-A++ Spektrum
A++-E

- Doppelter konischer Leuchtschirm
- Fußschalter an der Netzanschlussleitung

Produktangaben

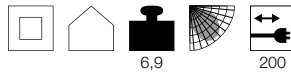
230V ~50Hz
Material: Kunstleder / Textil

Maßzeichnung

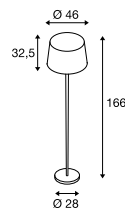

Hinweis

Eurostecker und Schalter

Leuchtmittelempfehlung

LED E27 14,5W 200°
2700K 1521lm EEK=A+
15kWh/1000h
Art. Nr. 560422LED E27 9W 240°
2700-6500K 806lm EEK=A+
9kWh/1000h
Art. Nr. 1001916

Leuchtmittelangaben

max. 40W
L: 22 cm max.

Variante	Art. Nr.
E27	
<input type="checkbox"/> transparent / weiß	155652

155651

24



155652

24



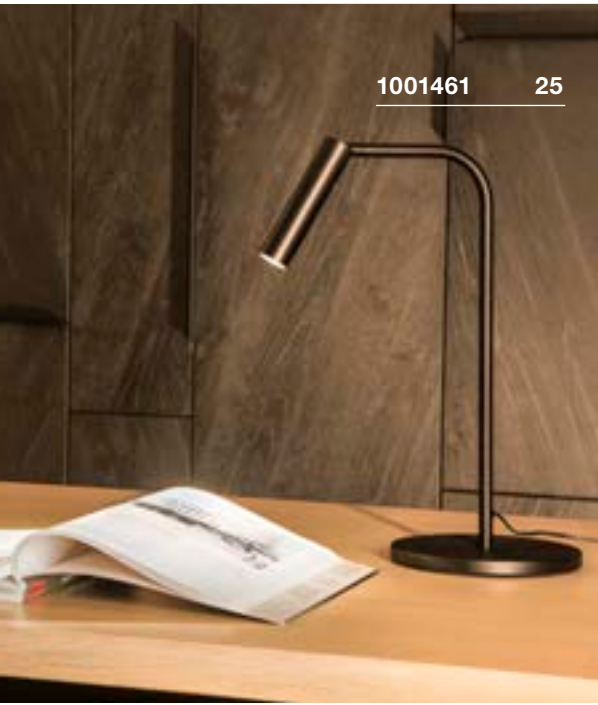

1001461 25

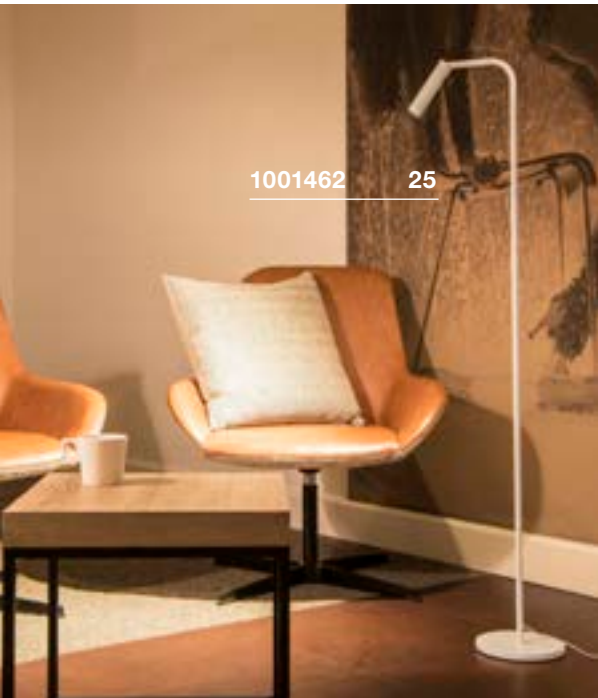

1001462 25



1001463 25

KARPO TL



A-A++ Spektrum A++-E



- Premium LED mit CRI>90
- Taster am Leuchtenkopf
- Durch den Taster in 3 Stufen dimmbar

Produktangaben

100-240V ~50/60Hz | 500mA
Systemleistung: 6,5W
Material: Aluminium
Dimmbar: Switch

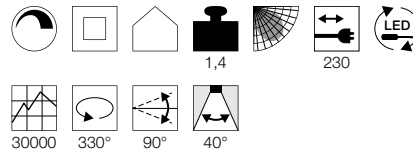

Maßzeichnung

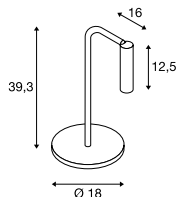

KARPO FL



A-A++ Spektrum A++-E



- Premium LED mit CRI>90
- Taster am Leuchtenkopf
- Durch den Taster in 3 Stufen dimmbar

Produktangaben

100-240V ~50/60Hz | 500mA
Systemleistung: 6,5W
Material: Aluminium
Dimmbar: Switch

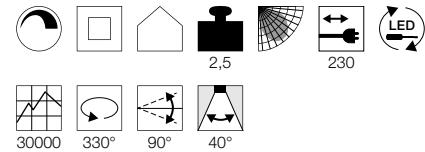

Maßzeichnung

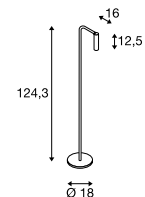

Variante	Art. Nr.
400lm 3000K CRI>90 □ weiß	1001460
330lm 3000K CRI>90 ■ schwarz	1001461

Variante	Art. Nr.
400lm 3000K CRI>90 □ weiß	1001462
330lm 3000K CRI>90 ■ schwarz	1001463

PHELIA
TL, QPAR51



E-A++ Spektrum A++-E



- Schalter am Leuchtenkopf
- Kopf 90° schwenkbar
- Leuchtschirm innen weiß lackiert

Produktangaben

230V ~50/60Hz
Material: Aluminium / Stahl

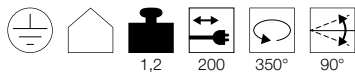

1,2 200 350° 90°

Maßzeichnung

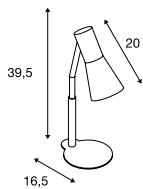

Hinweis

Schutzkontaktstecker und Schalter

Leuchtmittlempfehlung

LED GU10 5,5W 38°
2700K 400lm EEK=A+
6kWh/1000h
Art. Nr. 1001030



LED GU10 5,5W 36°
2800K 420lm EEK=A+
6kWh/1000h
Art. Nr. 1001217



Leuchtmittelangaben

max. 35W QPAR51
Ø: 5 cm max. L: 10,5 cm max.

Variante	Art. Nr.
GU10 QPAR51	
■ schwarz	146000
GU10 QPAR51	
□ weiß	146001

PHELIA
FL, E27



E-A++ Spektrum A++-E



- Schalter am Leuchtenkopf
- Kopf 90° schwenkbar
- Leuchtschirm innen weiß lackiert

Produktangaben

230V ~50/60Hz
Material: Aluminium / Stahl



6,3 200 350° 90°

Maßzeichnung

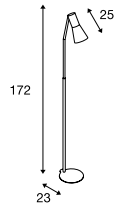

Hinweis

Schutzkontaktstecker und Schalter

Leuchtmittlempfehlung

LED E27 14,5W 200°
2700K 1521lm EEK=A+
15kWh/1000h
Art. Nr. 560422



LED E27 11,5W 240°
2700K 1060lm EEK=A+
12kWh/1000h | 3 Step-Dim
Art. Nr. 560432



Leuchtmittelangaben

max. 23W
Ø: 5,3 cm max. L: 18 cm max.

Variante	Art. Nr.
E27	
■ schwarz	146010
E27	
□ weiß	146011



146000

26

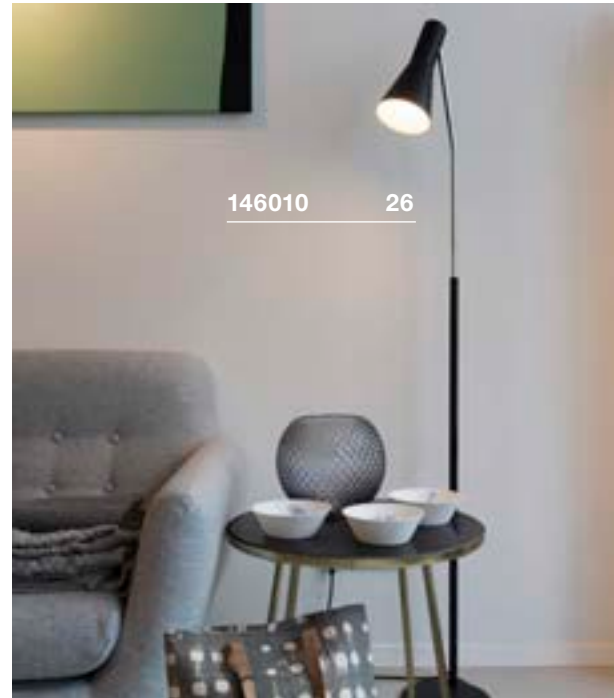

146010

26

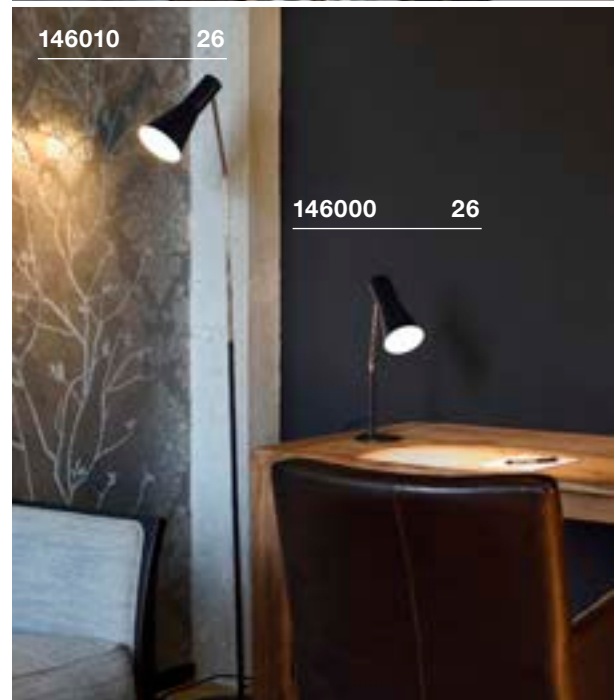

146010

26

146000

26

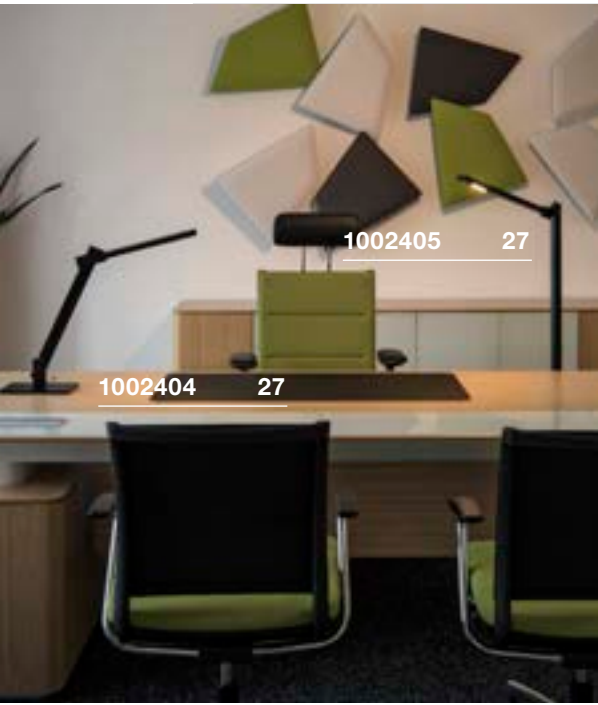

MECANICA PLUS
TL

A-A++ Spektrum A++-E
LED INSIDE
NEW VARIANT



- Dimmfunktion & Color Tuning

Produktangaben

100-240V ~50/60Hz | 12V DC
Systemleistung: 7W
Material: Aluminium
Dimmbar: Switch

3,2 200
30000 329° 306° 100°

Maßzeichnung

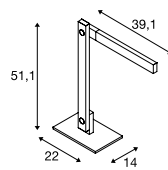

Hinweis

Steckernetzteil

Variante	Art. Nr.
450lm 2700-6500K CRI>80 ■ schwarz	1002404

MECANICA PLUS
FL

A-A++ Spektrum A++-E
LED INSIDE
NEW VARIANT



- Dimmfunktion & Color Tuning

Produktangaben

100-240V ~50/60Hz | 12V DC
Systemleistung: 7W
Material: Aluminium
Dimmbar: Switch

5,76 200
30000 329° 306° 100°

Maßzeichnung

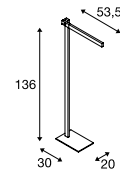

Hinweis

Steckernetzteil

Variante	Art. Nr.
450lm 2700-6500K CRI>80 ■ schwarz	1002405

LIGHT PIPE 60/90/140
Pole, TRIAC



A-A++ Spektrum
A++-E

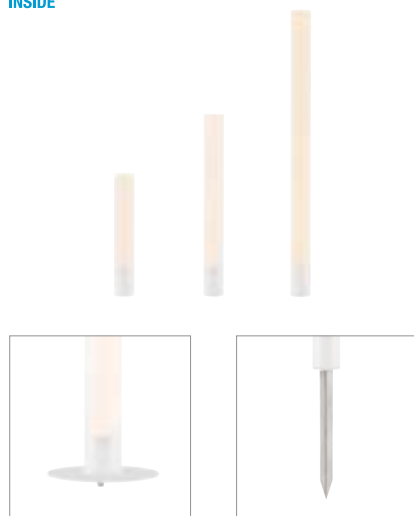

• Für innen und außen geeignet

Produktangaben

220-240V ~50/60Hz
Systemleistung: 11W
Material: Aluminium / Polymethylacrylat (PMMA)
Dimmbar: Triac C, Triac L

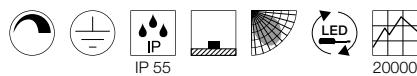

Maßzeichnung

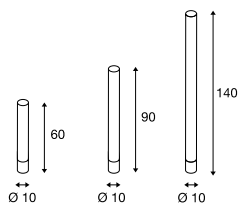

Hinweis

Die Leuchte wird ohne Montageplatte geliefert
Montageplatte indoor mit Fußschalter an der
Netzanschlussleitung
Montageplatte outdoor ohne Schalter, mit IP44
Schutzkontaktstecker

Zubehörempfehlung

Erdspieß

Art. Nr. 234430

Montageplatte outdoor

Art. Nr. 234431

Montageplatte indoor

Art. Nr. 234441



Variante	Art. Nr.
630lm 2700K CRI>80 H: 60 cm 1,5 kg <input type="checkbox"/> weiß	234401
630lm 2700K CRI>80 H: 90 cm 1,71 kg <input type="checkbox"/> weiß	234411
630lm 2700K CRI>80 H: 140 cm 2,06 kg <input type="checkbox"/> weiß	234421



234421

28

234411

28



234411

28

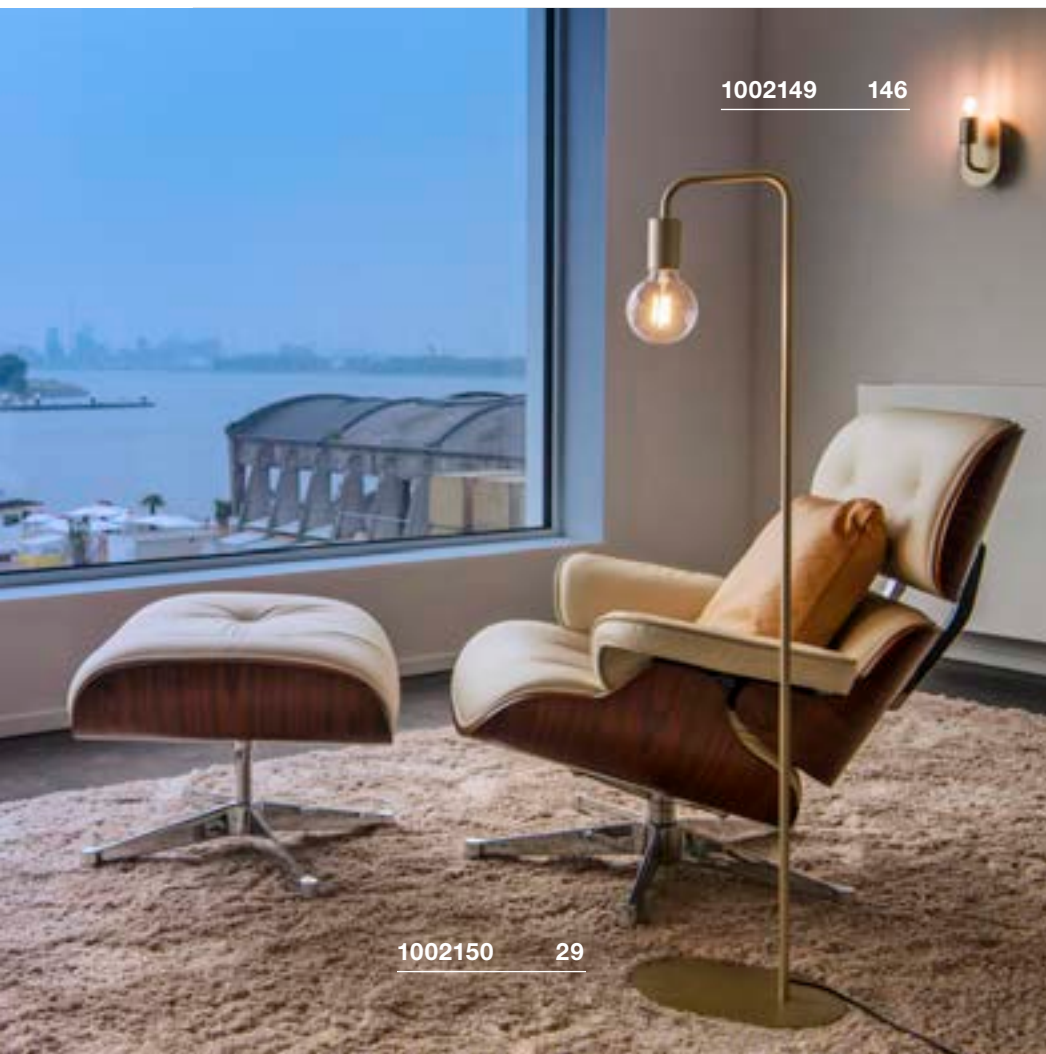

1002149 146

1002150 29

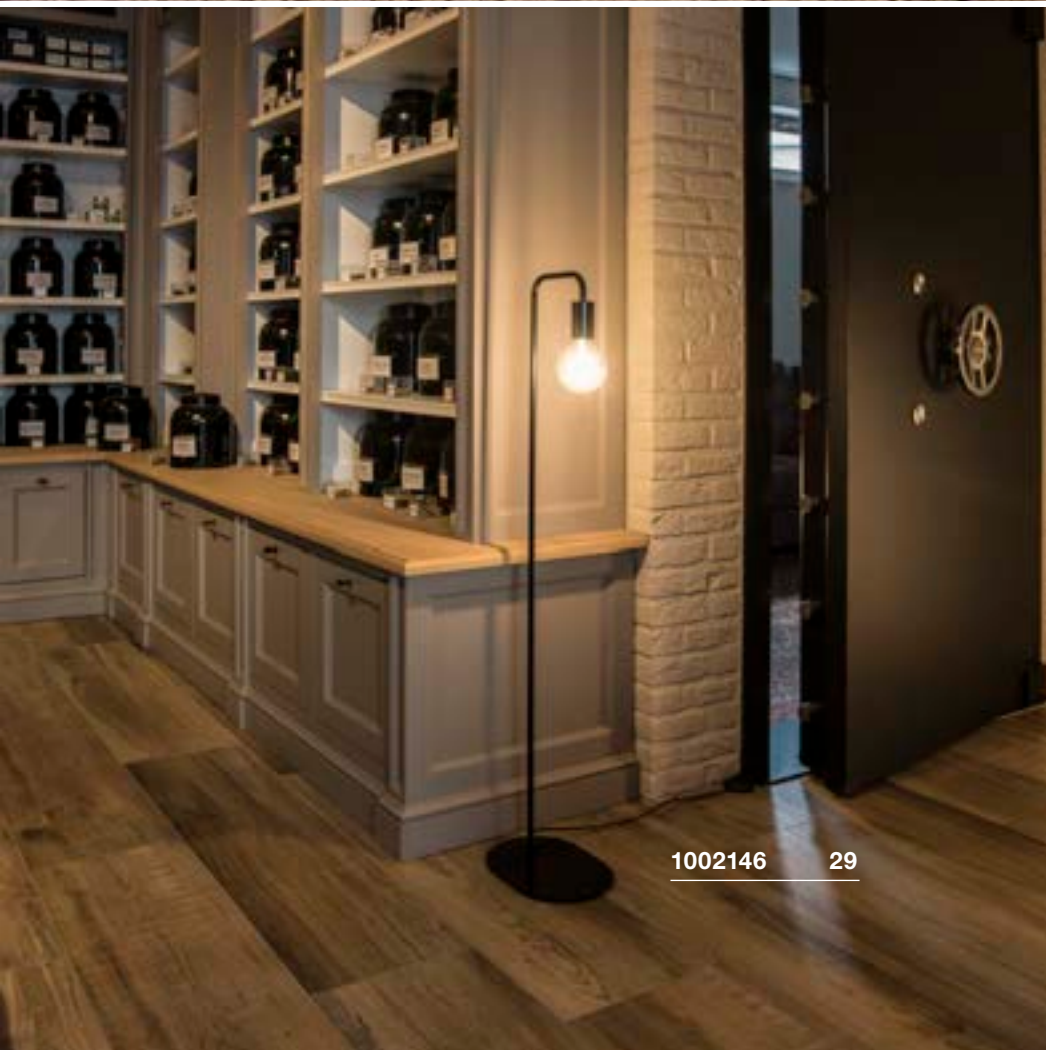

1002146 29

FITU
FL, E27

887

E-A++ Spektrum
A++-E

- Fußschalter an der Netzanschlussleitung

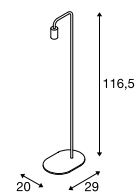
Produktangaben220-240V ~50/60Hz
Material: Aluminium / Stahl**Maßzeichnung****Hinweis**

Eurostecker und Schalter

LeuchtmittelempfehlungE27 5W 330°
2000K 500lm EEK=A+
5kWh/1000h
Art. Nr. 560741LED E27 7W 330°
2700K 806lm EEK=A+
8kWh/1000h
Art. Nr. 1001038**Leuchtmittelangaben**

max. 24W

Variante	Art. Nr.
E27 □ weiß	1002145
E27 ■ schwarz	1002146
E27 ■ gold	1002150



WORKLIGHT FL



898

A-A++ Spektrum
A++-E



- Schalter am Leuchtschaft
- Direktes und indirektes Licht

Produktangaben

220-240V ~50/60Hz | 226mA
 Systemleistung: 35W
 Material: Aluminium / Acryl

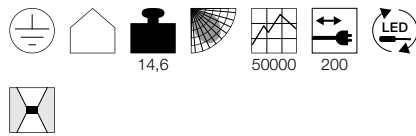

Maßzeichnung

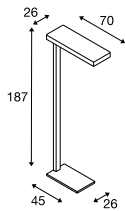

Hinweis

Schutzkontaktstecker

Variante	Art. Nr.
Direkt: 1850lm 3000K CRI>80 Indirekt: 1850lm 3000K CRI>80	157901
□ weiß	
Direkt: 1850lm 3000K CRI>80 Indirekt: 1850lm 3000K CRI>80	157905
■ anthrazit	





WORKLIGHT PLUS
FL, DALI



A-A++ Spektrum
A++-E



- Intelligente Anwesenheitssteuerung und Helligkeitssensorik
- Bildschirmarbeitsplatzgerecht gemäß EN 12464-1
- Direktes und indirektes Licht

Produktangaben

220-240V ~50/60Hz | 226mA
Systemleistung: 48W
Material: Aluminium / Acryl
Dimmbar: Dali

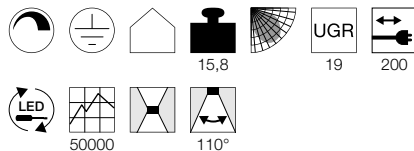

Maßzeichnung

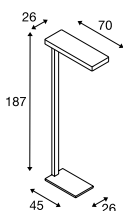

Hinweis

Schalter am Leuchtenschaft
Schutzkontaktstecker

Variante	Art. Nr.
Direkt: 3600lm 3000K CRI>80 Indirekt: 1800lm 3000K CRI>80	1002847
Direkt: 3600lm 3000K CRI>80 Indirekt: 1800lm 3000K CRI>80	1002848

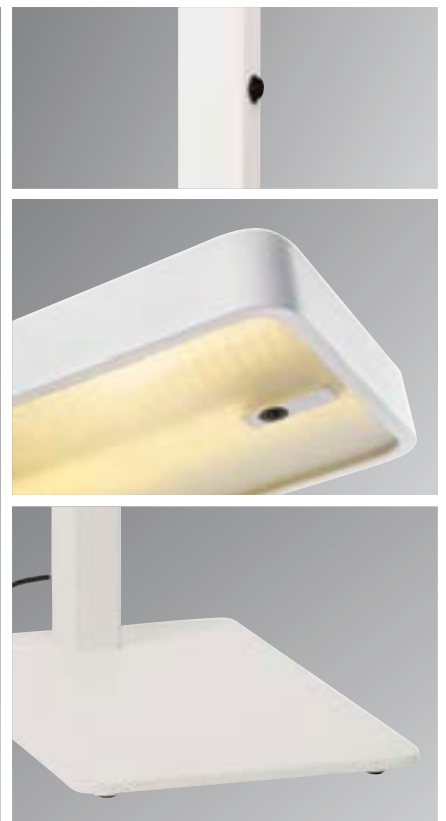
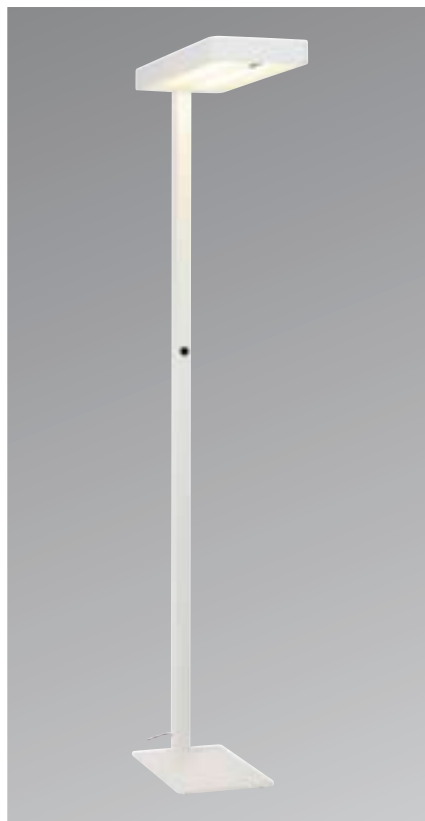

MOBILE & INTELLIGENTE ARBEITSPLATZLEUCHE FÜR DAS MODERNE BÜRO
Energieeffizient und langleb

Als konsequente Weiterentwicklung unserer WORKLIGHT Serie, erhalten Sie mit der DALI SENSOR Version eine mobile Arbeitsplatzleuchte für **Bildschirmarbeitsplätze (UGR ≤19)**, ausgestattet mit modernster Technik und **leistungsstarken LEDs mit einer Lebensdauer von 50.000 Stunden** aus dem Hause Philips. Durch die Ausstattung mit einer intelligenten Lichtsteuerung wird das Energieeinsparpotential optimiert. **Dank integrierter Anwesenheitssteuerung schaltet sich das Licht abhängig von einer Bewegung automatisch an und aus** und durch den Tageslichtsensor wird der Lichtstrom geregelt. Somit wird ein gleichbleibendes Lichtniveau am Arbeitsplatz sichergestellt.

Die Kombination aus **direkter und indirekter Lichtabgabe** sorgt für eine breite und gleichmäßige Ausleuchtung. Die Steuerung der Leuchte erfolgt direkt an der Leuchte (Taster). Die WORKLIGHT Familie ist eine Produktfamilie und auch als Pendelleuchte erhältlich.

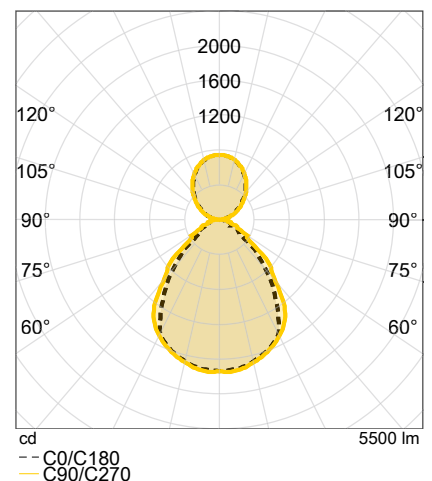
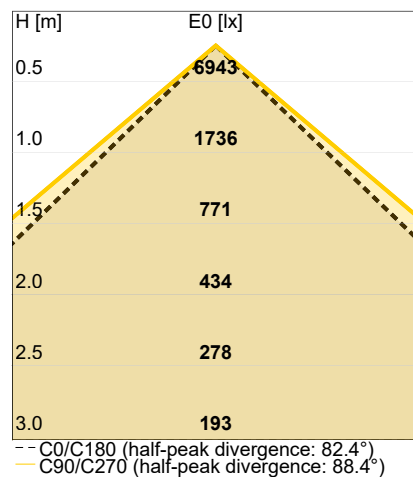

DA BLEIBEN BLICKE HÄNGEN.

PENDELLEUCHTEN SETZEN AKZENTE.

Geben Sie jedem Raum eine individuelle Note: Mit Pendelleuchten tauchen Sie ausgewählte Bereiche in atmosphärisches Licht und setzen, dank verschiedenster Stilrichtungen, optische Highlights. Ob in Restaurants, Cafés, Bars oder zuhause – die Leuchten schaffen Orte der Gemütlichkeit und setzen geschmackvolle Statements.





143430

57

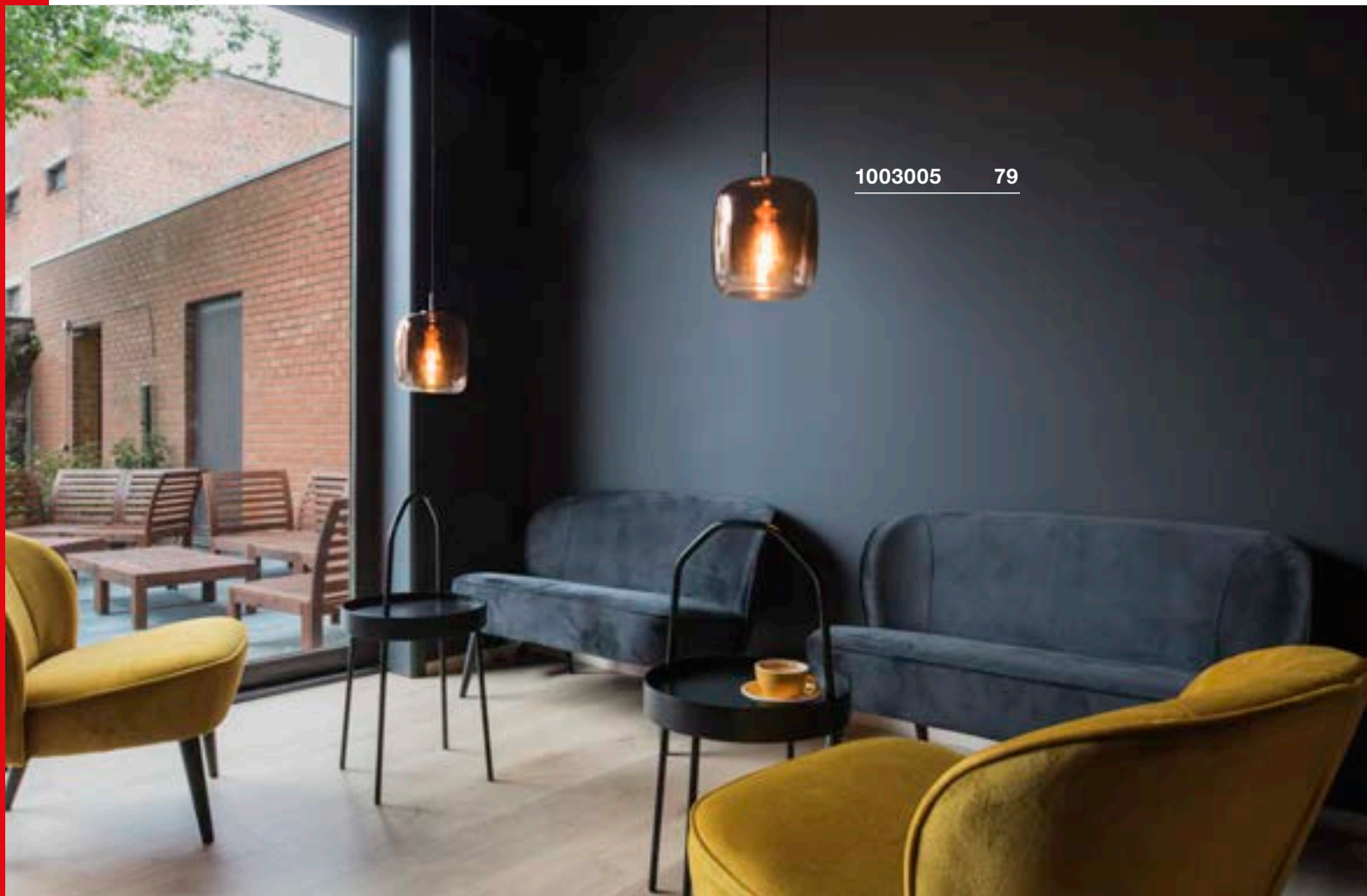

1003005 79

PENDELLEUCHTEN

							
036	036	037	038	039	044	044	044
							
046	047	047	047	048	049	049	050
							
050	053	053	053	055	055	056	057
							
057	057	058	058	058	059	061	061
							
062	062	062	065	065	066	066	066



Weitere Leuchten und Varianten finden Sie online unter www.slv.com

FITU
PD, E27



E-A++ Spektrum
A++-E



- Leuchtenkörper aus echtem Bambus
- Frei kombinierbar mit Fitu Deckenrosetten und unserem Zubehör

Produktangaben

220-240V ~50/60Hz
Material: Bambus / Stahl



Maßzeichnung

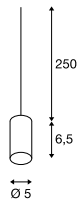

Hinweis

Textilkabel
Offenes Kabelend

Leuchtmittlempfehlung

LED E27 7W 280°
2200-2700K 830lm EEK=A++
7kWh/1000h

Art. Nr. 1002126



LED E27 7W 330°
2700K 630lm EEK=A+
8kWh/1000h

Art. Nr. 1001357



Leuchtmittelangaben

max. 60W

Variante	Art. Nr.
E27 ■ anthrazit / braun	1000581

FITU
PD, E27



E-A++ Spektrum
A+++-E



- 2,5 m langes Kabel
- Frei kombinierbar mit Fitu Deckenrosetten und unserem Zubehör

Produktangaben

220-240V ~50/60Hz
Material: Aluminium



Maßzeichnung

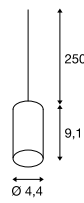

Hinweis

Textilkabel
Offenes Kabelend

Leuchtmittlempfehlung

LED E27 5W 330°
2000K 500lm EEK=A+
5kWh/1000h

Art. Nr. 560741



Leuchtmittelangaben

max. 60W

Variante	Art. Nr.
E27 ■ schwarz	132650
E27 □ weiß	132651
E27 ■ gold	1002167

1000581 36



132600 + 132650 40 + 36





132600 + 132650 40 + 36

FITU
PD, E27E-A++ Spektrum
A++-E

- 5 m langes Kabel
- Frei kombinierbar mit Fitu Deckenrosetten und unserem Zubehör

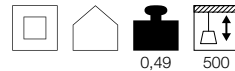
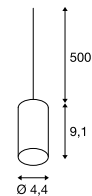
Produktangaben220-240V ~50/60Hz
Material: Aluminium**Maßzeichnung****Hinweis**Textilkabel
Offenes Kabelend**Leuchtmittlempfehlung**LED E27 7W 330°
2700K 806lm EEK=A+
8kWh/1000h

Art. Nr. 1001035

LED E27 7W 280°
2200-2700K 830lm EEK=A++
7kWh/1000h

Art. Nr. 1002126

**Leuchtmittelangaben**

max. 60W

Variante	Art. Nr.
E27	
■ schwarz	132690
E27	
□ weiß	132691
E27	
■ gold	1002168

FITU
PD, E27

887

E-A++

Spektrum
A++-E

- 2,5 m langes Kabel
- Frei kombinierbar mit Fitu Deckenrosetten und unserem Zubehör
- Extra langer Leuchtenkörper

Produktangaben

220-240V ~50/60Hz
Material: Aluminium



0,54 250

Maßzeichnung

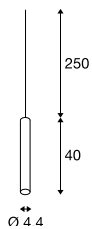

Hinweis

Textilkabel
Offenes Kabelend
Kombinierbar mit dem Zubehör Fitu Mix & Match auf Seite 40

Leuchtmittlempfehlung

LED E27 7W 280°
2700K 790lm EEK=A++
7kWh/1000h

Art. Nr. 1002124



LED E27 7W 330°
2700K 630lm EEK=A+
8kWh/1000h

Art. Nr. 1001357



Leuchtmittelangaben

max. 60W

Variante	Art. Nr.
E27	
■ schwarz	1002159
E27	
□ weiß	1002160
E27	
■ gebürstet aluminium	1002161
E27	
■ gold	1002162

1002162 38



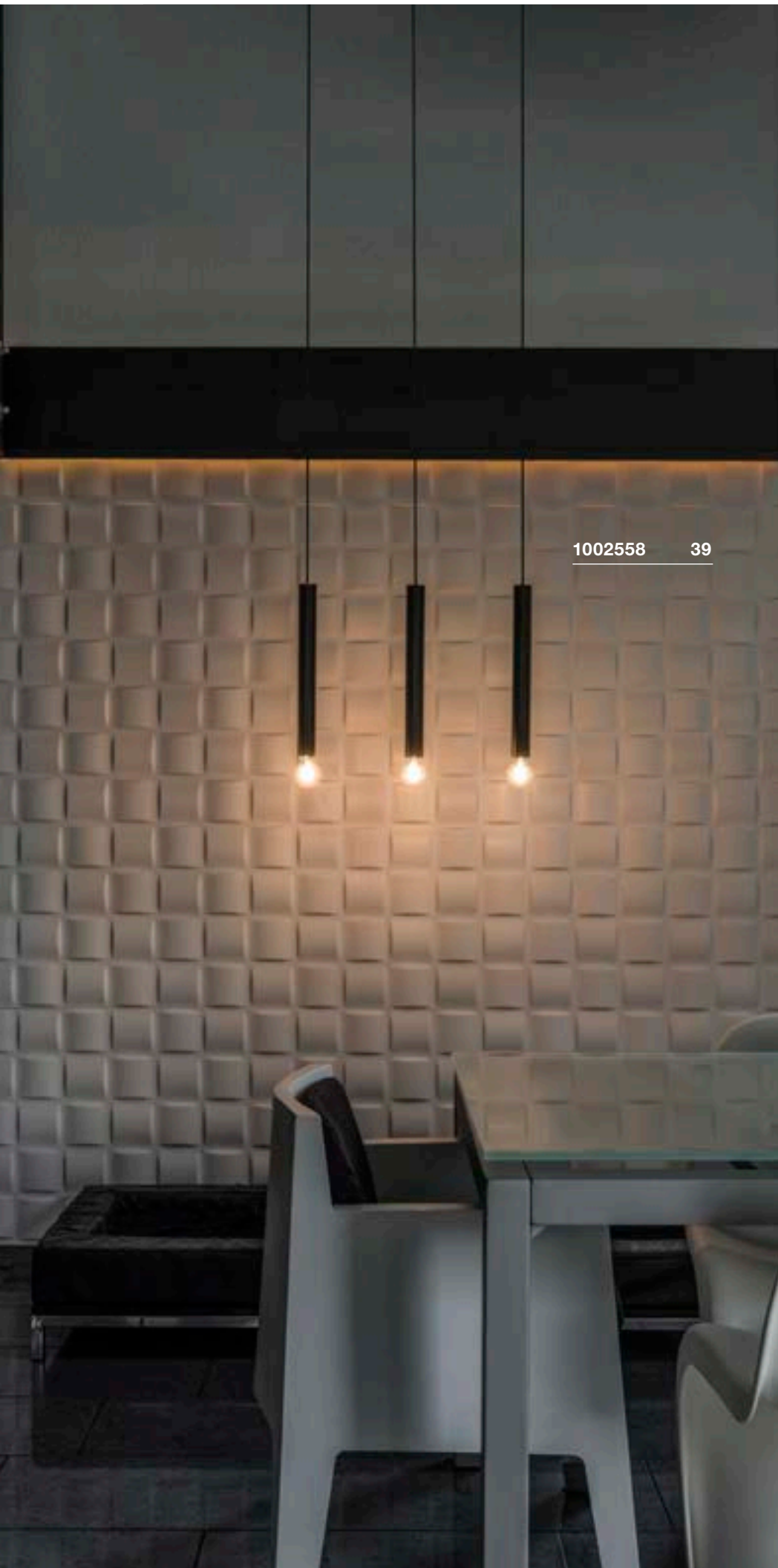

1002558 39

FITU
PD, E27E-A++ Spektrum
A++-ENEW
VARIANT

- 5 m langes Kabel
- Frei kombinierbar mit Fitu Deckenrosetten und unserem Zubehör

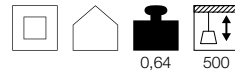
Produktangaben220-240V ~50/60Hz
Material: Aluminium

0,64 500

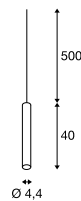
Maßzeichnung**Hinweis**

Textilkabel
Offenes Kabelend
Kombinierbar mit dem Zubehör Fitu Mix & Match auf Seite 40

Leuchtmittlempfehlung

LED E27 7W 280°
2700K 790lm EEK=A++
7kWh/1000h
Art. Nr. 1002124



LED E27 7W 330°
2700K 630lm EEK=A+
8kWh/1000h
Art. Nr. 1001357

**Leuchtmittelangaben**

max. 60W

Variante	Art. Nr.
E27	
■ schwarz	1002558
E27	
□ weiß	1002562
E27	
■ gebürstet aluminium	1002563
E27	
■ gold	1002564

ZUBEHÖR FITU MIX & MATCH

Fitu 1er Deckenrosette

16A max.
Stahl
Ø: 8,5 cm H: 3,9 cm
0,14 kg
1 Stk.



Variante	Art. Nr.
■ schwarz	132600
□ weiß	132601
■ chrom	132605
■ gold	1002163

Fitu 3er Deckenrosette

Stahl
1,08 kg
L: 60 cm B: 8,5 cm H: 5 cm
Befestigungsmaterial inkl.



Variante	Art. Nr.
■ schwarz	1001818
□ weiß	1001819
■ gold	1002264

1-Phasen Leuchtenadapter

230V ~50Hz, 6A max.
Kunststoff P
L: 8,2 cm B: 3,5 cm H: 4,2 cm
0,04 kg
Max. mechanische Belastung 3 kg
1 Stk.



Variante	Art. Nr.
■ schwarz	143120
□ weiß	143121
■ silbergrau	143124

Fitu 3er Deckenrosette

16A max.
Stahl
Ø: 22 cm H: 5,4 cm
0,5 kg
1 Stk.



Variante	Art. Nr.
■ schwarz	132610
□ weiß	132611
■ chrom	132615
■ gold	1002164

Fitu 5er Deckenrosette

Stahl
2,06 kg
L: 120 cm B: 8,5 cm H: 5 cm
Befestigungsmaterial inkl.



Variante	Art. Nr.
■ schwarz	1001820
□ weiß	1001821
■ gold	1002265

3-Phasen Leuchtenadapter

230V ~50Hz, 10A max.
Kunststoff
0,07 kg
Max. mechanische Belastung 5 kg
1 Stk.



Variante	Art. Nr.
■ schwarz	145990
□ weiß	1001542
■ silbergrau	145994

Fitu 5er Deckenrosette

16A max.
Stahl
Ø: 33 cm H: 6 cm
1,25 kg
1 Stk.



Variante	Art. Nr.
■ schwarz	132620
□ weiß	132621
■ chrom	132625
■ gold	1002165

Deckenhaken

16A max.
Stahl
L: 60 cm B: 8,5 cm H: 5 cm
Gewicht: 1,08 kg
1 Stk.



Variante	Art. Nr.
■ schwarz	132670
□ weiß	132671

Kabelklemme

16A max.
Stahl
L: 60 cm B: 8,5 cm H: 5 cm
Gewicht: 1,08 kg
1 Stk.



Variante	Art. Nr.
■ schwarz	132680
□ weiß	132681

132690 37



1002159 + 1001820 38 + 40

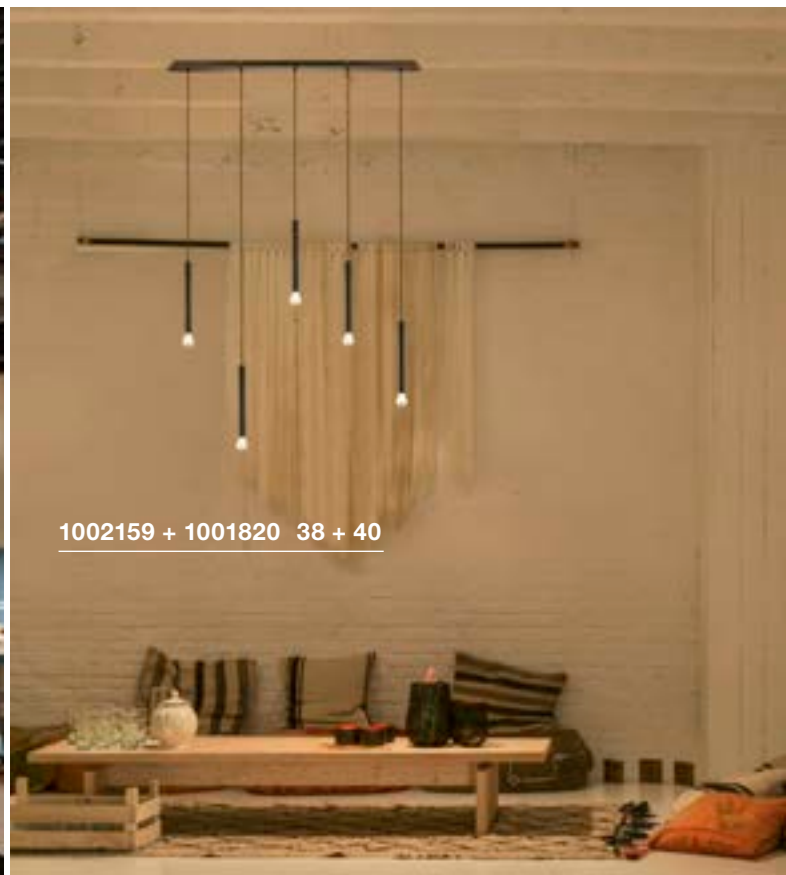



1002162 + 1002165 38 + 40



SLV FENDA. MIX & MATCH.

MIX & match

MIX&MATCH Video

bit.ly/slv-mix-match



132662 + 156122 44 + 47



132660 + 1000580 44 + 46



1000773 + 132661 44

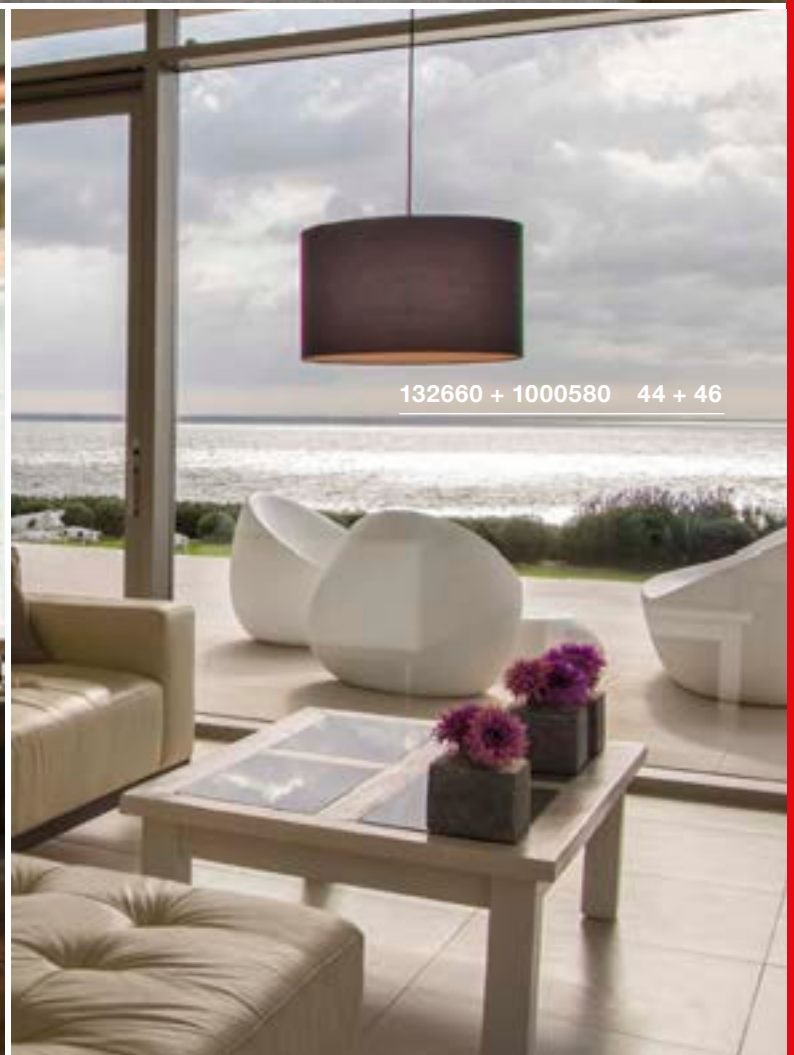

132660 + 1000580 44 + 46

FENDA
PD, E27



E-A++ Spektrum A++-E



• Durch Auswahl der Leuchtschirme individuell gestaltbar

Produktangaben

230V ~50Hz
Material: Stahl / Kunststoff



Maßzeichnung

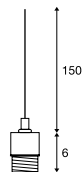

Hinweis

Offenes Kabelend

Zubehöreffempfehlung

■ 1-Phasen Leuchtenadapter
Art. Nr. 143120



■ 3-Phasen Leuchtenadapter
Art. Nr. 145990



Leuchtmittelpfehlung

LED E27 7W 280°
2700K 790lm EEK=A++
7kWh/1000h
Art. Nr. 1002124



LED E27 7W 280°
2200-2700K 830lm EEK=A++
7kWh/1000h
Art. Nr. 1002126



Leuchtmittelangaben

max. 60W

Variante	Art. Nr.
E27 ■ schwarz	132660
E27 □ weiß	132661
E27 ■ chrom	132662

FENDA
Glasschirm



• Durch Auswahl einer geeigneten Leuchtenbasis individuell gestaltbar

Produktangaben

Material: Glas



Maßzeichnung

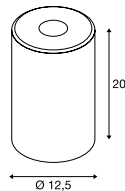

Hinweis

max. 40W
Kombinierbar mit dem Zubehör Fitu Mix & Match auf Seite 40

Variante	Art. Nr.
■ braun transparent	1000773
□ weiß	1002217

FENDA
Ø 40 cm, rund



• Durch Auswahl einer geeigneten Leuchtenbasis individuell gestaltbar

Produktangaben

Material: Polymethylacrylat (PMMA)



Maßzeichnung

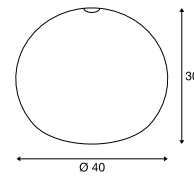

Hinweis

max. 60W

Variante	Art. Nr.
□ weiß	1000764

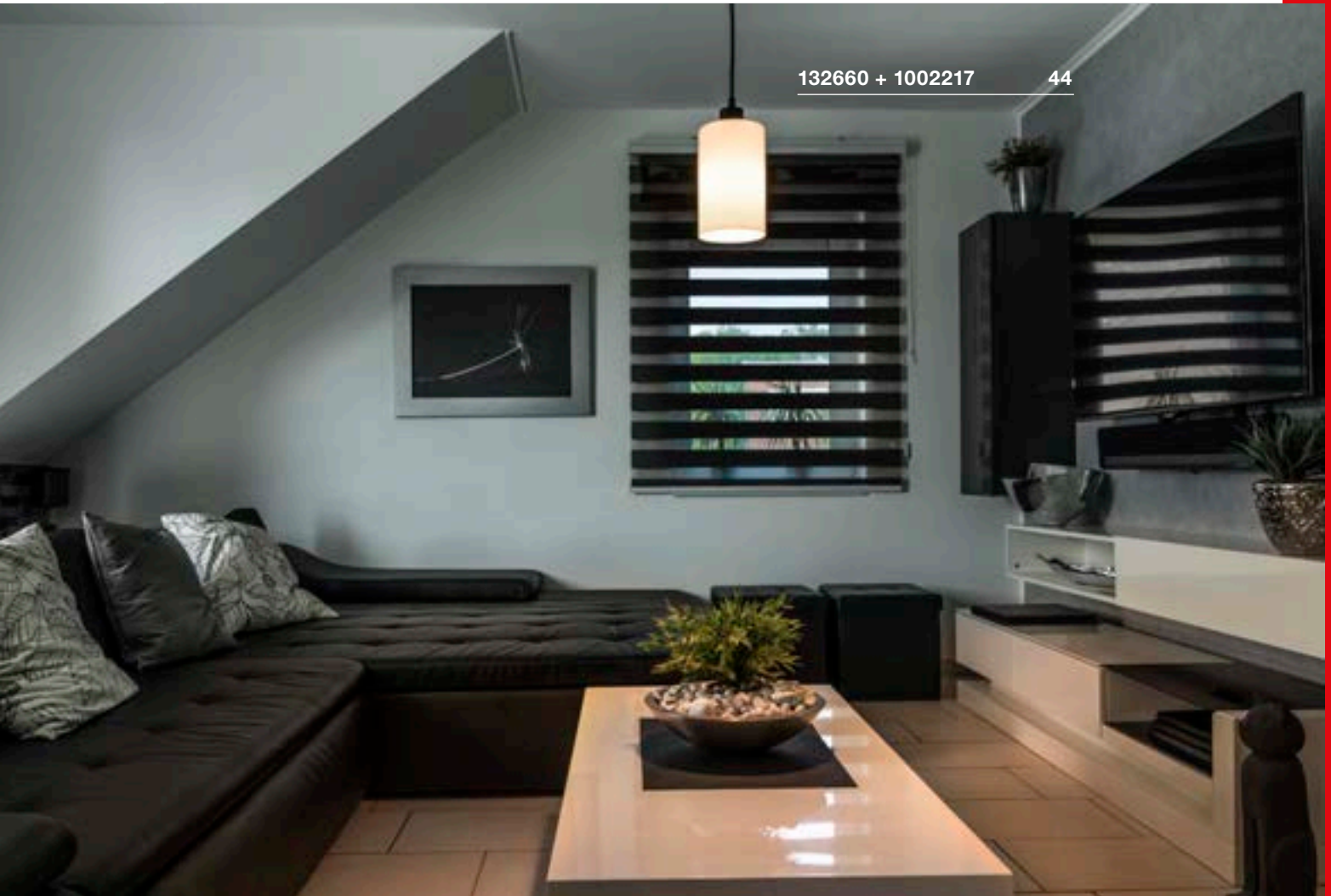

132660 + 1002217

44

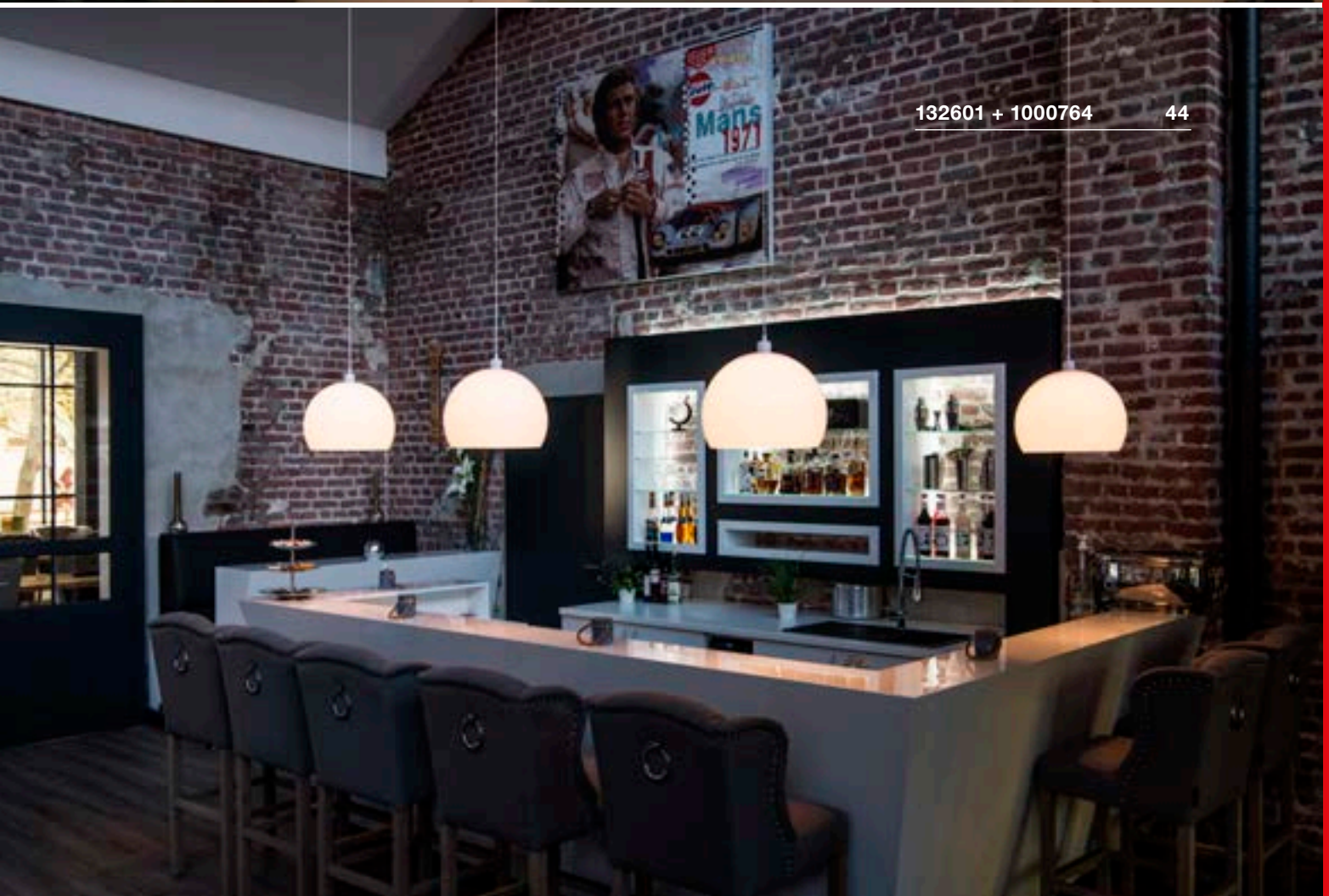

132601 + 1000764

44

FENDA
Ø 15 cm, rund



MIX & MATCH



- Durch Auswahl einer geeigneten Leuchtenbasis individuell gestaltbar

Produktangaben

Material: Textil / Stahl



Maßzeichnung

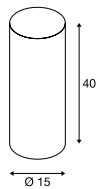

Hinweis

max. 40W



Variante	Art. Nr.
weiß	156141
beige	156143
schwarz / kupfer	156152

132605 + 156143 40 + 46

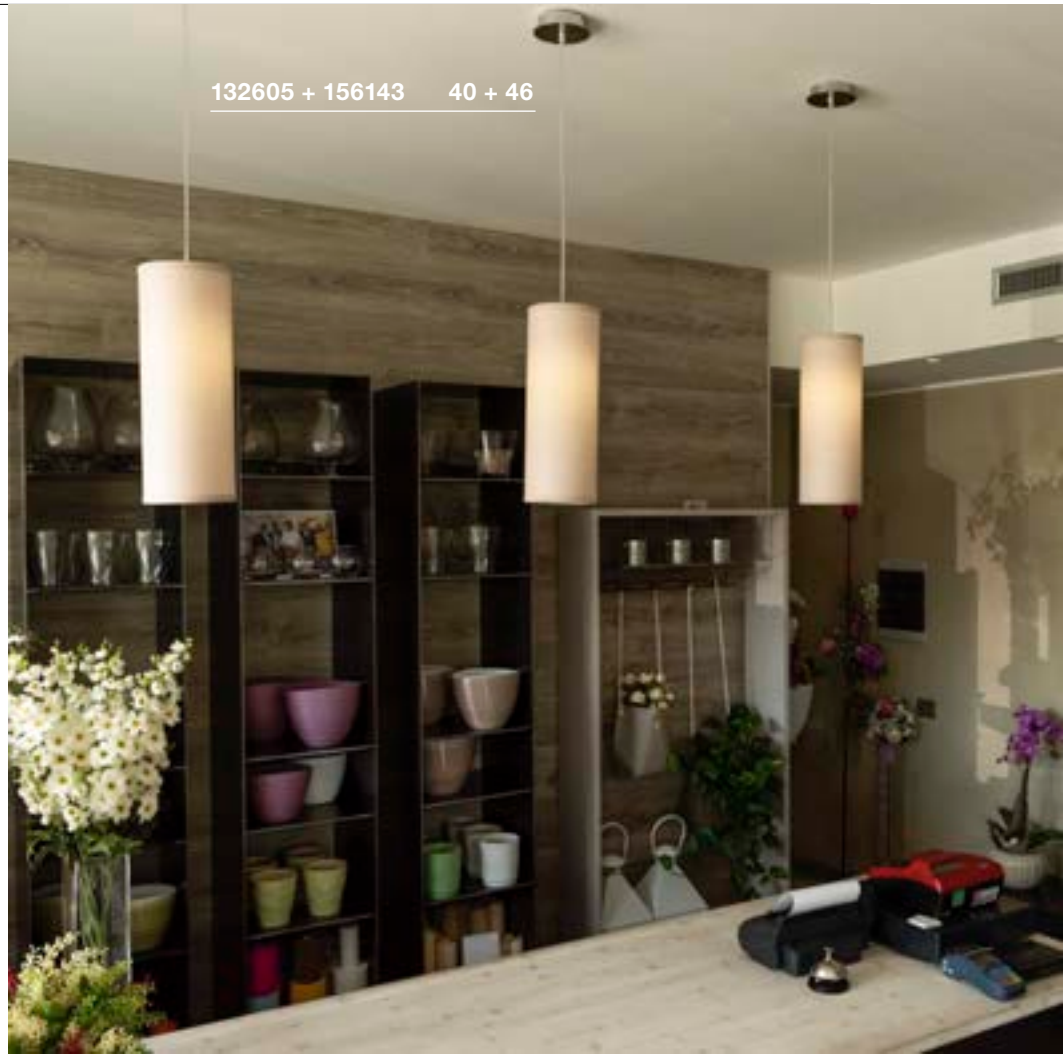

156122 47

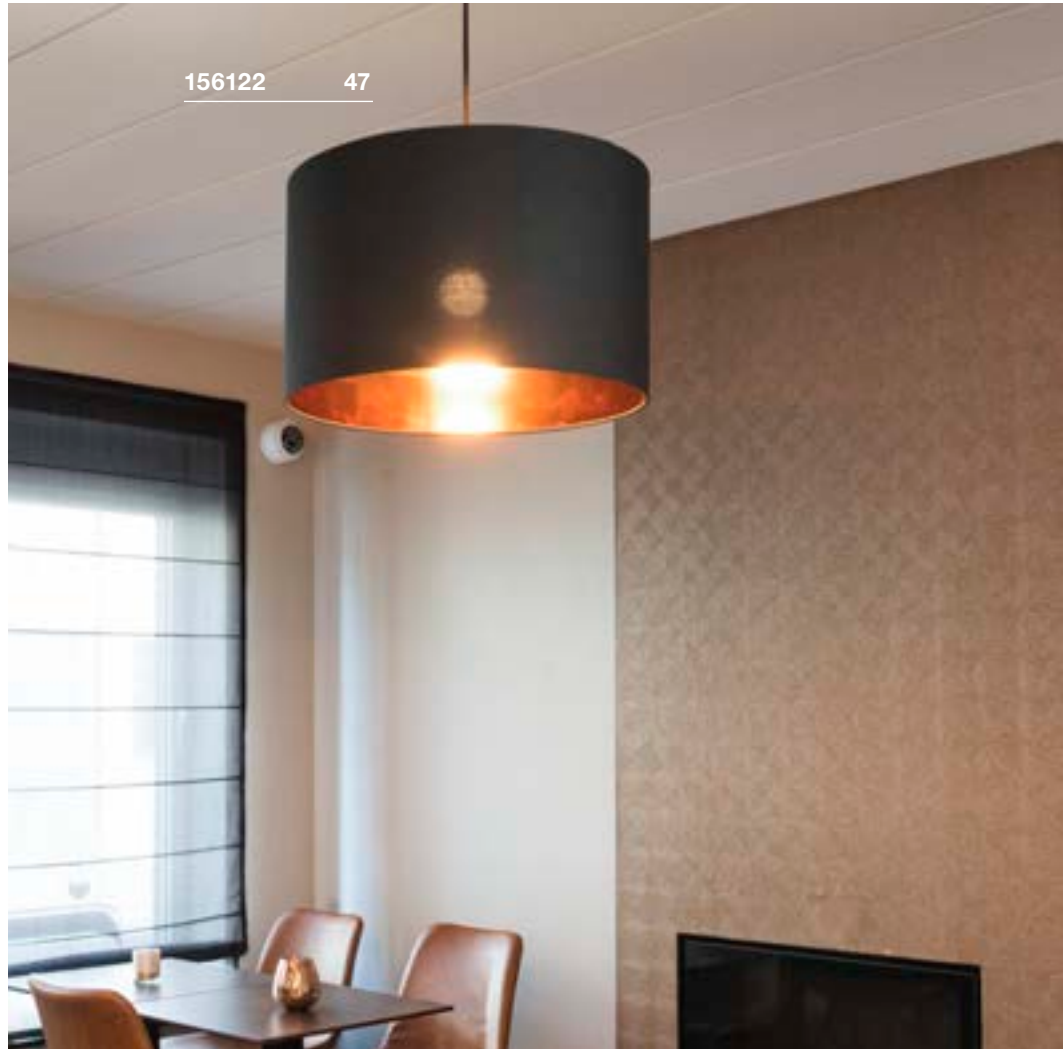

FENDA
Ø 30 cm, rund



- Durch Auswahl einer geeigneten Leuchtenbasis individuell gestaltbar

Produktangaben

Material: Textil / Stahl



Maßzeichnung

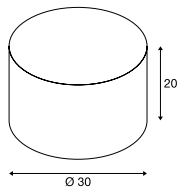

Hinweis

max. 60W
Acrylglasabdeckung (155570), um den Schirm einseitig zu schließen als Zubehör erhältlich.



Zubehörempfehlung

Acrylglasabdeckung
Art. Nr. 155570

Variante	Art. Nr.
<input type="checkbox"/> weiß	155582
<input type="checkbox"/> beige	155583
<input type="checkbox"/> schwarz / kupfer	155592

FENDA
Ø 45 cm, rund



- Durch Auswahl einer geeigneten Leuchtenbasis individuell gestaltbar

Produktangaben

Material: Textil / Stahl



Maßzeichnung

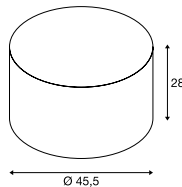

Hinweis

max. 60W
Acrylglasabdeckung (156100), um den Schirm einseitig zu schließen als Zubehör erhältlich.

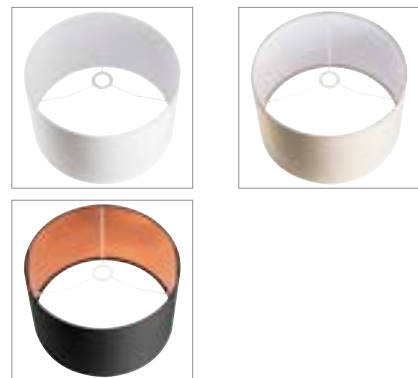

Zubehörempfehlung

Acrylglasabdeckung
Art. Nr. 156100

Variante	Art. Nr.
<input type="checkbox"/> weiß	156111
<input type="checkbox"/> beige	156113
<input type="checkbox"/> schwarz / kupfer	156122

FENDA
Ø 70 cm, rund

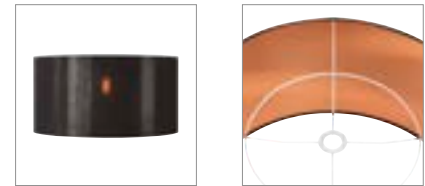

- Durch Auswahl einer geeigneten Leuchtenbasis individuell gestaltbar

Produktangaben

Material: Textil / Stahl



Maßzeichnung

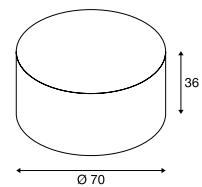

Hinweis

max. 60W
Acrylglasabdeckung (1000957), um den Schirm einseitig zu schließen als Zubehör erhältlich.

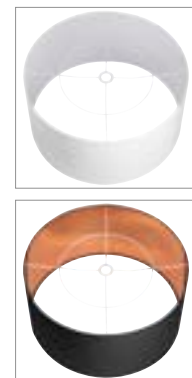

Zubehörempfehlung

Acrylglasabdeckung
Art. Nr. 1000957

Variante	Art. Nr.
<input type="checkbox"/> weiß	1000579
<input checked="" type="checkbox"/> schwarz / kupfer	1000580

PLASTRA 25
PD, cone, TCR-TSE

893

B-A++ Spektrum
A++-E

1000782 48



- Individuell gestaltbar mit Farben, Stickern & mehr

Produktangaben

230V ~50Hz
Material: Gips / Stahl

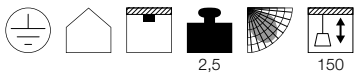

2,5

150

Maßzeichnung

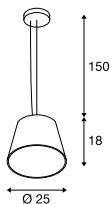

Leuchtmittlempfehlung

GX53 7,5W 120°
3000K 620lm EEK=A+
8kWh/1000h
Art. Nr. 1001220



LED GX53 4,2W 35°
3000K 200lm EEK=A
5kWh/1000h
Art. Nr. 550092



Leuchtmittelangaben

max. 11W TCR-TSE

Variante	Art. Nr.
GX53 TCR-TSE <input type="checkbox"/> weiß	1000782

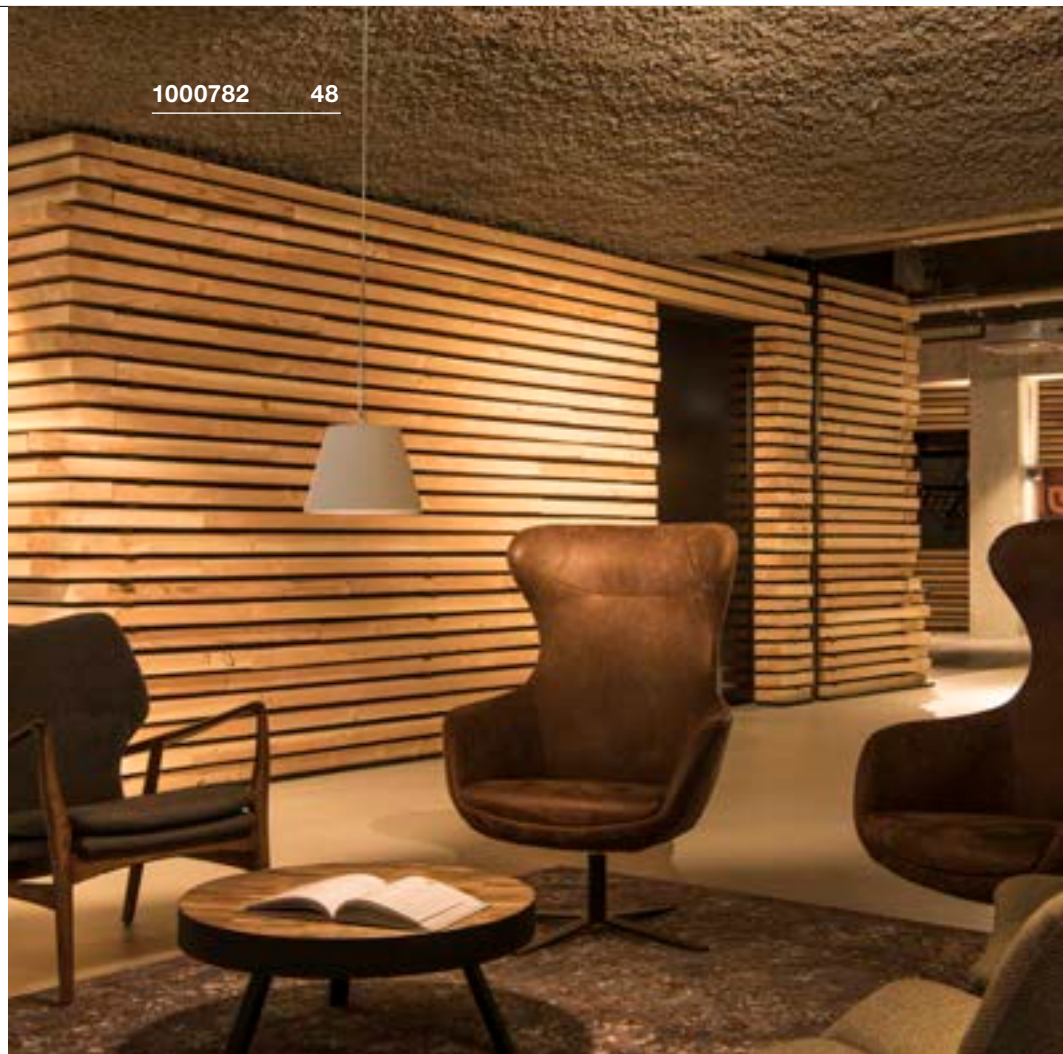

148040 49



148040 49



1002047 49

PLASTRA 25
PD, TCR-TSE



B-A++ Spektrum A++-E



- Individuell gestaltbar mit Farben, Stickern & mehr

Produktangaben

230V ~50Hz
Material: Gips / Stahl

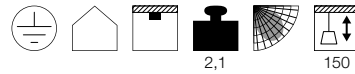

Maßzeichnung

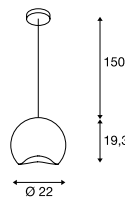

Leuchtmittlempfehlung

GX53 7,5W 120°
4000K 620lm EEK=A+
8kWh/1000h
Art. Nr. 1001221



LED GX53 7,5W 25°
3000K 450lm EEK=A
8kWh/1000h
Art. Nr. 550082



Leuchtmittelangaben

max. 11W TCR-TSE

Variante	Art. Nr.
GX53 TCR-TSE	
<input type="checkbox"/> weiß	148040

PLASTRA 25
PD, round, TCR-TSE



B-A++ Spektrum A++-E



- Individuell gestaltbar mit Farben, Stickern & mehr

Produktangaben

230V ~50Hz
Material: Gips / Stahl

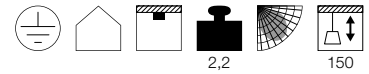

Maßzeichnung

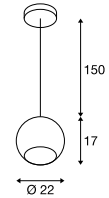

Leuchtmittlempfehlung

GX53 7,5W 120°
4000K 620lm EEK=A+
8kWh/1000h
Art. Nr. 1001221



LED GX53 7,5W 25°
3000K 450lm EEK=A
8kWh/1000h
Art. Nr. 550082



Leuchtmittelangaben

max. 11W TCR-TSE

Variante	Art. Nr.
GX53 TCR-TSE	
<input type="checkbox"/> weiß	1002047

LIGHT EYE® 90
PD, GU10



• Der Optionale Dekoring für das Leuchtmittel in der passenden Farbe verringert den Abstand zwischen Gehäuse und Leuchtmittel

Produktangaben

220-240V ~50/60Hz
Material: Stahl

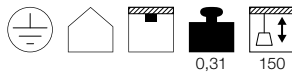

0,31 150

Maßzeichnung

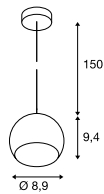

Hinweis

Textilkabel

Zubehörempfehlung

- Leuchtmittel Dekoring Ø 5,7cm
Art. Nr. 151040
- Leuchtmittel Dekoring Ø 5,7cm
Art. Nr. 151041
- Leuchtmittel Dekoring Ø 5,7cm
Art. Nr. 151049

Leuchtmittlempfehlung

GU10 5,5W 36°
2800K 420lm EEK=A+
6kWh/1000h
Art. Nr. 1001217

Leuchtmittelangaben

max. 6W LED GU10 51mm

Variante	Art. Nr.
GU10 LED GU10 51mm ■ schwarz / chrom	133490
GU10 LED GU10 51mm ■ weiß / chrom	133491
GU10 LED GU10 51mm ■ gold	133493
GU10 LED GU10 51mm ■ kupfer	133499

LIGHT EYE® 150
PD, QPAR111



Produktangaben

220-240V ~50/60Hz
Material: Stahl

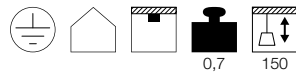

0,7 150

Maßzeichnung

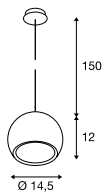

Hinweis

Textilkabel

Leuchtmittlempfehlung

GU10 15,5W 30°
2700K 680lm EEK=A
16kWh/1000h
Art. Nr. 570672

Leuchtmittelangaben

max. 75W QPAR111

Variante	Art. Nr.
GU10 QPAR111 ■ weiß / chrom	133481
GU10 QPAR111 ■ chrom	133482
GU10 QPAR111 ■ gold	133483
GU10 QPAR111 ■ kupfer	133489

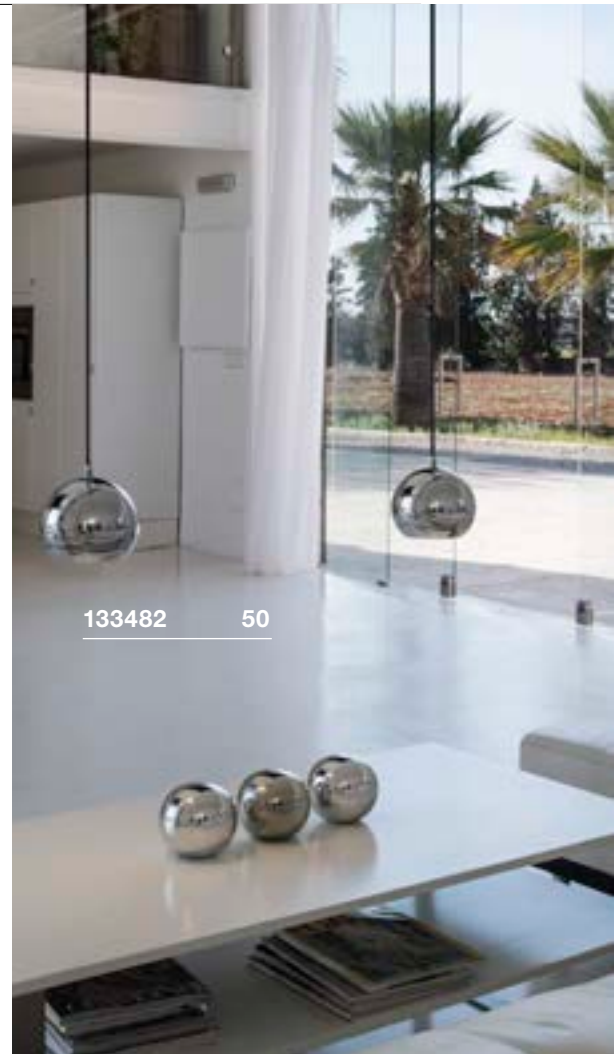



133481 50



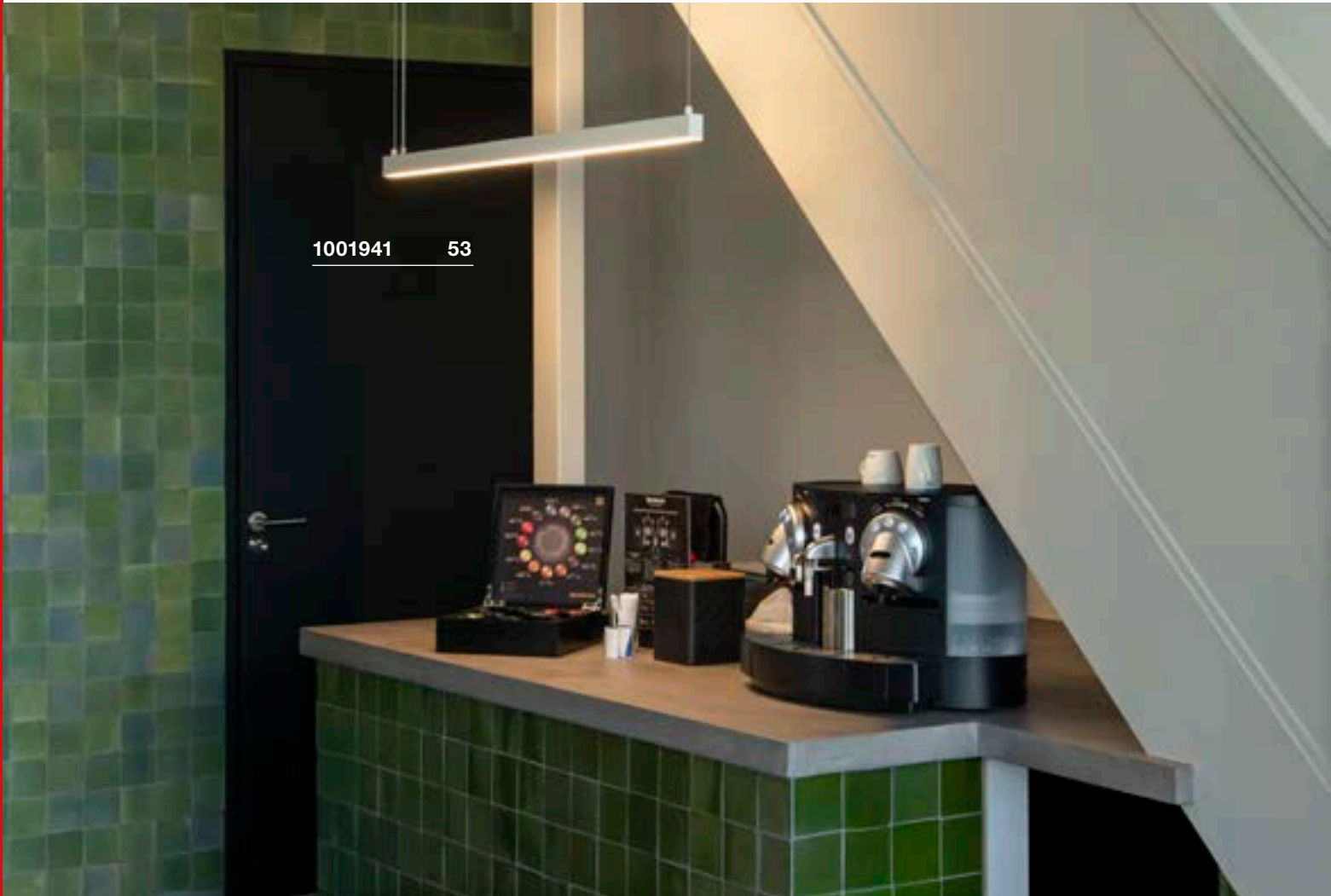

VINCELLI D
PD, TRIAC



A-A++ Spektrum A++-E

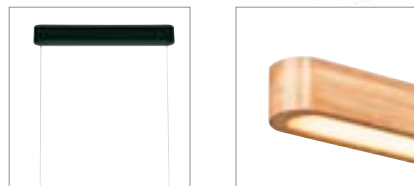

- Schlankes Design
- Leuchtenkorpus aus echtem Bambus

Produktangaben

220-240V ~50/60Hz | 700mA
Systemleistung: 29W
Material: Bambus / Stahl
Dimmbar: Triac C, Triac L

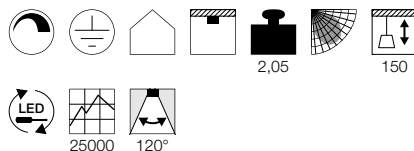

Maßzeichnung

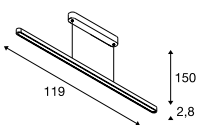

Variante	Art. Nr.
1400lm 2700K CRI>80 ■ bambus / schwarz	156268

AROSA
PD, 1,25m, TRIAC

A-A++ Spektrum A++-E



- Geradliniges Design
- Direktes und indirektes Licht

Produktangaben

220-240V ~50/60Hz | 500mA
Systemleistung: 32W
Material: Aluminium / Polymethylacrylat (PMMA)
Dimmbar: Triac C

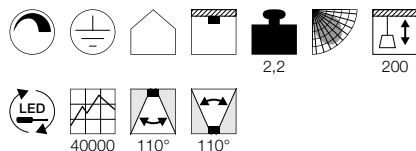

Maßzeichnung

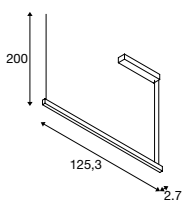

Variante	Art. Nr.
Up: 750lm 3000K CRI>80 Down: 950lm 3000K CRI>80 ■ schwarz	1001940
Up: 750lm 3000K CRI>80 Down: 950lm 3000K CRI>80 □ matt weiß	1001941
Up: 750lm 3000K CRI>80 Down: 950lm 3000K CRI>80 □ aluminium	1001942

AROSA
PD, 2m, TRIAC

A-A++ Spektrum A++-E

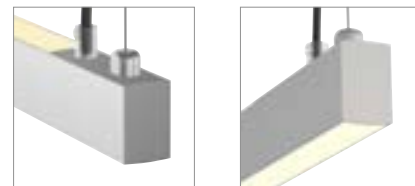
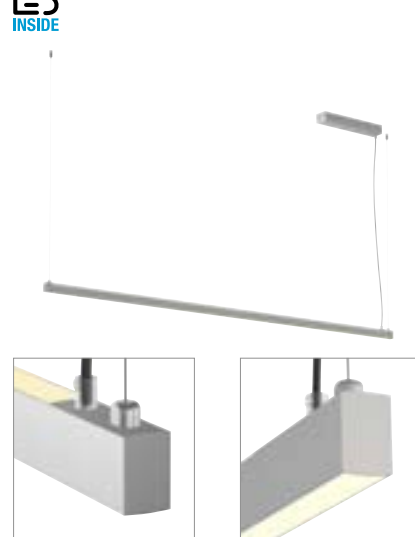

- Geradliniges Design
- Direktes und indirektes Licht

Produktangaben

220-240V ~50/60Hz | 600mA
Systemleistung: 65W
Material: Aluminium / Polymethylacrylat (PMMA)
Dimmbar: Triac C

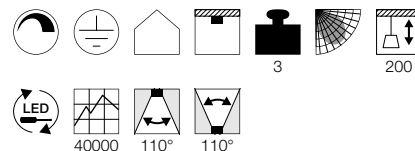

Maßzeichnung

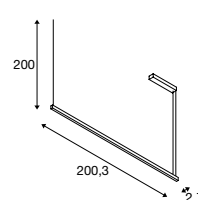

Variante	Art. Nr.
Up: 1800lm 3000K CRI>80 Down: 1800lm 3000K CRI>80 ■ schwarz	1001943
Up: 1800lm 3000K CRI>80 Down: 1800lm 3000K CRI>80 □ matt weiß	1001944
Up: 1800lm 3000K CRI>80 Down: 1800lm 3000K CRI>80 □ aluminium	1001945

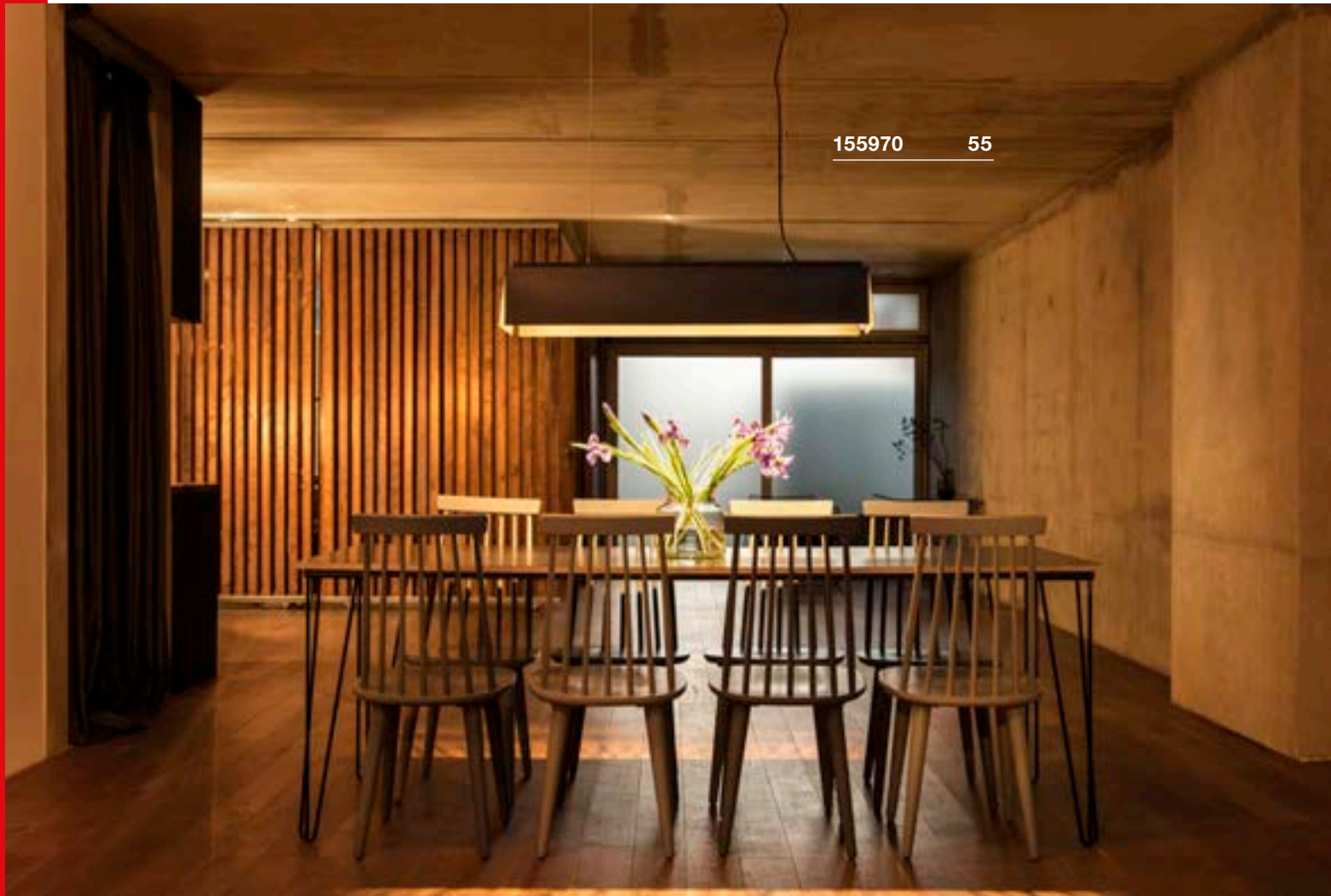

155970 55

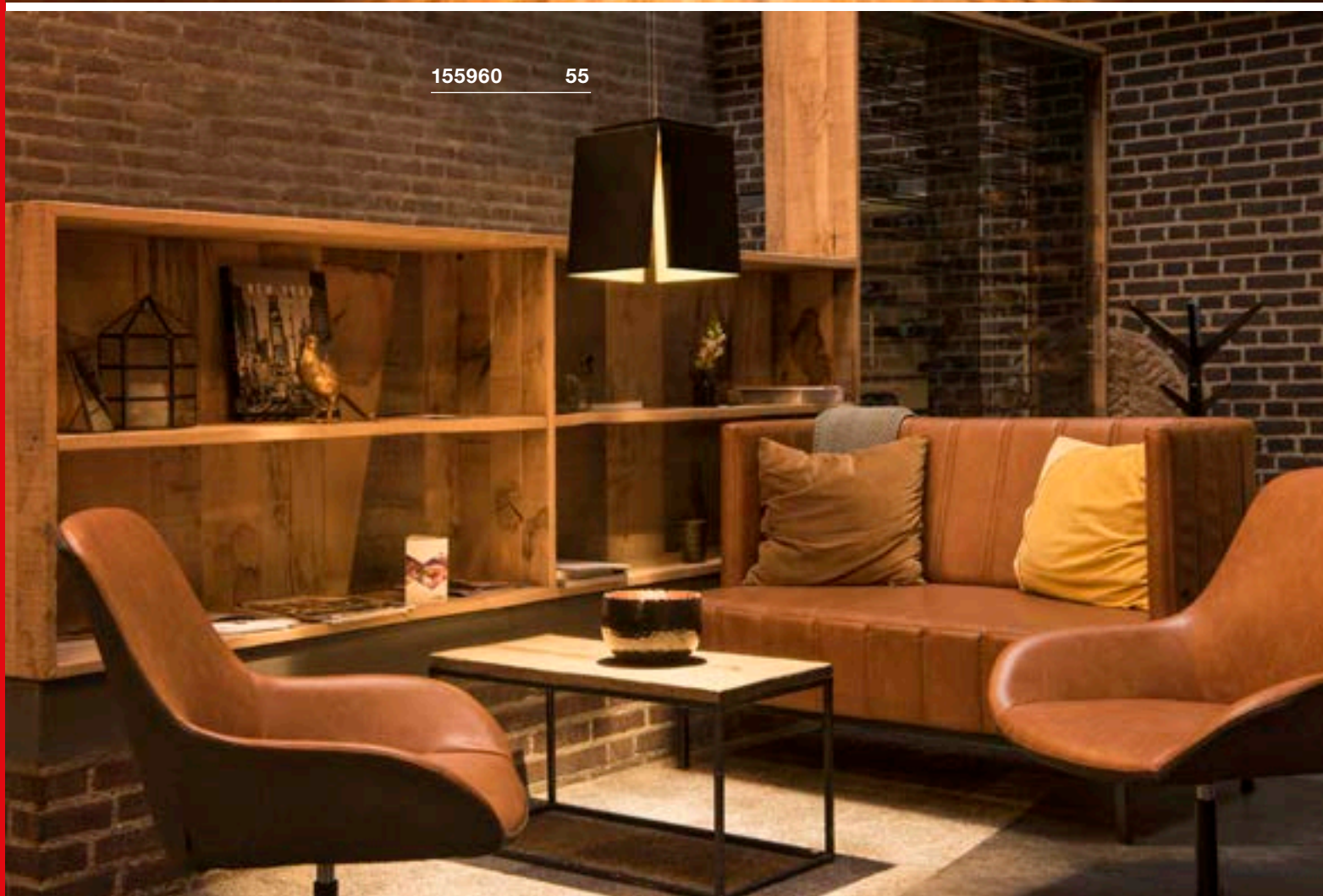

155960 55



AVENTO 30 PD

A-A++ Spektrum A++-E



- Strukturierte Innenbeschichtung in Goldfarbe

Produktangaben

220-240V ~50/60Hz | 350mA
 Systemleistung: 15W
 Material: Aluminium
 Dimmbar: Triac C

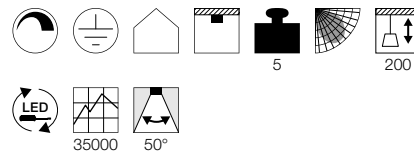

Maßzeichnung

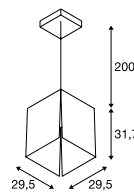

Hinweis

Textilkabel

Variante	Art. Nr.
660lm 3000K CRI>80 ■ schwarz / gold	155960

AVENTO 110 PD

A-A++ Spektrum A++-E

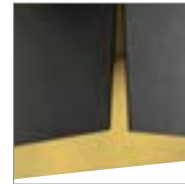

- Strukturierte Innenbeschichtung in Goldfarbe

Produktangaben

220-240V ~50/60Hz | 700mA
 Systemleistung: 29W
 Material: Aluminium
 Dimmbar: Triac C

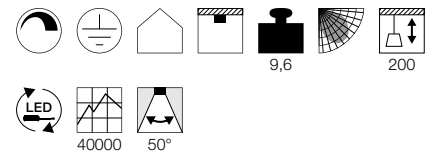

Maßzeichnung

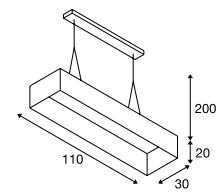

Hinweis

Textilkabel

Variante	Art. Nr.
2500lm 3000K CRI>80 ■ schwarz / gold	155970

PHELIA
PD, E27



893

A-A++ Spektrum
A++-E



- Individuelle Leuchtenkopffor
- Durch individuelle Zusammenstellung zur Leuchtenwolke kombinierbar

Produktangaben

220-240V ~50/60Hz
Material: Aluminium

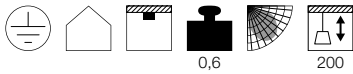

Maßzeichnung

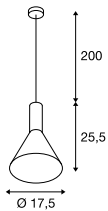

Hinweis

Textilkabel

Leuchtmittelempfehlung

LED E27 7W 280°
2200-2700K 830lm EEK=A++
7kWh/1000h
Art. Nr. 1002126



LED E27 9,1W 240°
2700K 760lm EEK=A+
10kWh/1000h
Art. Nr. 560402



Leuchtmittelangaben

max. 23W

Variante	Art. Nr.
E27 ■ schwarz / gold	1002948
E27 ■ schwarz / weiß	133300
E27 □ weiß	1002136



1002948 56

1002951 57

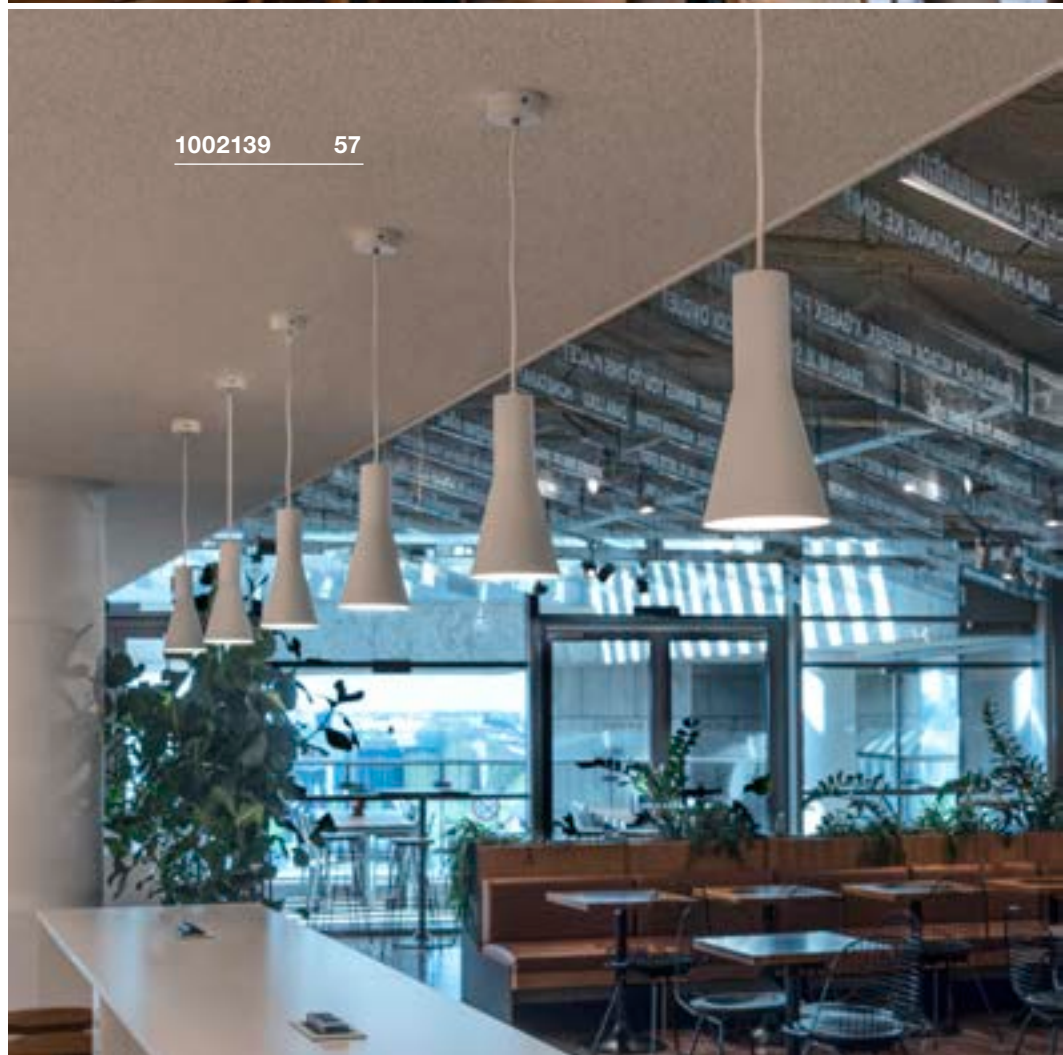

1002139 57

PHELIA
PD, E27



A-A++ Spektrum A++-E



- Individuelle Leuchtenkopffor
- Durch individuelle Zusammenstellung zur Leuchtenwolke kombinierbar

Produktangaben

220-240V ~50/60Hz
Material: Aluminium

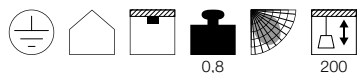

Maßzeichnung

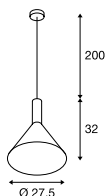

Hinweis

Textilkabel

Leuchtmittlempfehlung

LED E27 7W 280°
2200-2700K 830lm EEK=A++
7kWh/1000h
Art. Nr. 1002126



LED E27 9,1W 240°
2700K 760lm EEK=A+
10kWh/1000h
Art. Nr. 560402



Leuchtmittelangaben

max. 23W

Variante	Art. Nr.
E27 ■ schwarz / gold	1002949
E27 ■ schwarz / weiß	133310
E27 □ weiß	1002137

PHELIA
PD, E27



A-A++ Spektrum A++-E



- Individuelle Leuchtenkopffor
- Durch individuelle Zusammenstellung zur Leuchtenwolke kombinierbar

Produktangaben

220-240V ~50/60Hz
Material: Aluminium

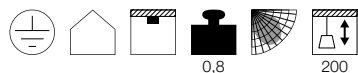

Maßzeichnung

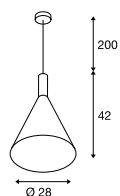

Hinweis

Textilkabel

Leuchtmittlempfehlung

LED E27 7W 280°
2200-2700K 830lm EEK=A++
7kWh/1000h
Art. Nr. 1002126



LED E27 9,1W 240°
2700K 760lm EEK=A+
10kWh/1000h
Art. Nr. 560402



Leuchtmittelangaben

max. 23W

Variante	Art. Nr.
E27 ■ schwarz / gold	1002950
E27 ■ schwarz / weiß	133320
E27 □ weiß	1002138

PHELIA
PD, E27



A-A++ Spektrum A++-E



- Individuelle Leuchtenkopffor
- Durch individuelle Zusammenstellung zur Leuchtenwolke kombinierbar

Produktangaben

220-240V ~50/60Hz
Material: Aluminium

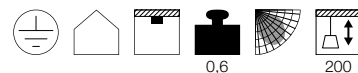

Maßzeichnung

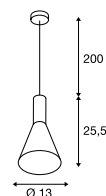

Hinweis

Textilkabel

Leuchtmittlempfehlung

LED E27 7W 280°
2200-2700K 830lm EEK=A++
7kWh/1000h
Art. Nr. 1002126



LED E27 9,1W 240°
2700K 760lm EEK=A+
10kWh/1000h
Art. Nr. 560402



Leuchtmittelangaben

max. 23W

Variante	Art. Nr.
E27 ■ schwarz / gold	1002951
E27 ■ schwarz / weiß	133330
E27 □ weiß	1002139

BATO 35
PD, TRIAC



A-A++ Spektrum
A++-E



• Durch individuelle Zusammenstellung zur Leuchtenwolke kombinierbar

Produktangaben

220-240V ~50/60Hz | 500mA
Systemleistung: 21W
Material: Aluminium / Polymethylacrylat (PMMA)
Dimmbar: Triac C

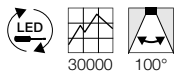
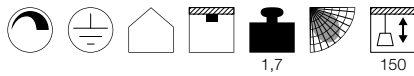

Maßzeichnung

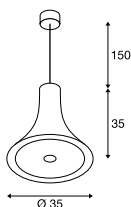

Hinweis

Textilkabel

BATO 35
PD, E27



E-A++ Spektrum
A++-E



• Durch individuelle Zusammenstellung zur Leuchtenwolke kombinierbar

Produktangaben

220-240V ~50/60Hz
Material: Aluminium / Stahl

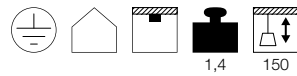

Maßzeichnung

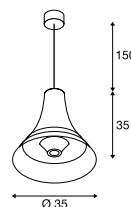

Hinweis

Textilkabel

Leuchtmittlempfehlung

LED E27 7W 280°
2700K 790lm EEK=A++
7kWh/1000h
Art. Nr. 1002124



LED E27 7W 330°
2700K 630lm EEK=A+
8kWh/1000h
Art. Nr. 1001357



Leuchtmittelangaben

max. 60W

Variante	Art. Nr.
1300lm 2700K CRI>80 ■ schwarz / matt messing	1001351
1300lm 2700K CRI>80 ■ schwarz	1000436
1500lm 2500K CRI>80 ■ matt messing	1000441

Variante	Art. Nr.
E27 ■ schwarz / matt messing	1001266
E27 ■ schwarz	1000434
E27 ■ matt messing	1000439

BATO 45
PD, TRIAC



A-A++ Spektrum
A++-E



• Durch individuelle Zusammenstellung zur Leuchtenwolke kombinierbar

Produktangaben

220-240V ~50/60Hz | 700mA
Systemleistung: 30W
Material: Aluminium / Polymethylacrylat (PMMA)
Dimmbar: Triac C

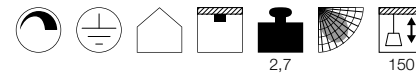

Maßzeichnung

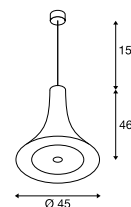

Hinweis

Textilkabel

Variante	Art. Nr.
1450lm 2700K CRI>80 ■ schwarz / matt messing	1001350
1450lm 2700K CRI>80 ■ schwarz	1000435
1900lm 2500K CRI>80 ■ matt messing	1000440

BATO 45
PD, E27E-A++ Spektrum
A++-E

- Durch individuelle Zusammenstellung zur Leuchtenwolke kombinierbar

Produktangaben

220-240V ~50/60Hz
Material: Aluminium / Stahl

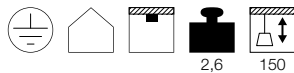

2,6

150

Maßzeichnung

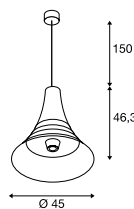

Hinweis

Textilkabel

Leuchtmittelpfehlung

LED E27 7W 280°
2700K 790lm EEK=A++
7kWh/1000h
Art. Nr. 1002124



LED E27 7W 330°
2700K 630lm EEK=A+
8kWh/1000h
Art. Nr. 1001357



Leuchtmittelangaben

max. 60W

Variante	Art. Nr.
E27	
■ schwarz / matt messing	1001265
E27	
■ schwarz	1000433
E27	
■ matt messing	1000438



1000436 58

1001266 58

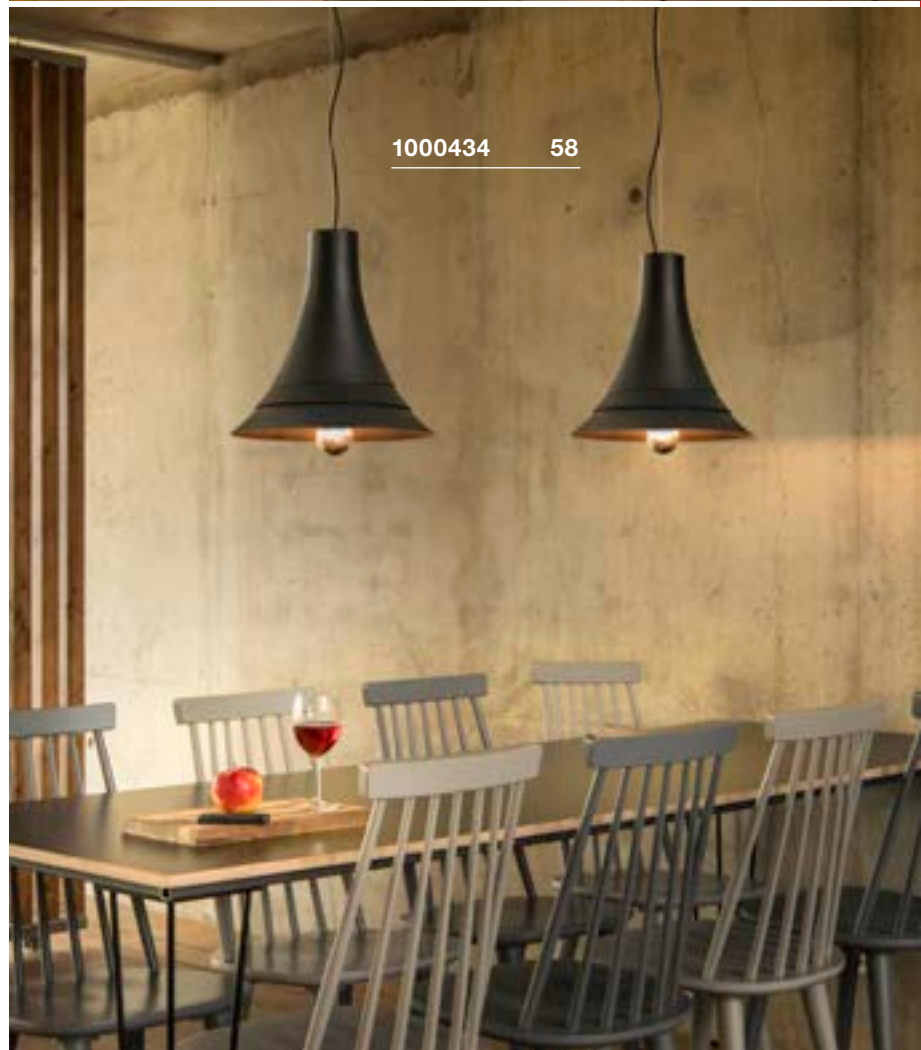

1000434 58

133897 61





143430 391

133887 61



133886 61

BELA 40 PD

A-A++ Spektrum A++-E



- Blendreduziert durch zurückliegende, diffuse euchtfläch

Produktangaben

220-240V ~50/60Hz | 700mA
Systemleistung: 24W
Material: Aluminium / Polymethylacrylat (PMMA)

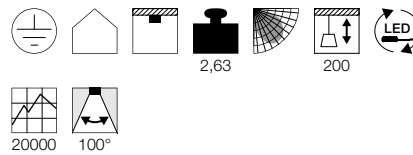

Maßzeichnung

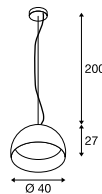

Hinweis

Textilkabel

Variante	Art. Nr.
1350lm 3000K CRI>80 □ weiß	133881
1350lm 3000K CRI>80 ■ schwarz / weiß	133886
1350lm 3000K CRI>80 ■ schwarz / gold	133887

BELA 60 PD

A-A++ Spektrum A++-E



- Blendreduziert durch zurückliegende, diffuse euchtfläch

Produktangaben

220-240V ~50/60Hz | 700mA
Systemleistung: 31W
Material: Aluminium / Polymethylacrylat (PMMA)

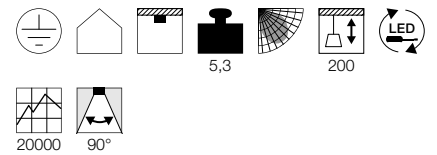

Maßzeichnung

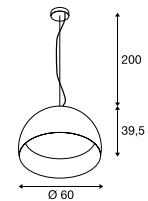

Hinweis

Textilkabel

Variante	Art. Nr.
1850lm 3000K CRI>80 □ weiß	133891
1850lm 3000K CRI>80 ■ schwarz / weiß	133896
1850lm 3000K CRI>80 ■ schwarz / gold	133897

FORCHINI 40
PD, E27



E-A++ Spektrum A++-E



- Jede Leuchte ein Unikat
- Textilkabel in Gehäusefarbe

Produktangaben

230V ~50Hz
Material: GFK

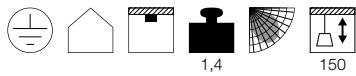

Maßzeichnung

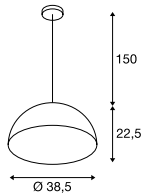

Leuchtmittlempfehlung

LED E27 7W 330°
2700K 806lm EEK=A+
8kWh/1000h
Art. Nr. 1001035



Leuchtmittelangaben

max. 40W
L: 14 cm max.

Variante	Art. Nr.
E27	
■ schwarz / grau	155500
E27	
■ schwarz / gold	155510
E27	
■ weiß / gold	155511

FORCHINI 50
PD, E27



E-A++ Spektrum A++-E



- Jede Leuchte ein Unikat
- Textilkabel in Gehäusefarbe

Produktangaben

230V ~50Hz
Material: GFK

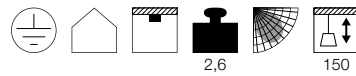

Maßzeichnung

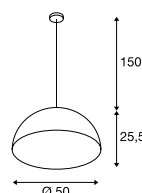

Leuchtmittlempfehlung

LED E27 7W 330°
2700K 806lm EEK=A+
8kWh/1000h
Art. Nr. 1001035



LED E27 7W 280°
2200-2700K 830lm EEK=A++
7kWh/1000h
Art. Nr. 1002126



Leuchtmittelangaben

max. 40W
L: 20 cm max.

Variante	Art. Nr.
E27	
■ schwarz / grau	155520
E27	
■ schwarz / gold	155530
E27	
■ weiß / gold	155531

FORCHINI 70
PD, E27



E-A++ Spektrum A++-E



- Jede Leuchte ein Unikat
- Textilkabel in Gehäusefarbe

Produktangaben

220-240V ~50/60Hz
Material: GFK

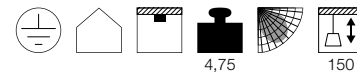

Maßzeichnung

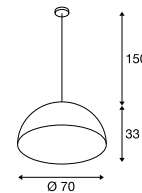

Leuchtmittlempfehlung

LED E27 7W 330°
2700K 806lm EEK=A+
8kWh/1000h
Art. Nr. 1001035



LED E27 7W 330°
2700K 806lm EEK=A+
8kWh/1000h
Art. Nr. 1001038



Leuchtmittelangaben

max. 40W
L: 20 cm max.

Variante	Art. Nr.
E27	
■ schwarz / gold	1001701

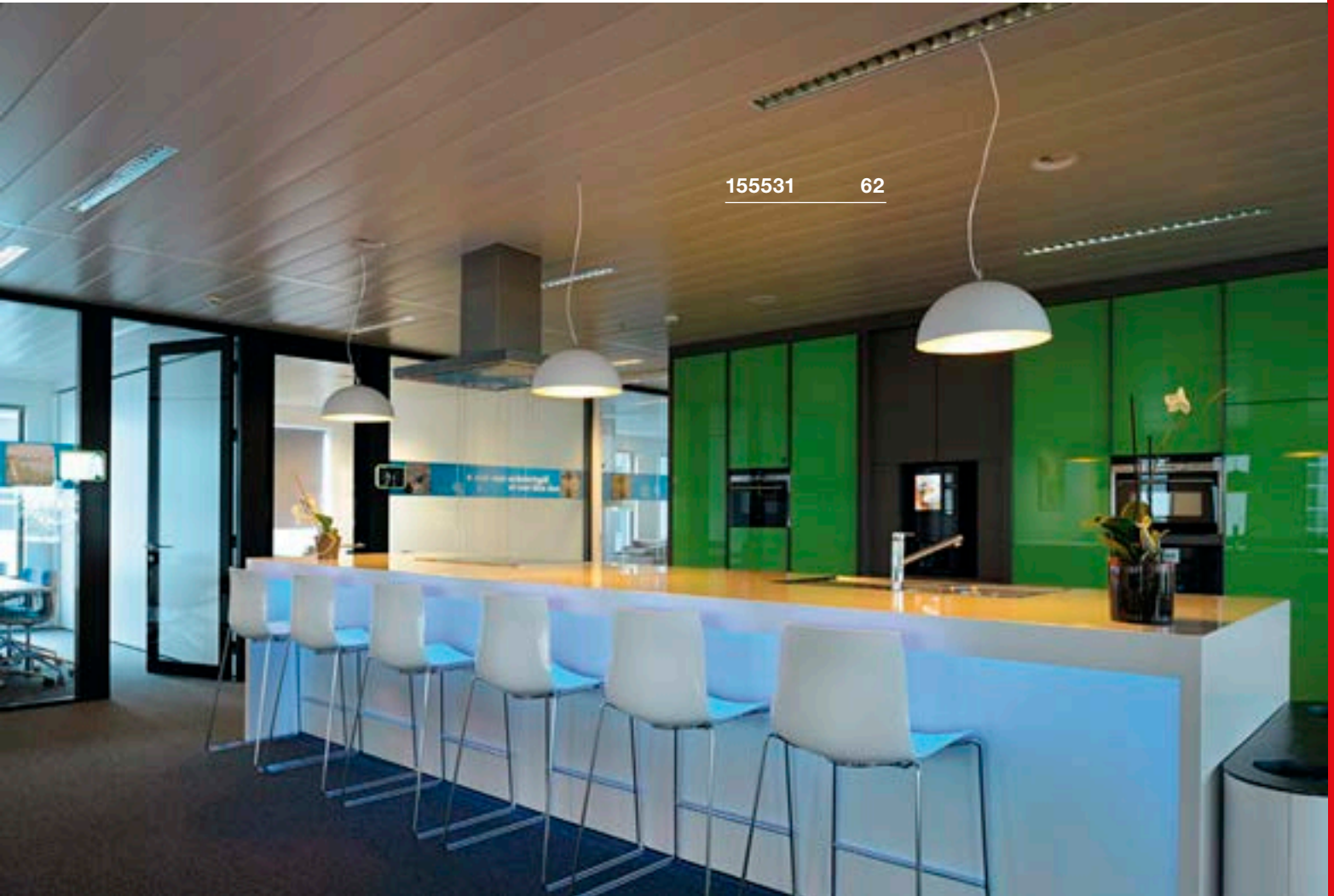

1555930 65





155910 65



155901 65

FORCHINI M 40
PD, E27



E-A++ Spektrum A++-E



- Doppelwandige Konstruktion mit innenliegendem Reflekt or
- Textilkabel in Gehäusefarbe

Produktangaben

230V ~50Hz
Material: Aluminium / Stahl

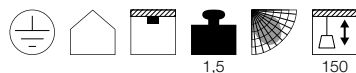

Maßzeichnung

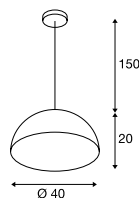

Leuchtmittlempfehlung

LED E27 7W 330°
2700K 806lm EEK=A+
8kWh/1000h
Art. Nr. 1001035



LED E27 7W 280°
2200-2700K 830lm EEK=A++
7kWh/1000h
Art. Nr. 1002126



Leuchtmittelangaben

max. 40W
L: 15,2 cm max.

Variante	Art. Nr.
E27	
■ schwarz / grau	155900
E27	
■ weiß / grau	155901
E27	
■ schwarz / gold	155910
E27	
■ weiß / gold	155911

FORCHINI M 50
PD, E27



E-A++ Spektrum A++-E



- Doppelwandige Konstruktion mit innenliegendem Reflekt or
- Textilkabel in Gehäusefarbe

Produktangaben

230V ~50Hz
Material: Aluminium / Stahl

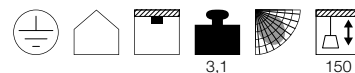

Maßzeichnung

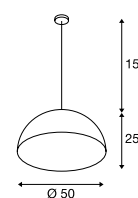

Leuchtmittlempfehlung

LED E27 7W 330°
2700K 806lm EEK=A+
8kWh/1000h
Art. Nr. 1001038



LED E27 7W 280°
2200-2700K 830lm EEK=A++
7kWh/1000h
Art. Nr. 1002126



Leuchtmittelangaben

max. 40W
L: 18 cm max.

Variante	Art. Nr.
E27	
■ schwarz / grau	155920
E27	
■ weiß / grau	155921
E27	
■ schwarz / gold	155930
E27	
■ weiß / gold	155931

PARA CONE 20
PD, E27

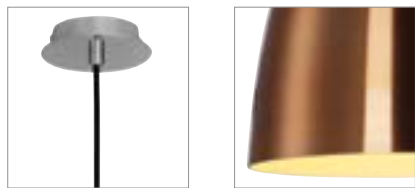

- Durch individuelle Zusammenstellung zur Leuchtenwolke kombinierbar
- Vielfältige Farb- und Größenauswahl

Produktangaben

220-240V ~50/60Hz
Material: Aluminium / Stahl

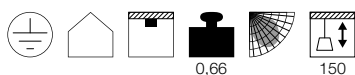

Maßzeichnung

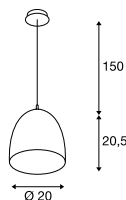

Hinweis

Textilkabel
schwarz/gold Version mit goldenem Reflekt or

Leuchtmittelempfehlung

LED E27 7W 280°
2700K 790lm EEK=A++
7kWh/1000h
Art. Nr. 1002124



Leuchtmittelangaben

max. 60W

Variante	Art. Nr.
E27 □ weiß	133001
E27 □ matt aluminium	133005
E27 ■ kupfer	133009
E27 ■ schwarz / gold	133050

PARA CONE 30
PD, E27

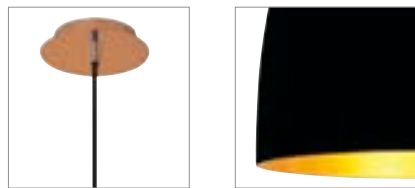

- Durch individuelle Zusammenstellung zur Leuchtenwolke kombinierbar
- Vielfältige Farb- und Größenauswahl

Produktangaben

220-240V ~50/60Hz
Material: Aluminium / Stahl

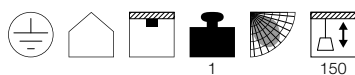

Maßzeichnung

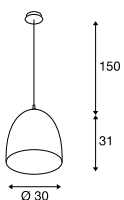

Hinweis

Textilkabel
schwarz/gold Version mit goldenem Reflekt or

Leuchtmittelempfehlung

LED E27 4,8W 330°
2700K 470lm EEK=A++
5kWh/1000h
Art. Nr. 560752



LED E27 9W 240°
2700-6500K 806lm EEK=A+
9kWh/1000h
Art. Nr. 1001916



Leuchtmittelangaben

max. 60W

Variante	Art. Nr.
E27 □ weiß	133011
E27 □ matt aluminium	133015
E27 ■ kupfer	133019
E27 ■ schwarz / gold	133060

PARA CONE 40
PD, E27



- Durch individuelle Zusammenstellung zur Leuchtenwolke kombinierbar
- Vielfältige Farb- und Größenauswahl

Produktangaben

220-240V ~50/60Hz
Material: Aluminium / Stahl

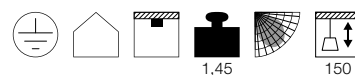

Maßzeichnung

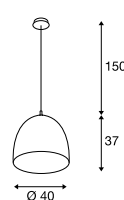

Hinweis

Textilkabel
schwarz/gold Version mit goldenem Reflekt or

Leuchtmittelempfehlung

LED E27 7W 330°
2700K 806lm EEK=A+
8kWh/1000h
Art. Nr. 1001038



LED E27 7W 330°
2700K 630lm EEK=A+
8kWh/1000h
Art. Nr. 1001357



Leuchtmittelangaben

max. 60W

Variante	Art. Nr.
E27 □ weiß	155471
E27 □ matt aluminium	155475
E27 ■ kupfer	155479
E27 ■ schwarz / gold	133070

MALANG
CW, SLV VALETO®



- Integrierbar in das SLV VALETO® System und andere ZigBee® Systeme
- Panel separat steuerbar von warm- bis kaltweiß und dimmbar
- Ring separat steuerbar in RGBW-Farben und dimmbar

Produktangaben

100-240V ~50/60Hz | 24V DC
Systemleistung: 39W
Material: Aluminium / Polycarbonat (PC)

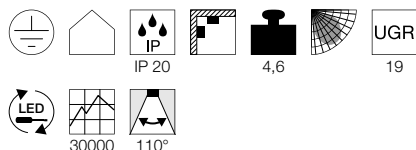

Maßzeichnung

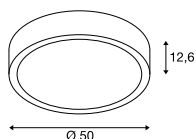

Hinweis

Fernsteuerbar und dimmbar mit SLV VALETO® CCT/RGBW Fernbedienung [1002994] oder Gateway [1002411]

Zubehöreffempfung

- Abhängeset 1,5m
Art. Nr. 135250
- Abhängeset 1,5m
Art. Nr. 135251
- Abhängeset 1,5m
Art. Nr. 135254
- Abhängeset 5m
Art. Nr. 1001950
- Abhängeset 5m
Art. Nr. 1001951
- Abhängeset 5m
Art. Nr. 1001952
- Fernbedienung CCT/RGBW
Art. Nr. 1002994

Variante	Art. Nr.
Ring: 350lm RGB+W (3000K) CRI>80 Panel: 2100-2400lm 2700-6500K CRI>80 □ weiß	1002858



Der dekorative **RING** ist separat steuerbar. Schaffen Sie ein stimmungsvolle Ambiente, indem Sie verschiedene Lichtfarben einstellen und das Licht dimmen.

Das **PANEL** ist separat steuerbar. Sie können die Farbtemperatur von 2700-6500K einstellen und das Licht dimmen.

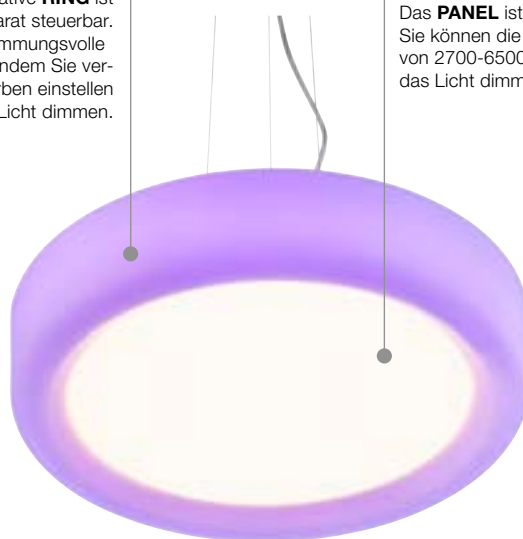

Mit unserem SLV VALETO® SMART LIGHT SYSTEM haben Sie die Wahl: Steuern Sie das Licht Zuhause mit unserer SLV VALETO® Fernbedienung (1002994), oder einer App auf Ihrem Smartphone über unser SLV VALETO® Gateway (1002411).

Dank des neuesten ZigBee Standards (ZigBee® 3.0) sind Ihnen bei Ihrer smarten Lichtsteuerung keine Grenzen gesetzt.



Fernbedienung
Art. Nr. 1002994



Gateway
Art. Nr. 1002411



SLV VALETO®
App

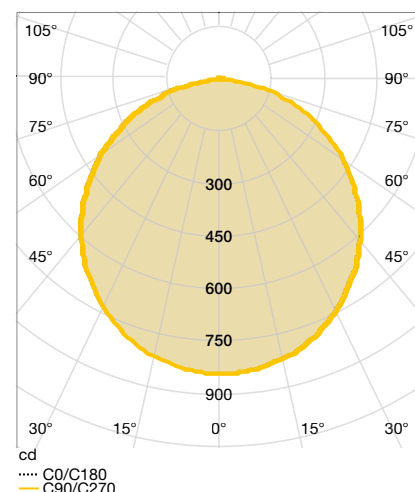
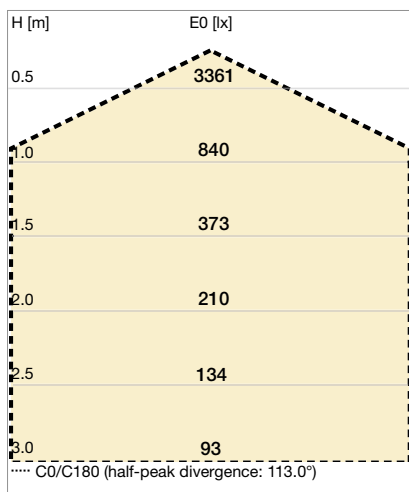

SPHERA 45
PD, TRIAC

A-A++ Spektrum A++-E

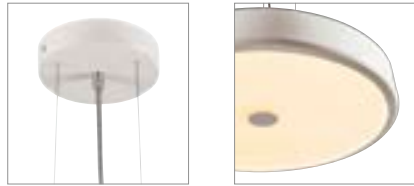

- Schlanker Leuchtenkörper
- Oberfläche hochglanzlackie t

Produktangaben

220-240V ~50/60Hz | 350mA
Systemleistung: 13W
Material: Aluminium / Acryl
Dimmbar: Triac C

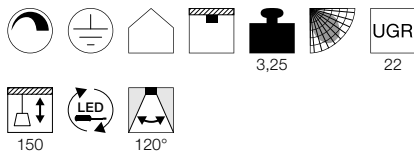

Maßzeichnung

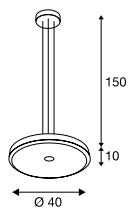

SPHERA 75
PD, TRIAC

A-A++ Spektrum A++-E

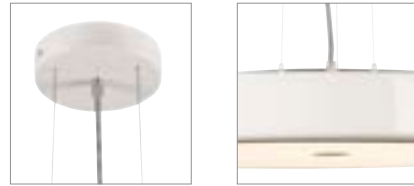

- Schlanker Leuchtenkörper
- Oberfläche hochglanzlackie t

Produktangaben

220-240V ~50/60Hz | 500mA
Systemleistung: 15W
Material: Aluminium / Acryl
Dimmbar: Triac C

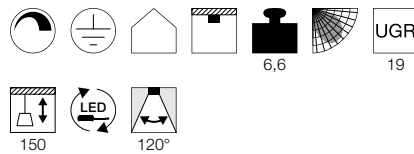

Maßzeichnung

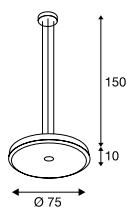

133341 68

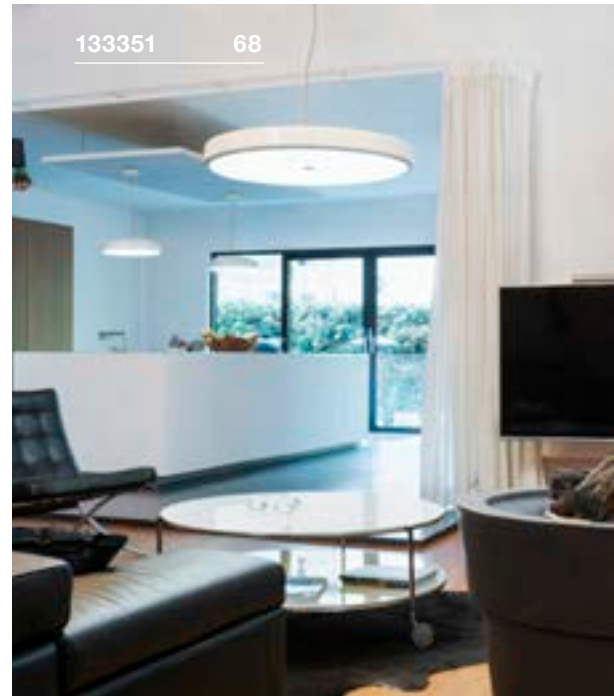

133351 68

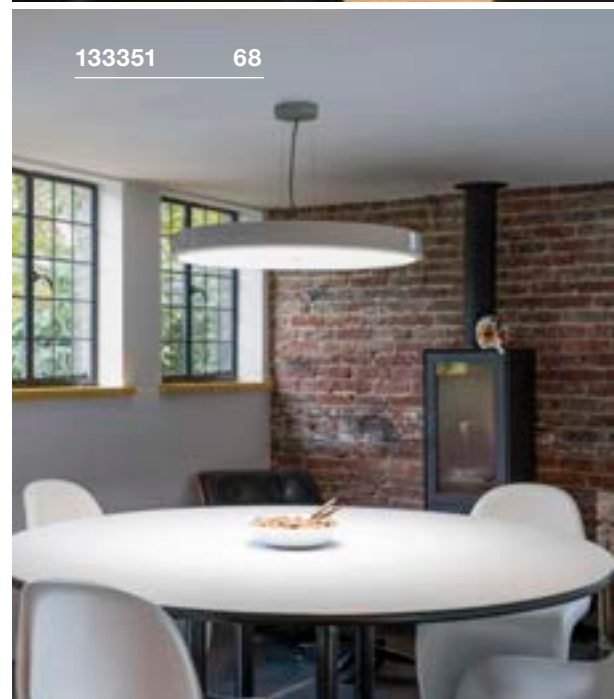

133351 68

Variante	Art. Nr.
800lm 2700K CRI>80 □ weiß	133341

Variante	Art. Nr.
1200lm 2700K CRI>80 □ weiß	133351



1002937 69

ASTINA
PD, QPAR51 884A-A++ Spektrum
A++-E

NEW



- Hochwertiges, satiniertes Glas
- 2,5 m langes Kabel

Produktangaben

220-240V ~50/60Hz
Material: Aluminium
Produktmaße: Ø: 7 cm L: 20 cm

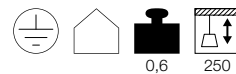



Hinweis

Offenes Kabelend
Kombinierbar mit dem Zubehör Fitu Mix & Match
auf Seite 40

Leuchtmittelangaben

GU10 QPAR51 max. 10W

Variante	Art. Nr.
GU10 QPAR51 □ matt weiß	1002937 
GU10 QPAR51 ■ matt grau	1002938 
GU10 QPAR51 ■ matt schwarz	1002939 

PLASTRA
PD, QPAR51



A-A++ Spektrum A++-E



- Individuell gestaltbar mit Farben, Stickern & mehr

Produktangaben

230V ~50Hz
Material: Gips / Stahl

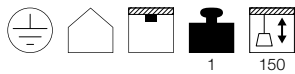

Maßzeichnung

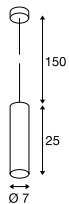

Leuchtmittlempfehlung

GU10 5,5W 36°
2800K 420lm EEK=A+
6kWh/1000h
Art. Nr. 1001217



LED GU10 7W 25/40/55°
3000K 300lm EEK=A
7kWh/1000h
Art. Nr. 560603



Leuchtmittelangaben

max. 7W QPAR51

Variante	Art. Nr.
GU10 QPAR51 □ weiß	148042

ENOLA B
PD, QPAR51



E-A++ Spektrum A++-E



Produktangaben

220-240V ~50/60Hz
Material: Aluminium / Stahl

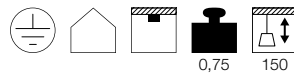

Maßzeichnung

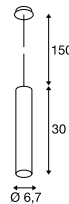

Leuchtmittlempfehlung

GU10 5,5W 36°
2800K 420lm EEK=A+
6kWh/1000h
Art. Nr. 1001217



LED GU10 7W 25/40/55°
3000K 300lm EEK=A
7kWh/1000h
Art. Nr. 560603



Leuchtmittelangaben

max. 50W QPAR51

Variante	Art. Nr.
GU10 QPAR51 ■ schwarz	151850
GU10 QPAR51 □ weiß	151851
GU10 QPAR51 ■ gold	151853
GU10 QPAR51 ■ grau / schwarz	151854

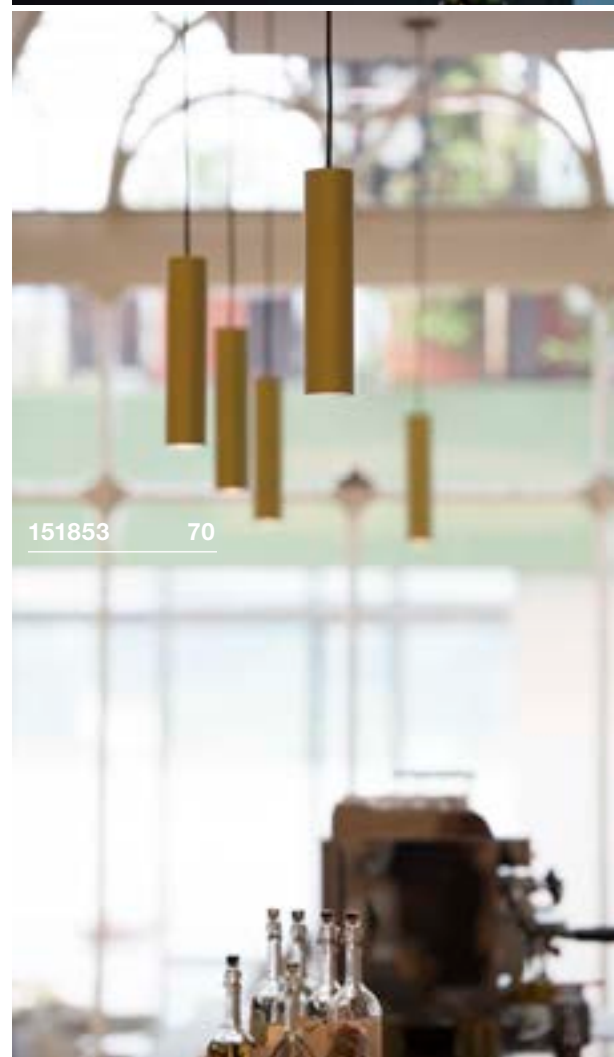



149387 71

ENOLA
PD, E27

885

E-A++ Spektrum
A++-E

Produktangaben

220-240V ~50/60Hz
Material: Aluminium / Stahl

0,98

150

Maßzeichnung

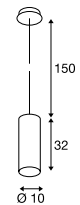

Leuchtmittelempfehlung

LED E27 9,1W 240°
2700K 760lm EEK=A+
10kWh/1000h
Art. Nr. 560402LED E27 7W 280°
2700K 790lm EEK=A++
7kWh/1000h
Art. Nr. 1002124

Leuchtmittelangaben

max. 60W
Ø: 9 cm max. L: 18 cm max.

Variante	Art. Nr.
E27	
■ matt schwarz	149388
E27	
□ weiß	149381
E27	
■ matt aluminium	149385
E27	
■ gold	149387

HELIA 30 PD



A-A++ Spektrum A++-E



- Premium LED mit CRI>90
- Schlanker, extra langer Leuchtenkörper
- Rosette zum Deckeneinbau

Produktangaben

500mA
Systemleistung: 7,5W
Material: Aluminium
Einbaumaße: Einbau-Ø: 6,8 cm T: 3 cm

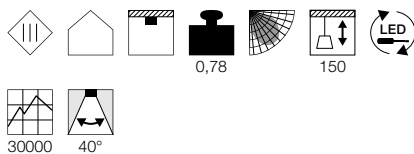

Maßzeichnung

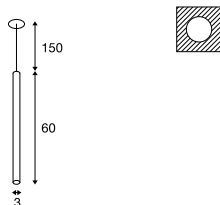

Hinweis

LED Treiber exkl.
Materialstärke Einbaufäche: max. 12 m

Zubehörempfehlung

- LED Treiber 500mA | 9W
Art. Nr. 464091
- LED Treiber 500mA | 15W dimmbar
Art. Nr. 464144

Variante	Art. Nr.
500lm 3000K CRI>90	
■ schwarz	158400
550lm 3000K CRI>90	
□ weiß	158401
550lm 3000K CRI>90	
■ gold	1002170

HELIA 40 PD



A-A++ Spektrum A++-E

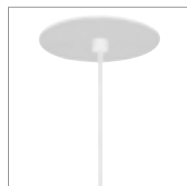

- Premium LED mit CRI>90
- Langer Leuchtenkörper
- Rosette zum Deckeneinbau

Produktangaben

500mA
Systemleistung: 9W
Material: Aluminium
Einbaumaße: Einbau-Ø: 6,8 cm T: 3 cm

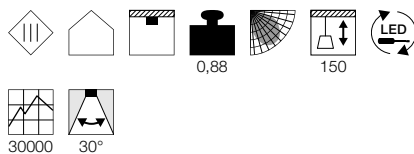

Maßzeichnung

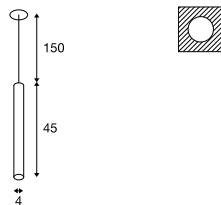

Hinweis

LED Treiber exkl.
Materialstärke Einbaufäche: max. 12 m

Zubehörempfehlung

- LED Treiber 500mA | 9W
Art. Nr. 464091
- LED Treiber 500mA | 15W dimmbar
Art. Nr. 464144

Variante	Art. Nr.
700lm 3000K CRI>90	
■ schwarz	158410
720lm 3000K CRI>90	
□ weiß	158411
720lm 3000K CRI>90	
■ gold	1002169



152360 73



1002170 73



HELIA 40

Ø: 4 cm | L: 45 cm

HELIA 30

Ø: 3 cm | L: 60 cm

HELIA 30
PD, TRIAC



A-A++ Spektrum A++-E



- Premium LED mit CRI>90

Produktangaben

220-240V ~50/60Hz | 500mA
Systemleistung: 10W
Material: Aluminium
Dimmbar: Triac C, Triac L

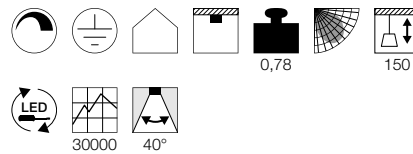

Maßzeichnung

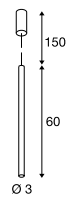

HELIA 40
PD, TRIAC



A-A++ Spektrum A++-E



- Premium LED mit CRI>90

Produktangaben

220-240V ~50/60Hz | 500mA
Systemleistung: 12W
Material: Aluminium
Dimmbar: Triac C, Triac L

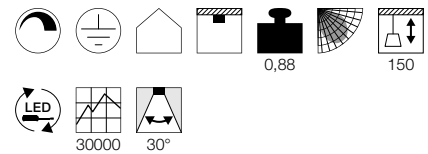

Maßzeichnung

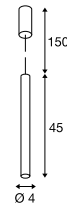

Variante	Art. Nr.
500lm 3000K CRI>90	
■ schwarz	152360
550lm 3000K CRI>90	
□ weiß	152361
550lm 3000K CRI>90	
■ gold	1002172

Variante	Art. Nr.
700lm 3000K CRI>90	
■ schwarz	152370
720lm 3000K CRI>90	
□ weiß	152371
720lm 3000K CRI>90	
■ gold	1002171

ANELA
PD, TRIAC



A-A++ Spektrum
A++-E

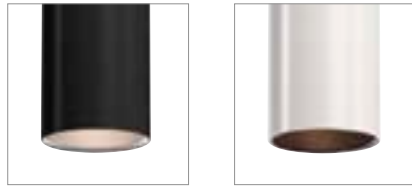

- Premium LED mit CRI>90
- Blendreduzierung
- Farbige Reflektoren als Zubehör erhältlich

Produktangaben

220-240V ~50/60Hz | 500mA
Systemleistung: 11W
Material: Aluminium
Dimmbar: Triac C

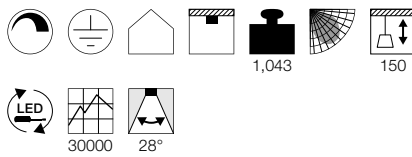

Maßzeichnung

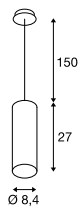

Hinweis

Reflekt or exkl.
Lichtstrom mit Reflekt or 1000809 = 500lm
Lichtstrom mit Reflekt or 1000810 = 620lm
Lichtstrom mit Reflekt or 1000811 = 200lm
Lichtstrom mit Reflekt or 1000812 = 600lm

Zubehöreffempfehlung

- Reflekt or 28°
Art. Nr. 1000809
- Reflekt or 28°
Art. Nr. 1000810
- Reflekt or 28°
Art. Nr. 1000811
- Reflekt or 28°
Art. Nr. 1000812

Variante	Art. Nr.
200-620lm 3000K CRI>90	
■ schwarz	1000813
200-620lm 3000K CRI>90	
□ weiß	1000814

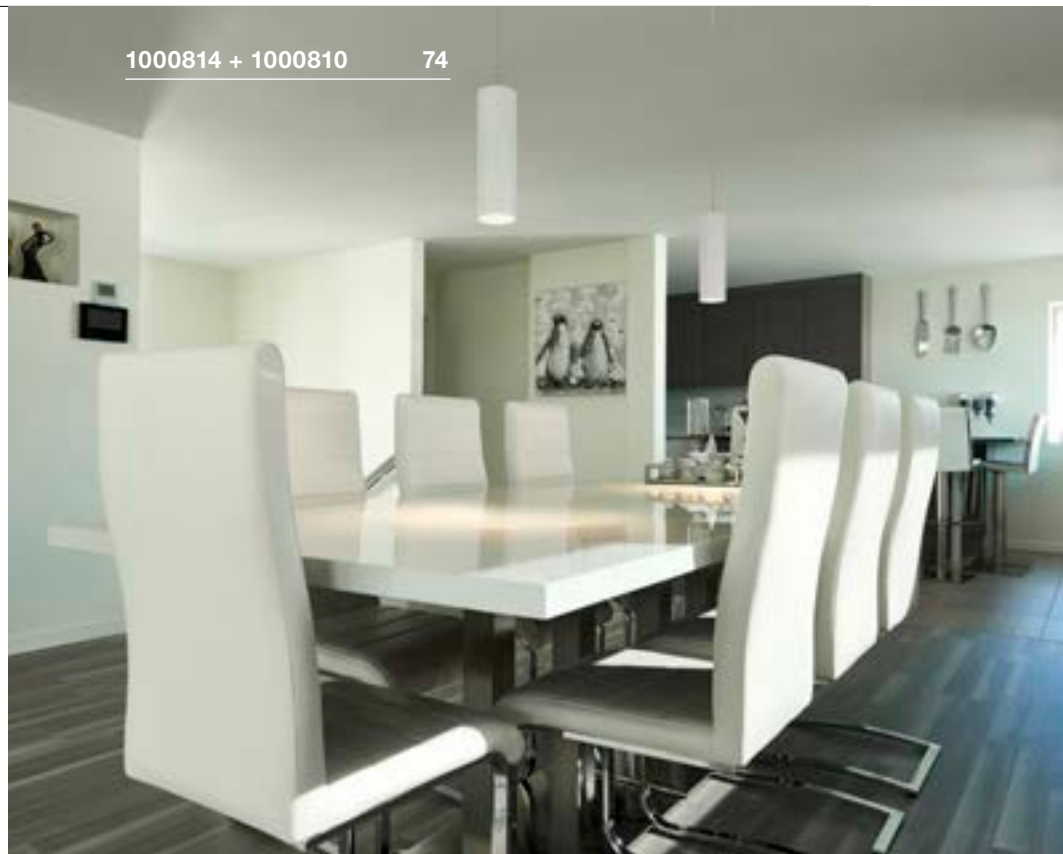

1000814 + 1000810 74



1000813 + 1000810 74

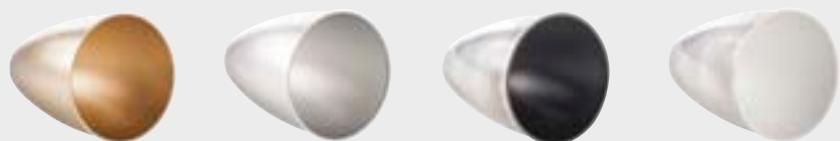

Reflekt or 28° – wechseln Sie bei dieser Leuchte den Reflekt or aus und erhalten durch die verschiedenen Farben (gold, grau, schwarz und weiß) eine andere neue Lichtwirkung.



134011

75

134001

75

LIGHT PIPE 60/90
PD, TRIAC

890

A-A++ Spektrum
A++-ELED
INSIDE

- Höhe einstellbar

Produktangaben

220-240V ~50/60Hz

Systemleistung: 11W

Material: Aluminium / Polymethylacrylat (PMMA)

Dimmbar: Triac C, Triac L

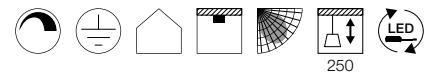

250



20000

Maßzeichnung

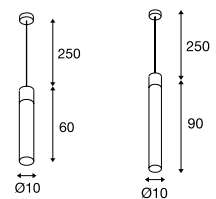

Variante

Art. Nr.

630lm | 2700K | CRI>80 | H: 60 cm | 1,88 kg

□ weiß

134001

630lm | 2700K | CRI>80 | H: 90 cm | 2,1 kg

□ weiß

134011

LISENNE
PD, E27

890

E-A++ Spektrum
A++-E

- Basaltstein & Rauchglas
- Höhe einstellbar

Produktangaben

220-240V ~50/60Hz
Material: Basalt / Glas

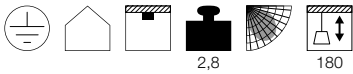

2,8

180

Maßzeichnung

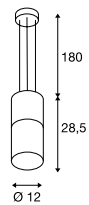

Leuchtmittelpfhlung

LED E27 7,1W 330°
2700K 806lm EEC=A+
8kWh/1000h
Art. Nr. 1001756



Leuchtmittelangaben

max. 23W
Ø: 5,9 cm max. L: 15 cm max.

Variante	Art. Nr.
E27 ■ grau / braun	155714



155714 76



149380 77

COMMO
PD, TCR-TSE

B-A++ Spektrum A++-E



Produktangaben

230V ~50Hz
Material: Stahl / Glas

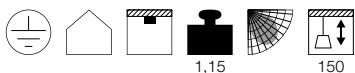

Maßzeichnung

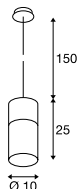

Leuchtmittlempfehlung

GX53 7,5W 120°
3000K 620lm EEK=A+
8kWh/1000h
Art. Nr. 1001220



LED GX53 7,5W 25°
3000K 450lm EEK=A
8kWh/1000h
Art. Nr. 550082



Leuchtmittelangaben

max. 13W TCR-TSE

Variante	Art. Nr.
GX53 TCR-TSE	
■ chrom	149380

TONGA®
PD, E14



E-A++ Spektrum A++-E



Produktangaben

220-240V ~50/60Hz
Material: Aluminium / Glas

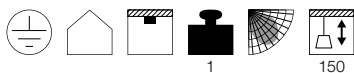

Maßzeichnung

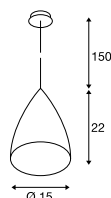

Leuchtmittlempfehlung

E14 3,4W 260°
3000K 250lm EEK=A+
4kWh/1000h
Art. Nr. 560362



LED E14 6,5W 280°
3000K 480lm EEK=A+
7kWh/1000h
Art. Nr. 560372



Leuchtmittelangaben

max. 60W C35
Ø: 5 cm max. L: 13 cm max.

Variante	Art. Nr.
E14 C35	
■ grau / glänzend milchig	133444

BIBA
PD, E14

E-A++ Spektrum A++-E

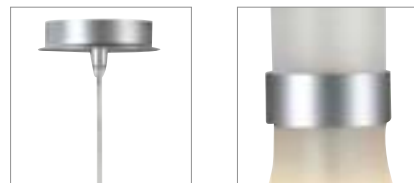

Produktangaben

230V ~50Hz
Material: Aluminium / Glas

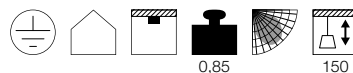

Maßzeichnung

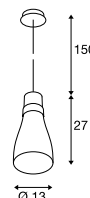

Leuchtmittlempfehlung

LED E14 6,5W 280°
3000K 480lm EEK=A+
7kWh/1000h
Art. Nr. 560372



Leuchtmittelangaben

max. 60W C35
Ø: 5 cm max. L: 13 cm max.

Variante	Art. Nr.
E14 C35	
■ aluminium / weiß	133464

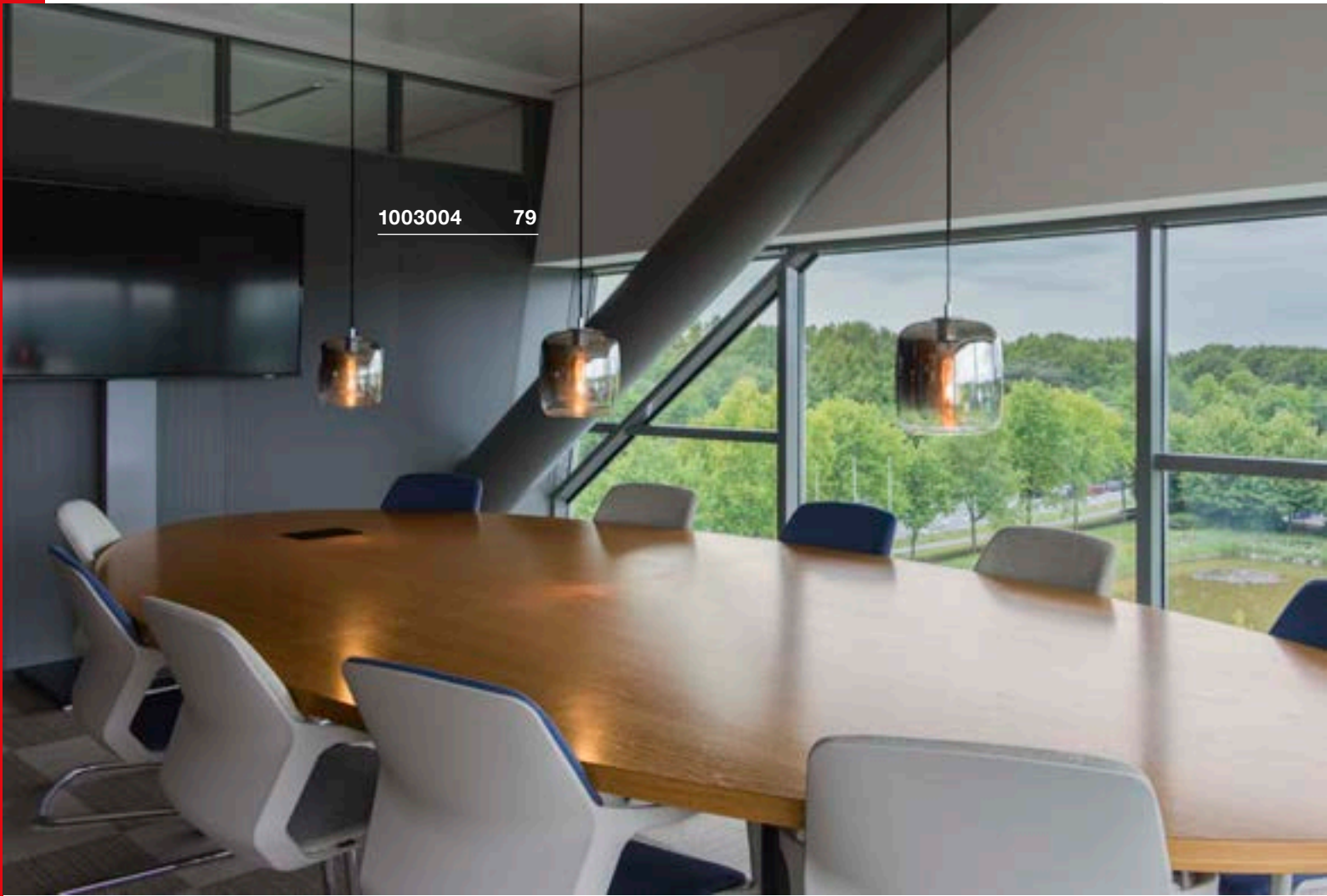

1003004 79

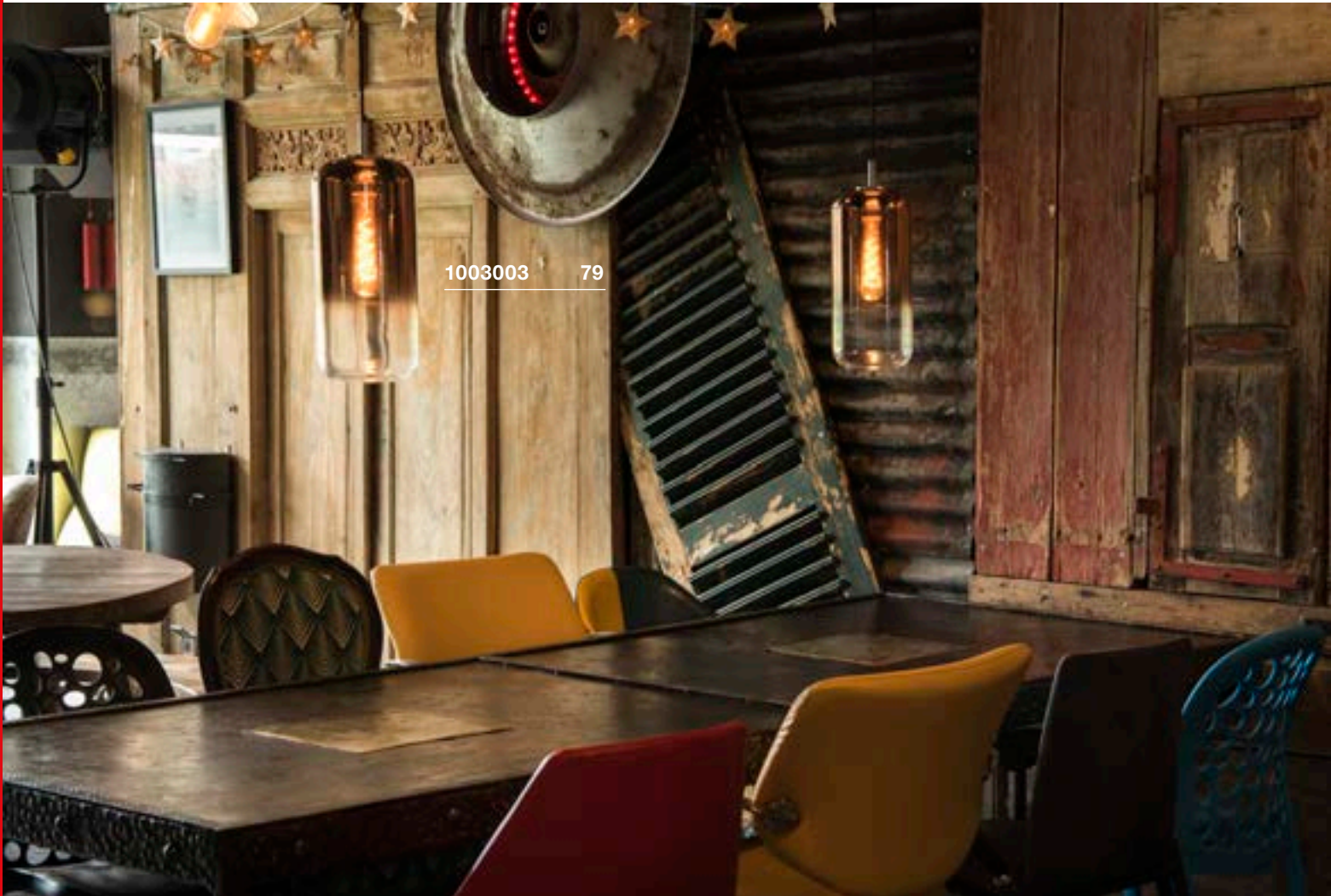

1003003 79

PANTILO 20
PD, E27



- Verchromter hochwertiger Glasschirm
- Durch individuelle Zusammenstellung zur Leuchtenwolke kombinierbar

Produktangaben

200-240V ~50/60Hz
Material: Glas
Produktmaße: Ø: 20 cm H: 21,3 cm

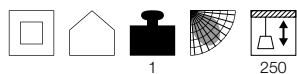

Hinweis

Kombinierbar mit dem Zubehör Fitu Mix & Match auf Seite 40

PANTILO 28
PD, E27



- Verchromter hochwertiger Glasschirm
- Durch individuelle Zusammenstellung zur Leuchtenwolke kombinierbar

Produktangaben

200-240V ~50/60Hz
Material: Glas
Produktmaße: Ø: 28 cm H: 17,2 cm



Hinweis

Kombinierbar mit dem Zubehör Fitu Mix & Match auf Seite 40

PANTILO 16
PD, E27



- Verchromter hochwertiger Glasschirm
- Durch individuelle Zusammenstellung zur Leuchtenwolke kombinierbar

Produktangaben

200-240V ~50/60Hz
Material: Glas
Produktmaße: Ø: 16 cm H: 35 cm



Hinweis

Kombinierbar mit dem Zubehör Fitu Mix & Match auf Seite 40

Leuchtmittelangaben

max. 15W

Variante	Art. Nr.
E27	
chrom	1003004
E27	
kupfer	1003005

Leuchtmittelangaben

max. 15W

Variante	Art. Nr.
E27	
chrom	1003006
E27	
kupfer	1003007

Leuchtmittelangaben

max. 15W

Variante	Art. Nr.
E27	
chrom	1003002
E27	
kupfer	1003003

SUN / BIG SUN
PD, E27



Produktangaben

230V ~50Hz
Material: Stahl / Glas

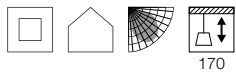

Maßzeichnung

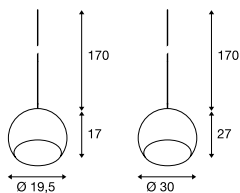

Hinweis

Offenes Kabelend
Kombinierbar mit dem Zubehör Fitu Mix & Match auf Seite 40

Leuchtmittlempfehlung

LED E27 14,5W 200°
2700K 1521lm EEK=A+
15kWh/1000h
Art. Nr. 560422

LED E27 7W 280°
2700K 790lm EEK=A++
7kWh/1000h
Art. Nr. 1002124

Leuchtmittelangaben

max. 60W
Ø: 7 cm max. L: 17 cm max.

Variante	Art. Nr.
E27 Ø: 19,5 cm 0,73 kg weiß / chrom	1002045
E27 Ø: 30 cm 1,83 kg weiß / chrom	1002046

BRENDA
PD, TRIAC



Produktangaben

220-240V ~50/60Hz | 500mA
Systemleistung: 21W
Material: Aluminium / Glas
Dimmbar: Triac C

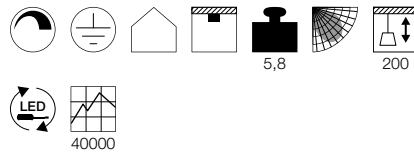

Maßzeichnung

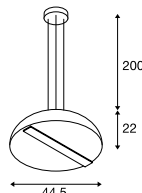

Hinweis

Offenes Kabelend
Kombinierbar mit dem Zubehör Fitu Mix & Match auf Seite 40

Leuchtmittlempfehlung

LED E27 14,5W 200°
2700K 1521lm EEK=A+
15kWh/1000h
Art. Nr. 560422

LED E27 7W 280°
2700K 790lm EEK=A++
7kWh/1000h
Art. Nr. 1002124

Leuchtmittelangaben

max. 60W
Ø: 7 cm max. L: 17 cm max.

Variante	Art. Nr.
2000lm 3000K CRI>80 weiß / matt grau	157701

ROTOBALL 25/40/50
PD, E27



Produktangaben

230V ~50Hz
Material: Stahl / Polyethylen (PE)

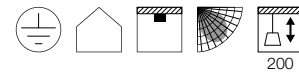

Maßzeichnung

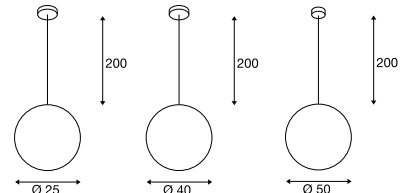

Hinweis

Offenes Kabelend
Kombinierbar mit dem Zubehör Fitu Mix & Match auf Seite 40

Leuchtmittlempfehlung

LED E27 14,5W 200°
2700K 1521lm EEK=A+
15kWh/1000h
Art. Nr. 560422

LED E27 9,5W 240°
RGBW 806lm EEK=A+
10kWh/1000h
Art. Nr. 1001917

Leuchtmittelangaben

max. 24W
Ø: Art. Nr. 165390 7 cm max.
Ø: Art. Nr. 165410 9,5 cm max.
Ø: Art. Nr. 165400 9,5 cm max.

Variante	Art. Nr.
E27 Ø: 25 cm 1,25 kg weiß / grau	165390
E27 Ø: 40 cm 2,4 kg weiß / grau	165410
E27 Ø: 50 cm 3,6 kg weiß / grau	165400

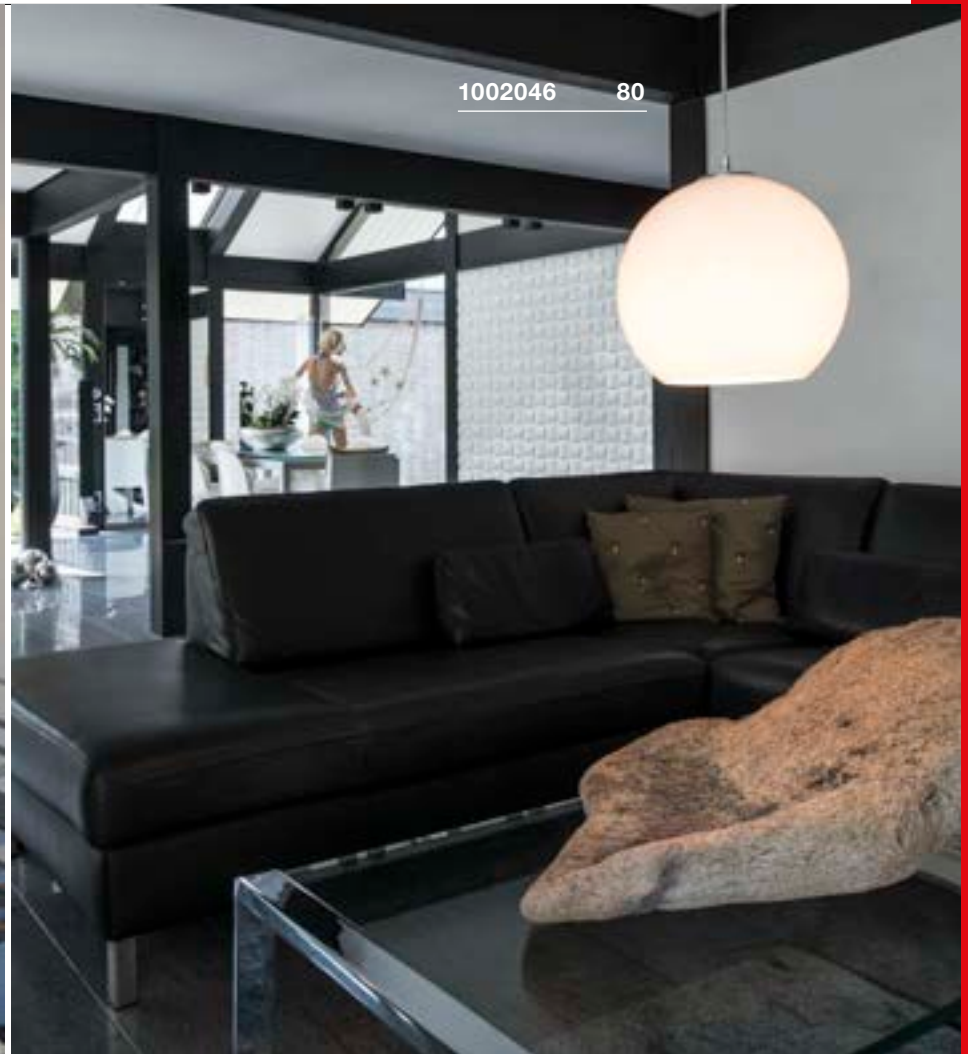

SOPRANA
PD, E27



E-A++ Spektrum A++-E



- Höhe einstellbar
- Acrylglasabdeckung an der Unterseite des Schirms

Produktangaben

230V ~50Hz
Material: Textil / Acryl

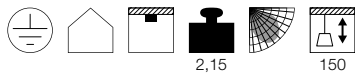

Maßzeichnung

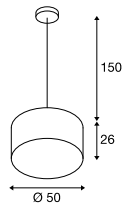

Leuchtmittlempfehlung

LED E27 9,1W 240°
2700K 760lm EEK=A+
10kWh/1000h
Art. Nr. 560402



LED E27 5W 330°
2000K 500lm EEK=A+
5kWh/1000h
Art. Nr. 560741



Leuchtmittelangaben

3x max. 60W
L: 16,5 cm max.

Variante	Art. Nr.
E27	
□ weiß	155462
E27	
■ beige	155463

BISHADE
PD, E27



A-A++ Spektrum A+++-E



- Doppelter konischer Leuchtschirm
- Höhe einstellbar

Produktangaben

230V ~50Hz
Material: Textil / Stahl

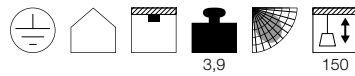

Maßzeichnung

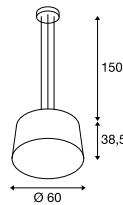

Leuchtmittlempfehlung

LED E27 9,1W 240°
2700K 760lm EEK=A+
10kWh/1000h
Art. Nr. 560402



LED E27 7W 280°
2200-2700K 830lm EEK=A++
7kWh/1000h
Art. Nr. 1002126



Leuchtmittelangaben

3x max. 23W
L: 17 cm max.

Variante	Art. Nr.
E27	
■ schwarz / transparent	155650





1002947 83

ACCANTO
PD, E27



E-A++ Spektrum A++-E

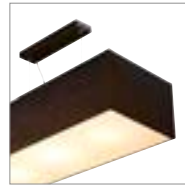

- Acrylabdeckung an der Unterseite des Schirms
- Höhe einstellbar

Produktangaben

220-240V ~50/60Hz
Material: Stahl / Textil
Produktmaße: L: 80 cm B: 30 cm H: 20 cm

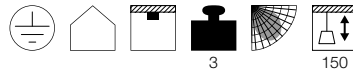

155871 83

TRIADEM
PD, E27

E-A++ Spektrum A++-E

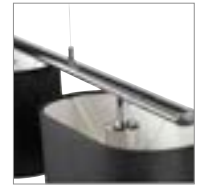

- Höhe einstellbar

Produktangaben

230V ~50Hz
Material: Textil / Stahl

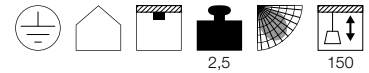

Maßzeichnung

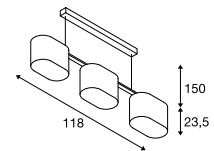

Leuchtmittlempfehlung

LED E27 14,5W 200°
2700K 1521lm EEK=A+
15kWh/1000h
Art. Nr. 560422



LED E27 9W 240°
2700-6500K 806lm EEK=A+
9kWh/1000h
Art. Nr. 1001916



Leuchtmittelangaben

3x max. 40W
L: 13 cm max.

Variante	Art. Nr.
E27	
■ schwarz / chrom	1002946
E27	
■ weiß / chrom	1002947

Leuchtmittlempfehlung

LED E27 14,5W 200°
2700K 1521lm EEK=A+
15kWh/1000h
Art. Nr. 560422



LED E27 9W 240°
2700-6500K 806lm EEK=A+
9kWh/1000h
Art. Nr. 1001916



Leuchtmittelangaben

3x max. 60W
L: 14 cm max.

Variante	Art. Nr.
E27	
■ schwarz / chrom	155870
E27	
■ weiß / chrom	155871

LASSON 10
PD, E27



E-A++ Spektrum A++-E



LASSON 45
PD, E27



E-A++ Spektrum A++-E

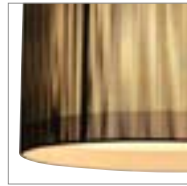
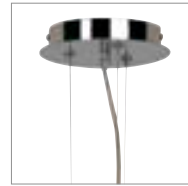

- Acrylglasabdeckung an der Unterseite des Schirms
- Höhe einstellbar

Produktangaben

230V ~50Hz
Material: Stahl / Textil

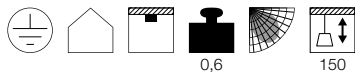

Maßzeichnung

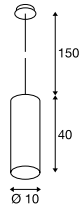

Produktangaben

230V ~50Hz
Material: Textil / Acryl

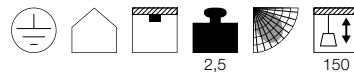

Maßzeichnung

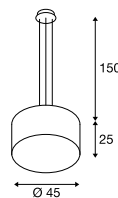

Leuchtmittlempfehlung

LED E27 9,1W 240°
2700K 760lm EEK=A+
10kWh/1000h
Art. Nr. 560402



LED E27 4,5W 280°
2200-2700K 500lm EEK=A++
5kWh/1000h
Art. Nr. 1002125



Leuchtmittelangaben

max. 40W

Variante	Art. Nr.
E27	
■ schwarz	155380

Leuchtmittlempfehlung

LED E27 9,1W 240°
2700K 760lm EEK=A+
10kWh/1000h
Art. Nr. 560402



LED E27 7W 280°
2200-2700K 830lm EEK=A++
7kWh/1000h
Art. Nr. 1002126



Leuchtmittelangaben

3x max. 60W
L: 13 cm max.

Variante	Art. Nr.
E27	
■ schwarz	155300



155380 84



155300 84



155290 85

LASSON 80
PD, E27

889

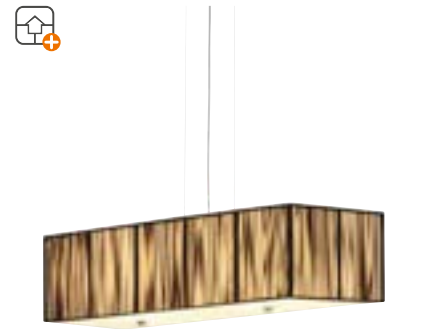
E-A++ Spektrum
A++-E

- Glasabdeckung an der Unterseite des Schirms
- Höhe einstellbar

Produktangaben230V ~50Hz
Material: Textil / Glas

4,4

150

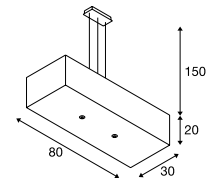
Maßzeichnung**Leuchtmittlempfehlung**LED E27 14,5W 200°
2700K 1521lm EEK=A+
15kWh/1000h

Art. Nr. 560422

LED E27 9W 240°
2700-6500K 806lm EEK=A+
9kWh/1000h

Art. Nr. 1001916







**Leuchtmittelangaben**4x max. 60W
Ø: 8 cm max. L: 18 cm max.

Variante	Art. Nr.
E27 ■ schwarz	155290

MEDO LEUCHTENSERIE.

PENDEL- ODER DECKENLEUCHE.

	MEDO 30 CL, 1-10V	MEDO 40 CL, 1-10V	MEDO 60 CL, 1-10V	MEDO 90 CL, 1-10V
Beispiel				
Leuchtmittel				
Größe	Ø: 30 cm	Ø: 40 cm	Ø: 60 cm	Ø: 90 cm
Lichtstärke	1000lm	2000lm	3500lm	11000lm
UGR	25	25	22	25
Dimmbar	1-10V	1-10V	1-10V	1-10V
Abhängeset (exkl.)	1,5 m 5 m	1,5 m 5 m	1,5 m 5 m	1,5 m 5 m

	MEDO 30 CL, TRIAC	MEDO 40 CL, TRIAC	
Beispiel			
Leuchtmittel			
Größe-Ø	Ø: 30 cm	Ø: 40 cm	
Lichtstärke	1200lm	2125lm	
UGR	25	25	
Dimmbar	Triac C, Triac L	Triac C, Triac L	
Abhängeset (exkl.)	1,5 m 5 m	1,5 m 5 m	 <p>Diese MEDO Variante wird mit TRIAC Dimmer gedimmt!</p>











	MEDO 60 CL, square, 1-10V	MEDO 60 CL, square, DALI	
Beispiel			
Leuchtmittel			
Größe	B L: 60 cm	B L: 60 cm	
Lichtstärke	3300 lm	3300 lm	
UGR	22	22	
Dimmbar	1-10V	Dali	
Abhängeset (exkl.)	1,5 m 5 m	1,5 m 5 m	

	MEDO RING 60 PD, 1-10V	MEDO RING 90 PD, 1-10V	MEDO RING 60 PD, DALI
Beispiel			
Leuchtmittel			
Größe	Ø: 60 cm	Ø: 90 cm	Ø: 60 cm
Lichtstärke	2000lm	3945lm	2000lm
UGR	-	-	22
Dimmbar	1-10V	1-10V	Dali
Abhängeset	nicht nötig, (inkl.) – reine Pendelleuchte	nicht nötig, (inkl.) – reine Pendelleuchte	nicht nötig, (inkl.) – reine Pendelleuchte

MEDO LEUCHTENSERIE.

PENDEL- ODER DECKENLEUCHE.

	MEDO 30 CORONA CW, TRIAC	MEDO 40 CORONA CW, TRIAC	MEDO 60 CORONA CW, TRIAC	MEDO 90 CORONA CL, TRIAC
Beispiel				
Leuchtmittel				
Größe	Ø: 30 cm	Ø: 40 cm	Ø: 60 cm	Ø: 90 cm
Lichtstärke	Down: 1230/1280lm Up: 20lm	Down: 2750/2900lm Up: 50lm	Down: 4350/4750lm Up: 120lm	Down: 9500/10100lm Up: 125lm
UGR	25	25	25	25
Dimmbar	Triac C	Triac C	Triac C	Triac C
Abhängeset (exkl.)	1,5 m 5 m	1,5 m 5 m	1,5 m 5 m	1,5 m 5 m

	MEDO 30 CORONA CW, DALI	MEDO 40 CORONA CW, DALI	MEDO 60 CORONA CW, DALI	MEDO 90 CORONA CL, DALI
Beispiel				
Leuchtmittel				
Größe	Ø: 30 cm	Ø: 40 cm	Ø: 60 cm	Ø: 90 cm
Lichtstärke	Down: 1230/1280lm Up: 20lm	Down: 2750/2900lm Up: 50lm	Down: 4350/4750lm Up: 120lm	Down: 9500/10100lm Up: 125lm
UGR	25	25	25	25
Dimmbar	DALI	DALI	DALI	DALI
Abhängeset (exkl.)	1,5 m 5 m	1,5 m 5 m	1,5 m 5 m	1,5 m 5 m

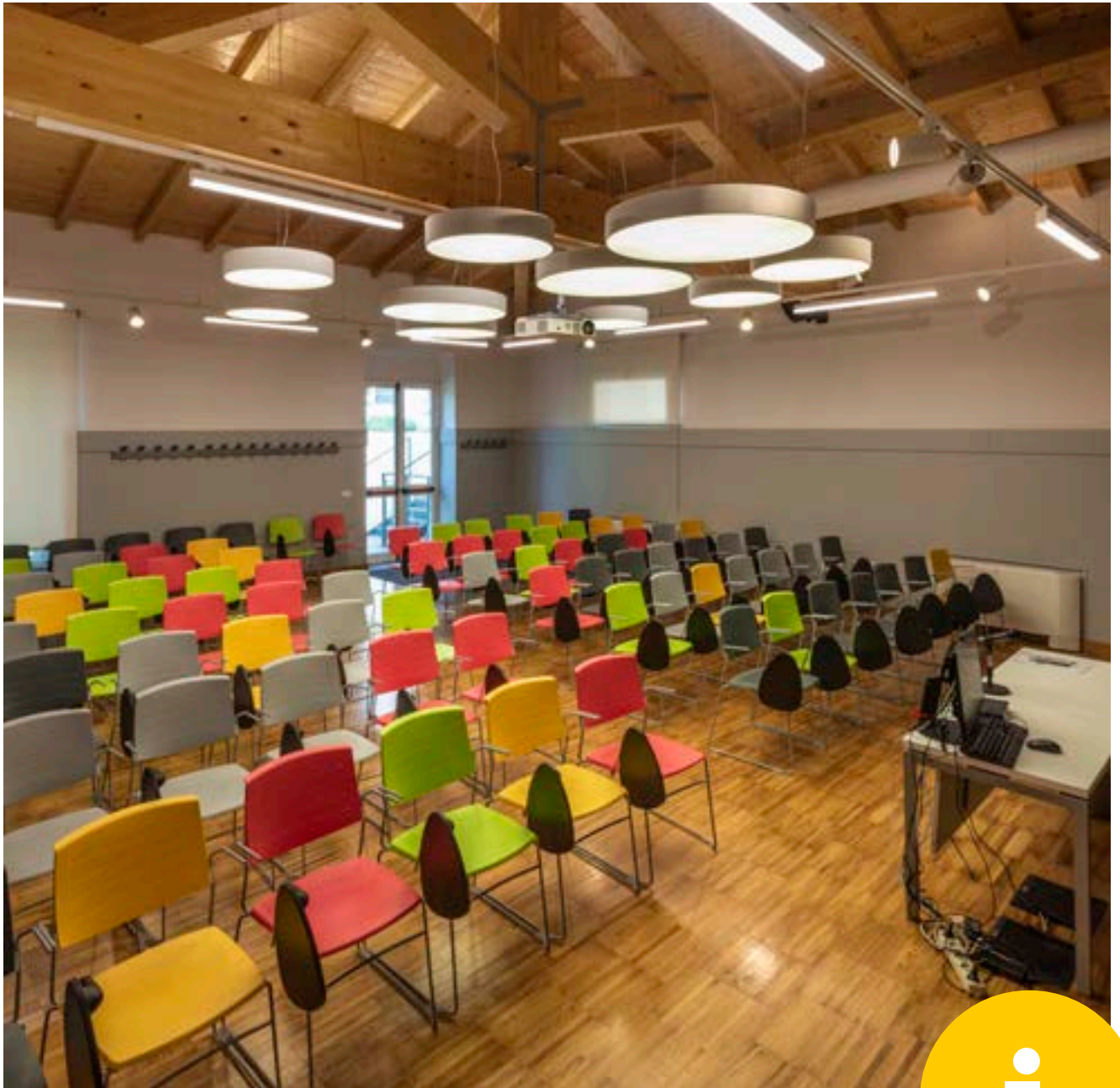

Corona Effekt Diese MEDO Varianten verfügen über einen homogenen indirekten Lichtaustritt nach oben.



Farbtemperatur – Bei dieser MEDO Variante können Sie die Farbtemperatur selber wählen. Durch den Schalter auf der Rückseite kann zwischen 3000K und 4000K gewählt werden.

MEDO 30
CL, TRIAC



A-A++ Spektrum
A++-E



LED
INSIDE



• Durch das additional erhältliche Zubehör zur Pendelleuchte umrüstbar

Produktangaben

220-240V ~50/60Hz | 350mA
Systemleistung: 16W
Material: Aluminium / Polymethylacrylat (PMMA)
Dimmbar: Triac C, Triac L

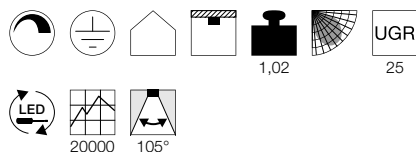

Maßzeichnung

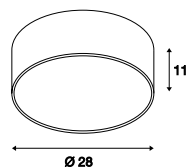

Hinweis

Abhängeset exkl.

Zubehörempfehlung

- Abhängeset 1,5m
Art. Nr. **135250**
- Abhängeset 1,5m
Art. Nr. **135251**
- Abhängeset 1,5m
Art. Nr. **135254**
- Abhängeset 5m
Art. Nr. **1001950**
- Abhängeset 5m
Art. Nr. **1001951**
- Abhängeset 5m
Art. Nr. **1001952**

Variante	Art. Nr.
1200lm 3000K CRI>80 ■ schwarz	135020
1200lm 3000K CRI>80 □ weiß	135021
1200lm 3000K CRI>80 ■ grau	135024
1200lm 3000K CRI>80 ■ rot	135026



135250 90

135120 92

135020 90

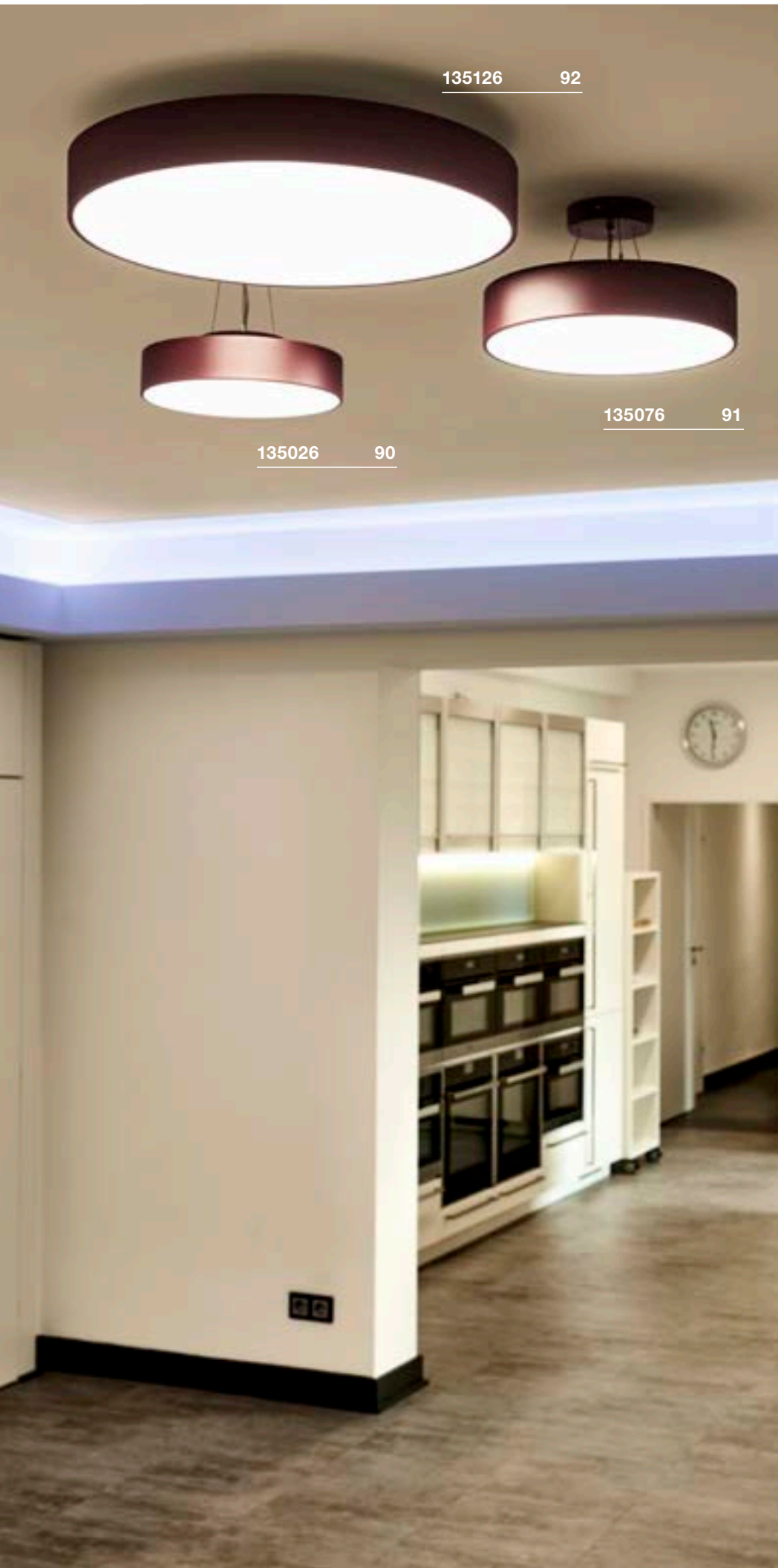

135126 92

135026 90

135076 91

MEDO 40
CL, TRIAC



A-A++ Spektrum
A++-E



LED
INSIDE



- Durch das additional erhältliche Zubehör zur Pendelleuchte umrüstbar

Produktangaben

220-240V ~50/60Hz | 700mA

Systemleistung: 31W

Material: Aluminium / Polymethylacrylat (PMMA)

Dimmbar: Triac C, Triac L

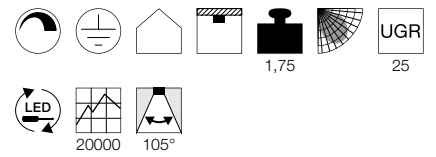

Maßzeichnung

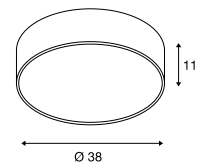

Hinweis

Abhängeset exkl.

Zubehöreffahrung

- Abhängeset 1,5m
Art. Nr. 135250
- Abhängeset 1,5m
Art. Nr. 135251
- Abhängeset 1,5m
Art. Nr. 135254
- Abhängeset 5m
Art. Nr. 1001950
- Abhängeset 5m
Art. Nr. 1001951
- Abhängeset 5m
Art. Nr. 1001952

Variante	Art. Nr.
2125lm 3000K CRI>80 ■ schwarz	135070
2125lm 3000K CRI>80 □ weiß	135071
2125lm 3000K CRI>80 ■ grau	135074
2125lm 3000K CRI>80 ■ rot	135076

MEDO 30
CL, 1-10V



A-A++ Spektrum A++-E



LED INSIDE



• Durch das additional erhältliche Zubehör zur Pendelleuchte umrüstbar

MEDO 40
CL, 1-10V



A-A++ Spektrum A++-E



LED INSIDE

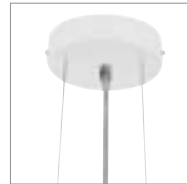

• Durch das additional erhältliche Zubehör zur Pendelleuchte umrüstbar

MEDO 60
CL, 1-10V



A-A++ Spektrum A++-E



LED INSIDE



• Durch das additional erhältliche Zubehör zur Pendelleuchte umrüstbar

Produktangaben

220-240V ~50/60Hz | 350mA
Systemleistung: 15W
Material: Aluminium / Polymethylacrylat (PMMA)
Dimmbar: 1-10V

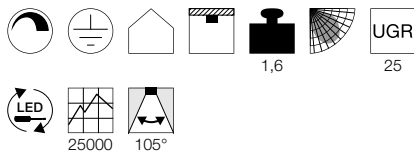

Maßzeichnung

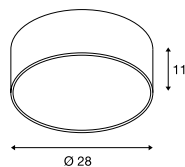

Hinweis

Abhängeset exkl.

Zubehörempfehlung

- Abhängeset 1,5m
Art. Nr. 135250
- Abhängeset 1,5m
Art. Nr. 135251
- Abhängeset 1,5m
Art. Nr. 135254
- Abhängeset 5m
Art. Nr. 1001950
- Abhängeset 5m
Art. Nr. 1001951
- Abhängeset 5m
Art. Nr. 1001952

Variante	Art. Nr.
1000lm 3000K CRI>80	
■ schwarz	1000855
1000lm 3000K CRI>80	
□ weiß	1000856
1000lm 3000K CRI>80	
■ grau	1000857

Produktangaben

120-240V ~50/60Hz | 700mA
Systemleistung: 29W
Material: Aluminium / Polymethylacrylat (PMMA)
Dimmbar: 1-10V

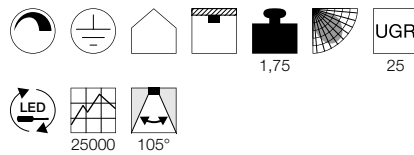

Maßzeichnung

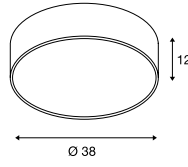

Hinweis

Abhängeset exkl.

Zubehörempfehlung

- Abhängeset 1,5m
Art. Nr. 135250
- Abhängeset 1,5m
Art. Nr. 135251
- Abhängeset 1,5m
Art. Nr. 135254
- Abhängeset 5m
Art. Nr. 1001950
- Abhängeset 5m
Art. Nr. 1001951
- Abhängeset 5m
Art. Nr. 1001952

Variante	Art. Nr.
2000lm 3000K CRI>80	
■ schwarz	1000864
2000lm 3000K CRI>80	
□ weiß	1000865
2000lm 3000K CRI>80	
■ grau	1000866

Produktangaben

100-240V ~50/60Hz | 1000mA
Systemleistung: 40W
Material: Aluminium / Polymethylacrylat (PMMA)
Dimmbar: 1-10V

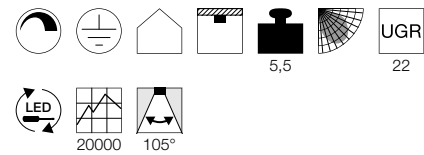

Maßzeichnung

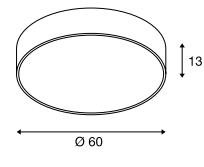

Hinweis

Abhängeset exkl.

Zubehörempfehlung

- Abhängeset 1,5m
Art. Nr. 135250
- Abhängeset 1,5m
Art. Nr. 135251
- Abhängeset 1,5m
Art. Nr. 135254
- 1-10V Dimming
Art. Nr. 470505
- Abhängeset 5m
Art. Nr. 1001950
- Abhängeset 5m
Art. Nr. 1001951
- Abhängeset 5m
Art. Nr. 1001952

Variante	Art. Nr.
3500lm 3000K CRI>80	
■ schwarz	135120
3500lm 3000K CRI>80	
□ weiß	135121
3500lm 3000K CRI>80	
■ grau	135124
3500lm 3000K CRI>80	
■ rot	135126

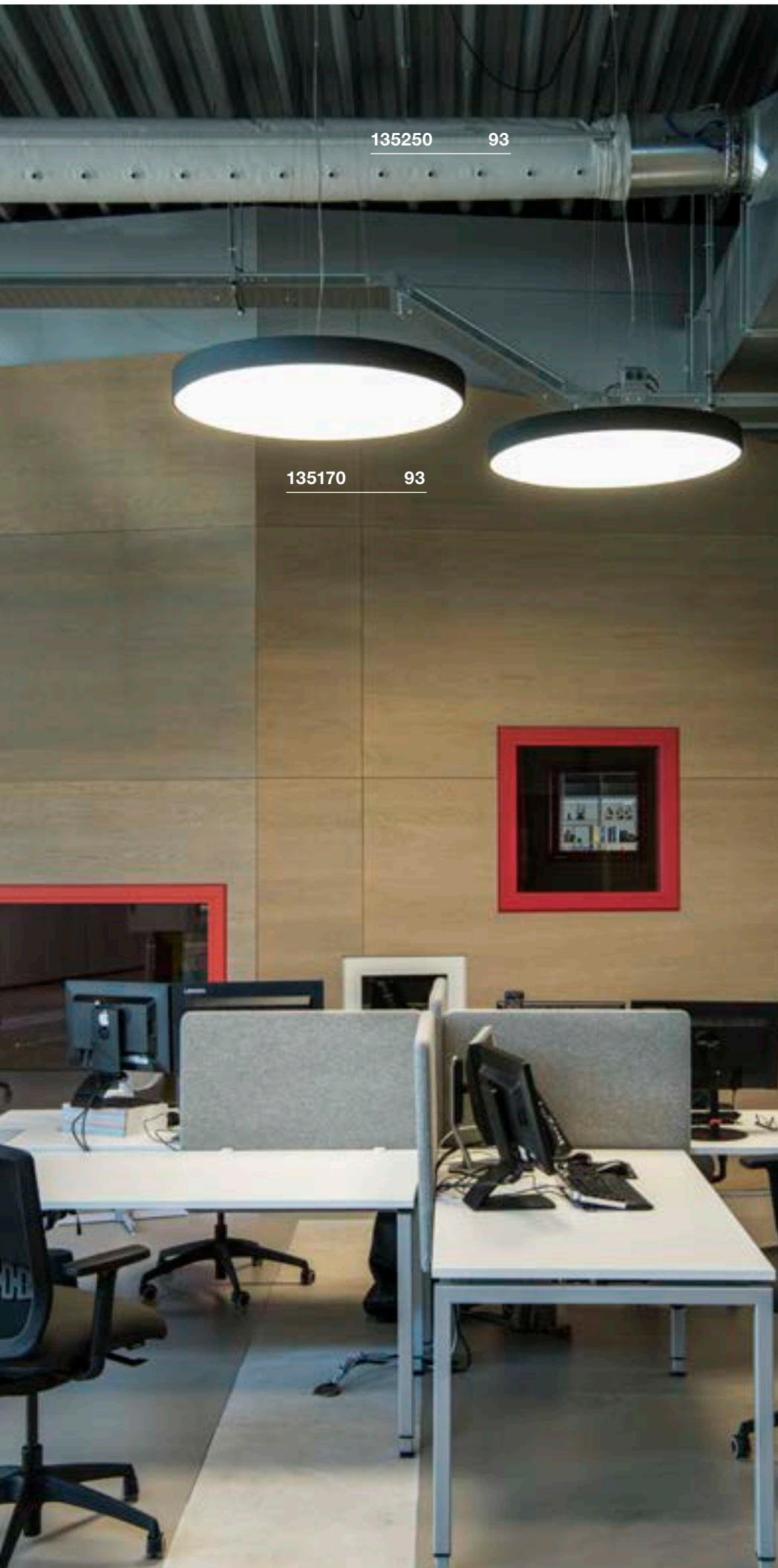

135250 93

135170 93

MEDO 90
CL, 1-10V



A-A++ Spektrum A++-E



LED INSIDE



- Durch das additional erhältliche Zubehör zur Pendelleuchte umrüstbar

Produktangaben

220-240V ~50/60Hz | 2900mA
Systemleistung: 119W
Material: Aluminium / Polymethylacrylat (PMMA)
Dimmbar: 1-10V

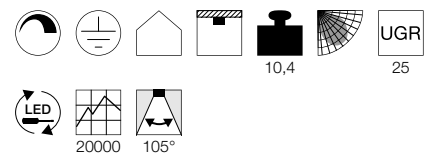

Maßzeichnung

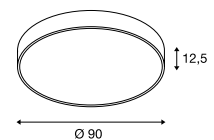

Hinweis

Abhängeset exkl.

Zubehöreffahrung

- Abhängeset 1,5m
Art. Nr. 135250
- Abhängeset 1,5m
Art. Nr. 135251
- Abhängeset 1,5m
Art. Nr. 135254
- 1-10V Dimming
Art. Nr. 470505
- Abhängeset 5m
Art. Nr. 1001950
- Abhängeset 5m
Art. Nr. 1001951
- Abhängeset 5m
Art. Nr. 1001952

Variante	Art. Nr.
11000lm 3000K CRI>80	
■ schwarz	135170
11000lm 3000K CRI>80	
□ weiß	135171
11000lm 3000K CRI>80	
■ grau	135174
11000lm 3000K CRI>80	
■ rot	135176

MEDO 30 CORONA
CW, TRIAC



A-A++ Spektrum
A++-E



LED
INSIDE



- Mit Corona Effekt
- Farbtemperatur (3000K/4000K) über Schalter einstellbar
- Durch das additional erhältliche Zubehör zur Pendelleuchte umrüstbar

Produktangaben

220-240V ~50/60Hz | 350mA
Systemleistung: 15W
Material: Aluminium / Polycarbonat (PC)
Dimmbar: Triac C

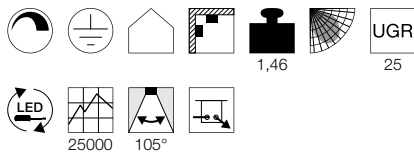

Maßzeichnung

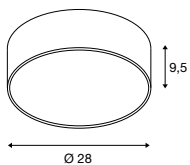

Hinweis

Abhängeset exkl.

Zubehörempfehlung

- Abhängeset 1,5m
Art. Nr. 135250
- Abhängeset 1,5m
Art. Nr. 135251
- Abhängeset 1,5m
Art. Nr. 135254
- Abhängeset 5m
Art. Nr. 1001950
- Abhängeset 5m
Art. Nr. 1001951
- Abhängeset 5m
Art. Nr. 1001952

Variante	Art. Nr.
Down: 1230/1280lm 3000/4000K CRI>80 Up: 20lm 3000/4000K CRI>80	
■ schwarz	1001877
Down: 1230/1280lm 3000/4000K CRI>80 Up: 20lm 3000/4000K CRI>80	
□ weiß	1001881
Down: 1230/1280lm 3000/4000K CRI>80 Up: 20lm 3000/4000K CRI>80	
■ grau	1001882

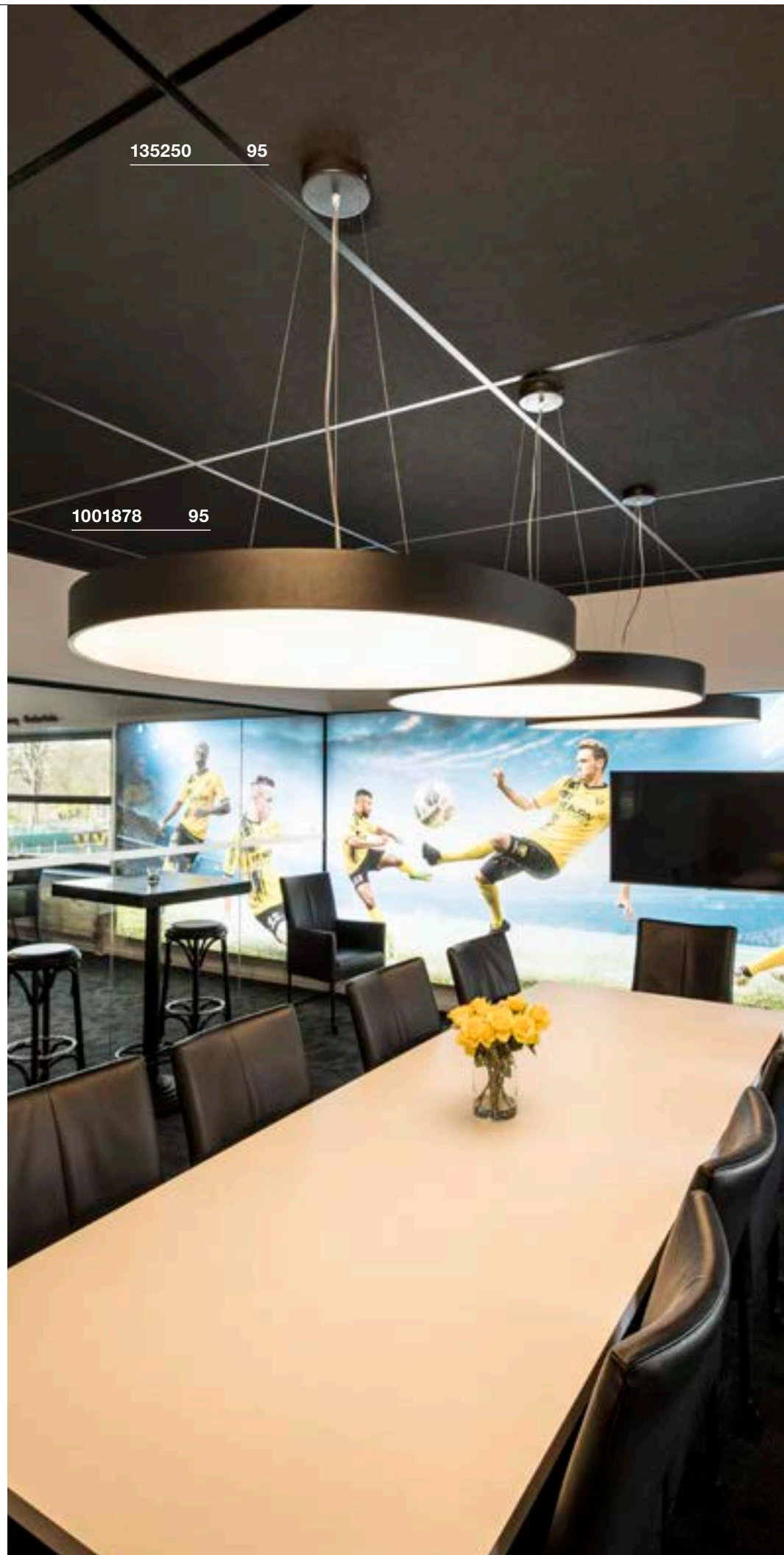

135250 95

1001878 95

MEDO 40 CORONA
CW, TRIAC



A-A++ Spektrum A++-E



- Mit Corona Effekt
- Farbtemperatur (3000K/4000K) über Schalter einstellbar
- Durch das additional erhältliche Zubehör zur Pendelleuchte umrüstbar

Produktangaben

220-240V ~50/60Hz | 700mA
Systemleistung: 30W
Material: Aluminium / Polycarbonat (PC)
Dimmbar: Triac C

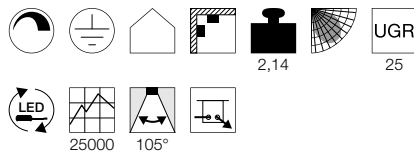

Maßzeichnung

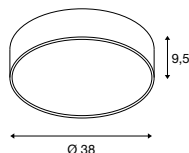

Hinweis

Abhängeset exkl.

Zubehörempfehlung

- Abhängeset 1,5m
Art. Nr. 135250
- Abhängeset 1,5m
Art. Nr. 135251
- Abhängeset 1,5m
Art. Nr. 135254
- Abhängeset 5m
Art. Nr. 1001950
- Abhängeset 5m
Art. Nr. 1001951
- Abhängeset 5m
Art. Nr. 1001952

Variante	Art. Nr.
Down: 2750/2900lm 3000/4000K CRI>80 Up: 50lm 3000/4000K CRI>80	
■ schwarz	1001883
Down: 2750/2900lm 3000/4000K CRI>80 Up: 50lm 3000/4000K CRI>80	
□ weiß	1001884
Down: 2750/2900lm 3000/4000K CRI>80 Up: 50lm 3000/4000K CRI>80	
■ grau	1001885

MEDO 60 CORONA
CW, TRIAC



A-A++ Spektrum A++-E



- Mit Corona Effekt
- Farbtemperatur (3000K/4000K) über Schalter einstellbar
- Durch das additional erhältliche Zubehör zur Pendelleuchte umrüstbar

Produktangaben

220-240V ~50/60Hz | 1050mA
Systemleistung: 40W
Material: Aluminium / Polycarbonat (PC)
Dimmbar: Triac C

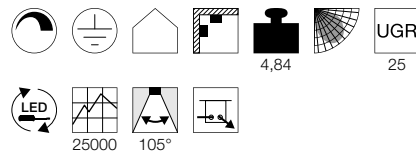

Maßzeichnung

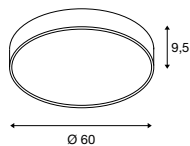

Hinweis

Abhängeset exkl.

Zubehörempfehlung

- Abhängeset 1,5m
Art. Nr. 135250
- Abhängeset 1,5m
Art. Nr. 135251
- Abhängeset 1,5m
Art. Nr. 135254
- Abhängeset 5m
Art. Nr. 1001950
- Abhängeset 5m
Art. Nr. 1001951
- Abhängeset 5m
Art. Nr. 1001952

Variante	Art. Nr.
Down: 4350/4750lm 3000/4000K CRI>80 Up: 120lm 3000/4000K CRI>80	
■ schwarz	1001886
Down: 4350/4750lm 3000/4000K CRI>80 Up: 120lm 3000/4000K CRI>80	
□ weiß	1001887
Down: 4350/4750lm 3000/4000K CRI>80 Up: 120lm 3000/4000K CRI>80	
■ grau	1001888

MEDO 90 CORONA
CL, TRIAC



A-A++ Spektrum A++-E



- Mit Corona Effekt
- Farbtemperatur (3000K/4000K) über Schalter einstellbar
- Durch das additional erhältliche Zubehör zur Pendelleuchte umrüstbar

Produktangaben

220-240V ~50/60Hz | 1050mA
Systemleistung: 78W
Material: Aluminium / Polycarbonat (PC)
Dimmbar: Triac C

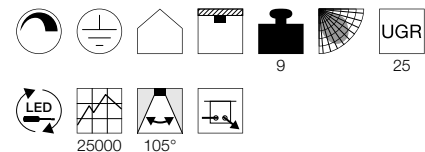

Maßzeichnung

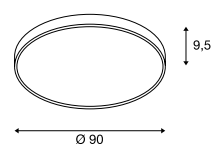

Hinweis

Abhängeset exkl.

Zubehörempfehlung

- Abhängeset 1,5m
Art. Nr. 135250
- Abhängeset 1,5m
Art. Nr. 135251
- Abhängeset 1,5m
Art. Nr. 135254
- Abhängeset 5m
Art. Nr. 1001950
- Abhängeset 5m
Art. Nr. 1001951
- Abhängeset 5m
Art. Nr. 1001952

Variante	Art. Nr.
Down: 9500/10100lm 3000/4000K CRI>80 Up: 125lm 3000/4000K CRI>80	
■ schwarz	1001878
Down: 9500/10100lm 3000/4000K CRI>80 Up: 125lm 3000/4000K CRI>80	
□ weiß	1001879
Down: 9500/10100lm 3000/4000K CRI>80 Up: 125lm 3000/4000K CRI>80	
■ grau	1001880

MEDO 30 CORONA
CW, DALI



A-A++ Spektrum A++-E



- Mit Corona Effekt
- Farbtemperatur (3000K/4000K) über Schalter einstellbar
- Durch das additional erhältliche Zubehör zur Pendelleuchte umrüstbar

Produktangaben

220-240V ~50/60Hz | 350mA
Systemleistung: 15W
Material: Aluminium / Polycarbonat (PC)
Dimmbar: Dali

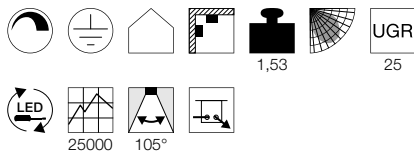

Maßzeichnung

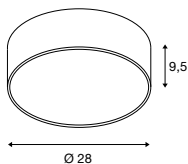

Hinweis

Abhängeset exkl.

Zubehörempfehlung

- Abhängeset 1,5m
Art. Nr. 135250
- Abhängeset 1,5m
Art. Nr. 135251
- Abhängeset 1,5m
Art. Nr. 135254
- Abhängeset 5m
Art. Nr. 1001950
- Abhängeset 5m
Art. Nr. 1001951
- Abhängeset 5m
Art. Nr. 1001952

Variante	Art. Nr.
Down: 1230/1280lm 3000/4000K CRI>80 Up: 20lm 3000/4000K CRI>80	
■ schwarz	1001889
Down: 1230/1280lm 3000/4000K CRI>80 Up: 20lm 3000/4000K CRI>80	
□ weiß	1001893
Down: 1230/1280lm 3000/4000K CRI>80 Up: 20lm 3000/4000K CRI>80	
■ grau	1001894

MEDO 40 CORONA
CW, DALI



A-A++ Spektrum A++-E



- Mit Corona Effekt
- Farbtemperatur (3000K/4000K) über Schalter einstellbar
- Durch das additional erhältliche Zubehör zur Pendelleuchte umrüstbar

Produktangaben

220-240V ~50/60Hz | 700mA
Systemleistung: 30W
Material: Aluminium / Polycarbonat (PC)
Dimmbar: Dali

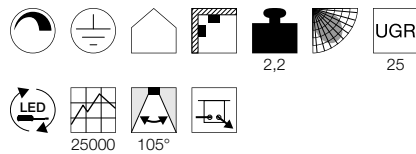

Maßzeichnung

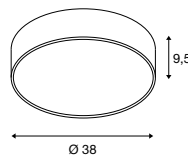

Hinweis

Abhängeset exkl.

Zubehörempfehlung

- Abhängeset 1,5m
Art. Nr. 135250
- Abhängeset 1,5m
Art. Nr. 135251
- Abhängeset 1,5m
Art. Nr. 135254
- Abhängeset 5m
Art. Nr. 1001950
- Abhängeset 5m
Art. Nr. 1001951
- Abhängeset 5m
Art. Nr. 1001952

Variante	Art. Nr.
Down: 2750/2900lm 3000/4000K CRI>80 Up: 50lm 3000/4000K CRI>80	
■ schwarz	1001895
Down: 2750/2900lm 3000/4000K CRI>80 Up: 50lm 3000/4000K CRI>80	
□ weiß	1001896
Down: 2750/2900lm 3000/4000K CRI>80 Up: 50lm 3000/4000K CRI>80	
■ grau	1001897

MEDO 60 CORONA
CW, DALI



A-A++ Spektrum A++-E



- Mit Corona Effekt
- Farbtemperatur (3000K/4000K) über Schalter einstellbar
- Durch das additional erhältliche Zubehör zur Pendelleuchte umrüstbar

Produktangaben

220-240V ~50/60Hz | 1000mA
Systemleistung: 40W
Material: Aluminium / Polycarbonat (PC)
Dimmbar: Dali

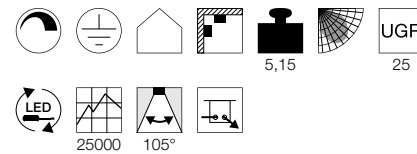

Maßzeichnung

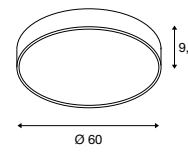

Hinweis

Abhängeset exkl.

Zubehörempfehlung

- Abhängeset 1,5m
Art. Nr. 135250
- Abhängeset 1,5m
Art. Nr. 135251
- Abhängeset 1,5m
Art. Nr. 135254
- Abhängeset 5m
Art. Nr. 1001950
- Abhängeset 5m
Art. Nr. 1001951
- Abhängeset 5m
Art. Nr. 1001952

Variante	Art. Nr.
Down: 4350/4750lm 3000/4000K CRI>80 Up: 120lm 3000/4000K CRI>80	
■ schwarz	1001898
Down: 4350/4750lm 3000/4000K CRI>80 Up: 120lm 3000/4000K CRI>80	
□ weiß	1001900
Down: 4350/4750lm 3000/4000K CRI>80 Up: 120lm 3000/4000K CRI>80	
■ grau	1001899

MEDO 60
CL, Square, 1-10V



A-A++ Spektrum
A++-E



- Durch das additional erhältliche Zubehör zur Pendelleuchte umrüstbar

Produktangaben

100-240V ~50/60Hz | 1000mA
Systemleistung: 39W
Material: Aluminium / Acryl
Dimmbar: 1-10V

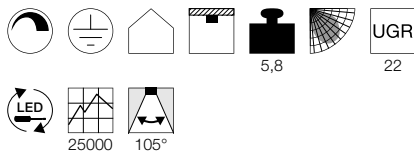

Maßzeichnung

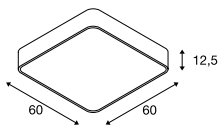

Hinweis

Abhängeset exkl.

Zubehörempfehlung

- Abhängeset 1,5m
Art. Nr. 135250
- Abhängeset 1,5m
Art. Nr. 135251
- Abhängeset 1,5m
Art. Nr. 135254
- 1-10V Dimming
Art. Nr. 470505
- Abhängeset 5m
Art. Nr. 1001950
- Abhängeset 5m
Art. Nr. 1001951
- Abhängeset 5m
Art. Nr. 1001952

Variante	Art. Nr.
3300lm 3000K CRI>80 ■ schwarz	1000725
3300lm 3000K CRI>80 □ weiß	1000726
3300lm 3000K CRI>80 ■ grau	1000727

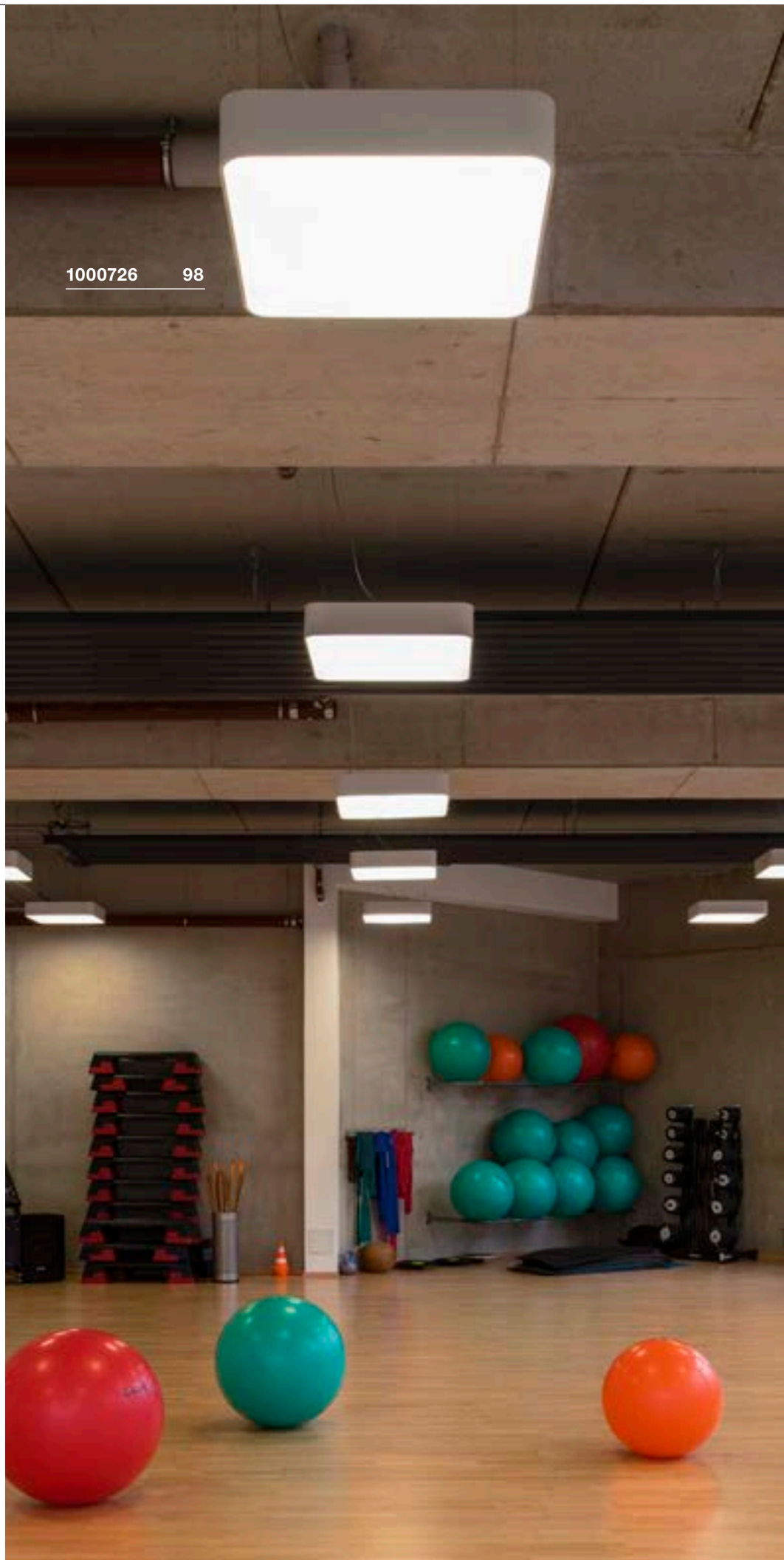

1000726 98

MEDO RING 60
PD, 1-10V



A-A++ Spektrum A++-E



• Höhe einstellbar

Produktangaben

120-240V ~50/60Hz | 700mA
Systemleistung: 35W
Material: Aluminium / Polymethylacrylat (PMMA)
Dimmbar: 1-10V

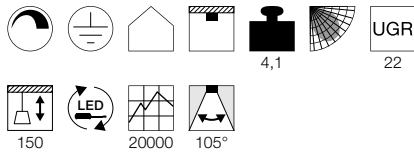

Maßzeichnung

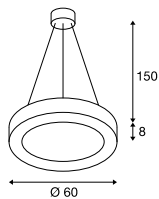

Zubehörempfehlung

1-10V Dimming
Art. Nr. 470505



Variante	Art. Nr.
2000lm 3000K CRI>80	
■ schwarz	133840
2095lm 3000K CRI>80	
□ weiß	133841

MEDO RING 90
PD, 1-10V



A-A++ Spektrum A++-E

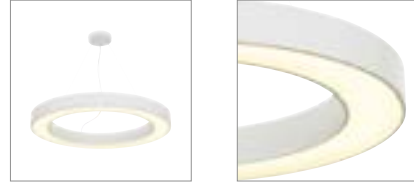

• Höhe einstellbar

Produktangaben

100-240V ~50/60Hz | 1200mA
Systemleistung: 58W
Material: Aluminium / Polymethylacrylat (PMMA)
Dimmbar: 1-10V

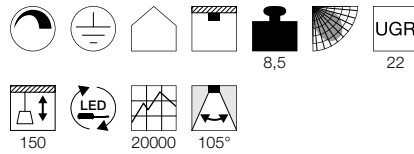

Maßzeichnung

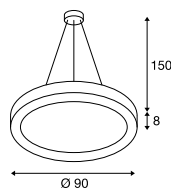

Zubehörempfehlung

1-10V Dimming
Art. Nr. 470505



Variante	Art. Nr.
3945lm 3000K CRI>80	
■ schwarz	133850
4185lm 3000K CRI>80	
□ weiß	133851



133841 100



133850 100



1002890 101

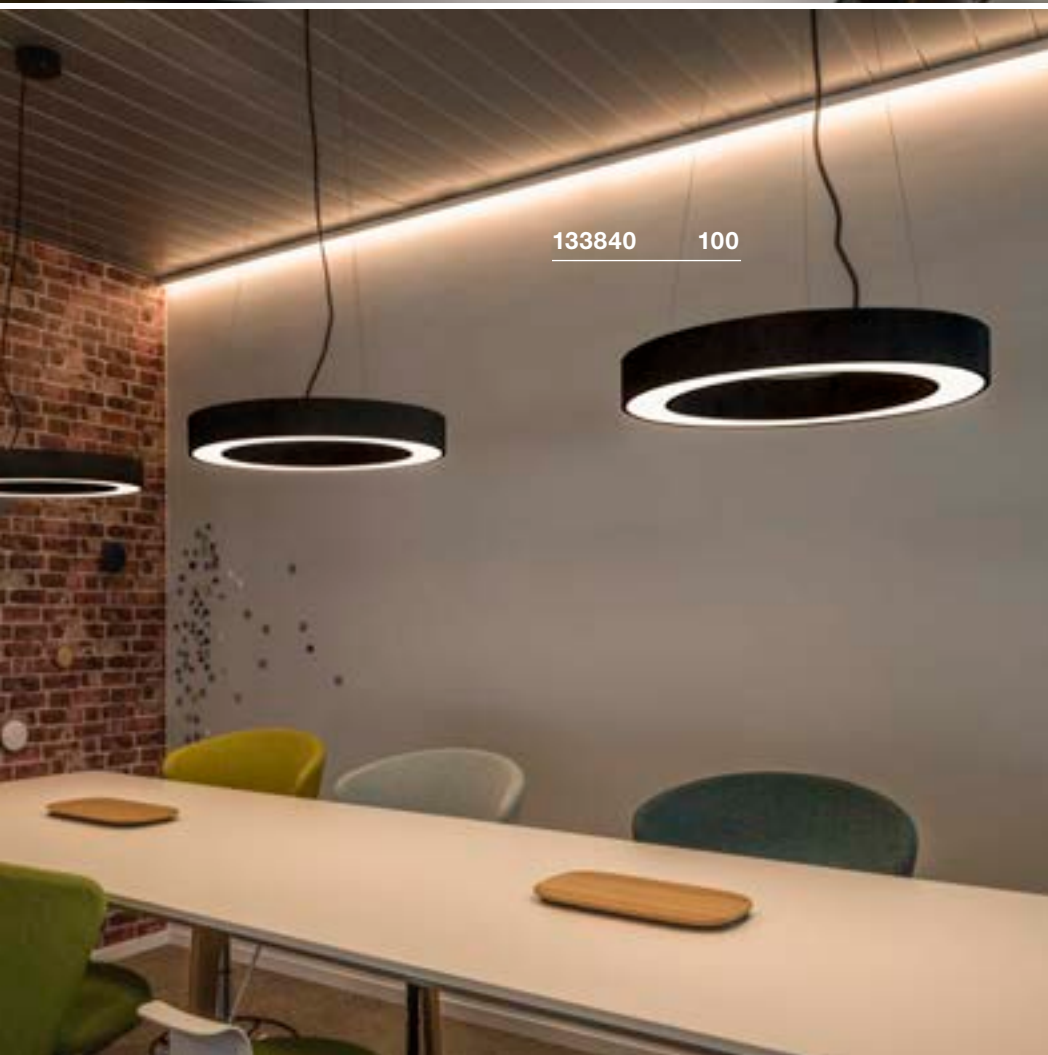

133840 100

MEDO RING 60
PD, DALI

891

A-A++ Spektrum A++-E

LED INSIDE

NEW VARIANT



- Höhe einstellbar

Produktangaben

220-240V ~50/60Hz | 700mA
Systemleistung: 34W
Material: Aluminium / Polymethylacrylat (PMMA)
Dimmbar: Dali

150 20000 105° 4,1 UGR 22

Maßzeichnung

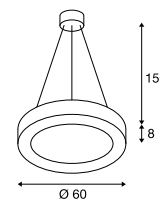

Variante	Art. Nr.
2000lm 3000K CRI>80	
■ schwarz	1002890
2095lm 3000K CRI>80	
□ weiß	1002891

1002913 103



1002913 103

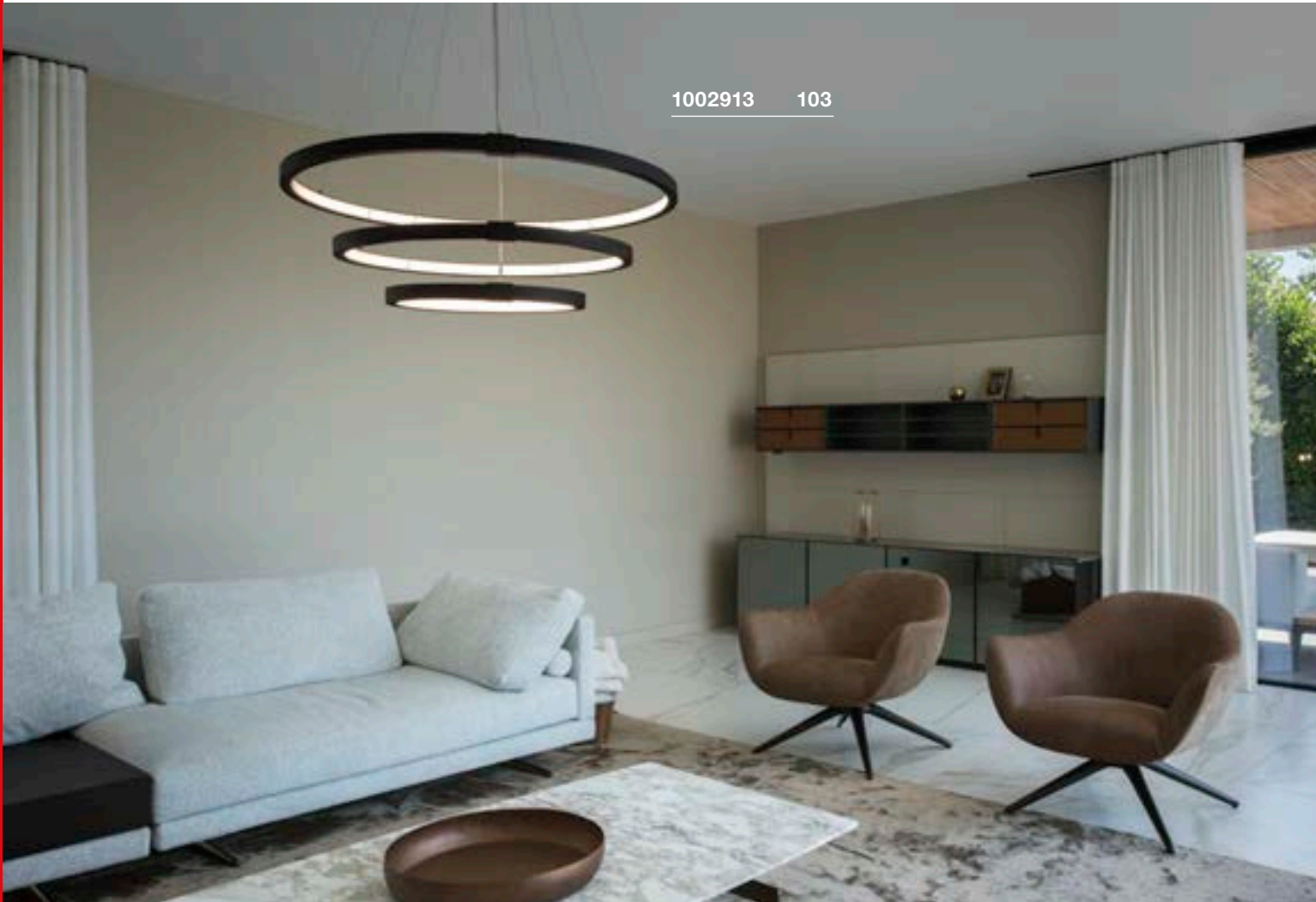

ONE TRIPLE
PD, DALI

892

A-A++ Spektrum A++-E

LED INSIDE

NEW



- Höhe einstellbar
- Lichtfarbe schaltbar

Produktangaben

220-240V 0/~50/60Hz | 1700mA
Systemleistung: 65W
Material: Aluminium / Stahl
Dimmbar: Dali
Produktmaße: Ø: 80 cm L: 150 cm

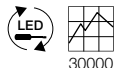
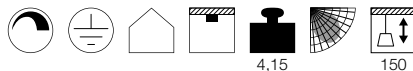

ONE 60
PD, DALI

892

A-A++ Spektrum A++-E

LED INSIDE

NEW

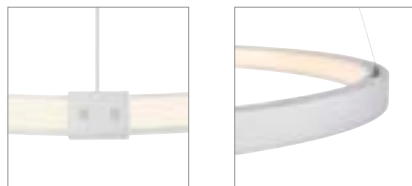

- Höhe einstellbar
- Lichtfarbe schaltbar

Produktangaben

220-240V ~50/60Hz | 600mA
Systemleistung: 25W
Material: Aluminium / Stahl
Dimmbar: Dali
Produktmaße: Ø: 60 cm L: 150 cm

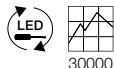
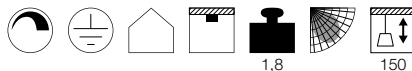

ONE 80
PD, DALI

892

A-A++ Spektrum A++-E

LED INSIDE

NEW

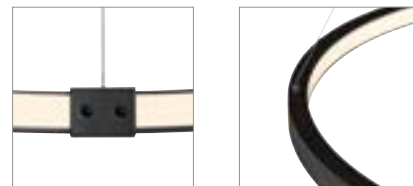

- Höhe einstellbar
- Lichtfarbe schaltbar

Produktangaben

220-240V ~50/60Hz | 800mA
Systemleistung: 35W
Material: Aluminium / Stahl
Dimmbar: Dali
Produktmaße: Ø: 80 cm L: 150 cm

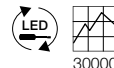
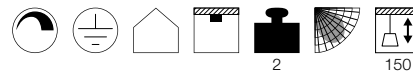

Variante	Art. Nr.
3900/4200lm 3000/4000K CRI>80	
■ matt schwarz	1002913
3900/4200lm 3000/4000K CRI>80	
□ matt weiß	1002914

Variante	Art. Nr.
1400/1500lm 3000/4000K CRI>80	
■ matt schwarz	1002909
1400/1500lm 3000/4000K CRI>80	
□ matt weiß	1002910

Variante	Art. Nr.
2000/2200lm 3000/4000K CRI>80	
■ matt schwarz	1002911
2000/2200lm 3000/4000K CRI>80	
□ matt weiß	1002912

PANEL 60 PD, 1-10V



- Höhe einstellbar

Produktangaben

100-240V ~50/60Hz | 1000mA
 Systemleistung: 42W
 Material: Aluminium / Polymethylacrylat (PMMA)
 Dimmbar: 1-10V

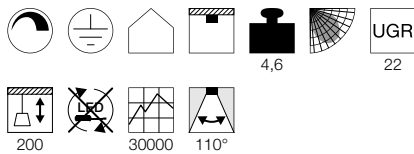

Maßzeichnung

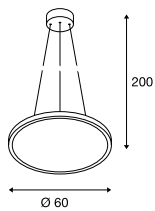

Zubehörempfehlung

1-10V Dimming
 Art. Nr. 470505

Variante	Art. Nr.
2850lm 2700K CRI>80 □ weiß	1001343
3150lm 3000K CRI>80 □ weiß	1001344
3350lm 4000K CRI>80 □ weiß	1001345
2850lm 2700K CRI>80 ■ grau	1001346
3150lm 3000K CRI>80 ■ grau	1001347
3350lm 4000K CRI>80 ■ grau	1001348

1001344 104





1003047 105

PANEL 60

PD, Round, DALI

A-A++ Spektrum
A++-E

LED
INSIDE

NEW
VARIANT

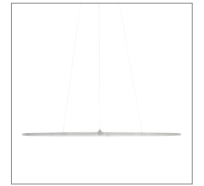

- Höhe einstellbar

Produktangaben

100-277V ~50/60Hz | 1000mA

Systemleistung: 42W

Material: Aluminium / Polymethylacrylat (PMMA)

Dimmbar: Dali

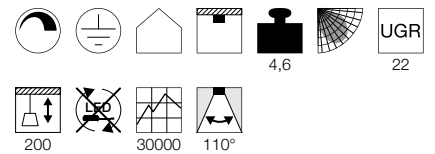

Maßzeichnung

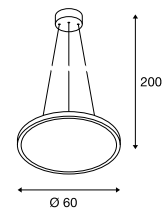

Variante	Art. Nr.
3150lm 3000K CRI>80 □ weiß	1003044
3350lm 4000K CRI>80 □ weiß	1003045
3150lm 3000K CRI>80 ■ grau	1003046
3350lm 4000K CRI>80 ■ grau	1003047

1001447 107

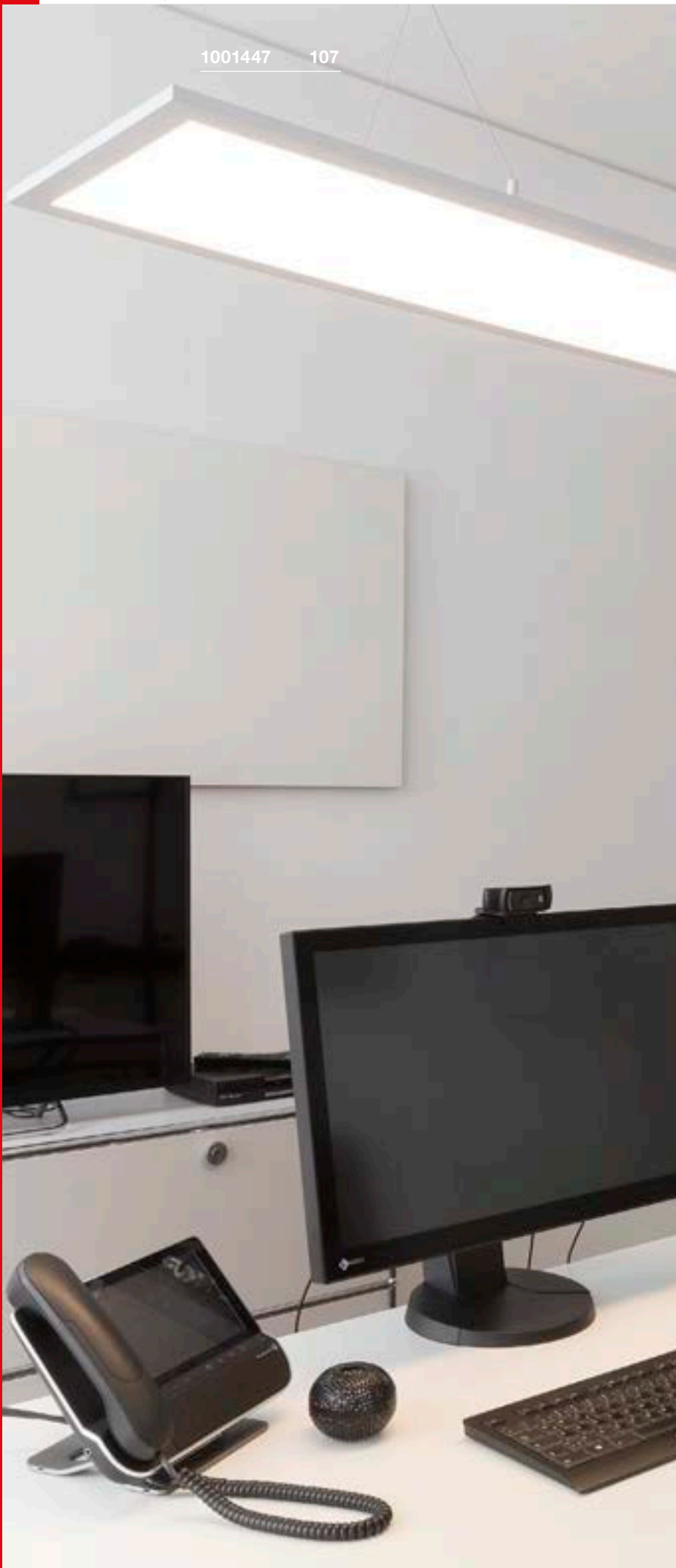

I-PENDANT PRO
PD, 1195x295mm, UGR<22, 1-10V

A-A++ Spektrum
A++-E

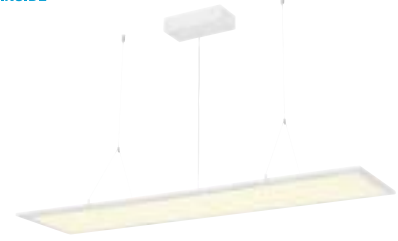

- UGR <22
- Höhe einstellbar

Produktangaben

100-240V ~50/60Hz | 1000mA
Systemleistung: 42W
Material: Aluminium / Acryl
Dimmbar: 1-10V

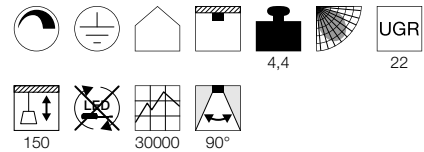

Maßzeichnung

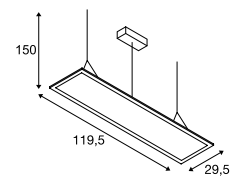

Zubehörempfehlung

1-10V Dimming
Art. Nr. 470505

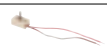

Variante	Art. Nr.
3300lm 3000K CRI>80	
<input type="checkbox"/> weiß	158853
3600lm 4000K CRI>80	
<input type="checkbox"/> weiß	158854

I-PENDANT PRO
PD, 1195x295mm, 1-10V

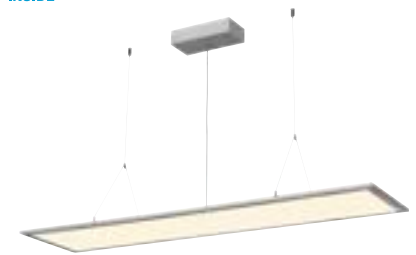

- Höhe einstellbar

Produktangaben

100-240V ~50/60Hz | 1000mA
Systemleistung: 42W
Material: Aluminium / Acryl
Dimmbar: 1-10V

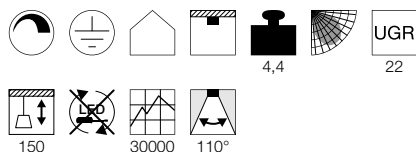

Maßzeichnung

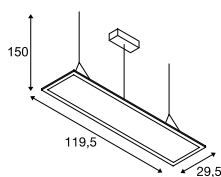

Zubehörempfehlung

1-10V Dimming
Art. Nr. 470505

Variante	Art. Nr.
3100lm 3000K CRI>80 <input type="checkbox"/> matt weiß	158723
3550lm 4000K CRI>80 <input type="checkbox"/> matt weiß	158724
3100lm 3000K CRI>80 <input checked="" type="checkbox"/> grau	158733
3550lm 4000K CRI>80 <input checked="" type="checkbox"/> grau	158734

I-PENDANT PRO
PD, 1195x295mm, UGR<19, 1-10V



- Höhe einstellbar
- Blendreduzierung durch UGR <19
- Bildschirmarbeitsplatz tauglich

Produktangaben

100-240V ~50/60Hz | 1000mA
Systemleistung: 42W
Material: Aluminium / Polymethylacrylat (PMMA)
Dimmbar: 1-10V

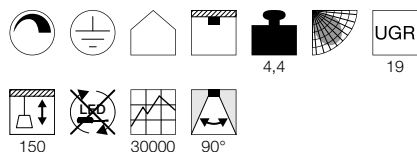

Maßzeichnung

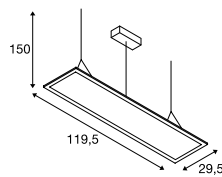

Zubehörempfehlung

1-10V Dimming
Art. Nr. 470505

Variante	Art. Nr.
3750lm 3000K CRI>80 <input type="checkbox"/> weiß	1001447
3800lm 4000K CRI>80 <input type="checkbox"/> weiß	1001448
3750lm 3000K CRI>80 <input checked="" type="checkbox"/> grau	1001647
3800lm 4000K CRI>80 <input checked="" type="checkbox"/> grau	1001648

I-PENDANT PRO
PD, 1195x295mm, DALI

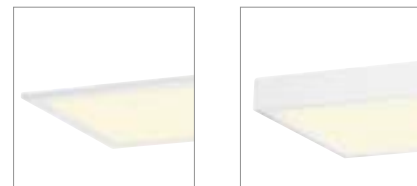
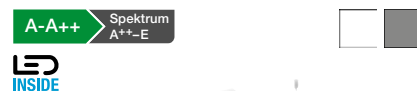

- Höhe einstellbar
- Bildschirmarbeitsplatzgerecht gemäß EN 12464-1
- UGR<19

Produktangaben

100-277V ~50/60Hz | 1000mA
Systemleistung: 42W
Material: Aluminium / Polymethylacrylat (PMMA)
Dimmbar: Dali

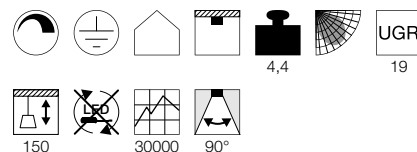

Maßzeichnung

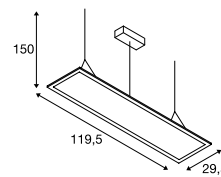

Zubehörempfehlung

1-10V Dimming
Art. Nr. 470505

Variante	Art. Nr.
3750lm 3000K CRI>80 <input type="checkbox"/> weiß	1003048
3800lm 4000K CRI>80 <input type="checkbox"/> weiß	1003049
3750lm 3000K CRI>80 <input checked="" type="checkbox"/> grau	1003050
3800lm 4000K CRI>80 <input checked="" type="checkbox"/> grau	1003051

HANG UP 120
PD, TRIAC

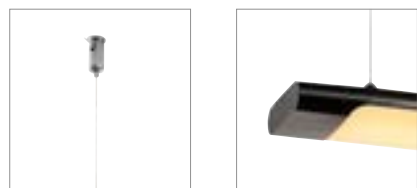

• Höhe einstellbar

Produktangaben

220-240V ~50/60Hz | 250mA
Systemleistung: 41W
Material: Aluminium / Kunststoff
Dimmbar: Triac C

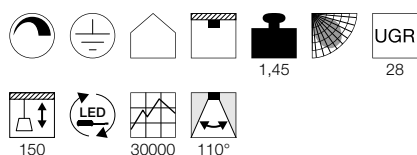

Maßzeichnung

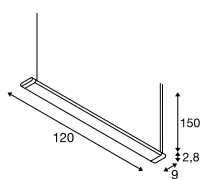

Hinweis

Rosette exkl.
Offenes Kabelend

Zubehöreffahrung

- Deckenrosette
Art. Nr. 210060
- Deckenrosette
Art. Nr. 210061
- Deckenrosette
Art. Nr. 210064

Variante	Art. Nr.
4000lm 3000K CRI>80	
<input checked="" type="checkbox"/> schwarz	160900
4000lm 3000K CRI>80	
<input type="checkbox"/> weiß	160901
4000lm 3000K CRI>80	
<input checked="" type="checkbox"/> grau	160904

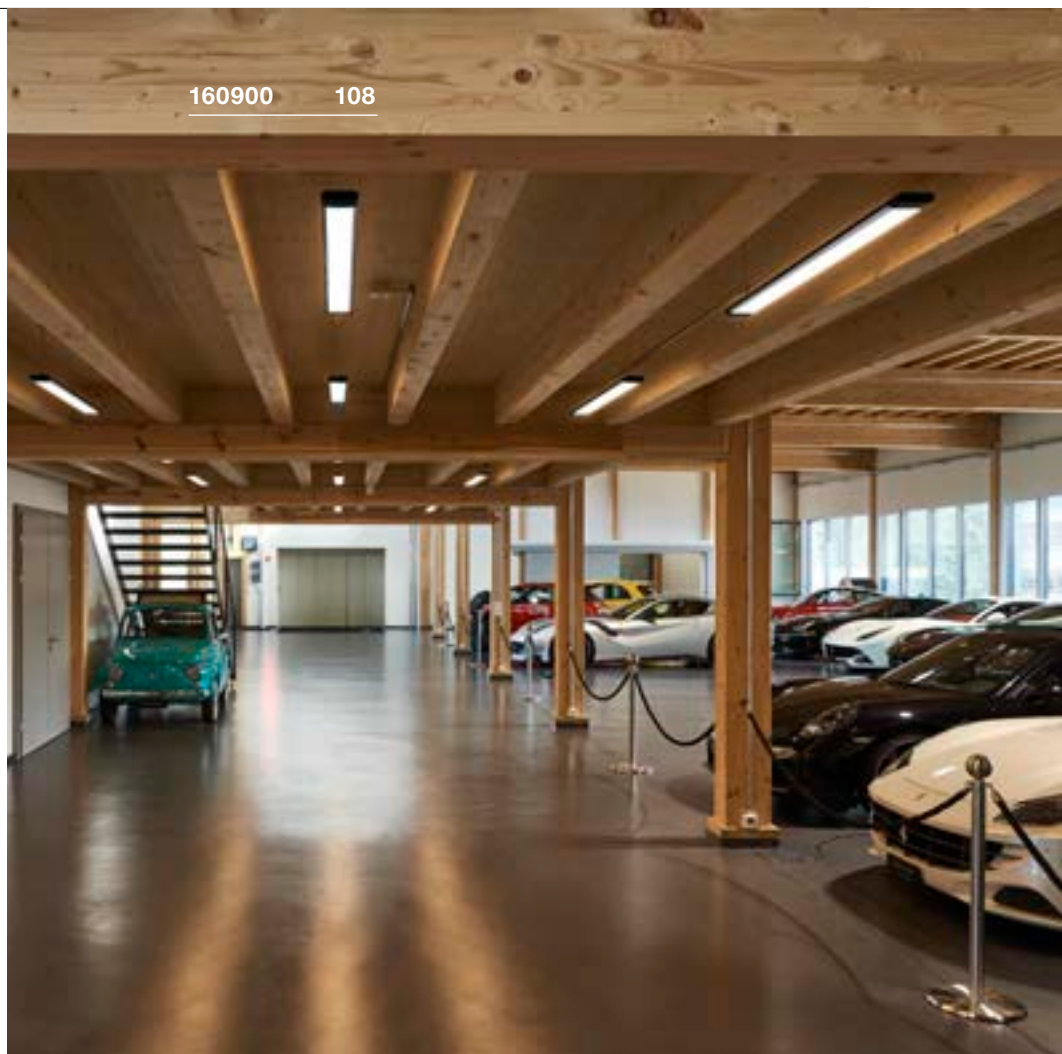



160904

108



LEUCHTEN HIGHLIGHTS.

UNSER PERFEKTES LICHT FÜR IHREN ARBEITSPLATZ.

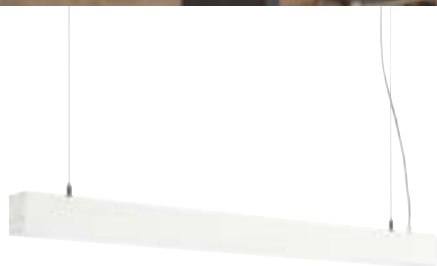
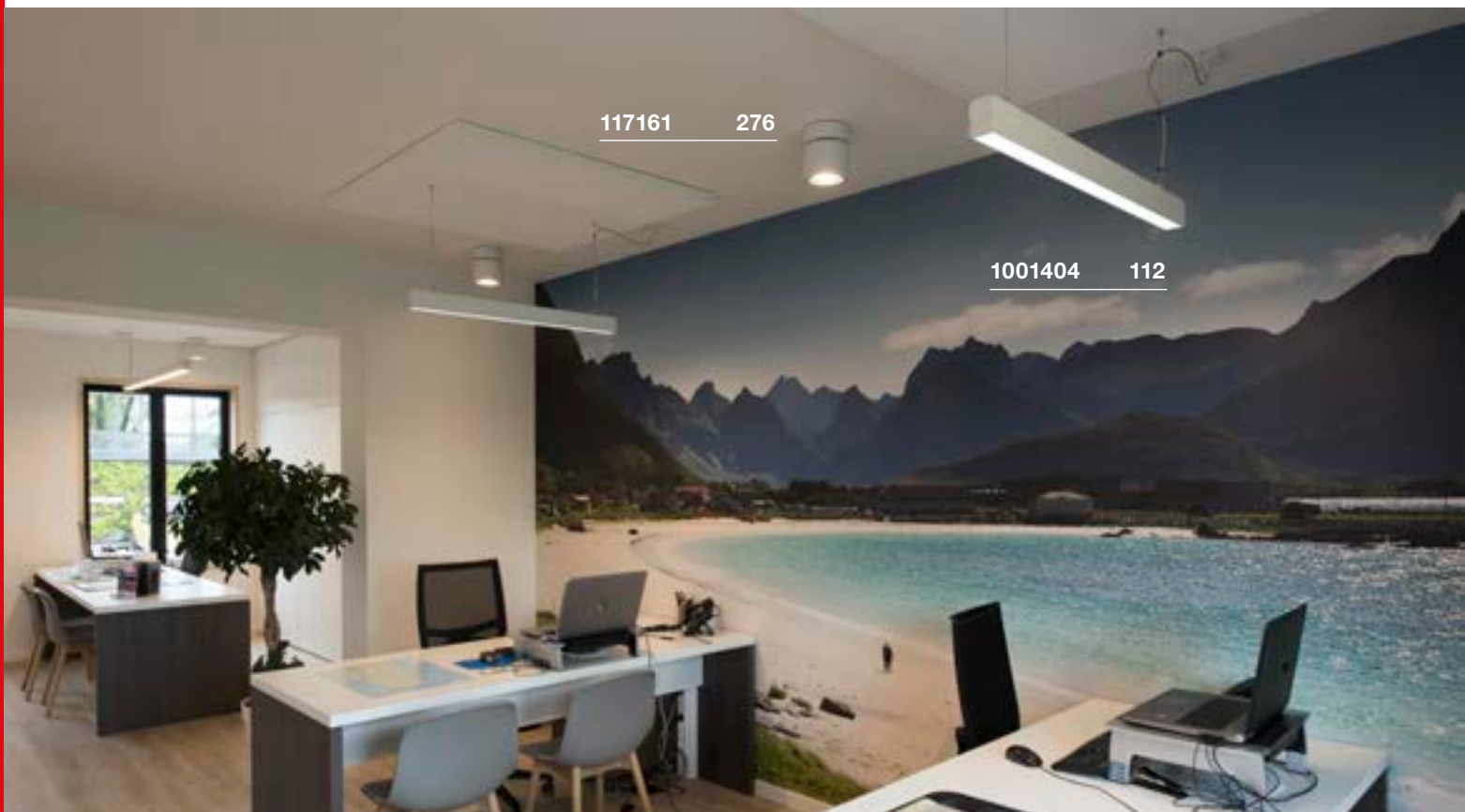

GLENOS® 1m | 2m | 112

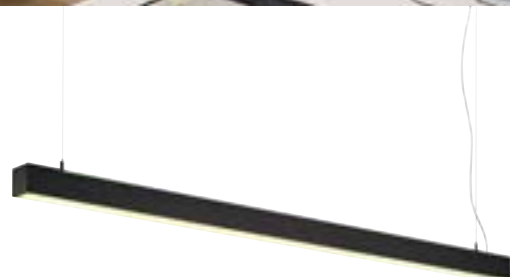

Q-LINE® PD, single | 113



Q-LINE® PD, DALI single | 113



1001306 113

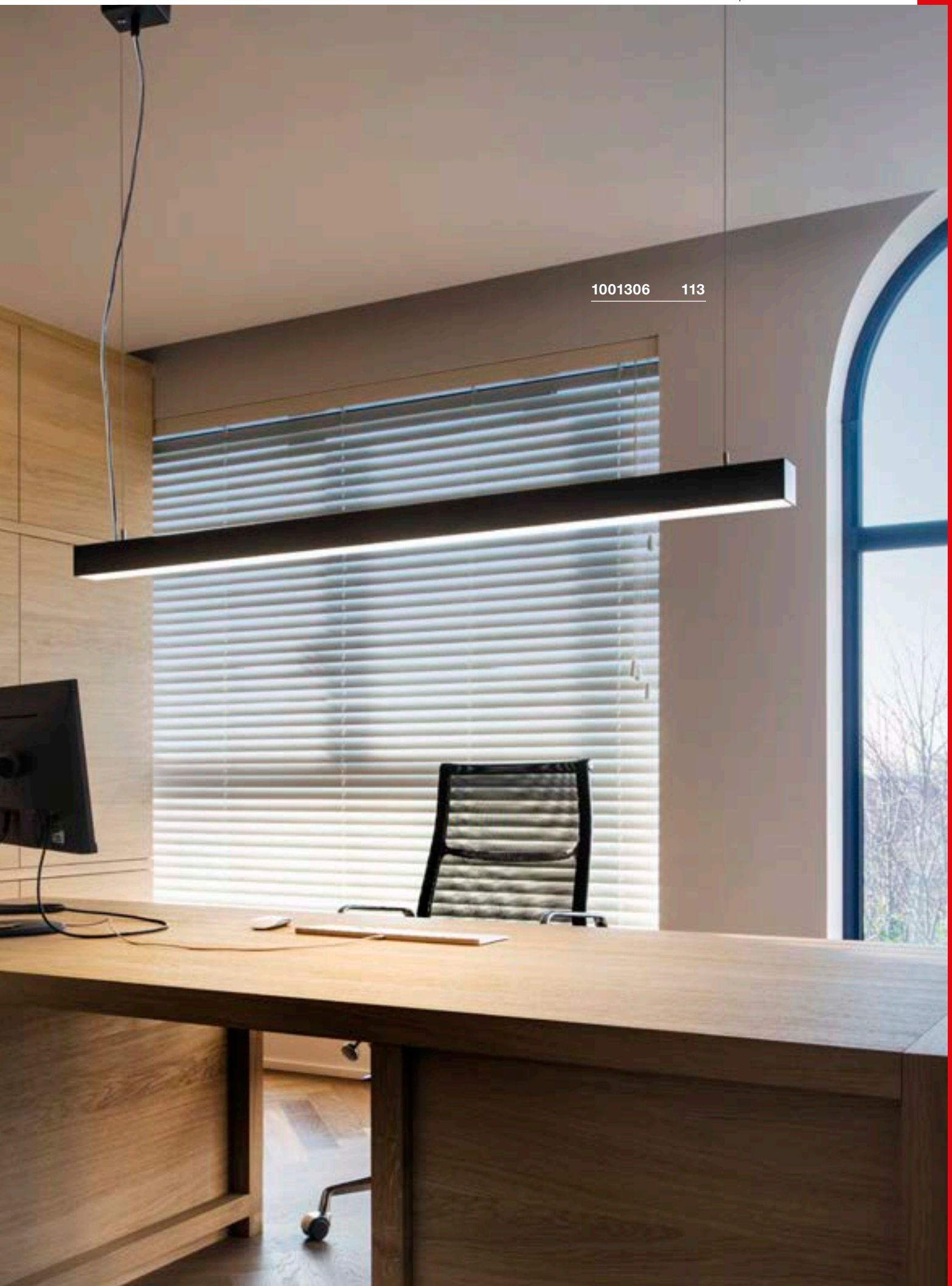

GLENOS
PD, 1m, 1-10V

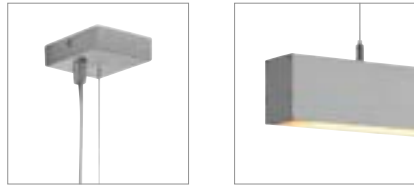

GLENOS
PD, 2m, 1-10V



Produktangaben

220-240V ~50/60Hz | 1000mA
Systemleistung: 43W
Material: Aluminium / Kunststoff
Dimmbar: 1-10V

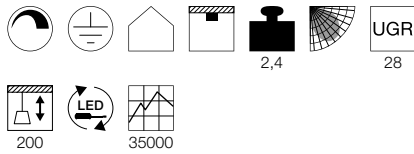

Maßzeichnung

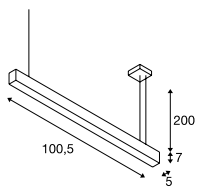

Produktangaben

220-240V ~50/60Hz | 1000mA
Systemleistung: 85W
Material: Aluminium / Kunststoff
Dimmbar: 1-10V

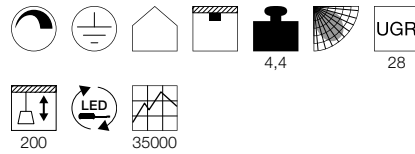

Maßzeichnung

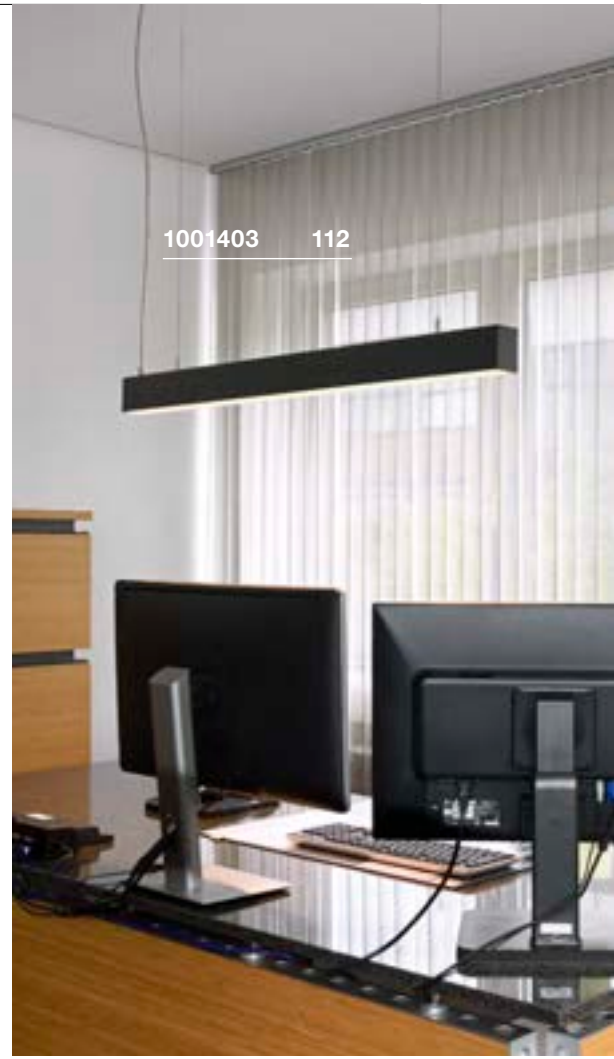
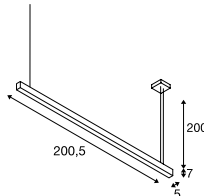

1001403 112



1001403 112

Variante	Art. Nr.
2850lm 3000K CRI>80 ■ matt schwarz	1001400
2850lm 3000K CRI>80 □ matt weiß	1001401
2850lm 3000K CRI>80 ■ silber	1001402
3300lm 4000K CRI>80 ■ matt schwarz	1001403
3300lm 4000K CRI>80 □ matt weiß	1001404
3300lm 4000K CRI>80 ■ silber	1001405

Variante	Art. Nr.
5700lm 3000K CRI>80 ■ matt schwarz	1001406
5700lm 3000K CRI>80 □ matt weiß	1001407
5700lm 3000K CRI>80 ■ silber	1001408
6600lm 4000K CRI>80 ■ matt schwarz	1001409
6600lm 4000K CRI>80 □ matt weiß	1001410
6600lm 4000K CRI>80 ■ silber	1001411

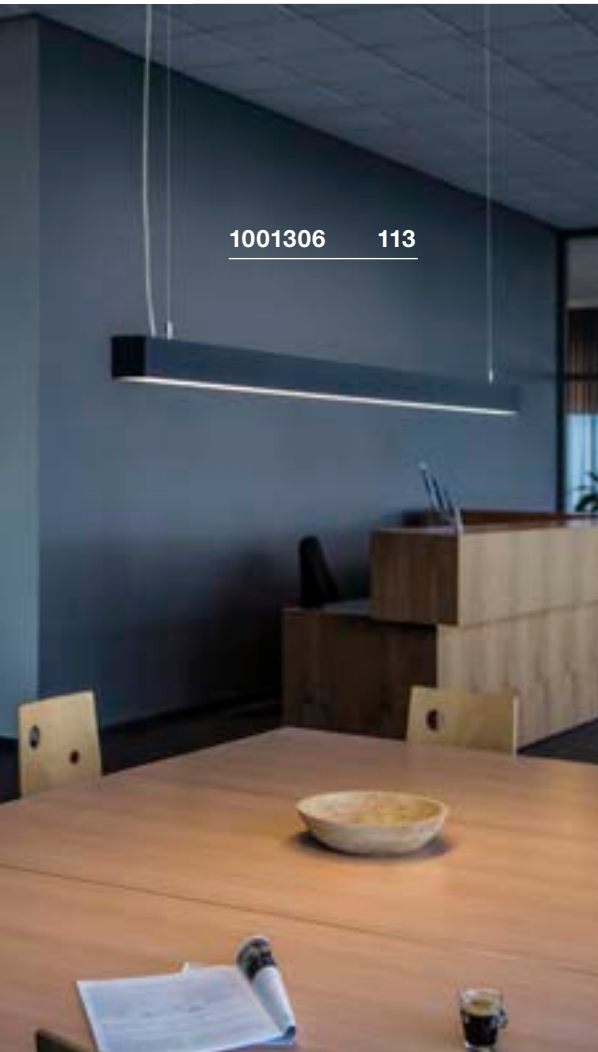

1001306 113



Q-LINE®
PD, single



A-A++ Spektrum
A++-E



- Höhe einstellbar

Produktangaben

220-240V ~50/60Hz | 700mA
Systemleistung: 45,8W
Material: Aluminium / Acryl

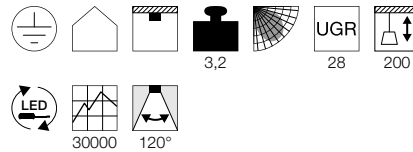

Maßzeichnung

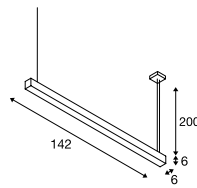

Q-LINE®
PD, DALI, single



A-A++ Spektrum
A++-E



LED
INSIDE



- Höhe einstellbar

Produktangaben

220-240V ~50/60Hz | 350mA-1050mA
Systemleistung: 47W
Material: Aluminium / Acryl
Dimmbar: Dali, Switch

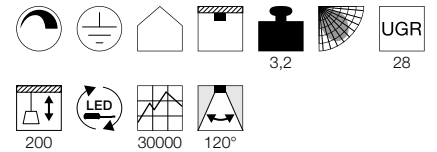

Maßzeichnung

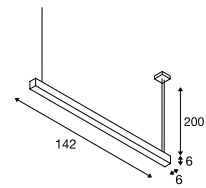

Variante	Art. Nr.
3700lm 3000K CRI>80	
■ schwarz	1001306
□ weiß	1001307
3700lm 3000K CRI>80	
■ grau	1001308

Variante	Art. Nr.
3700lm 3000K CRI>80	
■ schwarz	1001309
□ weiß	1001310
3700lm 3000K CRI>80	
■ grau	1001312

Q-LINE®
PD, 1m, BAP, TRIAC



A-A++ Spektrum
A++-E



- Premium LED mit CRI>90
- Höhe einstellbar

Produktangaben

220-240V ~50/60Hz | 900mA
Systemleistung: 45W
Material: Aluminium / Kunststoff
Dimmbar: Triac L

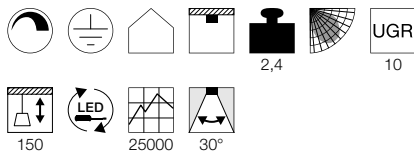

Maßzeichnung

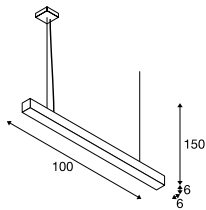

Q-LINE®
PD, 2m, BAP, TRIAC



A-A++ Spektrum
A++-E



- Premium LED mit CRI>90
- Höhe einstellbar

Produktangaben

220-240V ~50/60Hz | 900mA
Systemleistung: 85W
Material: Aluminium / Kunststoff
Dimmbar: Triac L

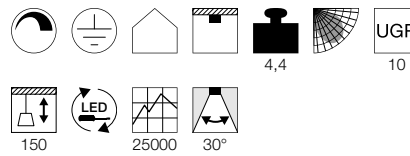

Maßzeichnung

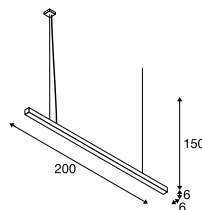

1000926 114



1000934 114

Variante	Art. Nr.
2100lm 3000K CRI>90 ■ weiß	1000926
2100lm 3000K CRI>90 ■ schwarz	1000927
2100lm 3000K CRI>90 ■ grau	1000928
2300lm 4000K CRI>90 ■ weiß	1000932
2300lm 4000K CRI>90 ■ schwarz	1000933
2300lm 4000K CRI>90 ■ grau	1000934

Variante	Art. Nr.
4200lm 3000K CRI>90 ■ weiß	1000929
4200lm 3000K CRI>90 ■ schwarz	1000930
4200lm 3000K CRI>90 ■ grau	1000931
4600lm 4000K CRI>90 ■ weiß	1000935
4600lm 4000K CRI>90 ■ schwarz	1000936
4600lm 4000K CRI>90 ■ grau	1000937

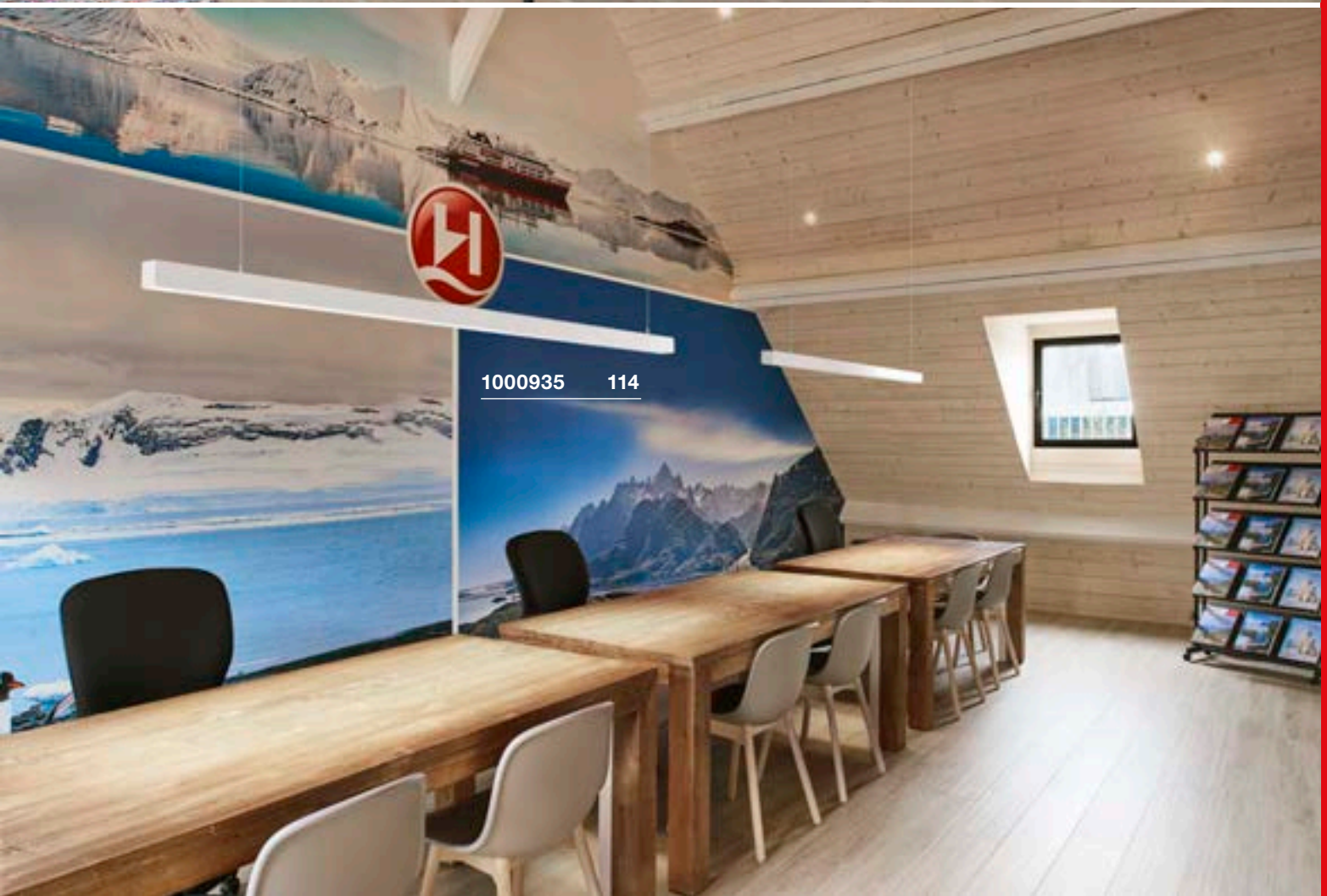
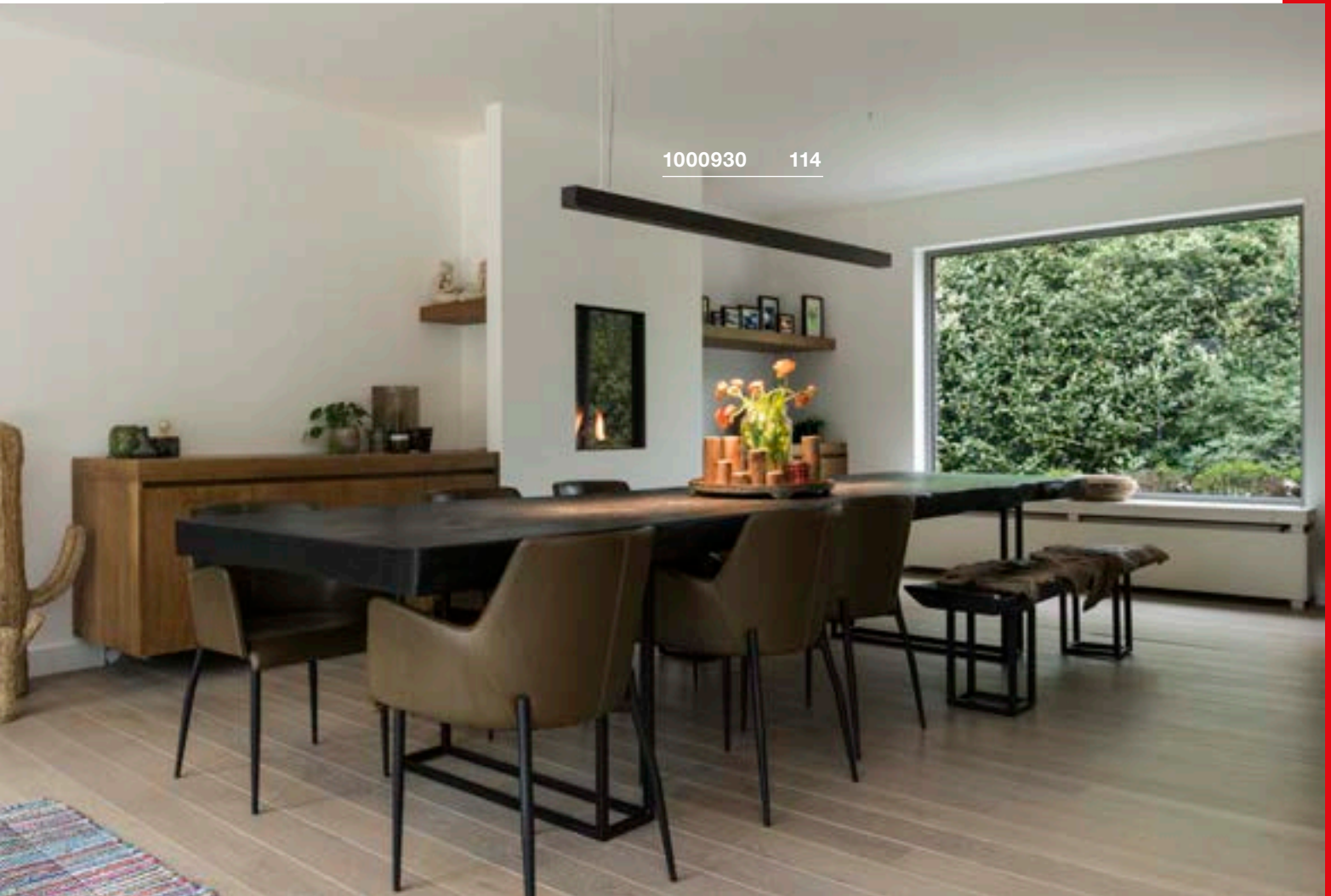

OPEN GRILL
PD, Single Twist



A-A++ Spektrum
A++-E

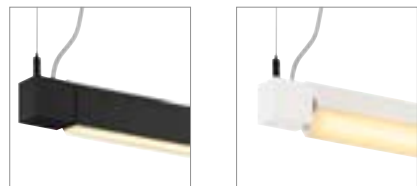

• Höhe einstellbar

Produktangaben

220-240V ~50/60Hz | 700mA
Systemleistung: 38W
Material: Aluminium / Acryl

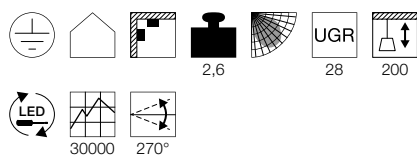

Maßzeichnung

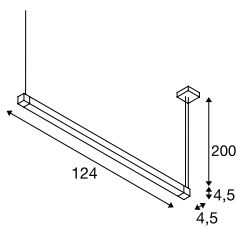

OPEN GRILL
PD, Double Twist



A-A++ Spektrum
A++-E

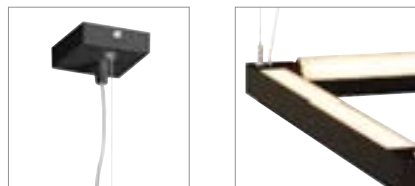

• Höhe einstellbar

Produktangaben

220-240V ~50/60Hz | 1050mA
Systemleistung: 54W
Material: Aluminium / Acryl

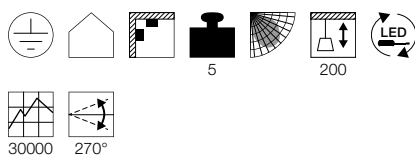

Maßzeichnung

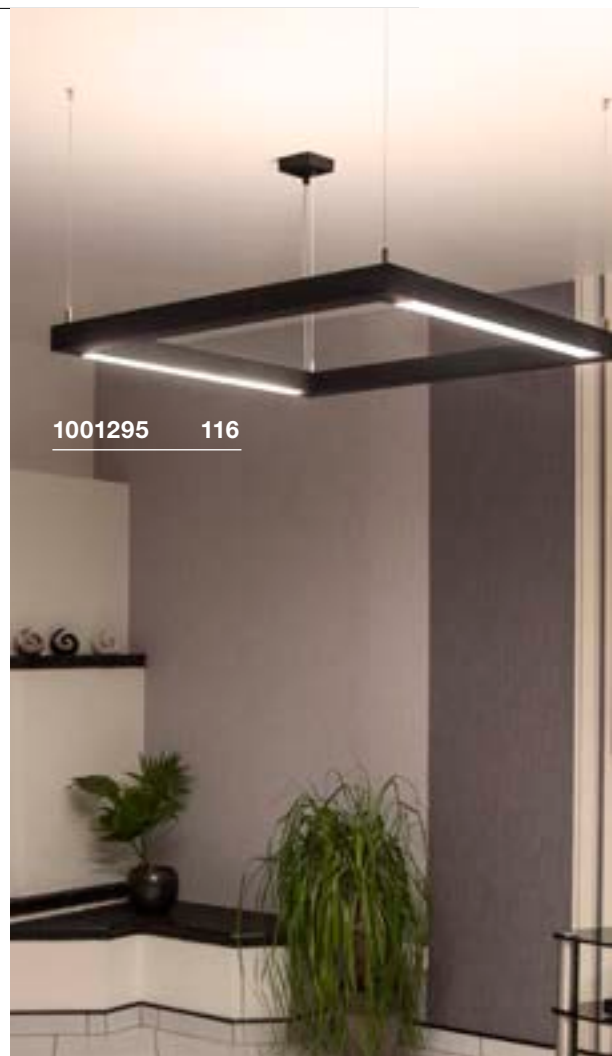
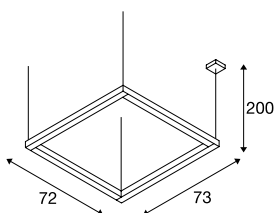

1001295 116

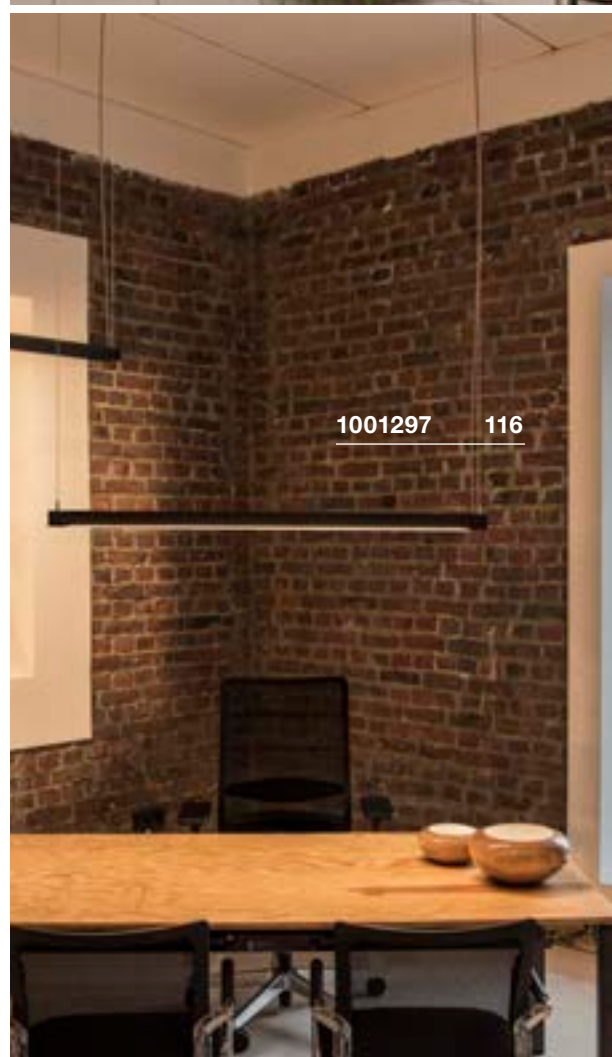

1001297 116

Variante	Art. Nr.
3160lm 3000K CRI>80	
■ schwarz	1001297
2500lm 3000K CRI>80	
□ weiß	157671

Variante	Art. Nr.
4500lm 3000K CRI>80	
■ schwarz	1001295
4500lm 3000K CRI>80	
□ weiß	1001296

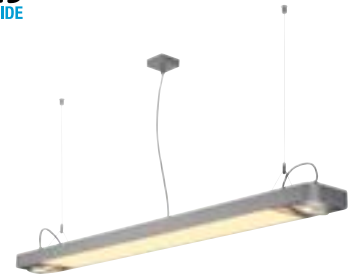

159140 117

AIXLIGHT® 150
PD, R2 Office, TR C 883E-A++ Spektrum
A++-ELED
INSIDE

Produktangaben

220-240V ~50/60Hz | 700mA
Systemleistung: 35W
Material: Aluminium / Stahl
Dimmbar: Triac C, Triac L

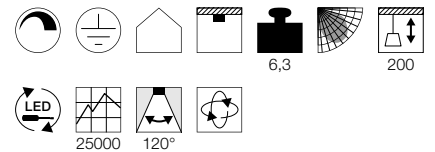

Maßzeichnung

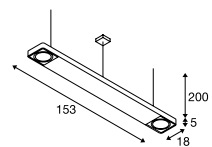

Leuchtmittelpfhlung

GU10 7,9W 40°
4000K 760lm EEK=A+
8kWh/1000h
Art. Nr. 560734



LED GU10 13W 140°
4000K 1100lm EEK=A+
13kWh/1000h
Art. Nr. 1001245



Leuchtmittelangaben

2x max. 75W QPAR111

Variante	Art. Nr.
GU10 QPAR111 4100lm 4000K CRI>80	
■ schwarz	159140
GU10 QPAR111 4100lm 4000K CRI>80	
□ weiß	159141
GU10 QPAR111 4100lm 4000K CRI>80	
■ grau / matt transparent	159144

AIXLIGHT®
PD, R2, double, QPAR111

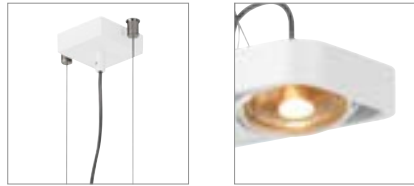

AIXLIGHT®
PD, R2, quad, QPAR111



AIXLIGHT®
PD, R2, quad, QPAR111

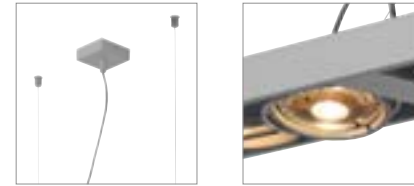

Produktangaben

230V ~50Hz
Material: Aluminium

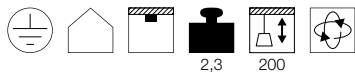

2,3 200

Maßzeichnung

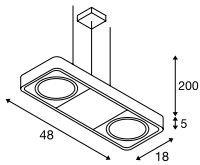

Produktangaben

230V ~50Hz
Material: Aluminium

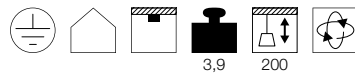

3,9 200

Maßzeichnung

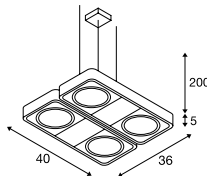

Produktangaben

230V ~50Hz
Material: Aluminium

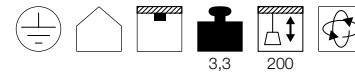

3,3 200

Maßzeichnung

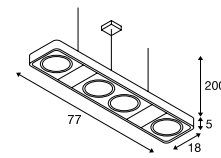

Leuchtmittlempfehlung

LED GU10 17,5W 140°
2700K 750lm EEK=A
18kWh/1000h
Art. Nr. 570532



LED GU10 13W 30°
4000K 1300lm EEK=A+
13kWh/1000h
Art. Nr. 1001243



Leuchtmittlempfehlung

LED GU10 6,5W 38°
2700K 390lm EEK=A+
7kWh/1000h
Art. Nr. 551882



LED GU10 10W 38°
3000K 630lm EEK=A+
10kWh/1000h
Art. Nr. 1001029



Leuchtmittlempfehlung

LED GU10 7W 40°
3000K 730lm EEK=A+
8kWh/1000h
Art. Nr. 1001572



LED GU10 9W 40°
2700-6500K 765lm EEK=A+
9kWh/1000h
Art. Nr. 1001921



Leuchtmittelangaben

2x max. 75W QPAR111

Leuchtmittelangaben

4x max. 75W QPAR111

Leuchtmittelangaben

4x max. 75W QPAR111

Variante	Art. Nr.
GU10 QPAR111	
■ schwarz	159210
GU10 QPAR111	
□ weiß	159211
GU10 QPAR111	
■ grau	159214

Variante	Art. Nr.
GU10 QPAR111	
■ schwarz	159230
GU10 QPAR111	
□ weiß	159231
GU10 QPAR111	
■ grau	159234

Variante	Art. Nr.
GU10 QPAR111	
■ schwarz	159220
GU10 QPAR111	
□ weiß	159221
GU10 QPAR111	
■ grau	159224

WORKLIGHT
PD, DALI



898

A-A++ Spektrum
A++-E



NEW
VARIANT

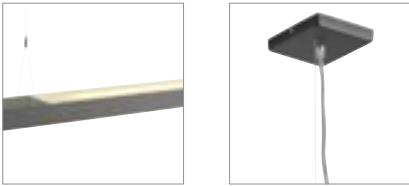
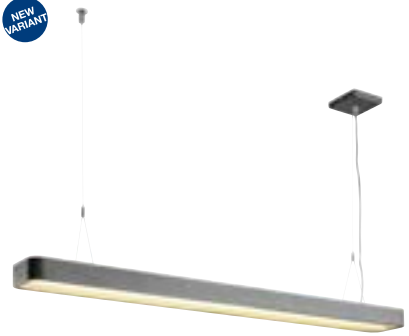

- Höhe einstellbar
- Direktes und indirektes Licht

Produktangaben

220-240V ~50/60Hz | 226mA
Systemleistung: 49W
Material: Aluminium / Acryl
Dimmbar: Dali

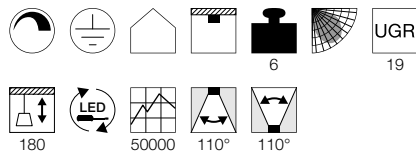

Maßzeichnung

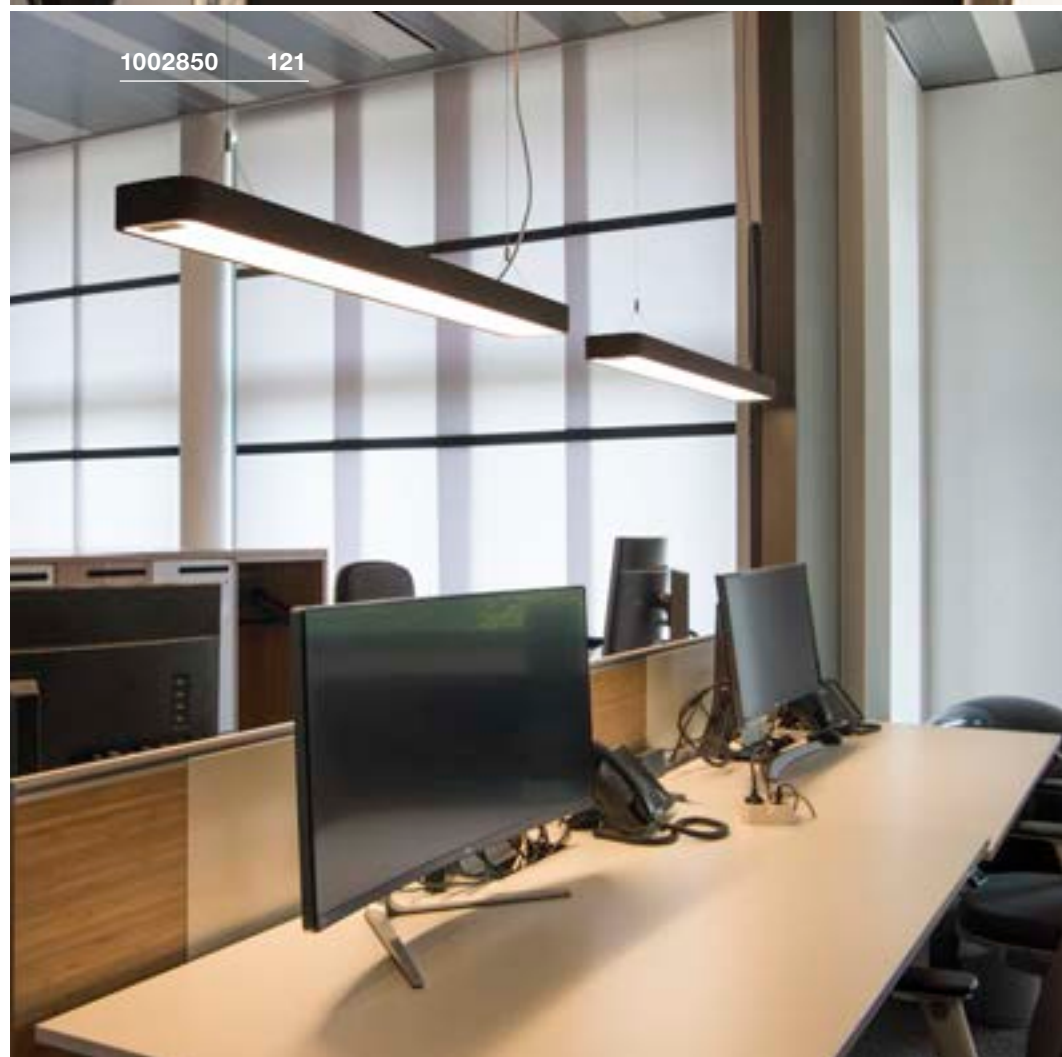
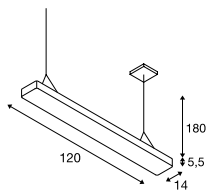

Variante	Art. Nr.
Direkt: 3600lm 3000K CRI>80 Indirekt: 1800lm 3000K CRI>80 □ weiß	1002838
Direkt: 3600lm 3000K CRI>80 Indirekt: 1800lm 3000K CRI>80 ■ anthrazit	1002839

WORKLIGHT PLUS
PD, DALI



- Intelligente Anwesenheitssteuerung und Helligkeitssensorik
- Direktes und indirektes Licht

Produktangaben

220-240V ~50/60Hz | 226mA
Systemleistung: 48W
Material: Aluminium / Acryl
Dimmbar: Dali

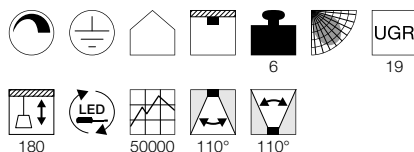

Maßzeichnung

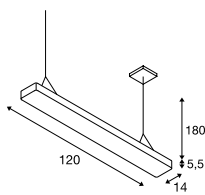

Variante	Art. Nr.
Direkt: 3600lm 3000K CRI>80 Indirekt: 1920lm 3000K CRI>80	1002849
Direkt: 3600lm 3000K CRI>80 Indirekt: 1920lm 3000K CRI>80	1002850



INTELLIGENTE ARBEITSPLATZLEUCHE FÜR DAS MODERNE BÜRO
Energieeffizient und langleb

Unsere WORKLIGHT PLUS PD, DALI Pendelleuchte für Bildschirmarbeitsplätze (UGR ≤19) überzeugt durch klare Formen ausgestattet mit modernster Technik und leistungsstarken LEDs mit einer Lebensdauer von 50.000 Stunden aus dem Hause Philips.
Durch die Ausstattung mit einer intelligenten Lichtsteuerung wird das Energieeinsparpotential optimiert. Dank integrierter Anwesenheitssteuerung schaltet sich das Licht abhängig von einer Bewegung automatisch an und aus und durch den Tageslichtsensor wird der Lichtstrom geregelt. Somit wird ein gleichbleibendes Lichtniveau am Arbeitsplatz sichergestellt.
Weiteres Highlight ist die Fähigkeit das Background Level einzustellen (10%-70% Lichtstrom), welches zusätzlich den Komfort steigert. Die Kombination aus direkte und indirekte Lichtabgabe sorgt für breite und gleichmäßige Ausleuchtung.

Des Weiteren sind Gruppierung der Leuchten und individuelle Einstellung für Großraumbüros mit der IR programmier Fernbedienung möglich (bis zu 50 Leuchten).
Einfaches Nachrüsten mit der WORKLIGHT PLUS PD, DALI Pendelleuchte nach Büroumbau – kein Problem. Dank der Möglichkeit der kabellosen Steuerung und Programmierung (Wireless DALI) kann die mobile Arbeitsplatzleuchte einfach ins Gebäude integriert werden, ohne aufwendiges Verkabeln.
Die Pendelleuchte ist bereits mit Pendelabhängungen und Deckenrosette ausgestattet. Die WORKLIGHT Familie ist eine Produktfamilie und ist als Stehleuchte ebenfalls erhältlich.

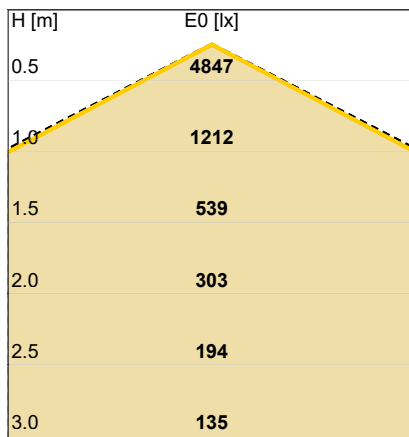

-- C0/C180 (half-peak divergence: 110.4°)
— C90/C270 (half-peak divergence: 109.6°)

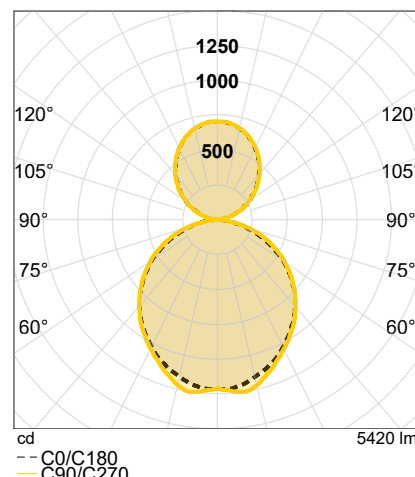

1002196 123

1002193 123

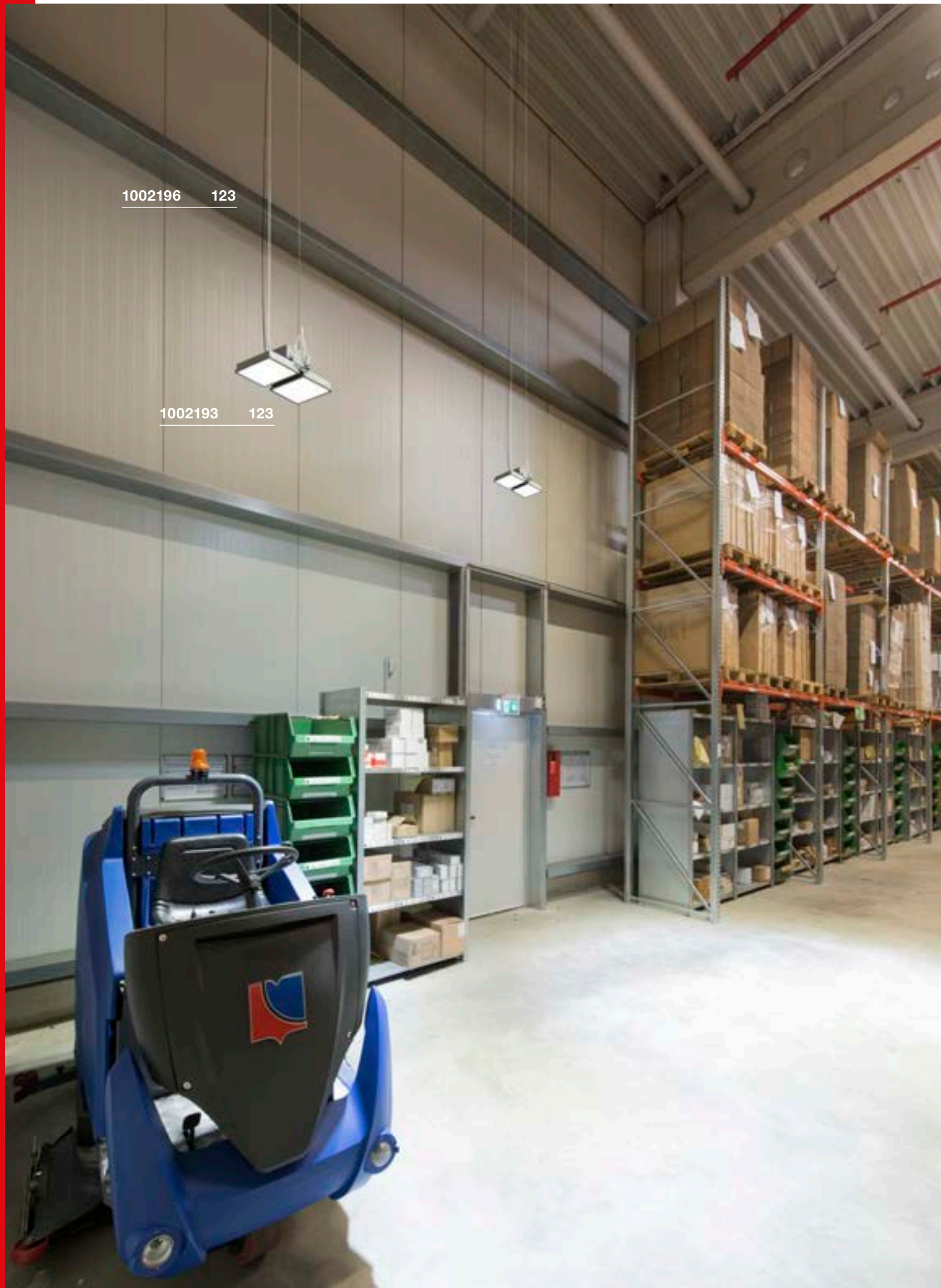



1002193 123

ALMINO
PD, double, UGR<19



A-A++ Spektrum A++-E

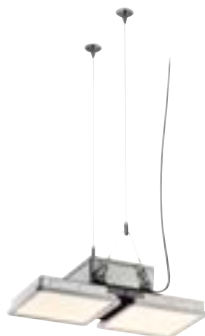

- Besonders gut geeignet für Industriebereiche, Lager- und Logistik
- Effiziente Grundbeleuchtung mit begrenzter Direktblendung, UGR< 19
- Besonders widerstandsfähiges Gehäuse

Produktangaben

220-240V ~50/60Hz | 600mA
Systemleistung: 95W
Material: Stahl / Polycarbonat (PC)

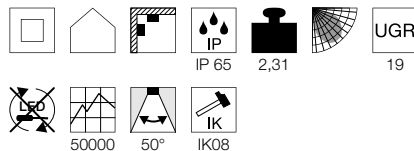

Maßzeichnung

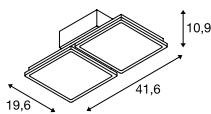

Hinweis

Schwenkbereich (bei Nutzung mit 1002197): 0-180°

Zubehöreffahrung

- Abhängeset 3m
Art. Nr. 1002196
- Montage Bügel
Art. Nr. 1002197



Variante	Art. Nr.
12000lm 4000K CRI>80 ■ grau / weiß	1002193

ALMINO
PD, quad, UGR<19



A-A++ Spektrum A++-E



- Besonders gut geeignet für Industriebereiche, Lager- und Logistik
- Effiziente Grundbeleuchtung mit begrenzter Direktblendung, UGR< 19
- Besonders widerstandsfähiges Gehäuse

Produktangaben

220-240V ~50/60Hz | 1200mA
Systemleistung: 190W
Material: Stahl / Polycarbonat (PC)

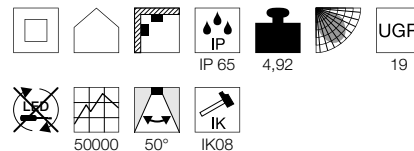

Maßzeichnung

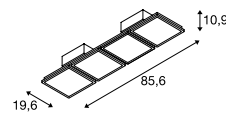

Zubehöreffahrung

- Abhängeset 3m
Art. Nr. 1002196
- Montage Bügel
Art. Nr. 1002197



Variante	Art. Nr.
24000lm 4000K CRI>80 ■ grau / weiß	1002194

SUPROS 78
PD

897

A-A++ Spektrum
A++-E

133121 124

Produktangaben

220-240V ~50/60Hz | 250mA
 Systemleistung: 12W
 Material: Aluminium
 Dimmbar: Triac C, Triac L

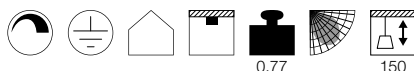

0,77

150

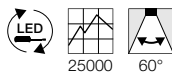

25000 60°

Maßzeichnung

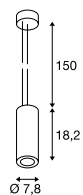

Zubehörimpfehlung

Linse 20°

Art. Nr. 116302



Linse 40°

Art. Nr. 116304



Variante	Art. Nr.
700lm 3000K CRI>80	
■ schwarz	133120
700lm 3000K CRI>80	
□ weiß	133121



133101 125



133100 125

SUPROS PD



A-A++ Spektrum A++-E



Produktangaben

220-240V ~50/60Hz | 750mA
Systemleistung: 31W
Material: Aluminium



1,71

200

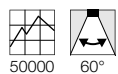

50000 60°

Maßzeichnung

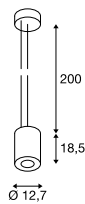

Zubehörempfehlung

Reflek or 20°

Art. Nr. 114102

Reflek or 40°

Art. Nr. 114104



Variante	Art. Nr.
2600lm 3000K CRI>80	
■ schwarz	133100
2600lm 3000K CRI>80	
□ weiß	133101
2850lm 4000K CRI>80	
■ schwarz	133110
2850lm 4000K CRI>80	
□ weiß	133111

SUPROS PD



A-A++ Spektrum A++-E



Produktangaben

220-240V ~50/60Hz | 950mA
Systemleistung: 36W
Material: Aluminium



1,71

200

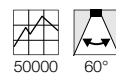

50000 60°

Maßzeichnung

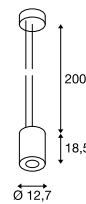

Zubehörempfehlung

Reflek or 20°

Art. Nr. 114102

Reflek or 40°

Art. Nr. 114104



Variante	Art. Nr.
3100lm 3000K CRI>80	
■ schwarz	133140
3100lm 3000K CRI>80	
□ weiß	133141
3300lm 4000K CRI>80	
■ schwarz	133150
3300lm 4000K CRI>80	
□ weiß	133151

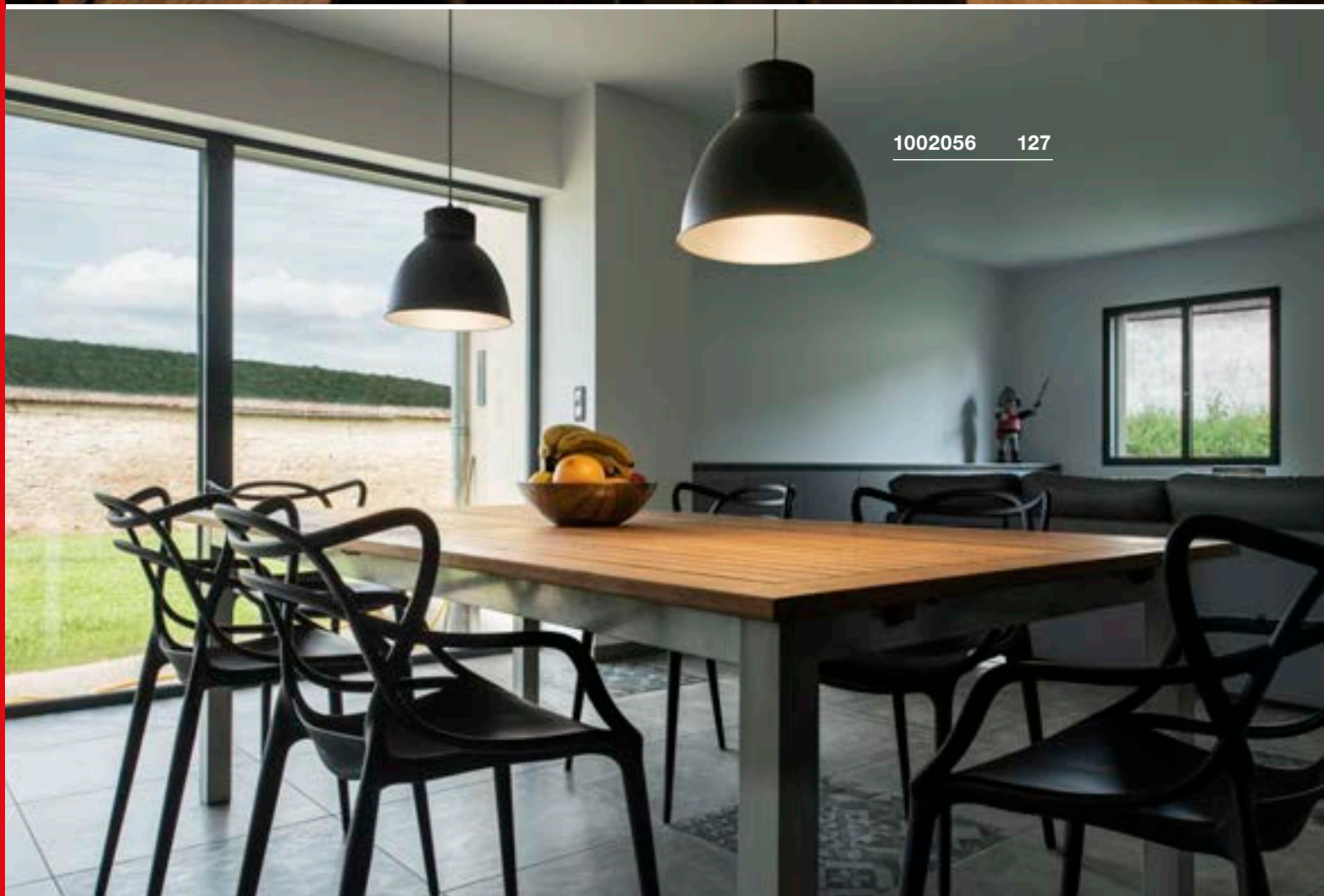

PARA DOME
PD, E27



Produktangaben

230V ~50Hz
Material: Aluminium



Maßzeichnung

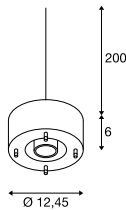

Hinweis

Offenes Kabelend

Leuchtmittlempfehlung

LED E27 14,5W 200°
2700K 1521lm EEK=A+
15kWh/1000h
Art. Nr. 560422



LED E27 17W 45°
3000K 1430lm EEK=A+
17kWh/1000h
Art. Nr. 560473



Leuchtmittelangaben

max. 150W

Variante	Art. Nr.
E27	
■ schwarz	1002053
E27	
□ weiß	1002054
E27	
■ grau	1002055

PARA DOME
E27



Produktangaben

Material: Aluminium
Produktmaße: Ø: 30,8 cm H: 20,6 cm

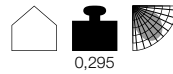

Variante	Art. Nr.
■ schwarz	1002056
□ weiß	1002057
■ grau	1002058

PARA DOME
E27



Produktangaben

Material: Polycarbonat (PC)
Produktmaße: Ø: 31,5 cm H: 20,5 cm



Variante	Art. Nr.
□ transparent	1002059

PARA 380 PD, E27

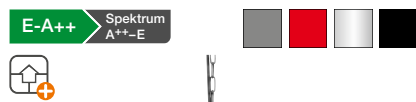

Produktangaben

230V ~50Hz
Material: Aluminium

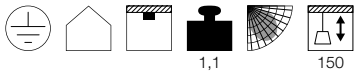

Maßzeichnung

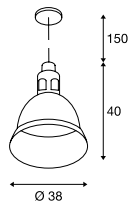

Leuchtmittlempfehlung

LED E27 14,5W 200°
2700K 1521lm EEK=A+
15kWh/1000h
Art. Nr. 560422



LED E27 18,5W 38°
4000K 1280lm EEK=A+
19kWh/1000h
Art. Nr. 551944



Leuchtmittelangaben

160W HME-SB

Variante	Art. Nr.
E27 HME-SB	
■ grau	165350
E27 HME-SB	
■ rot	165356
E27 HME-SB	
■ aluminium	165358
E27 HME-SB	
■ schwarz	165359





PARA DOME
PD, E27

E-A++ Spektrum A++-E



• Weit geöffneter Leuchtschirm

Produktangaben

230V ~50Hz
Material: Aluminium / Polycarbonat (PC)

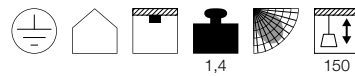

Maßzeichnung

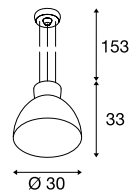

Zubehörempfehlung

Reflek or Abdeckung
Art. Nr. 165160



Leuchtmittlempfehlung

LED E27 14,5W 200°
2700K 1521lm EEK=A+
15kWh/1000h
Art. Nr. 560422



LED E27 15W 240°
3000K 1521lm EEK=A+
15kWh/1000h
Art. Nr. 1001033



Leuchtmittelangaben

max. 150W

Variante	Art. Nr.
E27	
■ anthrazit	165100

PARA MULTI
PD, DLMI

A-A++ Spektrum A++-E



Produktangaben

220-240V ~50/60Hz
Systemleistung: 18W
Material: Stahl / Acryl

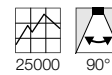
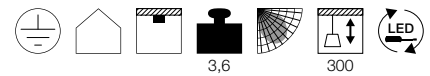

Maßzeichnung

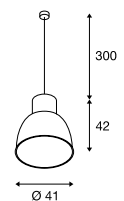

Variante	Art. Nr.
2040lm 4000K CRI>80	
■ grau / matt transparent	165221
1940lm 3000K CRI>80	
■ grau / matt transparent	165222

PARA FLAC
PD/CL

A-A++ Spektrum
A++-E



• Hohe Lichtausbeute: >100lm/W

Produktangaben

220-240V ~50/60Hz | 2400mA
Material: Aluminium / Polycarbonat (PC)

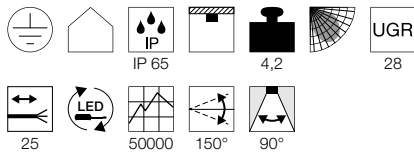

Maßzeichnung

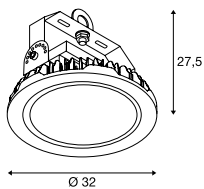

Hinweis

Produkt wird ohne Kette geliefert und kann mit handelsüblichen Ketten abgehängt werden
Offenes Kabelend

Zubehörepfehlung

- Verbindungsbox IP68, 3-polig
Art. Nr. 228730
- Reflekt or
Art. Nr. 1000918
- Refraktor
Art. Nr. 1001691
- Refraktor Abdeckung
Art. Nr. 1001692



Variante	Art. Nr.
12800lm 4000K CRI>80 104W	
■ schwarz	1000827
19200lm 4000K CRI>80 150W	
■ schwarz	1000828



1000828 + 1000918 130



1003107 + 1001691 + 1001692 131

PARA FLAC PD/CL, DALI

A-A++ Spektrum
A++-E

LED
INSIDE

NEW
VARIANT



Produktangaben

220-240V ~50/60Hz | 1600mA

Systemleistung: 104W

Material: Aluminium / Polycarbonat (PC)

Dimmbar: Dali

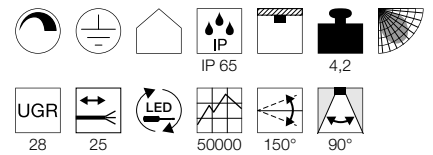

Maßzeichnung

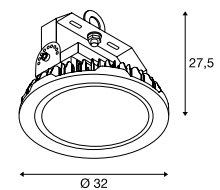

Hinweis

Produkt wird ohne Kette geliefert und kann mit handelsüblichen Ketten abgehängt werden
Offenes Kabelend

Zubehörempfehlung

■ Verbindungsbox IP68, 3-polig

Art. Nr. 228730

■ Reflek or

Art. Nr. 1000918

□ Refraktor

Art. Nr. 1001691

□ Refraktor Abdeckung

Art. Nr. 1001692

Variante

Art. Nr.

12800lm | 4000K | CRI>80

■ schwarz

1003107

ÜBERRASCHEND WANDELBAR.

WANDLEUCHTEN BRINGEN
INDIVIDUELLE LICHTSPOTS.

Ein Blickfang für die Wand – ein echtes Highlight für den Raum: Wandleuchten sind eine ideale Möglichkeit, um platzsparend Lichtspots zu setzen. Und bei der großen Auswahl an Designs und Farben ist für jeden Geschmack etwas Passendes dabei.





1002928 157



1003035 + 1001453 193 + 192



WANDLEUCHTEN

 137	 137	 139	 139	 140	 140	 142	 143
 144	 145	 145	 145	 146	 147	 148	 148
 149	 149	 150	 151	 151	 152	 153	 153
 153	 154	 155	 155	 156	 156	 157	 157
 158	 158	 159	 159	 161	 162	 162	 163
 163	 164	 164	 164	 166	 167	 167	 167
 168	 168	 169	 169	 170	 171	 171	 171

 172	 172	 173	 173	 174	 174	 175	 175
 176	 176	 178	 178	 179	 180	 180	 180
 183	 183	 183	 184	 184	 185	 186	 186
 188	 189	 190	 191	 192	 192	 193	 194
 194	 194	 195	 196	 197	 198	 199	 199
 199	 200	 200	 202	 202	 202	 204	 204
 205	 206	 206	 208	 208	 210	 210	 211
 211	 212	 212	 213	 213	 214	 215	 215
 216	 216	 219	 220	 220	 221	 223	 223
 223	 224	 224	 225	 225	 227	 227	 228
 228	 229						

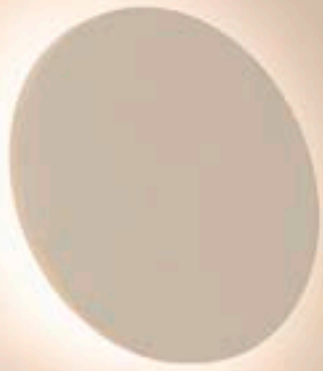

148091 137





148091 137



148019 137

PLASTRA WL

893

A-A++ Spektrum A++-E



- Individuell gestaltbar mit Farben, Stickern & mehr

Produktangaben

100-240V ~50/60Hz | 12V DC
Systemleistung: 7,4W
Material: Gips / Stahl



Maßzeichnung

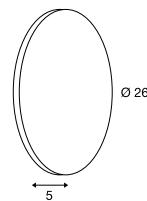

PLASTRA WL, Square

893

A-A++ Spektrum A++-E



- Individuell gestaltbar mit Farben, Stickern & mehr

Produktangaben

100-240V ~50/60Hz | 12V DC
Systemleistung: 11W
Material: Gips / Stahl

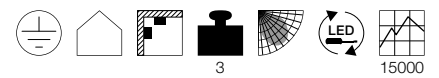

Maßzeichnung

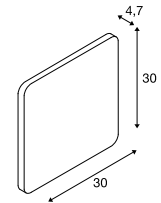

Variante	Art. Nr.
400lm 3000K CRI>80 □ weiß	148091

Variante	Art. Nr.
400lm 3000K CRI>80 □ weiß	148019

1000746 139

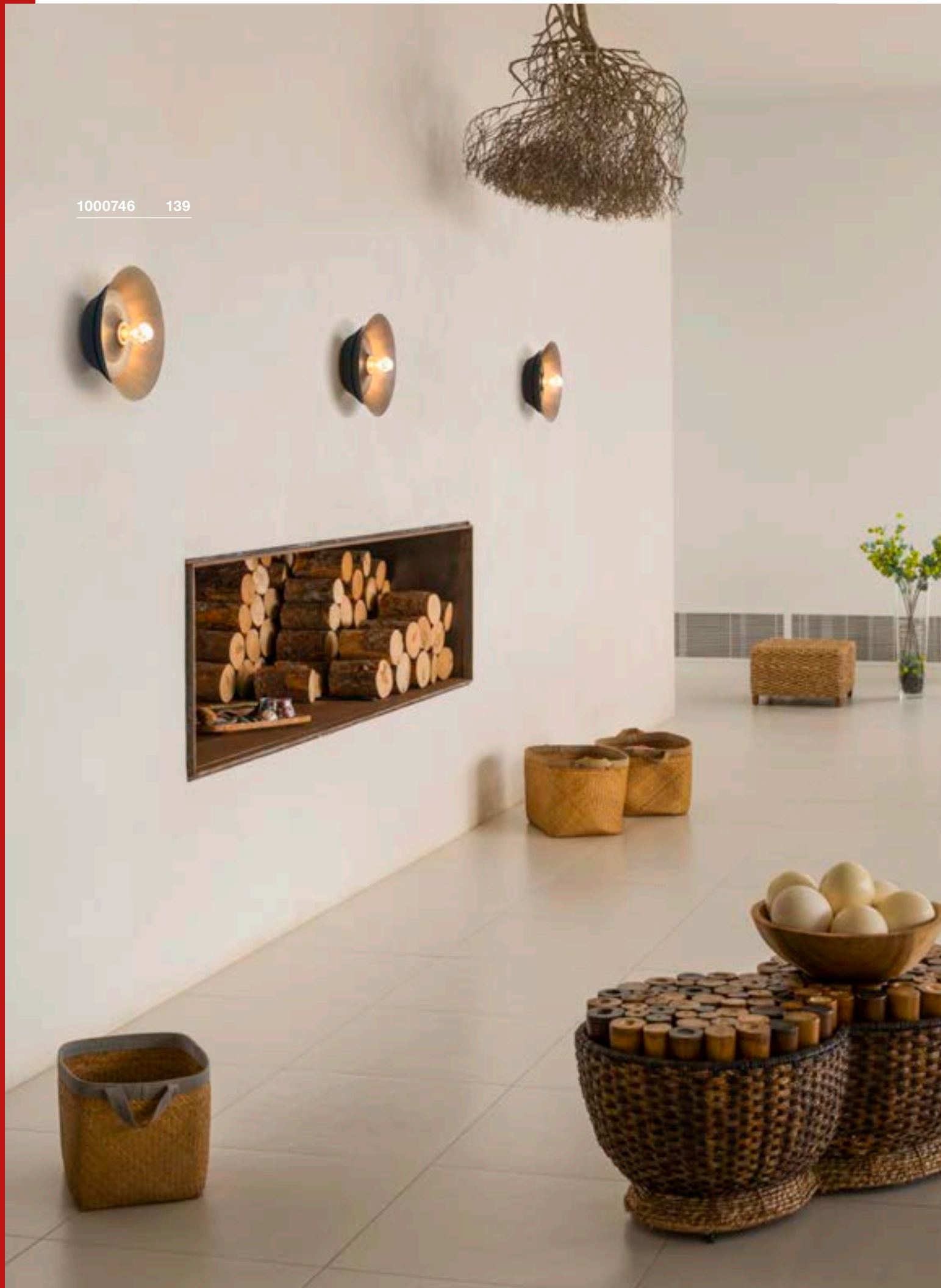



1000745 139

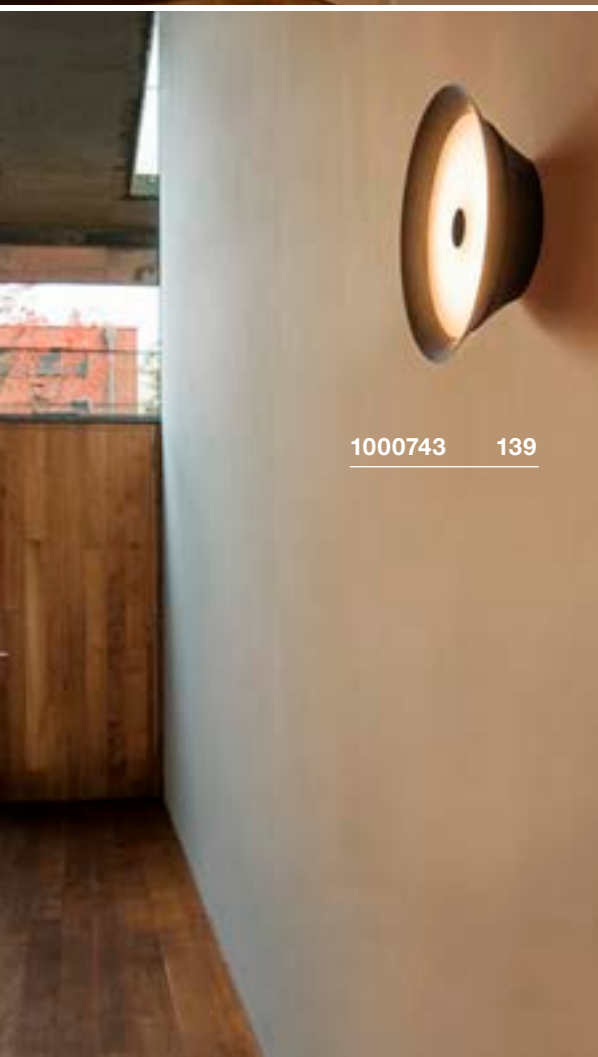

1000743 139

BATO 35
CW, TRIAC



A-A++ Spektrum A++-E

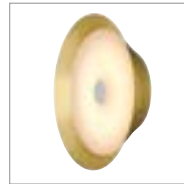

Produktangaben

220-240V ~50/60Hz | 700mA
Systemleistung: 15W
Material: Aluminium / Polymethylacrylat (PMMA)
Dimmbar: Triac C

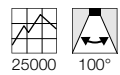
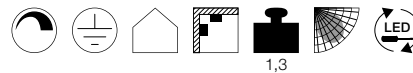

Maßzeichnung

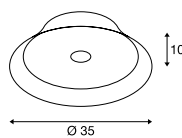

BATO 35
CW, E27



E-A++ Spektrum A++-E



Produktangaben

220-240V ~50/60Hz
Material: Aluminium / Stahl

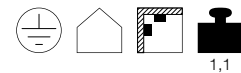

Maßzeichnung

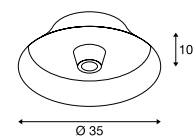

Leuchtmittlempfehlung

LED E27 7,1W 330°
2700K 806lm EEK=A+
8kWh/1000h
Art. Nr. 1001756



LED E27 7W 180°
2700K 630lm EEK=A+
8kWh/1000h
Art. Nr. 1001357



Leuchtmittelangaben

max. 60W

Variante	Art. Nr.
850lm 2700K CRI>80	
■ schwarz	1000743
1050lm 2500K CRI>80	
■ matt messing	1000745

Variante	Art. Nr.
E27	
■ schwarz	1000746
E27	
■ messing	1000748

ONE 40
WL, DALI



A-A++ Spektrum
A++-E



- Lichtfarbe schaltbar

Produktangaben

220-240V ~50/60Hz | 350mA
Systemleistung: 14W
Material: Aluminium / Stahl
Dimmbar: Dali

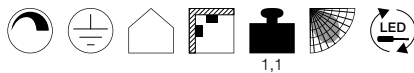

1,1



30000

Maßzeichnung

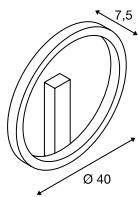

ONE 60
WL, DALI



A-A++ Spektrum
A++-E



- Lichtfarbe schaltbar

Produktangaben

220-240V ~50/60Hz | 600mA
Systemleistung: 25W
Material: Aluminium / Stahl
Dimmbar: Dali

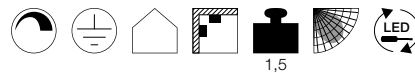

1,5



30000

Maßzeichnung

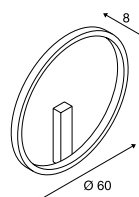

1002918 140

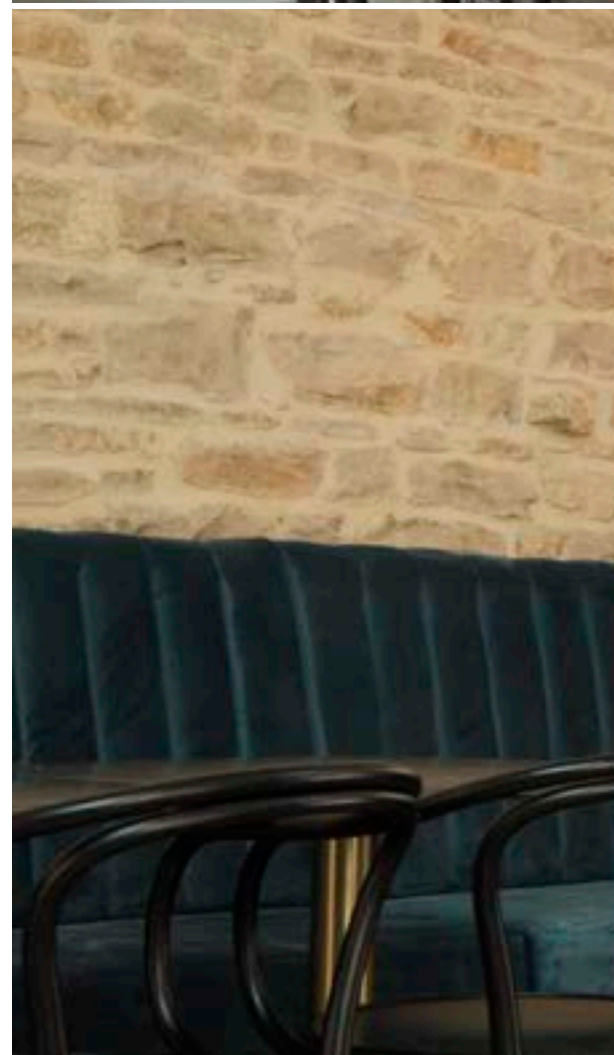

Variante	Art. Nr.
720/770lm 3000/4000K CRI>80 ■ matt schwarz / schwarz	1002915
720/770lm 3000/4000K CRI>80 □ matt weiß / weiß	1002917

Variante	Art. Nr.
1400/1500lm 3000/4000K CRI>80 ■ matt schwarz / schwarz	1002918
1400/1500lm 3000/4000K CRI>80 □ matt weiß / weiß	1002919



1002919 140

BRENDA
WL

885

A-A++ Spektrum
A++-ELED
INSIDEred dot award 2018
winner

- Einstellbarer Spot
- Lichtquellen zusammen oder getrennt schaltbar
- Zusätzlich kann die Leuchte noch extern geschaltet werden

Produktangaben

220-240V ~50/60Hz | 500mA
 Systemleistung: 14W
 Material: Aluminium / Glas
 Dimmbar: Triac C, Triac L

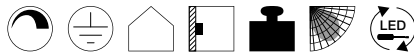

1,5

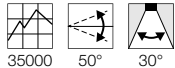

35000 50° 30°

Maßzeichnung

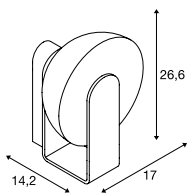
red dot award 2018
winner

DESIGNED BY

Johannes Tomm

149431

142

Variante	Art. Nr.
Indirekt: 880lm 3000K CRI>80	
Spot: 80lm 3000K CRI>80	
weiß / matt grau	149431



155752 143



155752 143

LISENNE
WL, E27
 890
E-A++ Spektrum
A++-E

- Basaltstein & Rauchglas

Produktangaben

220-240V ~50/60Hz
Material: Basalt / Glas

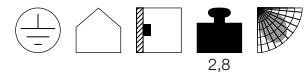

Maßzeichnung

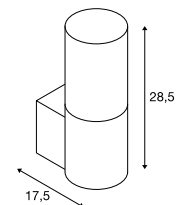

Leuchtmittelempfehlung

LED E27 7,1W 330°
2700K 806lm EEK=A+
8kWh/1000h
Art. Nr. 1001756



Leuchtmittelangaben

max. 23W
Ø: 5,9 cm max. L: 15 cm max.

Variante	Art. Nr.
E27 ■ grau / braun	155752

ANDREAS
WL, QT-DE12

1002926 144

D-A+ Spektrum A++-E

NEW



Produktangaben

220-240V ~50/60Hz
Material: Aluminium / Stahl



0,56

100°

Maßzeichnung

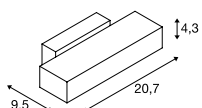

Leuchtmittelpfhlung

R7s 118mm 10,5W 330°
3000K 1050lm EEK=A+
11kWh/1000h
Art. Nr. 560352



LED R7s 118mm 14W
3000K 2000lm EEK=A++
14kWh/1000h
Art. Nr. 1002135



Leuchtmittelangaben

max. 80W

Variante	Art. Nr.
R7s 118mm matt weiß / weiß	1002925
R7s 118mm matt grau / grau	1002926
R7s 118mm matt schwarz / schwarz	1002927

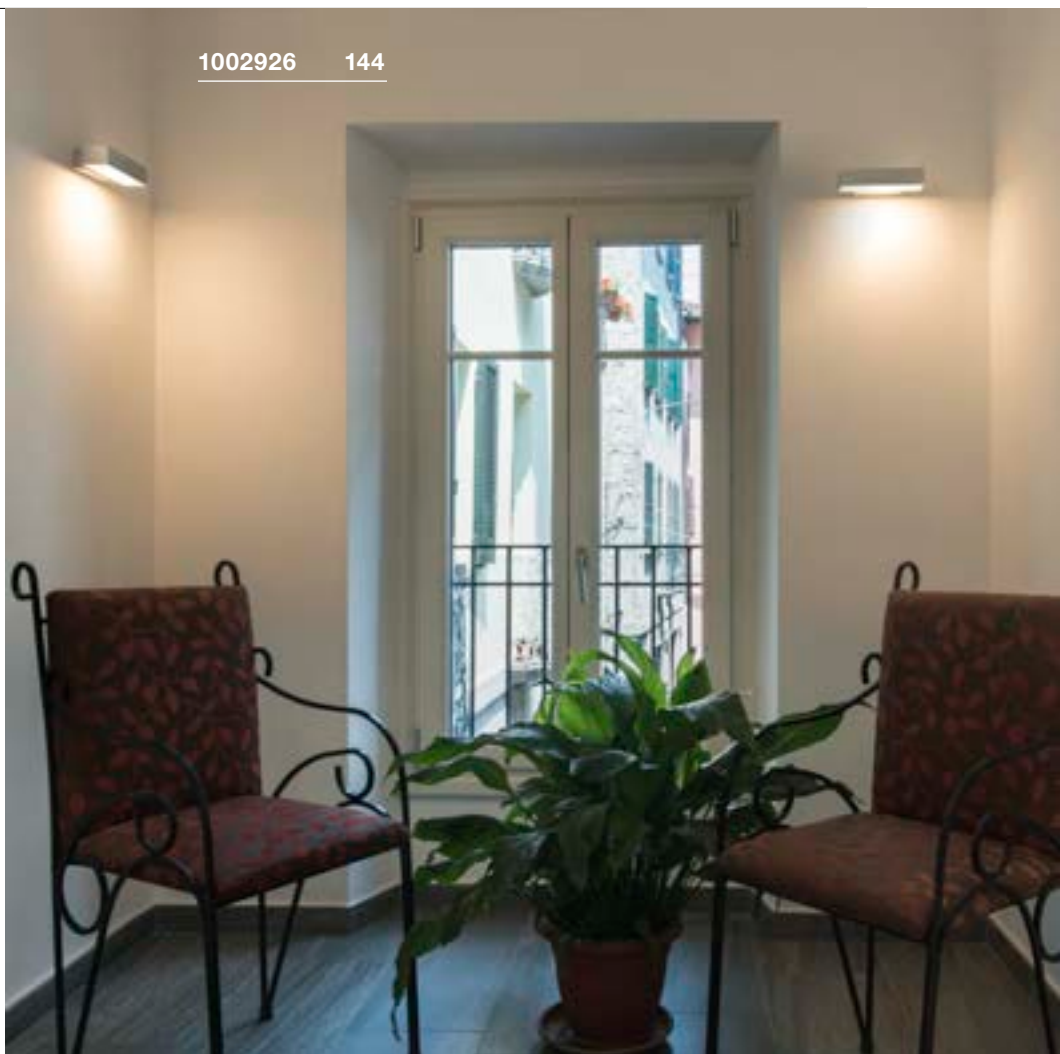

1002993 145

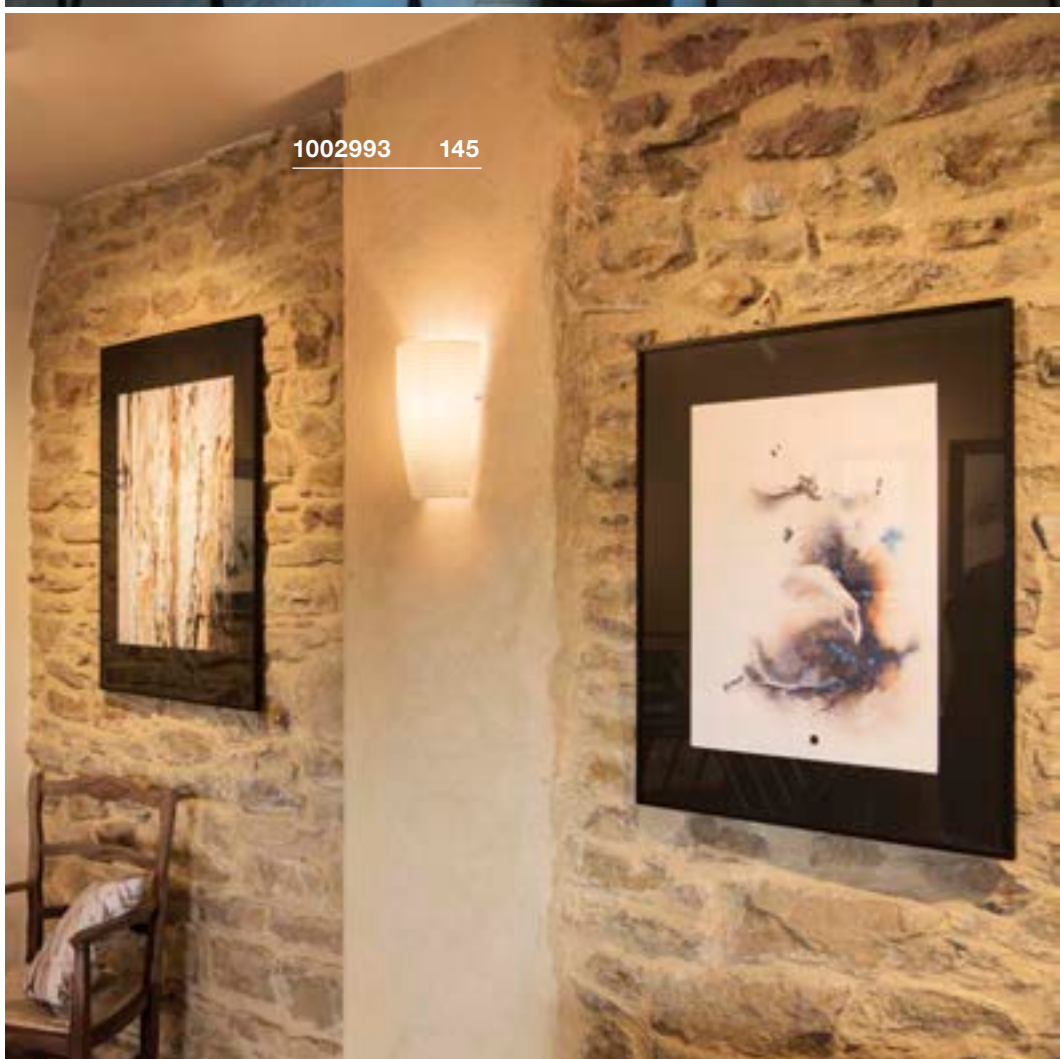

DENA 30
WL, E14

E-A++ Spektrum A++-E

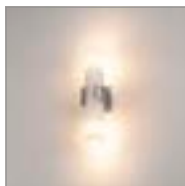

PURISA
WL, E27

E-A++ Spektrum A++-E



BASKET
WL, E27

E-A++ Spektrum A++-E

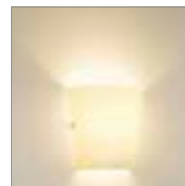

• Hochwertiges satiniertes Glas

Produktangaben

230V ~50Hz
Material: Aluminium / Glas

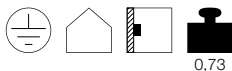

0,73

Maßzeichnung

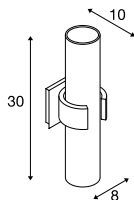

Produktangaben

220-240V ~50/60Hz
Material: Stahl / Glas

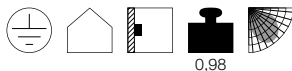

0,98

Maßzeichnung

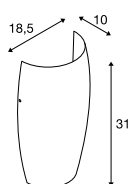

Produktangaben

230V ~50Hz
Material: Aluminium / Glas

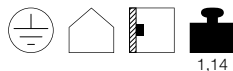

1,14

Maßzeichnung

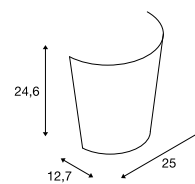

Leuchtmittlempfehlung

E14 4W
2700K 250lm EEK=A+
4kWh/1000h
Art. Nr. 560222



Leuchtmittelangaben

2x max. 40W C35
Ø: 5 cm max. L: 9,6 cm max.

Variante	Art. Nr.
E14 C35	
□ matt aluminium	147529

Leuchtmittlempfehlung

LED E27 9,1W 240°
2700K 760lm EEK=A+
10kWh/1000h
Art. Nr. 560402



LED E27 9,5W 240°
2200-6700K 806lm EEK=A+
10kWh/1000h
Art. Nr. 1001917



Leuchtmittelangaben

max. 40W
Ø: 8 cm max. L: 15 cm max.

Variante	Art. Nr.
E27	
□ glänzend weiß / milchig	1002993

Leuchtmittlempfehlung

LED E27 9,1W 240°
2700K 760lm EEK=A+
10kWh/1000h
Art. Nr. 560402



LED E27 9,5W 240°
2200-6700K 806lm EEK=A+
10kWh/1000h
Art. Nr. 1001917



Leuchtmittelangaben

max. 60W
Ø: 5,2 cm max. L: 15,2 cm max.

Variante	Art. Nr.
E27	
□ weiß	151591

FITU
WL, E27



E-A++ Spektrum A++-E



Produktangaben

220-240V ~50/60Hz
Material: Aluminium / Stahl

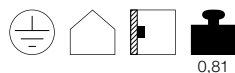

Maßzeichnung

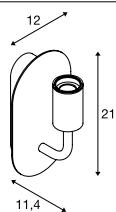

Leuchtmittlempfehlung

E27 5W 330°
2000K 500lm EEK=A+
5kWh/1000h
Art. Nr. 560741



LED E27 7W 330°
2700K 806lm EEK=A+
8kWh/1000h
Art. Nr. 1001038



Leuchtmittelangaben

max. 24W

Variante	Art. Nr.
E27 weiß	1002147
E27 schwarz	1002148
E27 gold	1002149

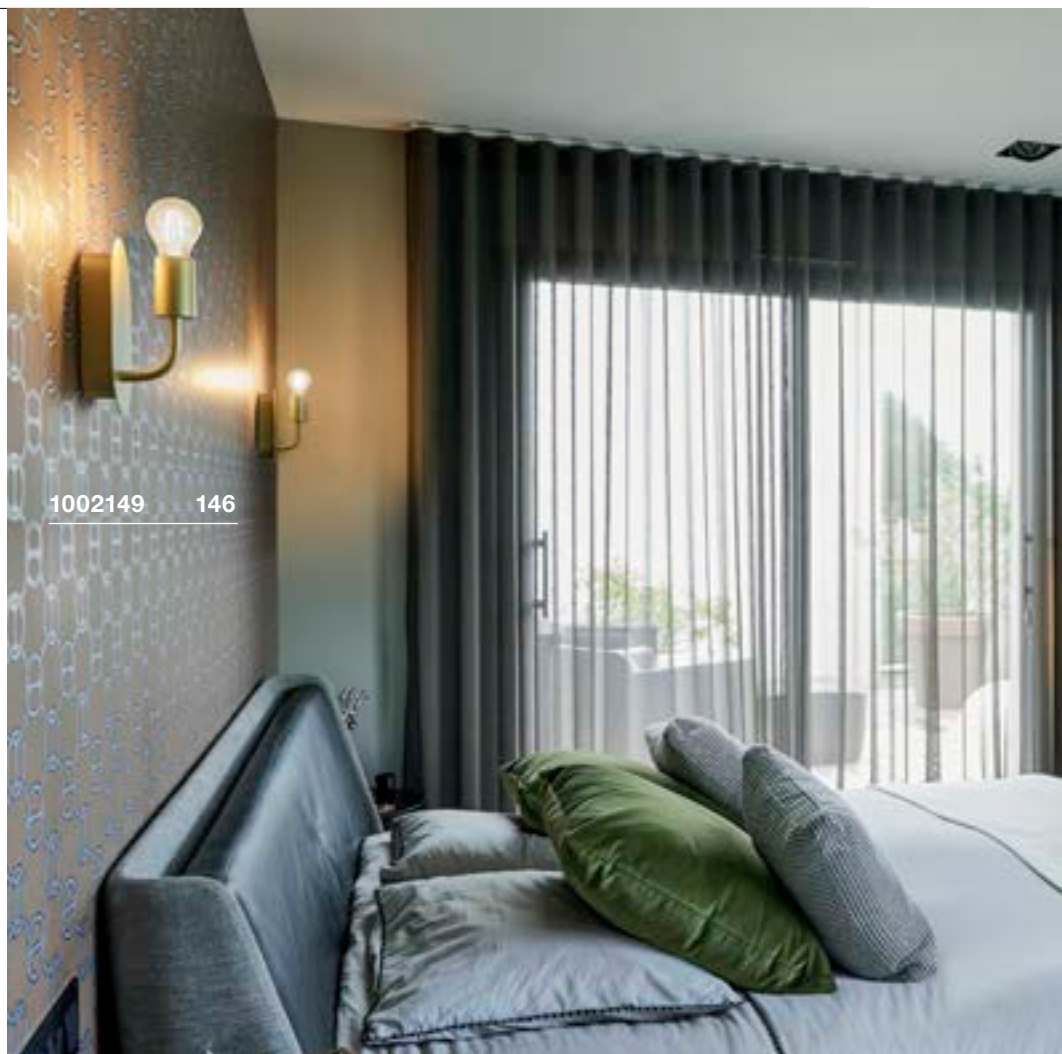

1002149 146

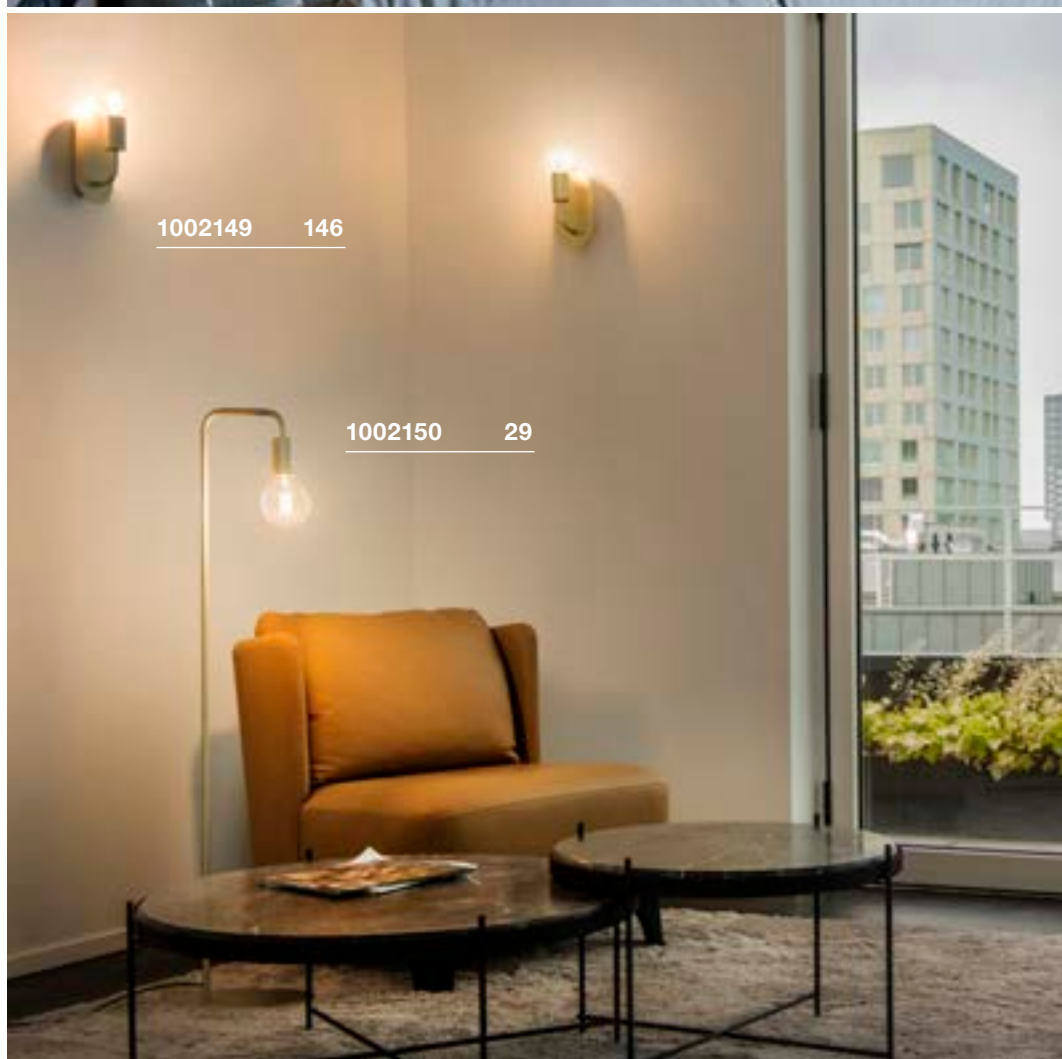

1002149 146

1002150 29



155861 147

SOPRANA OVAL
WL, E27 896E-A++  Spektrum
A++-E

Produktangaben

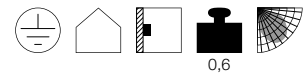
230V ~50Hz
Material: Stahl / Textil

Maßzeichnung

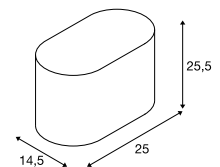

Leuchtmittlempfehlung

LED E27 7W 280°
2700K 790lm EEK=A++
7kWh/1000h

Art. Nr. 1002124

LED E27 9W 240°
2700-6500K 806lm EEK=A+
9kWh/1000h

Art. Nr. 1001916



Leuchtmittelangaben

max. 60W
L: 13 cm max.

Variante	Art. Nr.
E27 <input type="checkbox"/> weiß	155861

FENDA
WL, Basis, E27



E-A++ Spektrum A++-E



FENDA
Halbschirm



- Durch Auswahl einer geeigneten Leuchtenbasis individuell gestaltbar

Produktangaben

230V ~50/60Hz
Material: Stahl / Kunststoff

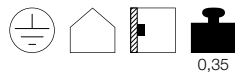

Maßzeichnung

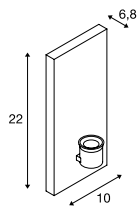

Produktangaben

Material: Textil / Stahl



Maßzeichnung

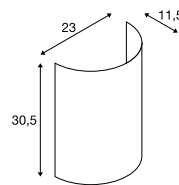

Hinweis

max. 40W

Leuchtmittlempfehlung

LED E27 9,1W 240°
2700K 760lm EEK=A+
10kWh/1000h
Art. Nr. 560402



LED E27 9W 240°
2700-6500K 806lm EEK=A+
9kWh/1000h
Art. Nr. 1001916



Leuchtmittelangaben

max. 40W
Ø: 5 cm max. L: 20 cm max.

Variante	Art. Nr.
E27	
<input type="checkbox"/> weiß	1001272

Variante	Art. Nr.
<input checked="" type="checkbox"/> schwarz	1001273
<input checked="" type="checkbox"/> schwarz / kupfer	1001274
<input type="checkbox"/> weiß	1001275
<input type="checkbox"/> beige	1001276

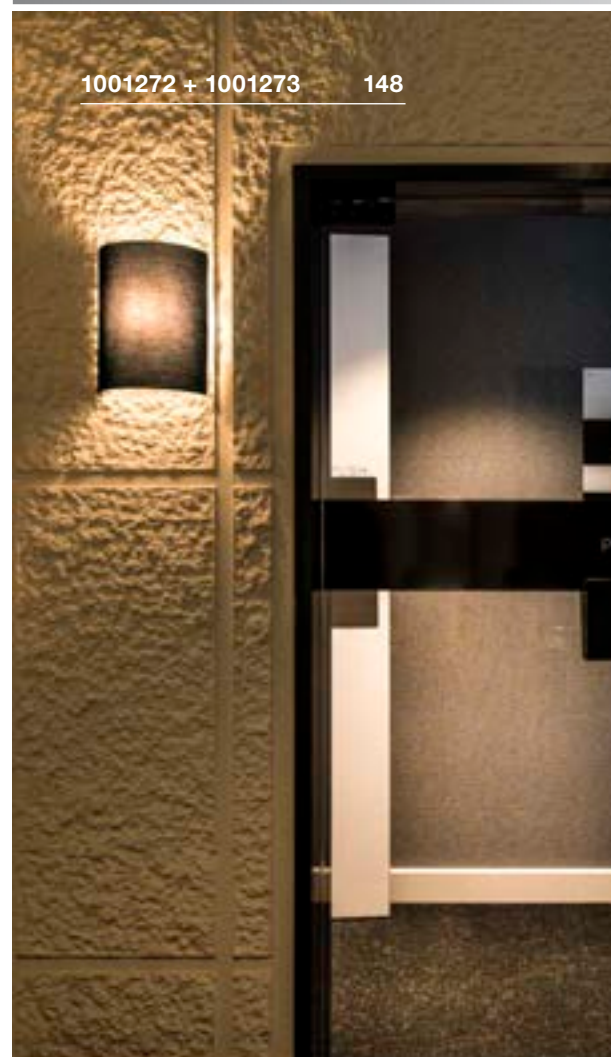



155340 149



155643 149

LASSON
WL, E27



E-A++ Spektrum A++-E



Produktangaben

230V ~50Hz
Material: Textil / Stahl

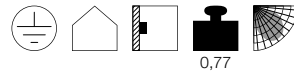

Maßzeichnung

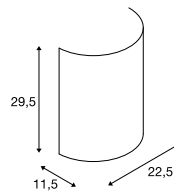

Leuchtmittlempfehlung

LED E27 7W 280°
2700K 790lm EEK=A++
7kWh/1000h
Art. Nr. 1002124



LED E27 7W 280°
2200-2700K 830lm EEK=A++
7kWh/1000h
Art. Nr. 1002126



Leuchtmittelangaben

max. 40W
Ø: 5 cm max. L: 20 cm max.

Variante	Art. Nr.
E27	
■ schwarz	155340

SOPRANA
WL, E27



E-A++ Spektrum A++-E



Produktangaben

230V ~50Hz
Material: Textil / Stahl

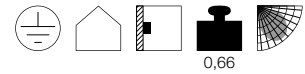

Maßzeichnung

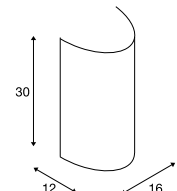

Leuchtmittlempfehlung

LED E27 9,1W 240°
2700K 760lm EEK=A+
10kWh/1000h
Art. Nr. 560402



LED E27 9W 240°
2700-6500K 806lm EEK=A+
9kWh/1000h
Art. Nr. 1001916



Leuchtmittelangaben

max. 40W
Ø: 6,6 cm max. L: 17,3 cm max.

Variante	Art. Nr.
E27	
■ beige	155643

MANA
WL, Basis, TRIAC



A-A++ Spektrum
A++-E



- Premium LED mit CRI>90
- Dim to Warm

Produktangaben

220-240V ~50/60Hz | 350mA
Systemleistung: 8W
Material: Aluminium / Stahl
Dimmbar: Triac C

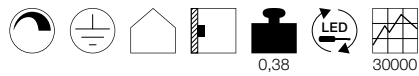

Maßzeichnung

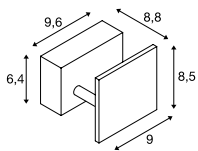

1000613 + 1000618 150 + 151

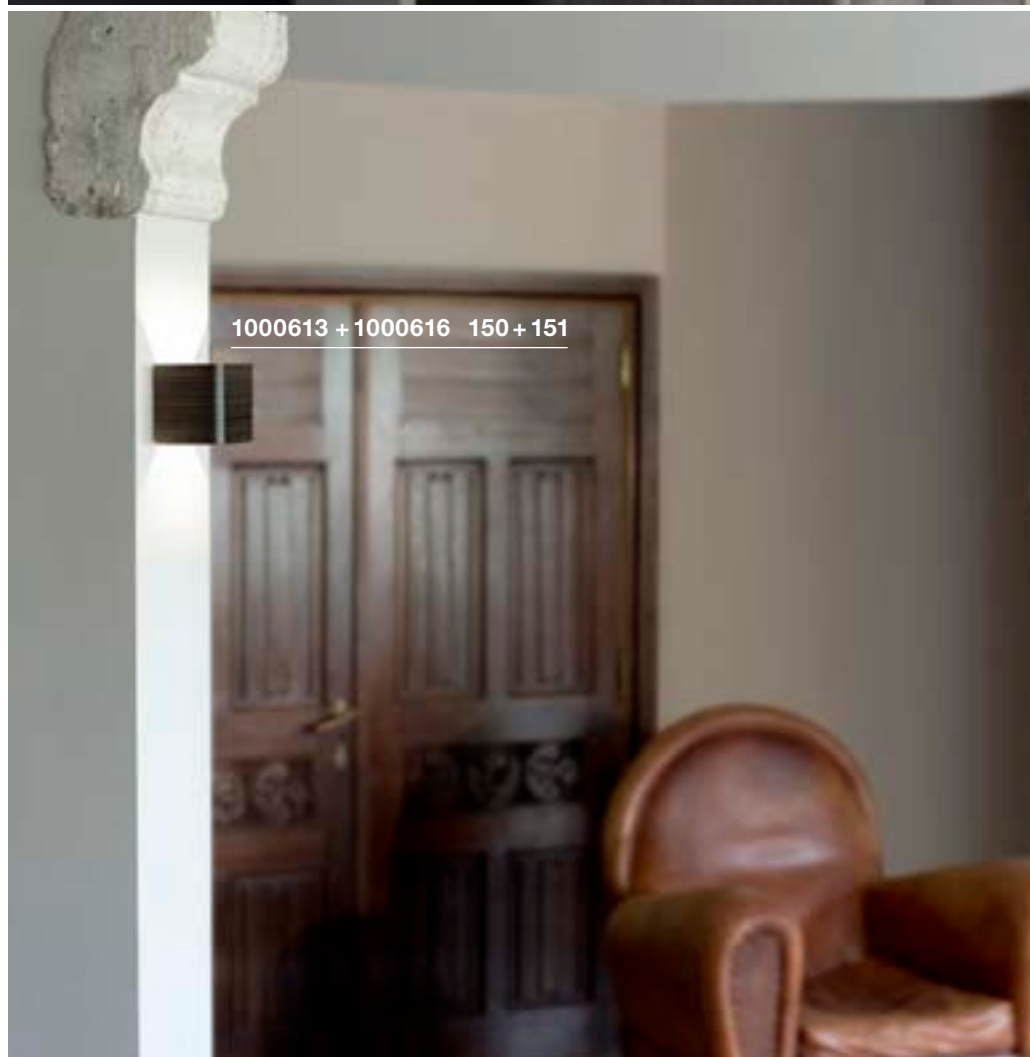

1000613 + 1000616 150 + 151

Variante	Art. Nr.
320lm 2000-3000K CRI>90 □ weiß	1000613



MANA Schirm



MANA Schirm



- Individuell gestaltbar mit Farben, Stickern & mehr

Produktangaben

Material: Gips / Stahl



Maßzeichnung

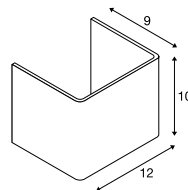

Hinweis

passend nur zu 1000613

Maßzeichnung

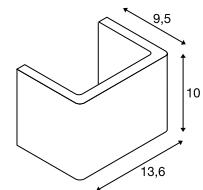

Hinweis

passend nur zu 1000613

Variante	Art. Nr.
Holz 0,11 kg	
■ grau / braun	1000616
Aluminium 0,29 kg	
□ weiß	1000618
Aluminium 0,29 kg	
□ aluminium	1000619

Variante	Art. Nr.
□ weiß	1000824

MANA
WL, Basis, TRIAC



A-A++ Spektrum
A++-E



- Premium LED mit CRI>90
- Dim to Warm

Produktangaben

220-240V ~50/60Hz | 350mA
Systemleistung: 15W
Material: Aluminium / Stahl
Dimmbar: Triac C

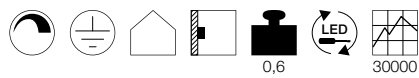

Maßzeichnung

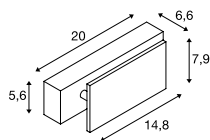

1000614 + 1000629 152 + 153



Variante	Art. Nr.
700lm 2000-3000K CRI>90 □ weiß	1000614

MANA
Schirm



MANA
Schirm

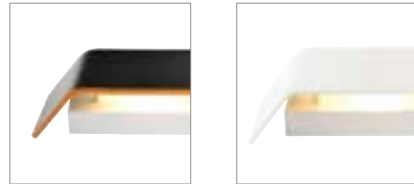

MANA
Schirm

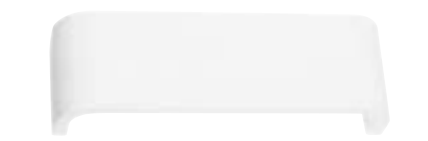

- Individuell gestaltbar mit Farben, Stickern & mehr

Produktangaben

Material: Gips / Stahl



Maßzeichnung

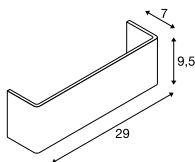

Hinweis

passend nur zu 1000614/1000615



Maßzeichnung

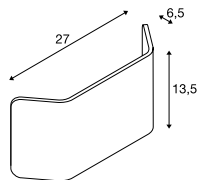

Hinweis

passend nur zu 1000614/1000615

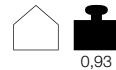

Maßzeichnung

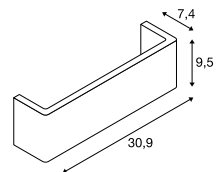

Hinweis

passend nur zu 1000614/1000615

Variante	Art. Nr.
Holz 0,16 kg ■ grau / braun	1000621
Aluminium 0,39 kg □ weiß	1000623
Aluminium 0,39 kg ■ aluminium	1000624

Variante	Art. Nr.
Holz 0,2 kg ■ grau / braun	1000626
Aluminium 0,47 kg □ weiß	1000628
Aluminium 0,47 kg ■ aluminium	1000629

Variante	Art. Nr.
□ weiß	1000825

PLASTRA

WL, rectangular, QT-DE12



893

D-A+ Spektrum
A++-E

NEW



- Individuell gestaltbar mit Farben, Stickern & mehr

148018 155

Produktangaben

220-240V ~50/60Hz
Material: Gips / Stahl

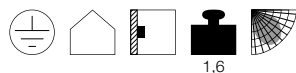

1,6

Maßzeichnung

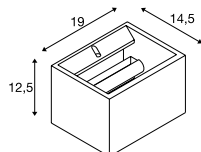

Leuchtmittlempfehlung

R7s 118mm 10,5W 330°
3000K 1050lm EEK=A+
11kWh/1000h

Art. Nr. 560352

LED R7s 118mm 14W
3000K 2000lm EEK=A++
14kWh/1000h

Art. Nr. 1002135



Leuchtmittelangaben

max. 20W

Variante Art. Nr.

R7s 118mm

weiß

1002238

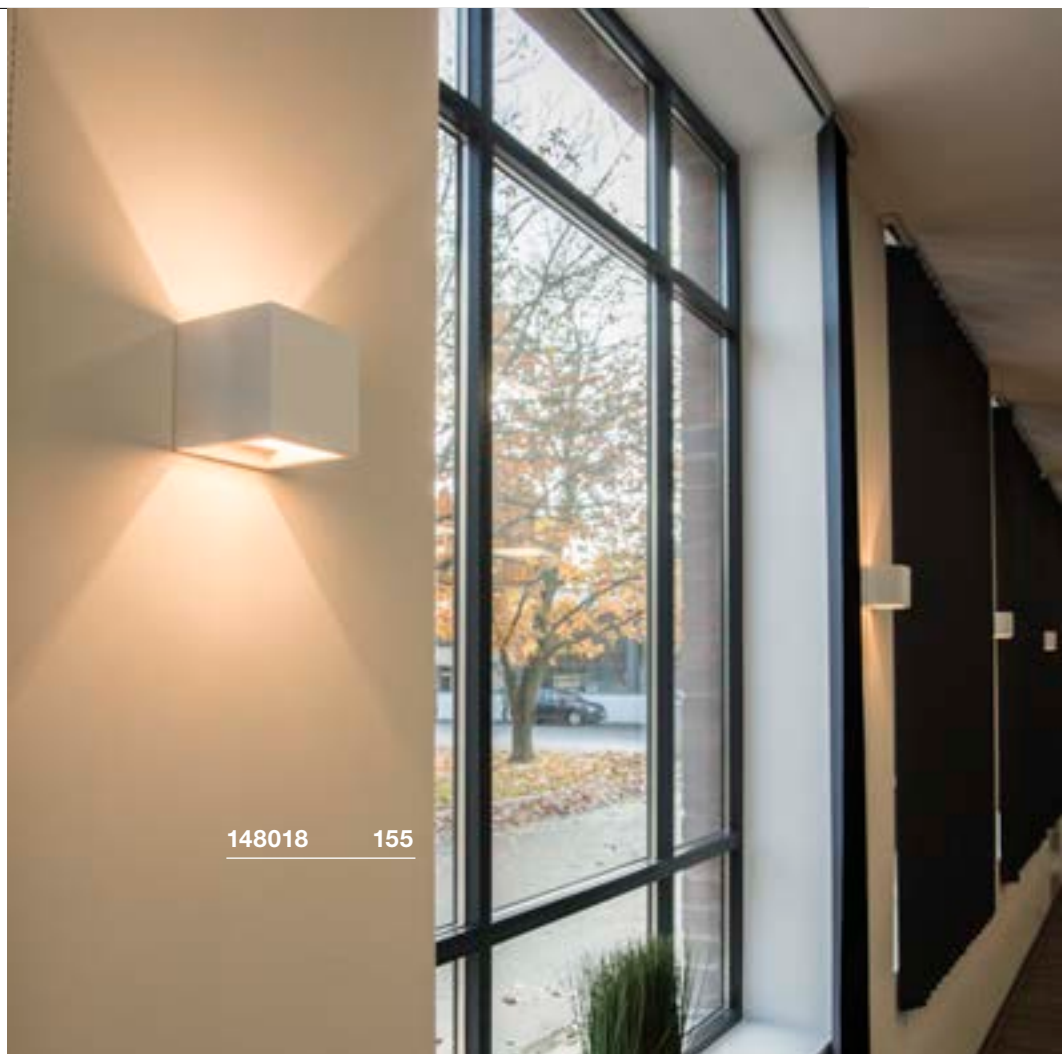

1002238 154





1000910 155



1000911 155

SOLID CUBE
WL, QT14

D-A+ Spektrum A++-E

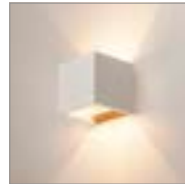
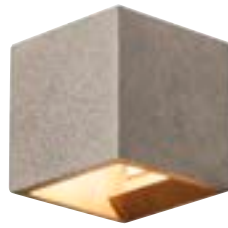

Produktangaben

230V ~50Hz
Material: Beton

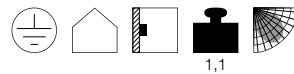

1,1

Maßzeichnung

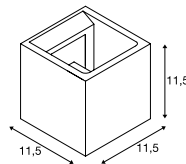

PLASTRA
WL, Cube, QT14

893

D-A+ Spektrum A++-E

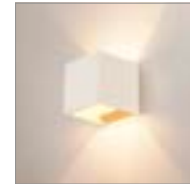
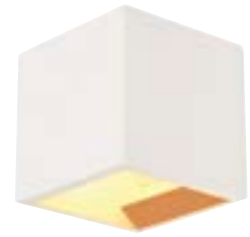

- Individuell gestaltbar mit Farben, Stickern & mehr

Produktangaben

230V ~50Hz
Material: Gips / Stahl

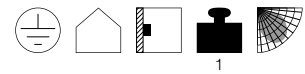

1

Maßzeichnung

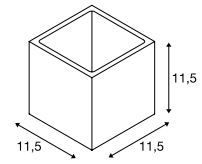

Leuchtmittlempfehlung

G9 2,5W
2700K 180lm EEK=A+
3kWh/1000h
Art. Nr. 560302



Leuchtmittelangaben

max. 25W QT14

Variante	Art. Nr.
G9 QT14	
■ grau	1000910
G9 QT14	
■ schwarz	1000911

Leuchtmittlempfehlung

LED G9 3,5W
2800K 300lm EEK=A+
4kWh/1000h
Art. Nr. 1002131



Leuchtmittelangaben

max. 42W QT14

Variante	Art. Nr.
G9 QT14	
□ weiß	148018

LOGS IN
WL



A-A++ Spektrum A++-E



- Premium LED mit CRI>90
- Dim to Warm

Produktangaben

220-240V ~50/60Hz | 250mA
Systemleistung: 12W
Material: Aluminium
Dimmbar: Triac C, Triac L

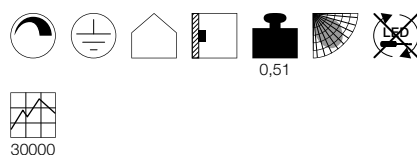

Maßzeichnung

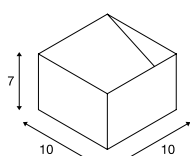

LOGS IN
WL



A-A++ Spektrum A++-E



Produktangaben

100-240V ~50/60Hz | 500mA
Systemleistung: 6,9W
Material: Aluminium



Maßzeichnung

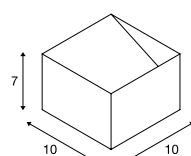

1000640 156



151320 156



Variante	Art. Nr.
290lm 2000-3000K CRI>90 ■ schwarz / gold	1000638
490lm 2000-3000K CRI>90 □ weiß	1000639
490lm 2000-3000K CRI>90 ■ aluminium / weiß	1000640

Variante	Art. Nr.
390lm 3000K CRI>90 ■ schwarz / gold	151320
440lm 3000K CRI>90 □ weiß	151321
440lm 3000K CRI>90 ■ aluminium / weiß	151325



1002843 157



1002928 157

LOGS IN L
WL



A-A++ Spektrum
A++-E



LED
INSIDE

NEW

Dim to
WARM



- Premium LED mit CRI>90
- Dim to Warm

Produktangaben

220-240V ~50/60Hz | 500mA
Systemleistung: 19W
Material: Aluminium
Dimmbar: Triac C, Triac L

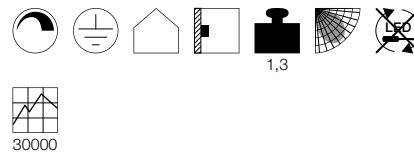

Maßzeichnung

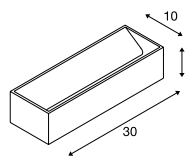

Variante	Art. Nr.
1500lm 2000-3000K CRI>90	
■ schwarz / gold	1002930
1500lm 2000-3000K CRI>90	
□ weiß	1002929
1100lm 2000-3000K CRI>90	
▒ aluminium / weiß	1002928

LOGS IN L
WL, TRIAC



A-A++ Spektrum
A++-E



LED
INSIDE

NEW

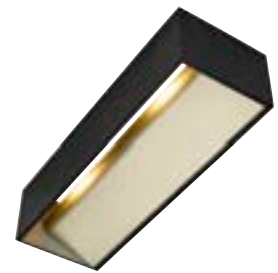

- Premium LED mit CRI>90

Produktangaben

220-240V ~50/60Hz | 500mA
Systemleistung: 17W
Material: Aluminium
Dimmbar: Triac C, Triac L

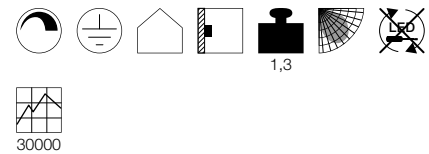

Maßzeichnung

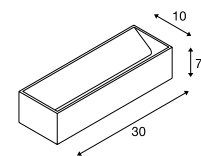

Variante	Art. Nr.
1100lm 3000K CRI>90	
■ schwarz / gold	1002842
1400lm 3000K CRI>90	
□ weiß	1002844
1400lm 3000K CRI>90	
▒ aluminium / weiß	1002843

QUAD UP/DOWN 12
WL



A-A++ Spektrum
A++-E



QUAD UP/DOWN 15
WL



A-A++ Spektrum
A++-E

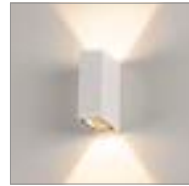

Produktangaben

200-240V ~50/60Hz | 700mA
Systemleistung: 6,8W
Material: Aluminium / Glas

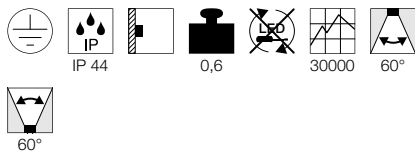

Maßzeichnung

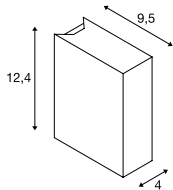

Produktangaben

100-277V ~50/60Hz | 350mA
Systemleistung: 8,6W
Material: Aluminium / Glas

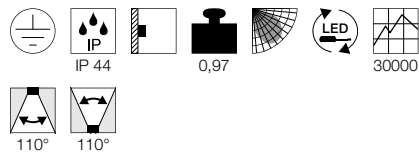

Maßzeichnung

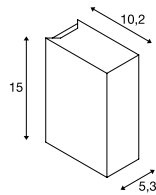

Variante	Art. Nr.
175lm 3000K CRI>80	
□ weiß	232471
140lm 3000K CRI>80	
■ anthrazit	232475

Variante	Art. Nr.
Up: 290lm 3000K CRI>80	
Down: 290lm 3000K CRI>80	
□ weiß	232441
Up: 260lm 3000K CRI>80	
Down: 260lm 3000K CRI>80	
■ anthrazit	232445

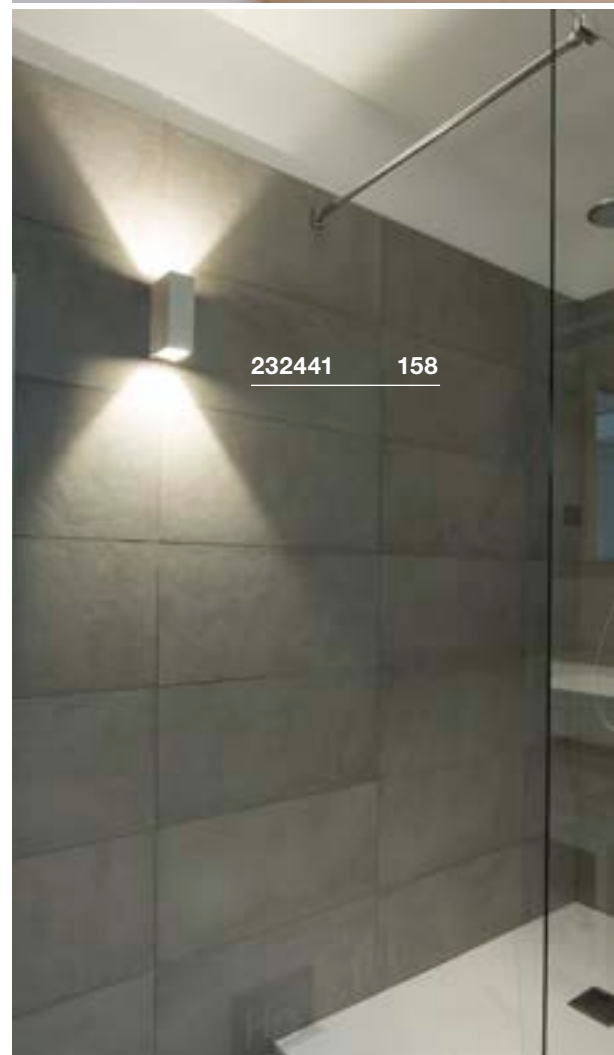



148010 159



148015 159

PLASTRA
WL, slot, E14



E-A++ Spektrum A++-E

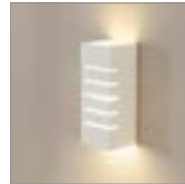

- Individuell gestaltbar mit Farben, Stickern & mehr

Produktangaben

230V ~50Hz
Material: Gips / Stahl

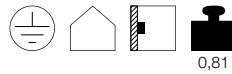

0,81

Maßzeichnung

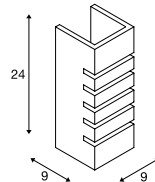

Leuchtmittlempfehlung

LED E14 6,5W 280°
3000K 480lm EEK=A+
7kWh/1000h
Art. Nr. 560372



Leuchtmittelangaben

max. 40W C35

Variante	Art. Nr.
E14 C35	
<input type="checkbox"/> weiß	148010

PLASTRA
WL, QPAR51



E-A++ Spektrum A++-E



- Individuell gestaltbar mit Farben, Stickern & mehr

Produktangaben

220-240V ~50/60Hz
Material: Gips / Stahl

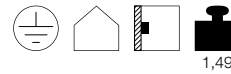

1,49

Maßzeichnung

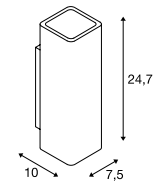

Leuchtmittlempfehlung

LED GU10 7,2W 36°
3000K 520lm EEK=A+
8kWh/1000h
Art. Nr. 1001562



LED GU10 7,2W 36°
4000K 540lm EEK=A+
8kWh/1000h
Art. Nr. 1001565



Leuchtmittelangaben

2x max. 35W QPAR51

Variante	Art. Nr.
GU10 QPAR51	
<input type="checkbox"/> weiß	148015

1000327 161



THEO UP/DOWN
WL, QPAR51E-A++ Spektrum
A++-E

Produktangaben

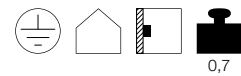
230V ~50Hz
Material: Aluminium

Maßzeichnung

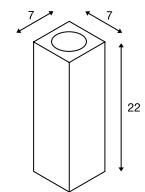

1000330 + 1000327 161

Leuchtmittlempfehlung

LED GU10 7,2W 36°
4000K 540lm EEK=A+
8kWh/1000h
Art. Nr. 1001566LED GU10 5,5W 38°
2700K 400lm EEK=A+
6kWh/1000h
Art. Nr. 1001030

Leuchtmittelangaben

2x max. 50W QPAR51

Variante	Art. Nr.
GU10 QPAR51 weiß	1000327
GU10 QPAR51 grau	1000328
GU10 QPAR51 matt aluminium	1000329
GU10 QPAR51 anthrazit	1000330

CHROMBO
WL

A-A++ Spektrum A++-E 

LED INSIDE

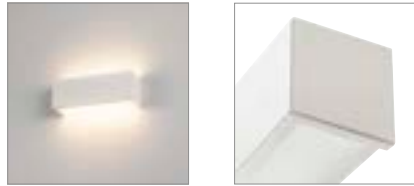

TANI
WL, QT-DE12

D-A+ Spektrum A++-E 

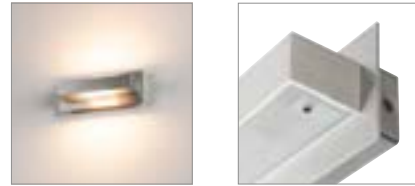

Produktangaben

220-240V ~50/60Hz
Systemleistung: 9,7W
Material: Stahl / Glas
Dimmbar: Triac C, Triac L

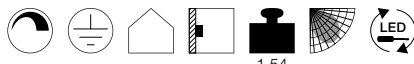
 1,54

 35000

Produktangaben

230V ~50Hz
Material: Aluminium / Glas

 0,8

Maßzeichnung

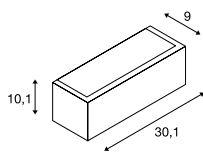

Maßzeichnung

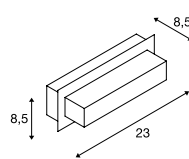

Leuchtmittlempfehlung

R7s 118mm 10,5W 330°
3000K 1050lm EEK=A+
11kWh/1000h
Art. Nr. 560352

LED R7s 118mm 14W
3000K 2000lm EEK=A++
14kWh/1000h
Art. Nr. 1002135

Leuchtmittelangaben

max. 200W QT-DE12

Variante	Art. Nr.
480lm 3000K CRI>80 □ weiß	155221
480lm 3000K CRI>80 ■ matt grau	155228

Variante	Art. Nr.
R7s 118mm QT-DE12 □ matt aluminium	147566

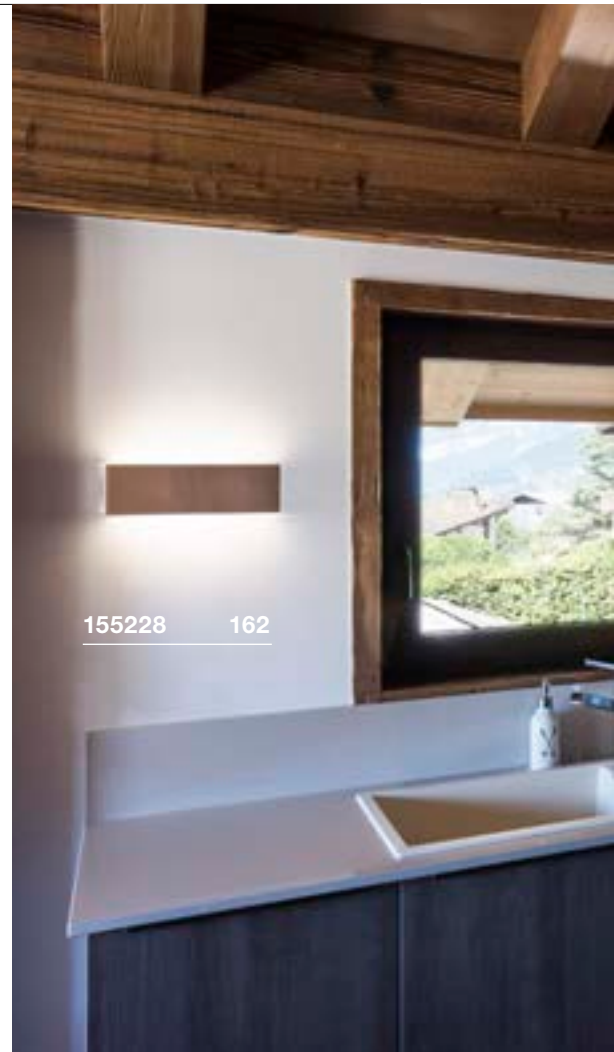



149511 163



149511 163

WL 149
WL, QT-DE12

D-A+ Spektrum A++-E



Produktangaben

230V ~50Hz
Material: Stahl / Glas

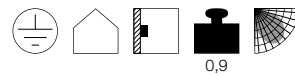

Maßzeichnung

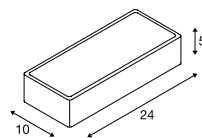

Leuchtmittlempfehlung

R7s 78mm 5,5W 330°
3000K 530lm EEK=A+
6kWh/1000h
Art. Nr. 560332



Leuchtmittelangaben

max. 60W QT-DE12

Variante	Art. Nr.
R7s 78mm QT-DE12	
□ matt weiß	149471
R7s 78mm QT-DE12	
■ chrom	149472

WL 149
WL

A-A++ Spektrum A++-E



Produktangaben

220-240V ~50/60Hz | 500mA
Systemleistung: 16W
Material: Stahl / Glas



Maßzeichnung

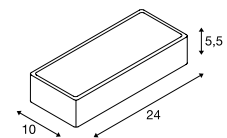

Variante	Art. Nr.
1060lm 3000K CRI>80	
□ weiß	149511
1060lm 3000K CRI>80	
■ chrom	149512

SEDO 7
WL

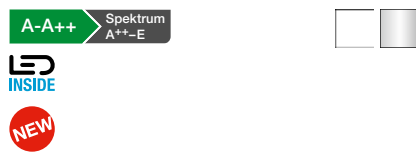

SEDO 14
WL



SEDO 21
WL

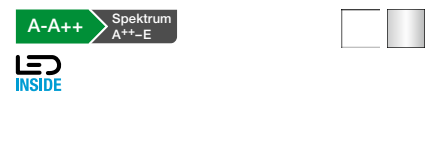

Produktangaben

220-240V ~50/60Hz | 350mA
Systemleistung: 11,5W
Material: Aluminium / Glas

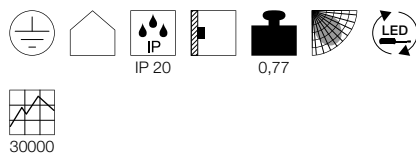

Produktangaben

220-240V ~50/60Hz | 500mA
Systemleistung: 16W
Material: Aluminium / Glas

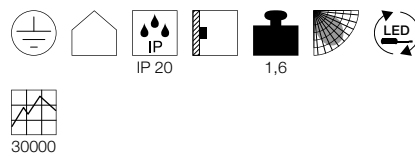

Produktangaben

220-240V ~50/60Hz | 700mA
Systemleistung: 30W
Material: Aluminium / Glas

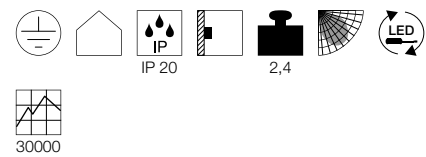

Maßzeichnung

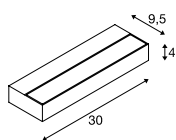

Maßzeichnung

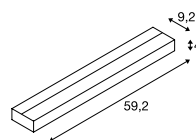

Maßzeichnung

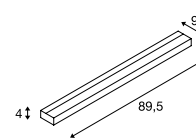

Variante	Art. Nr.
1020lm 3000K CRI>80 <input type="checkbox"/> weiß	1002962
1020lm 3000K CRI>80 <input type="checkbox"/> matt aluminium	1002964

Variante	Art. Nr.
1300lm 3000K CRI>80 <input type="checkbox"/> weiß	151781
1300lm 3000K CRI>80 <input type="checkbox"/> matt aluminium	151786

Variante	Art. Nr.
2500lm 3000K CRI>80 <input type="checkbox"/> weiß	151791
2500lm 3000K CRI>80 <input type="checkbox"/> matt aluminium	151796



151781 164

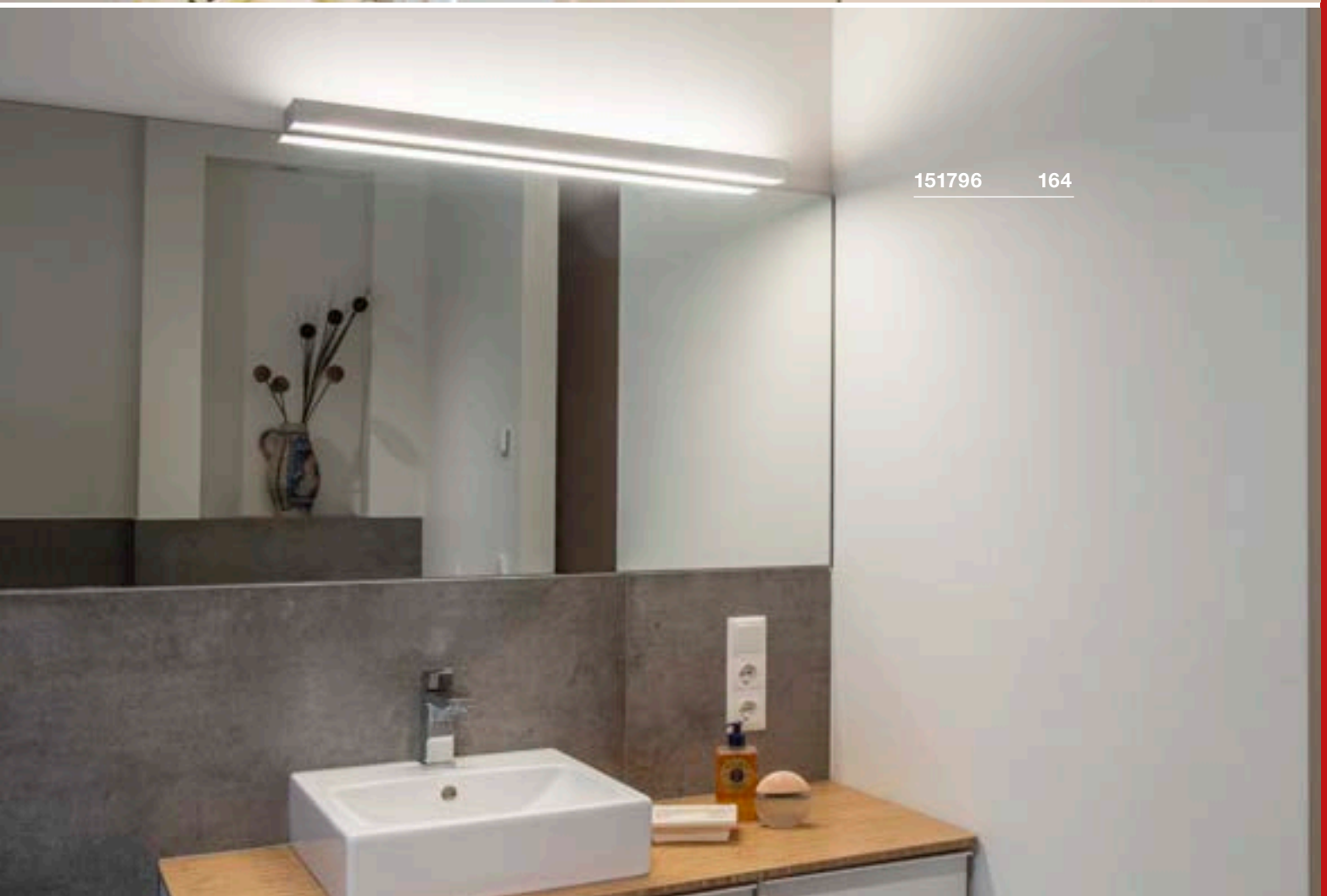

151796 164

ASSO 70
WL



Produktangaben

100-240V ~50/60Hz | 500mA
Systemleistung: 7,6W
Material: Aluminium / Stahl

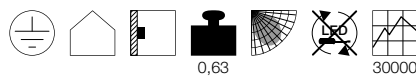

Maßzeichnung

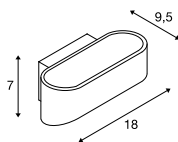

Variante	Art. Nr.
350lm 3000K CRI>80 □ weiß	151311
350lm 3000K CRI>80 ■ matt aluminium / weiß	151315

ASSO 300
WL

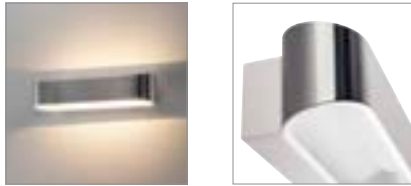

Produktangaben

220-240V ~50/60Hz | 500mA
Systemleistung: 12W
Material: Aluminium / Stahl



Maßzeichnung

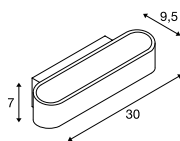

Variante	Art. Nr.
700lm 3000K CRI>80 □ weiß	151271
700lm 3000K CRI>80 ■ matt aluminium / weiß	151275

ASSO 300
WL

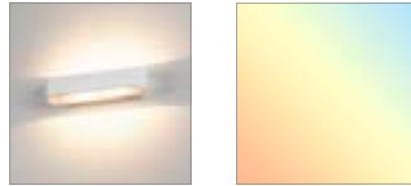
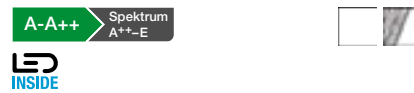

Produktangaben

220-240V ~50/60Hz | 500mA
Systemleistung: 22W
Material: Aluminium / Stahl
Dimmbar: Triac C, Triac L

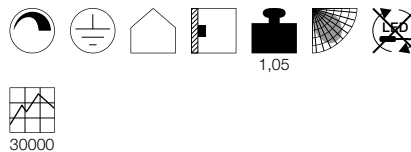

Maßzeichnung

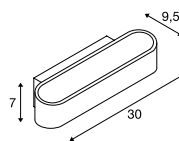

Variante	Art. Nr.
1040lm 2000-3000K CRI>90 □ weiß	1000634
1040lm 2000-3000K CRI>90 ■ matt aluminium / weiß	1000635

ASSO
WL



Produktangaben

220-240V ~50/60Hz | 250mA
Systemleistung: 12W
Material: Aluminium / Stahl
Dimmbar: Triac C

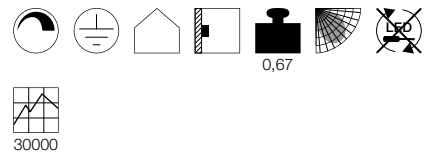

Maßzeichnung

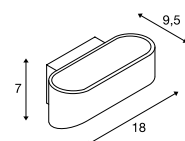

Variante	Art. Nr.
530lm 2000-3000K CRI>90 □ weiß	1000636
530lm 2000-3000K CRI>90 ■ matt aluminium / weiß	1000637

OSSA 180
WL, QT-DE12



OSSA 300
WL, QT-DE12

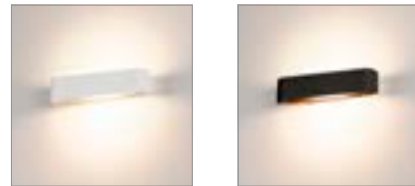

Produktangaben

230V ~50Hz
Material: Aluminium / Stahl

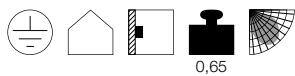

0,65

Maßzeichnung

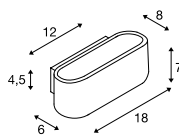

Produktangaben

230V ~50Hz
Material: Aluminium / Stahl

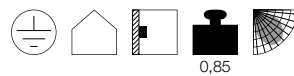

0,85

Maßzeichnung

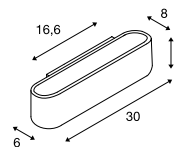

Leuchtmittlempfehlung

R7s 78mm 5,5W 330°
3000K 530lm EEK=A+
6kWh/1000h
Art. Nr. 560332



Leuchtmittelangaben

max. 100W QT-DE12

Variante	Art. Nr.
R7s 78mm QT-DE12	
■ schwarz	151450
R7s 78mm QT-DE12	
□ weiß	151451
R7s 78mm QT-DE12	
▒ matt aluminium	151456

Leuchtmittlempfehlung

R7s 118mm 10,5W 330°
3000K 1050lm EEK=A+
11kWh/1000h
Art. Nr. 560352



LED R7s 118mm 14W
3000K 2000lm EEK=A++
14kWh/1000h
Art. Nr. 1002135



Leuchtmittelangaben

max. 120W QT-DE12

Variante	Art. Nr.
R7s 118mm QT-DE12	
■ schwarz	151410
R7s 118mm QT-DE12	
□ weiß	151411
R7s 118mm QT-DE12	
▒ matt aluminium / weiß	151416





1002239 169

ARLINA 60/130
WL

A-A++ Spektrum
A++-E

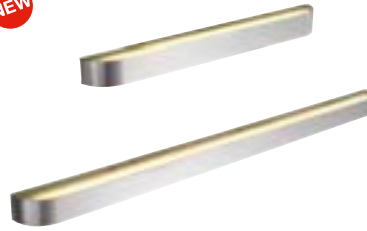

Produktangaben

220-240V ~50/60Hz | 500mA
Material: Aluminium / Glas
Produktmaße: B: 6,8 cm H: 6 cm

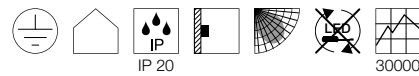

ARLINA 60/130
WL, T16

A-A+ Spektrum
A++-E

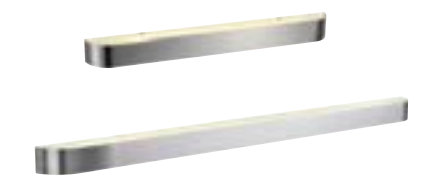

Produktangaben

220-240V ~50/60Hz
Systemleistung: 31,5W
Material: Aluminium

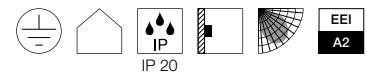

Maßzeichnung

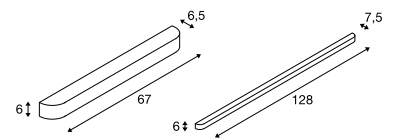

Leuchtmittelempfehlung

LED G5 28W
3000K 2600lm EEK=A+
44kWh/1000h
Art. Nr. 548028

Leuchtmittelangaben

28W T16



155216 169

Variante	Art. Nr.
1400lm 3000K CRI>80 20W L: 67 cm 2,2 kg aluminium	1002239
2400lm 3000K CRI>80 28W L: 128 cm 3,9 kg aluminium	1002240

Variante	Art. Nr.
G5 T16 L: 67 cm 2,2 kg aluminium	155206
G5 T16 L: 128 cm 3,8 kg aluminium	155216

PLASTRA
WL, curve



A-A++ Spektrum
A++-E



• Hochvolt LED

Produktangaben

230V ~50Hz
Systemleistung: 19W
Material: Gips / Glas
Dimmbar: Triac C, Triac L

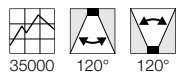
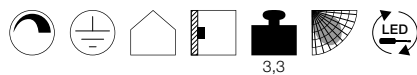

Maßzeichnung

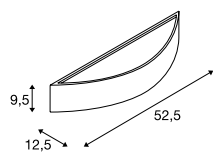

148062 170

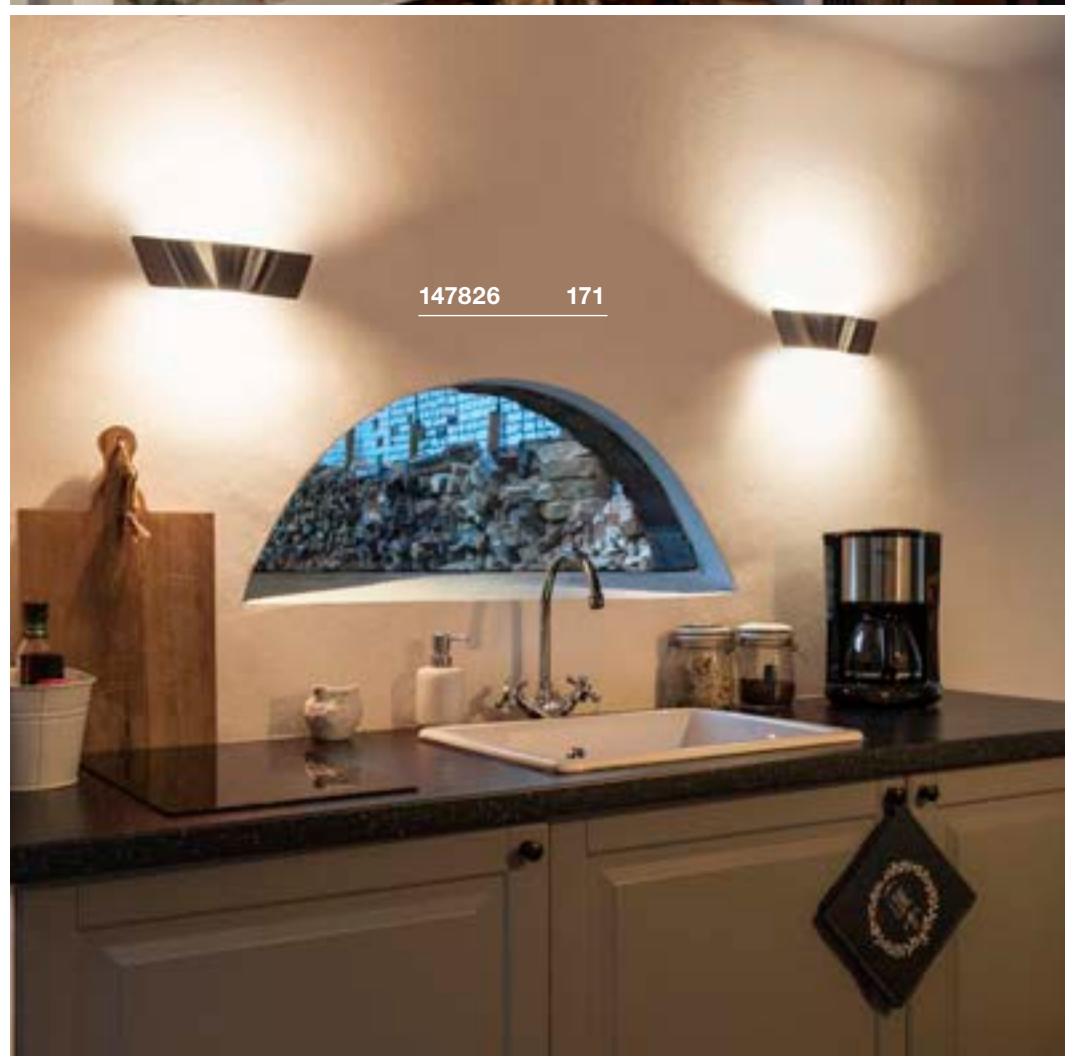

147826 171

Variante	Art. Nr.
Up: 520lm 3000K CRI>80	
Down: 520lm 3000K CRI>80	
□ weiß / matt transparent	148062

WAVE 25
WL



A-A++ Spektrum A++-E

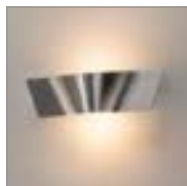

WAVE 45
WL



A-A++ Spektrum A++-E

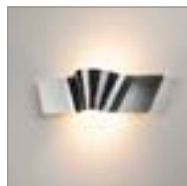

- Premium LED mit CRI>90

WAVE 45
WL



A-A++ Spektrum A++-E

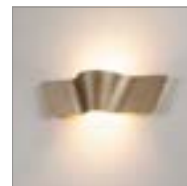

- Premium LED mit CRI>90
- Dim to Warm
- Beim Dimmen ändert sich die Lichtfarbe

Produktangaben

220-240V ~50/60Hz | 500mA
Systemleistung: 11,5W
Material: Aluminium
Dimmbar: Triac C, Triac L

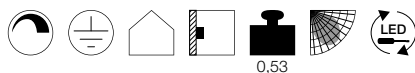

0,53



40000

Maßzeichnung

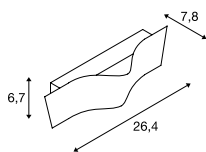

Produktangaben

220-240V ~50/60Hz | 500mA
Systemleistung: 21W
Material: Aluminium
Dimmbar: Triac C, Triac L

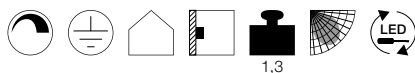

1,3



30000

Maßzeichnung

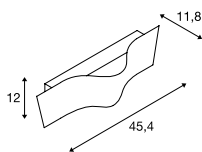

Produktangaben

220-240V ~50/60Hz | 500mA
Systemleistung: 22W
Material: Aluminium / Stahl
Dimmbar: Triac C, Triac L

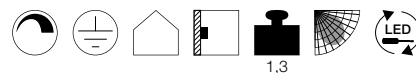

1,3



30000

Maßzeichnung

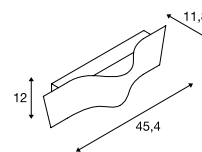

Variante	Art. Nr.
830lm 3000K CRI>80	
weiß	147821
700lm 3000K CRI>80	
gold	147823
830lm 3000K CRI>80	
matt aluminium	147826

Variante	Art. Nr.
1400lm 3000K CRI>90	
weiß	147841
1300lm 3000K CRI>90	
gold	147843
1400lm 3000K CRI>90	
matt aluminium	147846

Variante	Art. Nr.
1050lm 2000-3000K CRI>90	
weiß	1000650
900lm 2000-3000K CRI>90	
gold	1000651
1050lm 2000-3000K CRI>90	
aluminium / weiß	1000652

CARISO
WL

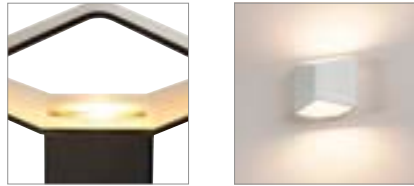

- Die unterschiedlichen Leuchteninnenfarben führen zu Unterschiedlichen Lichtfarben

Produktangaben

220-240V ~50/60Hz | 500mA
Systemleistung: 11W
Material: Aluminium / Stahl
Dimmbar: Triac C, Triac L

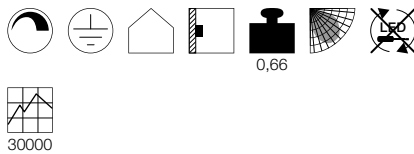

Maßzeichnung

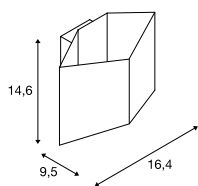

CARISO
WL

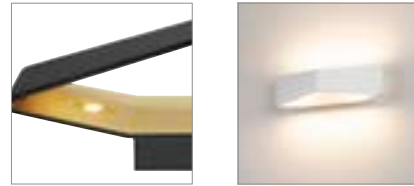
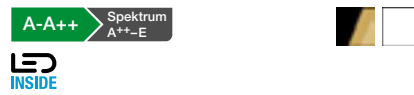

- Premium LED mit CRI>90
- Die unterschiedlichen Leuchteninnenfarben führen zu Unterschiedlichen Lichtfarben

Produktangaben

220-240V ~50/60Hz | 500mA
Systemleistung: 22W
Material: Aluminium / Stahl
Dimmbar: Triac C, Triac L

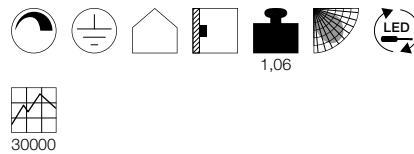

Maßzeichnung

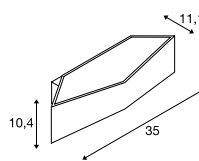

Variante	Art. Nr.
200lm 2700K CRI>90	
■ schwarz / gold	151710
390lm 3000K CRI>90	
□ weiß	151711

Variante	Art. Nr.
500lm 1700-2700K CRI>90	
■ schwarz / gold	151740
900lm 2000-3000K CRI>90	
□ weiß	151741



151610 173

LED SAIL
WL



A-A++ Spektrum
A++-E



Produktangaben

100-240V ~50/60Hz | 700mA
Systemleistung: 3,5W
Material: Aluminium / Stahl

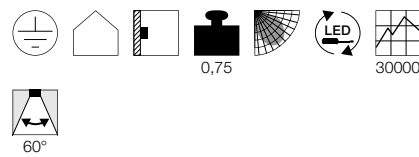

Maßzeichnung

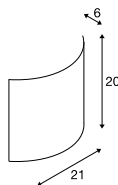

Variante	Art. Nr.
110lm 3000K CRI>80	
■ schwarz	151600
140lm 3000K CRI>80	
□ weiß	151601

LED SAIL
WL



A-A++ Spektrum
A++-E



Produktangaben

100-240V ~50/60Hz | 700mA
Systemleistung: 6W
Material: Aluminium / Stahl

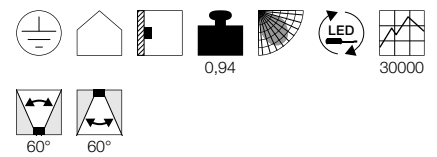

Maßzeichnung

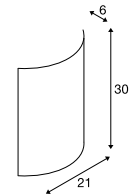

Variante	Art. Nr.
Up: 85lm 3000K CRI>80	
Down: 85lm 3000K CRI>80	
■ schwarz	151610
Up: 120lm 3000K CRI>80	
Down: 120lm 3000K CRI>80	
□ weiß	151611

PLASTRA UP/DOWN
WL, curve

893

A-A++ Spektrum
A++-E

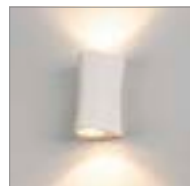

- Individuell gestaltbar mit Farben, Stickern & mehr

Produktangaben

220-240V ~50/60Hz | 700mA
Systemleistung: 6,6W
Material: Gips / Stahl
Dimmbar: Triac C, Triac L

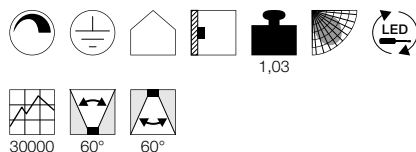

Maßzeichnung

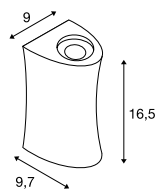

PLASTRA 104
WL, QT14

893

D-A+ Spektrum
A++-E

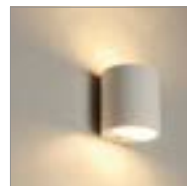

- Individuell gestaltbar mit Farben, Stickern & mehr

Produktangaben

230V ~50Hz
Material: Gips / Stahl

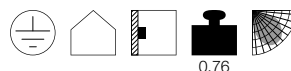

Maßzeichnung

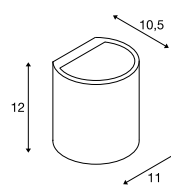

Leuchtmittlempfehlung

G9 2,5W
2700K 180lm EEK=A+
3kWh/1000h
Art. Nr. 560302



LED G9 3,5W
2800K 300lm EEK=A+
4kWh/1000h
Art. Nr. 1002131



Leuchtmittelangaben

max. 42W QT14

Variante	Art. Nr.
Up: 125lm 3000K CRI>80 Down: 125lm 3000K CRI>80 <input type="checkbox"/> weiß	1001271

Variante	Art. Nr.
G9 QT14 <input type="checkbox"/> weiß	148016

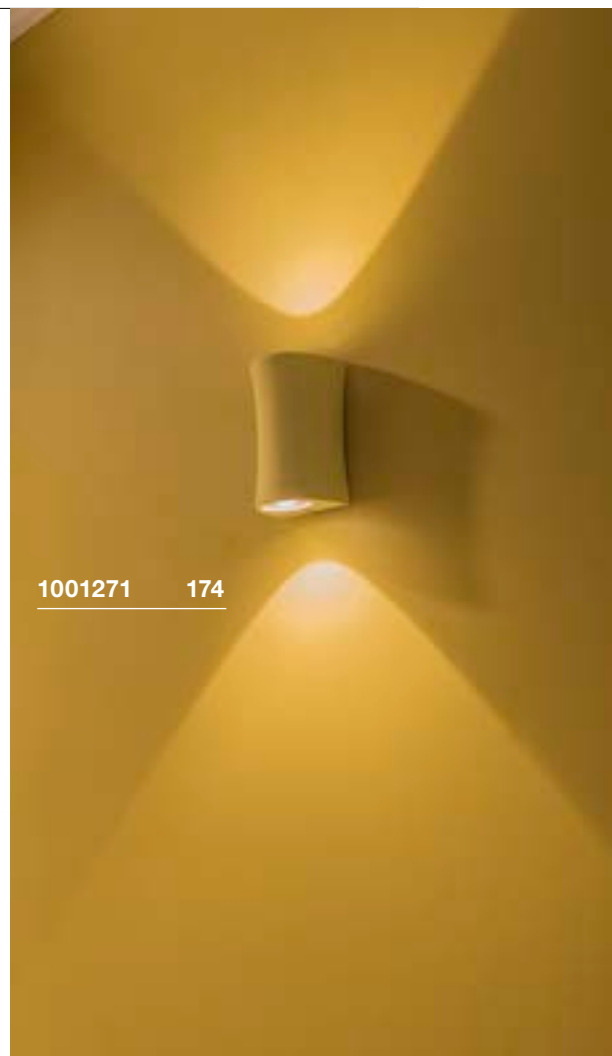

1001271 174

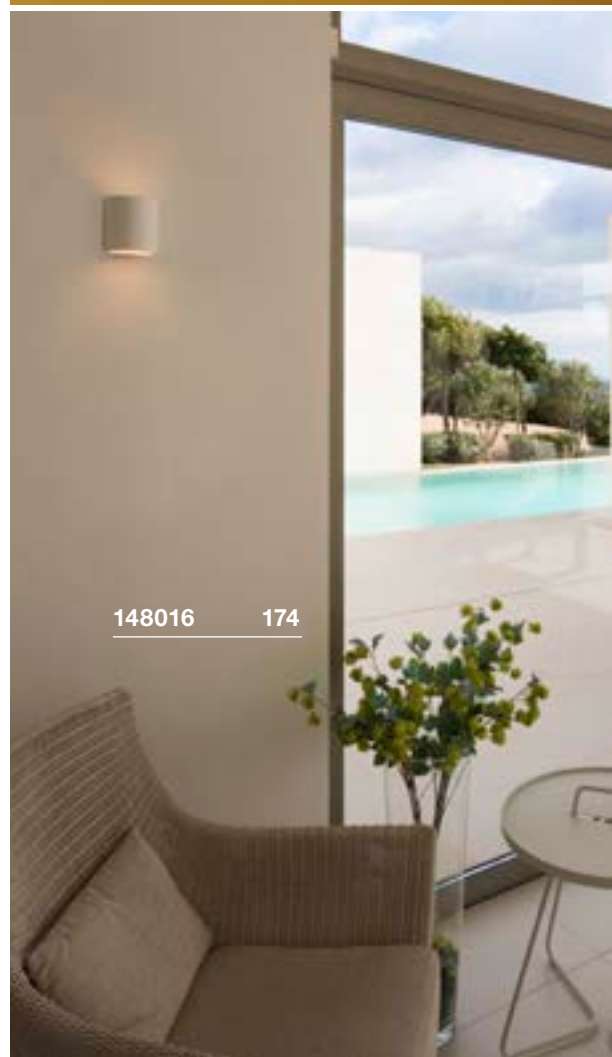

148016 174



148060 175

PLASTRA
WL, QPAR51

893

E-A++ Spektrum
A++-E

- Individuell gestaltbar mit Farben, Stickers & mehr

Produktangaben

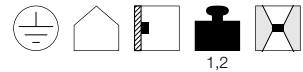
220-240V ~50/60Hz
Material: Gips / Stahl

1,2

Maßzeichnung

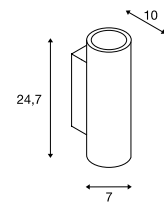

Leuchtmittlempfehlung

LED GU10 7,2W 36°
2700K 570lm EEK=A+
8kWh/1000h
Art. Nr. 560542LED GU10 7,2W 36°
3000K 520lm EEK=A+
8kWh/1000h
Art. Nr. 1001561

Leuchtmittelangaben

2x max. 35W QPAR51

Variante	Art. Nr.
GU10 QPAR51	
<input type="checkbox"/> weiß	148060

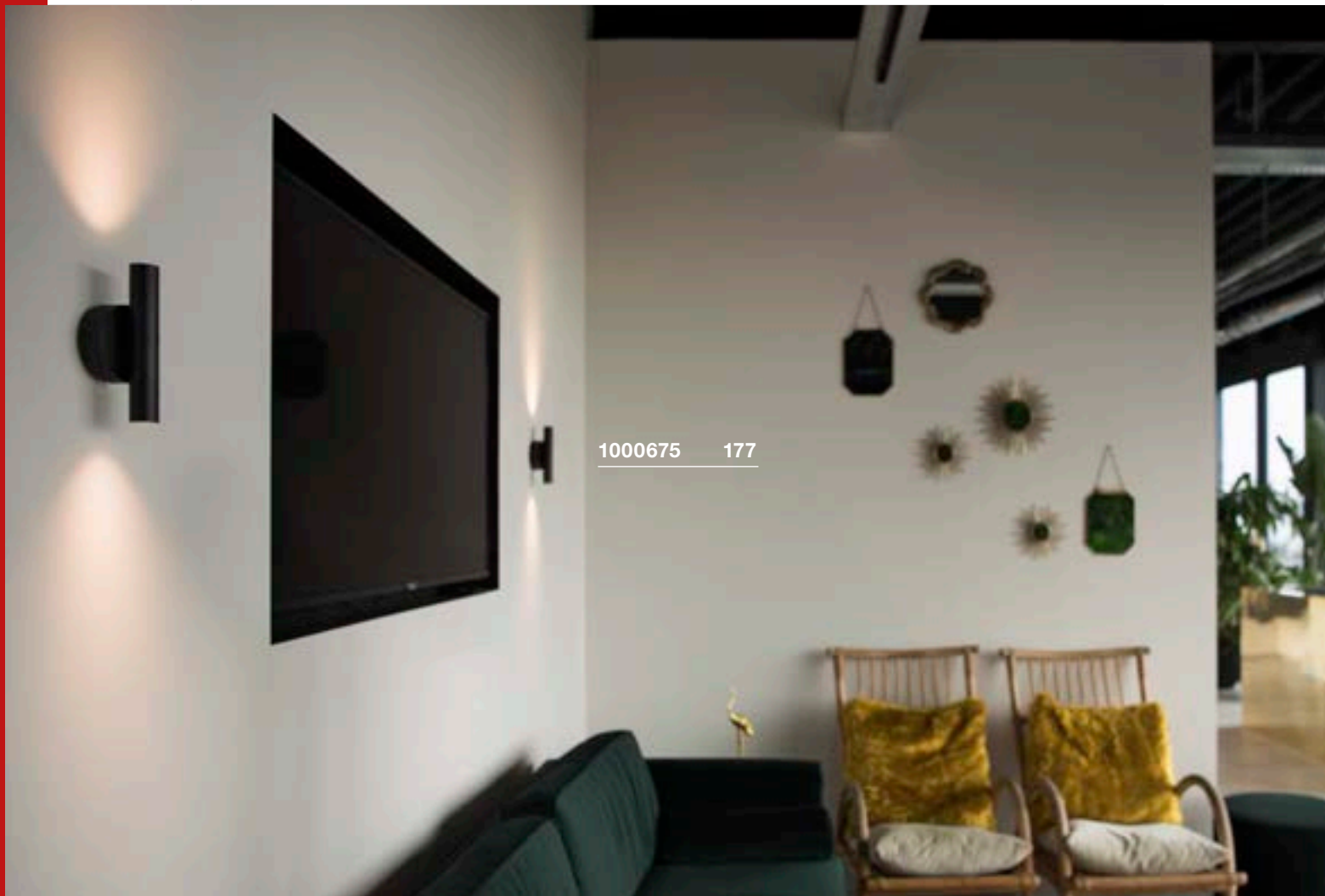

1000675 177

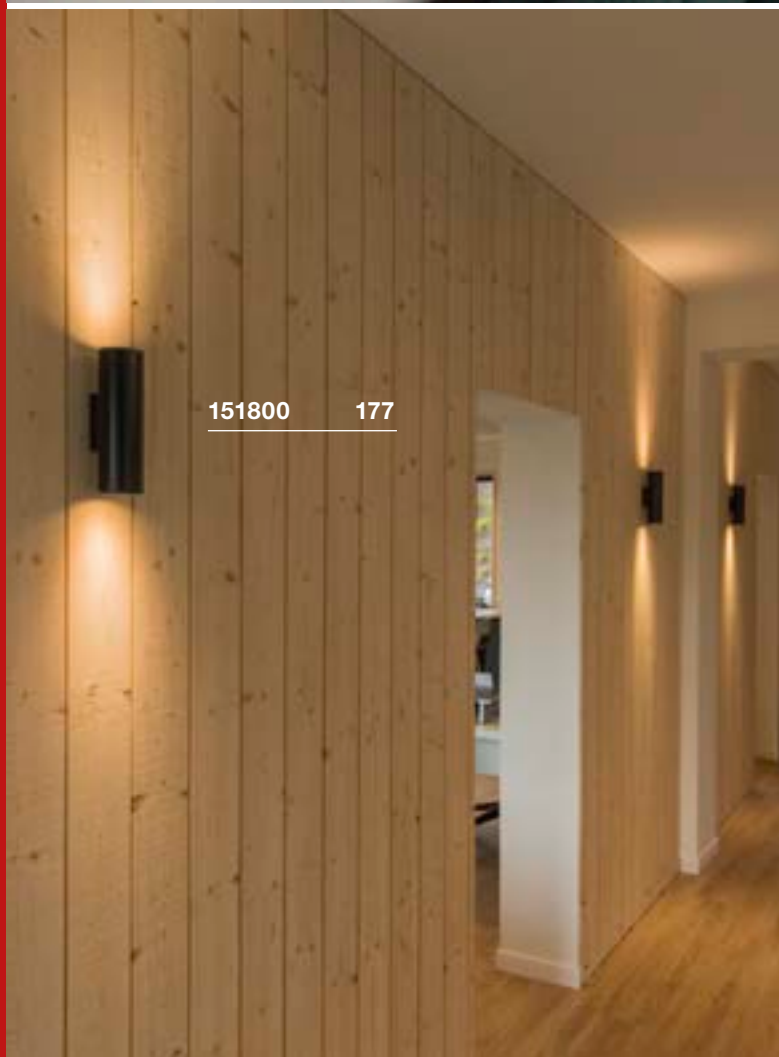

151800 177

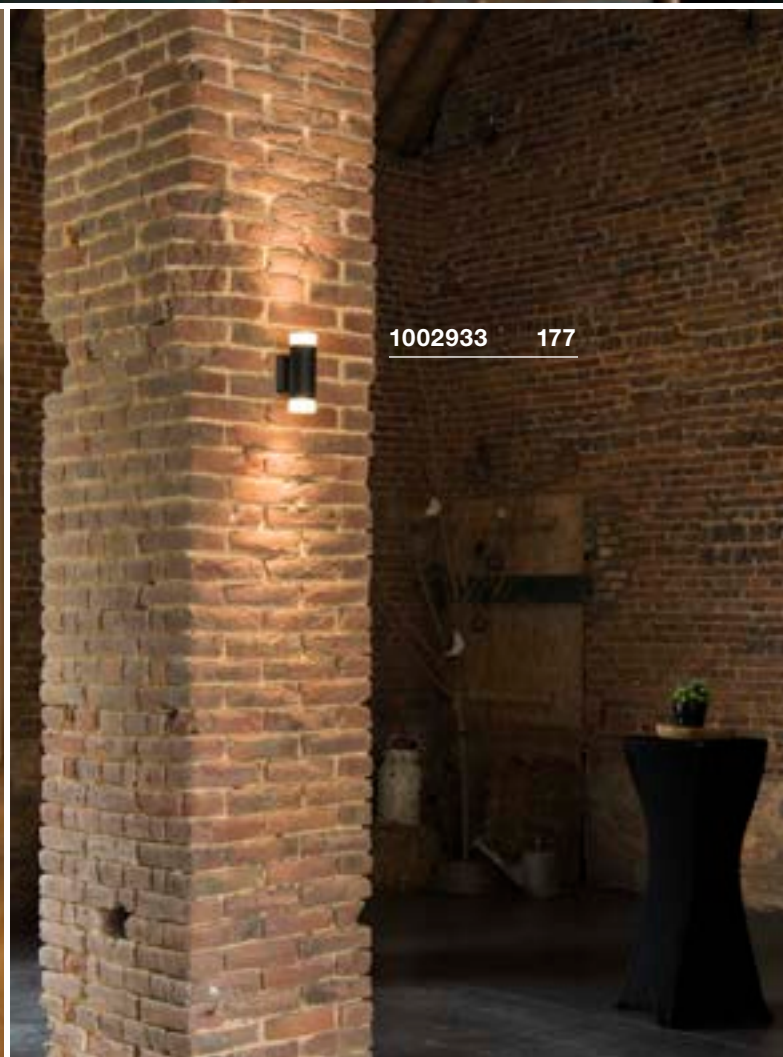

1002933 177

KARPO UP/DOWN WL

889

A-A++ Spektrum A++-E



- Premium LED mit CRI>90

Produktangaben

100-240V ~50/60Hz | 450mA
Systemleistung: 10W
Material: Aluminium

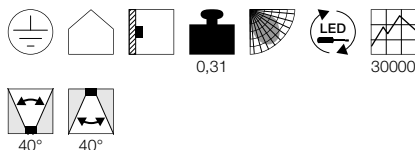

Maßzeichnung

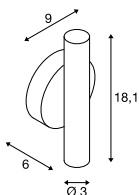

Variante	Art. Nr.
Up: 320lm 3000K CRI>90 Down: 320lm 3000K CRI>90	
■ schwarz	1000675
Up: 370lm 3000K CRI>90 Down: 370lm 3000K CRI>90	
□ weiß	1000676
Up: 340lm 3000K CRI>90 Down: 340lm 3000K CRI>90	
■ gold	1002174

ENOLA B WL, QPAR51

885

E-A++ Spektrum A++-E



Produktangaben

230V ~50Hz
Material: Aluminium / Stahl

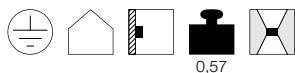

Maßzeichnung

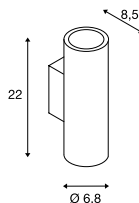

Zubehörempfehlung

■ Zierring
Art. Nr. 151840

Leuchtmittlempfehlung

LED GU10 7,2W 36°
2700K 570lm EEK=A+
8kWh/1000h
Art. Nr. 560542

LED GU10 7,2W 36°
3000K 520lm EEK=A+
8kWh/1000h
Art. Nr. 1001561

Leuchtmittelangaben

2x max. 50W QPAR51
L: 8,5 cm max.

Variante	Art. Nr.
GU10 QPAR51	
■ schwarz	151800
GU10 QPAR51	
□ weiß	151801
GU10 QPAR51	
■ gold	151803
GU10 QPAR51	
■ grau / schwarz	151804

ASTINA UP/DOWN WL, QPAR51

884

A-A++ Spektrum A++-E



- Hochwertiges, satiniertes Glas

Produktangaben

220-240V ~50/60Hz
Material: Aluminium / Stahl

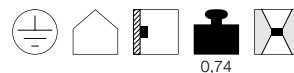

Maßzeichnung

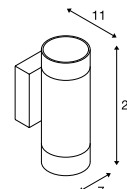

Leuchtmittelangaben

2x max. 10W QPAR51

Variante	Art. Nr.
GU10 QPAR51	
□ matt weiß / matt weiß	1002931
GU10 QPAR51	
■ matt grau / matt grau	1002932
GU10 QPAR51	
■ matt schwarz / matt schwarz	1002933

ROX
WL, QPAR111



E-A++ Spektrum A++-E



- Hochwertig gebürstete Oberfläche

Produktangaben

230V ~50Hz
Material: Aluminium / Glas

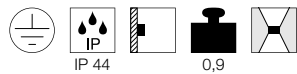

Maßzeichnung

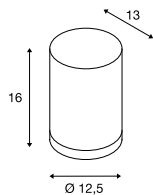

Leuchtmittlempfehlung

LED GU10 10W 38°
3000K 630lm EEK=A+
10kWh/1000h
Art. Nr. 1001029



LED GU10 13W 30°
4000K 1300lm EEK=A+
13kWh/1000h
Art. Nr. 1001243



Leuchtmittelangaben

max. 50W QPAR111

Variante	Art. Nr.
GU10 QPAR111	
gebürstet aluminium	1000333

ROX UP/DOWN
WL, QPAR111



E-A++ Spektrum A++-E



- Hochwertig gebürstete Oberfläche

Produktangaben

230V ~50Hz
Material: Aluminium / Glas

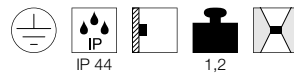

Maßzeichnung

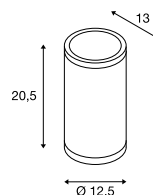

Leuchtmittlempfehlung

LED GU10 10W 38°
3000K 630lm EEK=A+
10kWh/1000h
Art. Nr. 1001029



LED GU10 13W 30°
4000K 1300lm EEK=A+
13kWh/1000h
Art. Nr. 1001243



Leuchtmittelangaben

2x max. 50W QPAR111

Variante	Art. Nr.
GU10 QPAR111	
gebürstet aluminium	1000334



1000334 178

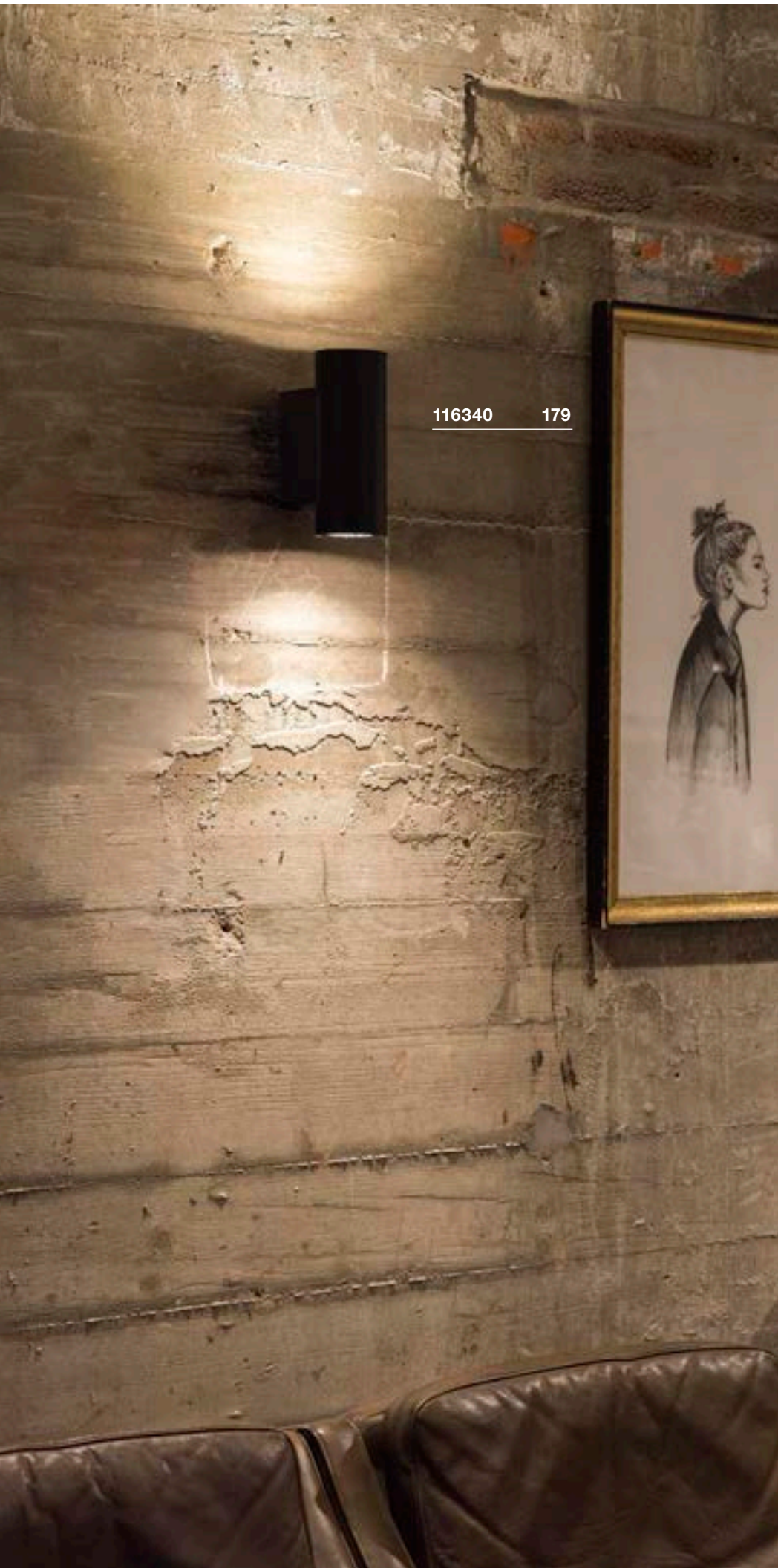

116340 179

SUPROS 78 UP/DOWN WL  897A-A++ Spektrum
A++-ELED
INSIDE

Produktangaben

220-240V ~50/60Hz | 250mA
 Systemleistung: 24W
 Material: Aluminium
 Dimmbar: Triac C, Triac L

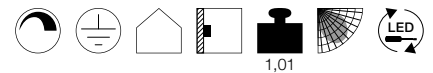

1,01

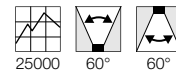

25000 60° 60°

Maßzeichnung

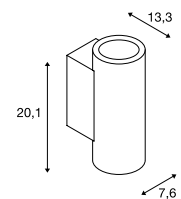

Zubehörempfehlung

Linse 20°

Art. Nr. 116302 

Linse 40°

Art. Nr. 116304 

Variante

Art. Nr.

Up: 700lm | 3000K | CRI>80

Down: 700lm | 3000K | CRI>80

■ schwarz 116340

Up: 700lm | 3000K | CRI>80

Down: 700lm | 3000K | CRI>80

□ weiß 116341

PLASTRA 101
WL, E14



E-A++ Spektrum A++-E



- Individuell gestaltbar mit Farben, Stickern & mehr

Produktangaben

230V ~50Hz
Material: Gips / Stahl

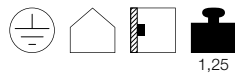

Maßzeichnung

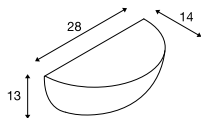

Leuchtmittlempfehlung

LED E14 6,5W 280°
3000K 480lm EEK=A+
7kWh/1000h
Art. Nr. 560372



LED E14 4W
2700K 250lm EEK=A+
4kWh/1000h
Art. Nr. 560222



Leuchtmittelangaben

max. 40W C35
Ø: 4,5 cm max. L: 11 cm max.

Variante	Art. Nr.
E14 C35	
□ weiß	148013

PLASTRA
WL, Curve, QT-DE12



D-A+ Spektrum A++-E

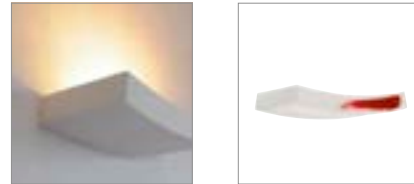

- Individuell gestaltbar mit Farben, Stickern & mehr

Produktangaben

230V ~50Hz
Material: Gips / Stahl

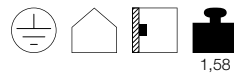

Maßzeichnung

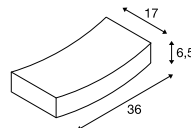

Leuchtmittlempfehlung

R7s 78mm 5,5W 330°
3000K 530lm EEK=A+
6kWh/1000h
Art. Nr. 560332



Leuchtmittelangaben

max. 100W QT-DE12

Variante	Art. Nr.
R7s 78mm QT-DE12	
□ weiß	148012

PLASTRA
WL, cone, TCR-TSE



B-A++ Spektrum A++-E



- Individuell gestaltbar mit Farben, Stickern & mehr

Produktangaben

230V ~50Hz
Material: Gips / Stahl

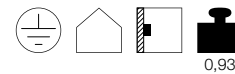

Maßzeichnung

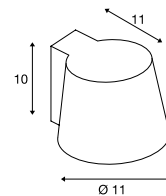

Leuchtmittlempfehlung

GX53 4,2W 35°
3000K 200lm EEK=A
5kWh/1000h
Art. Nr. 550092



LED GX53 7,5W 120°
4000K 620lm EEK=A+
8kWh/1000h
Art. Nr. 1001221



Leuchtmittelangaben

max. 11W TCR-TSE

Variante	Art. Nr.
GX53 TCR-TSE	
□ weiß	148061



148061 180



148013 180

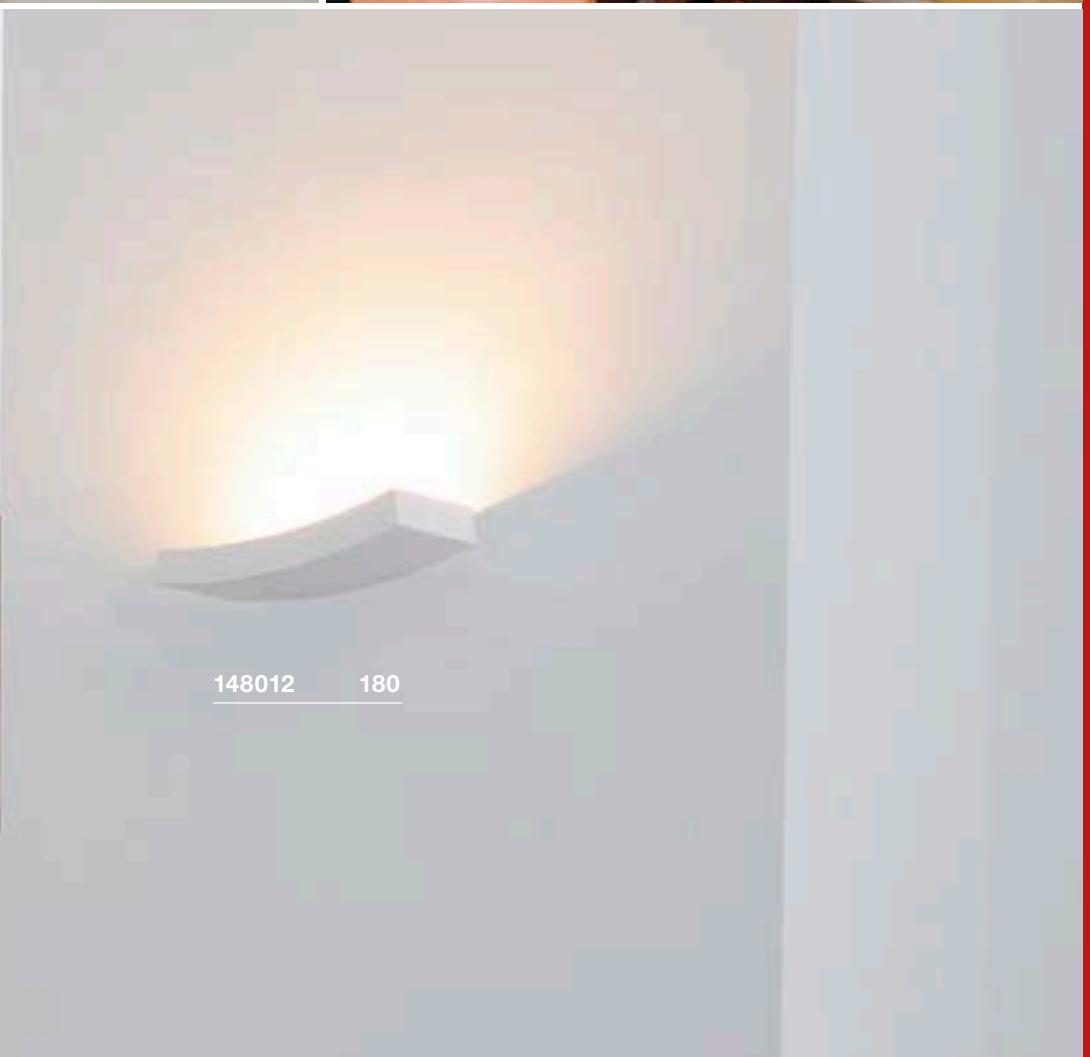
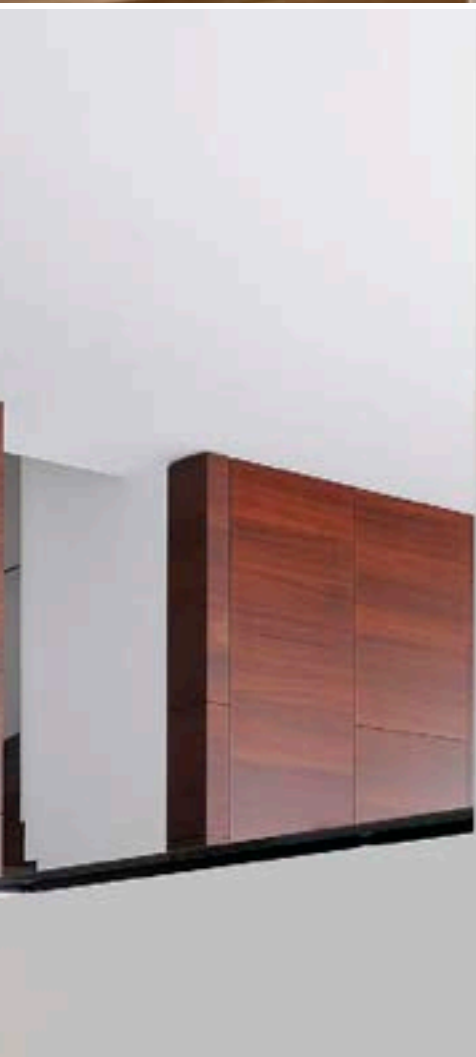

148012 180



1000340 183

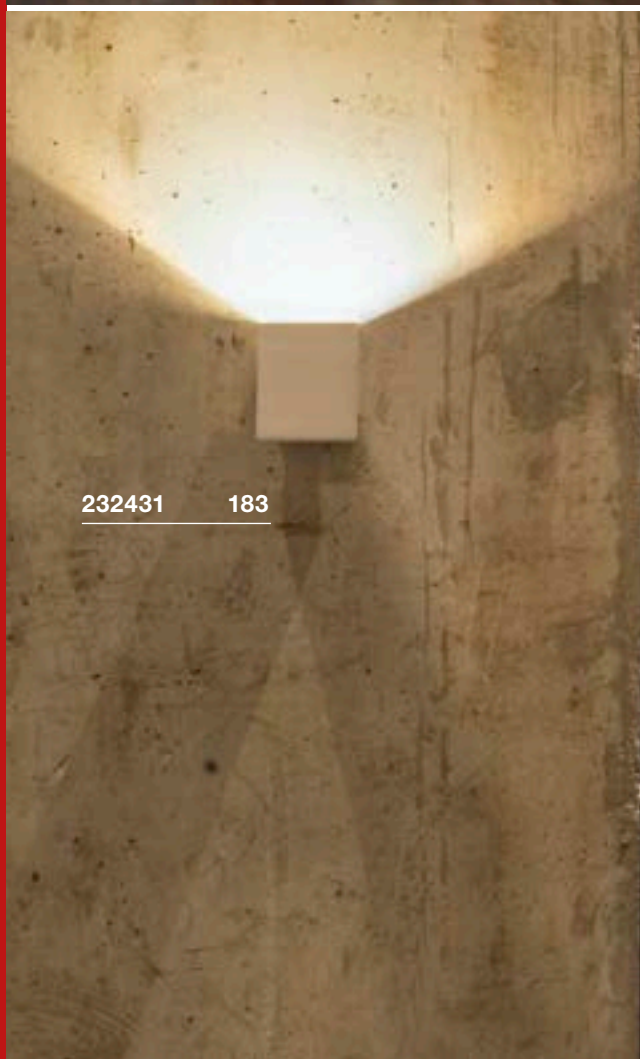
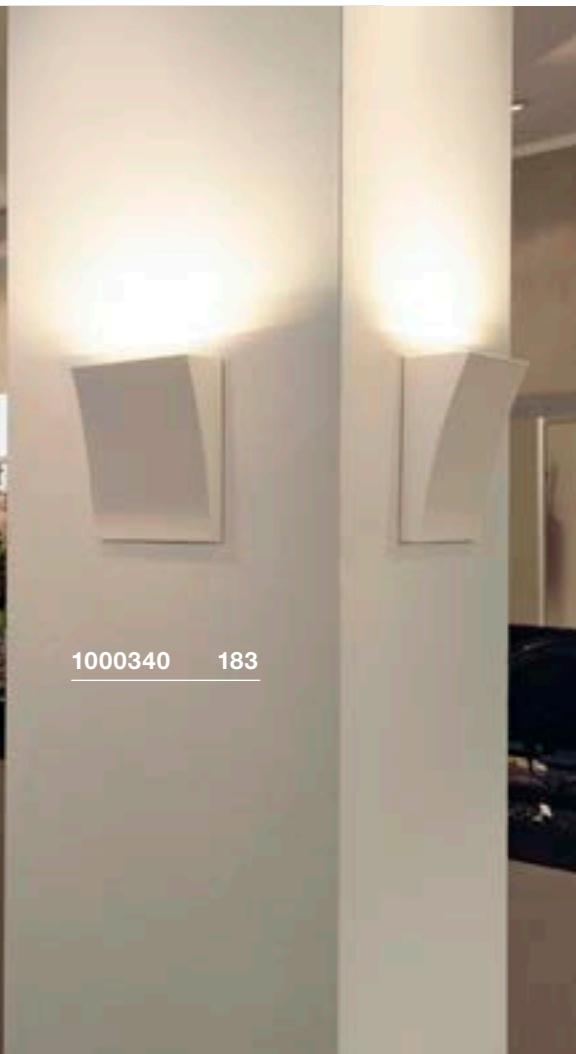

232431 183



DELWA
WL

A-A++ Spektrum A++-E

LED INSIDE



Produktangaben

100-240V ~50/60Hz | 700mA
Systemleistung: 10W
Material: Aluminium / Glas

IP 44 0,8 30000 100° 0,2

Maßzeichnung

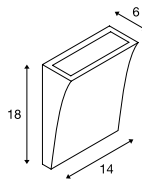

Variante	Art. Nr.
910lm 3000K CRI>80 □ weiß	1000340
910lm 3000K CRI>80 ■ grau	1000341
910lm 3000K CRI>80 ■ anthrazit	1000342

QUAD
WL



A-A++ Spektrum A++-E

LED INSIDE



Produktangaben

200-240V ~50/60Hz | 700mA
Systemleistung: 4,6W
Material: Aluminium / Glas

IP 44 0,25 30000 90°

Maßzeichnung

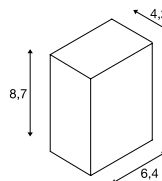

Variante	Art. Nr.
100lm 3000K CRI>80 □ weiß	232461
80lm 3000K CRI>80 ■ anthrazit	232465

BIG QUAD
WL

A-A++ Spektrum A++-E

LED INSIDE

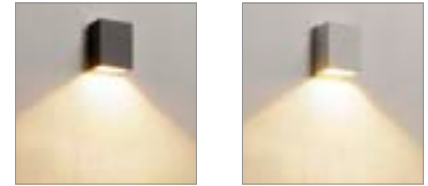

Produktangaben

100-277V ~50/60Hz | 350mA
Systemleistung: 4,5W
Material: Aluminium / Glas

IP 44 0,63 30000 110°

Maßzeichnung

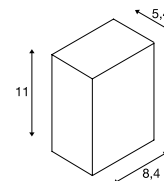

Variante	Art. Nr.
290lm 3000K CRI>80 □ weiß	232431
260lm 3000K CRI>80 ■ anthrazit	232435

PEMA®
WL

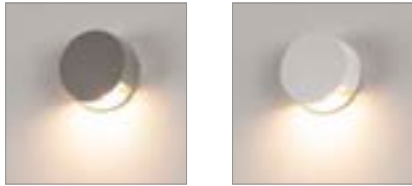

Produktangaben

230V ~50Hz
Systemleistung: 4,7W
Material: Aluminium / Glas



Maßzeichnung

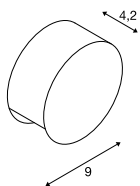

Hinweis

Schutzart IP44 nur bei Montage mit Lichtaustritt nach unten.

LYNAH
WL



- Leuchtenmodul kardanischn drehbar. 180° schwenkbar.

Produktangaben

220-240V ~50/60Hz | 350mA
Systemleistung: 14W
Material: Aluminium / Polycarbonat (PC)
Dimmbar: Triac C

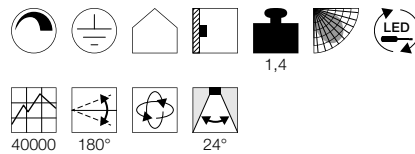

Maßzeichnung

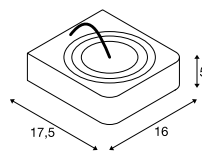

Variante	Art. Nr.
125lm 3000K CRI>80 □ weiß	231010
125lm 3000K CRI>80 ■ grau	231012
125lm 3000K CRI>80 ■ anthrazit	231015

Variante	Art. Nr.
950lm 3000K CRI>80 ■ schwarz	1000414
950lm 3000K CRI>80 □ weiß	1000415



1000414 184



231012 184

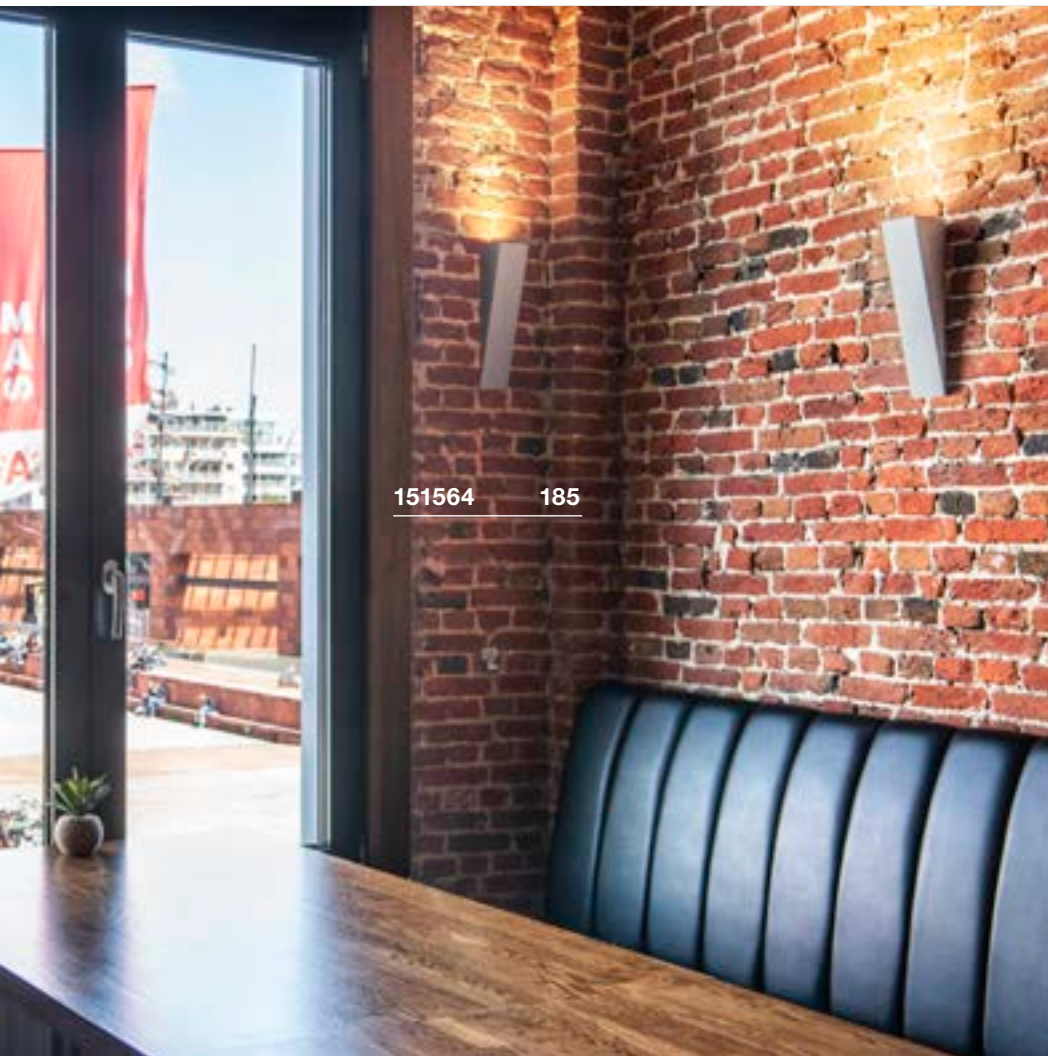

151564 185

ALTRA DICE
WL, QPAR51

883

E-A++ Spektrum A++-E



Produktangaben

220-240V ~50/60Hz
Material: Aluminium / Stahl

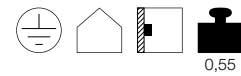

Maßzeichnung

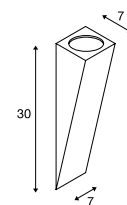

Leuchtmittlempfehlung

GU10 5,5W 36°
2800K 420lm EEK=A+
6kWh/1000h
Art. Nr. 1001217



LED GU10 5,5W 38°
2700K 400lm EEK=A+
6kWh/1000h
Art. Nr. 1001030



Leuchtmittelangaben

max. 50W QPAR51

Variante	Art. Nr.
GU10 QPAR51 □ weiß	151561
GU10 QPAR51 ■ grau	151564
GU10 QPAR51 ■ schwarz	1002213

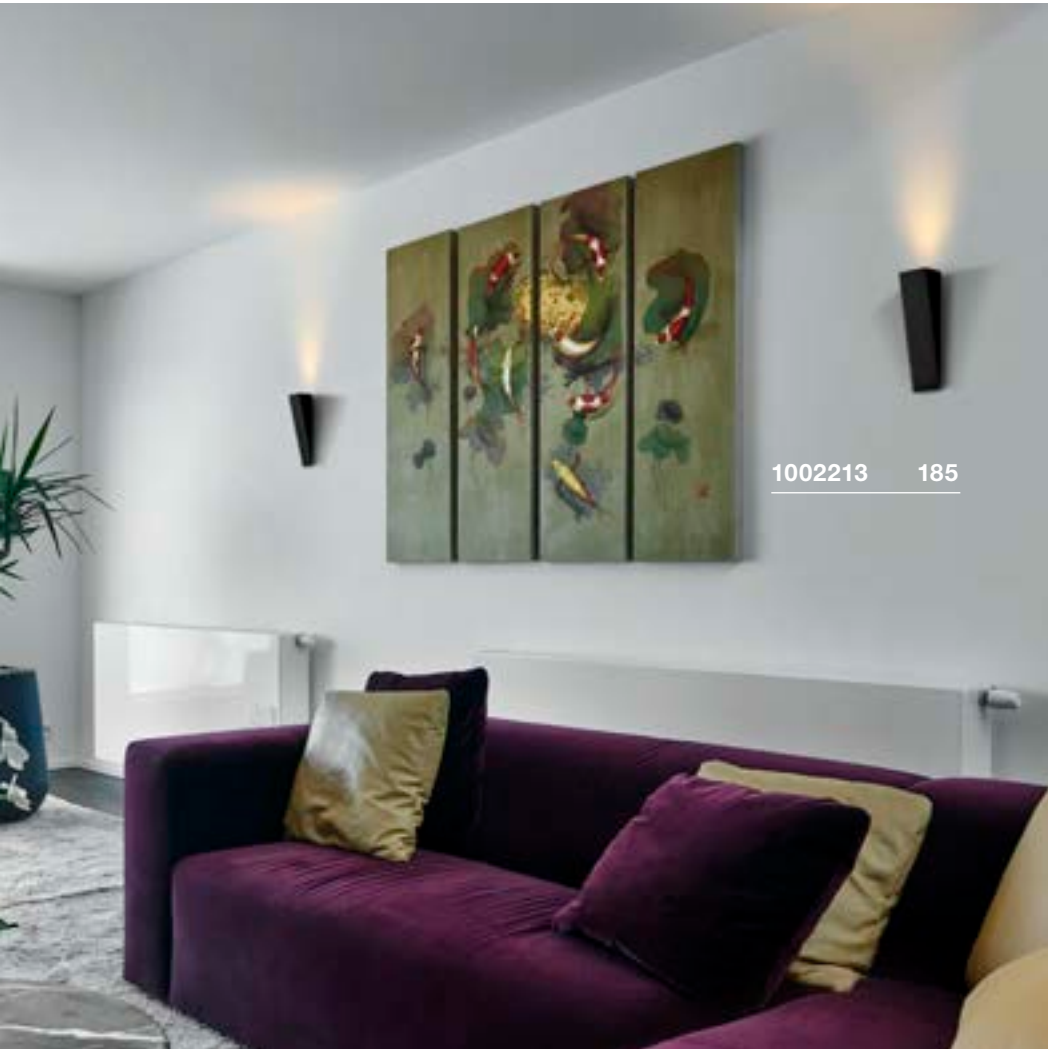

1002213 185

SHELL 15
WL, TRIAC

A-A++ Spektrum A++-E



• Indirekte Beleuchtung

Produktangaben

220-240V ~50/60Hz | 350mA
Systemleistung: 15W
Material: Aluminium / Acryl
Dimmbar: Triac C, Triac L

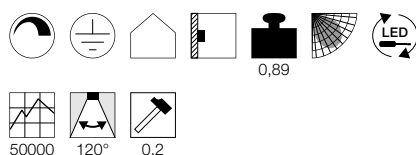

Maßzeichnung

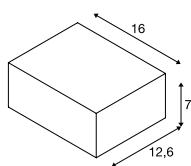

SHELL 30
WL, TRIAC

A-A++ Spektrum A++-E



• Indirekte Beleuchtung

Produktangaben

220-240V ~50/60Hz | 700mA
Systemleistung: 54W
Material: Aluminium / Acryl
Dimmbar: Triac C

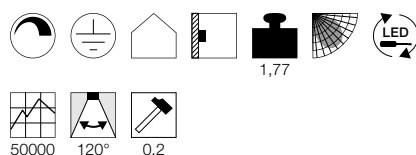

Maßzeichnung

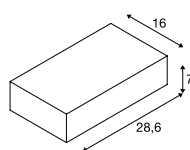

1000423 186

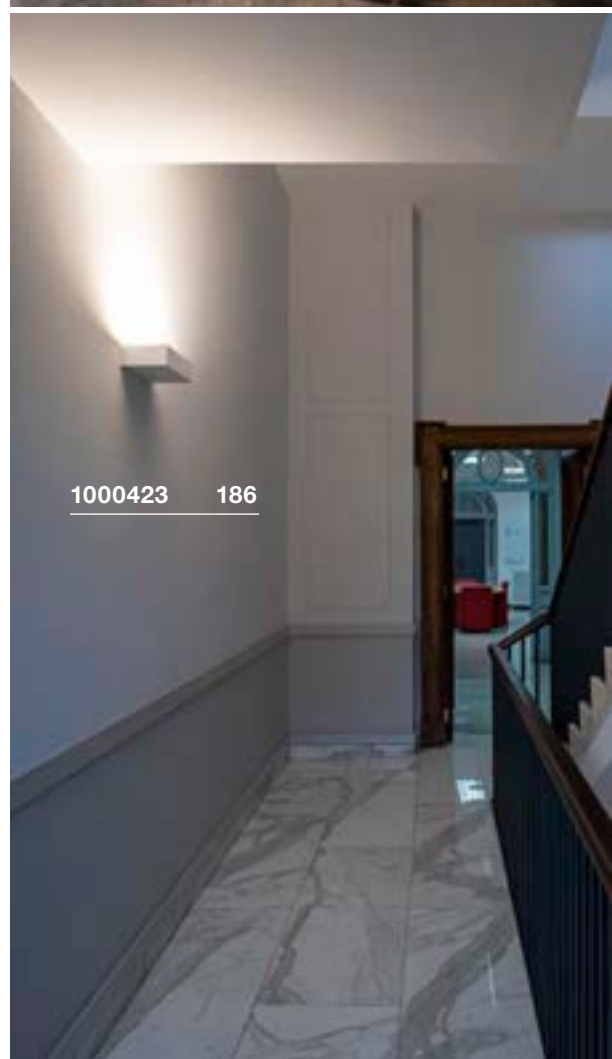

1000423 186

Variante	Art. Nr.
1400lm 3000K CRI>80 □ weiß	1000422

Variante	Art. Nr.
5600lm 3000K CRI>80 □ weiß	1000423



1000422 186

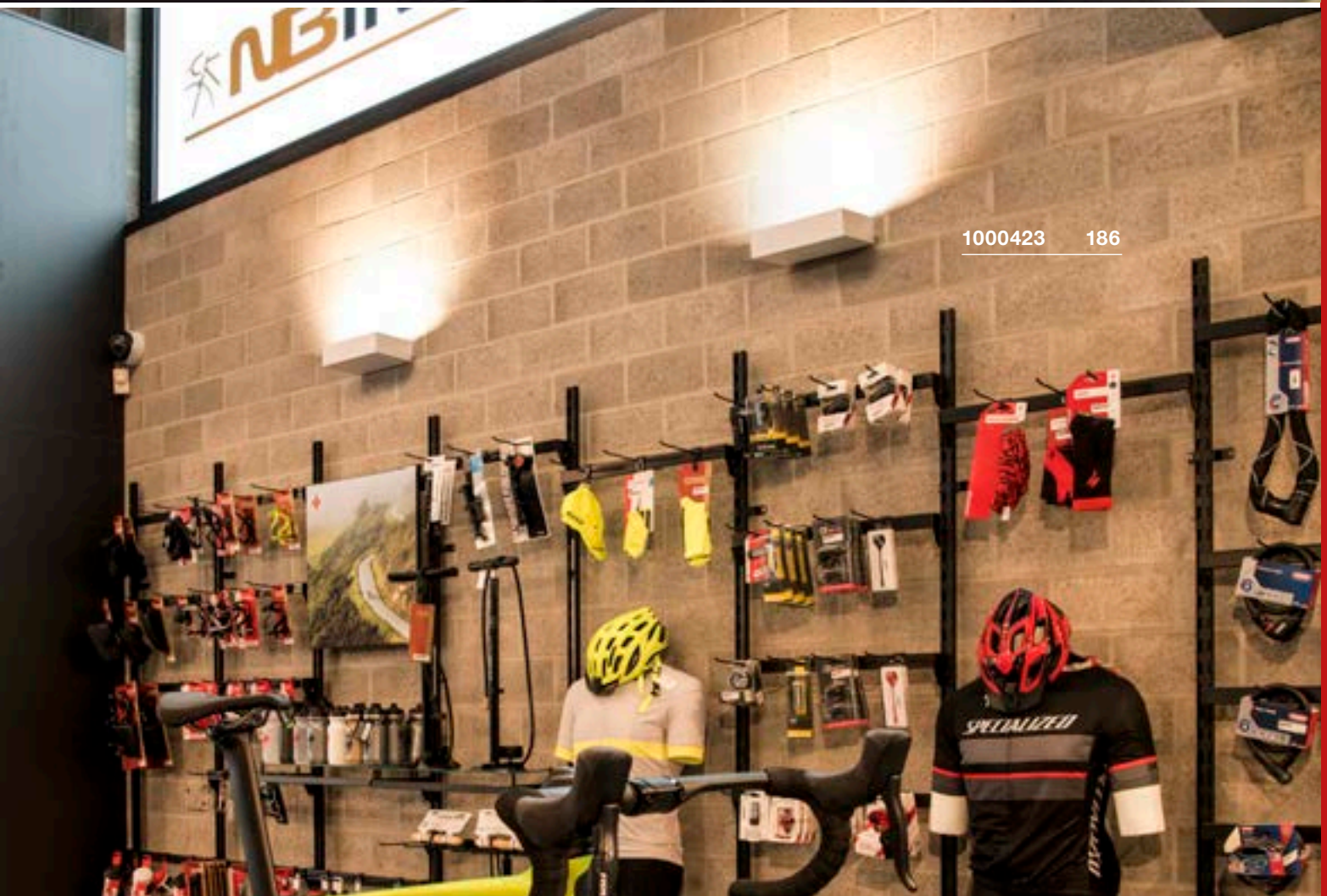

1000423 186

LENITO
WL

889

A-A++

Spektrum
A++-ELED
INSIDE

NEW

**Produktangaben**

220-240V ~50/60Hz | 160mA

Systemleistung: 24W

Material: Aluminium / Polycarbonat (PC)



0,55

30000

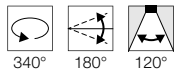

340°

180°

120°

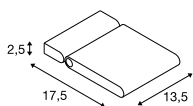
Maßzeichnung**Variante****Art. Nr.**

2450lm | 3000K | CRI>80

■ schwarz

1002920

2540lm | 3000K | CRI>80

□ weiß

1002921

1002920 188

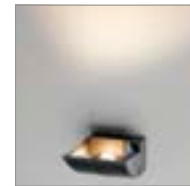
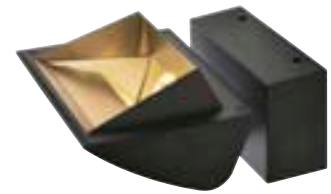

1001496 189

MERADO FLOOD
WLA-A++ Spektrum
A++-ELED
INSIDE

- Asymmetrische Lichtverteilung

Produktangaben

220-240V ~50/60Hz | 1000mA
Systemleistung: 40W
Material: Aluminium
Dimmbar: Triac C, Triac L

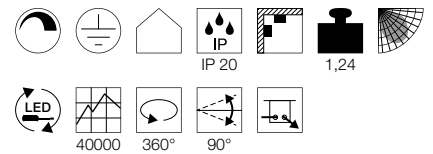

Maßzeichnung

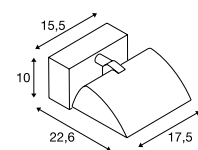

Variante	Art. Nr.
3000lm 3000K CRI>80	
■ schwarz	1001469
3000lm 3000K CRI>80	
□ weiß	1001468
3200lm 4000K CRI>80	
■ schwarz	1001473
3200lm 4000K CRI>80	
□ weiß	1001472

ALMINO
WL, UGR<19



A-A++ Spektrum
A++-E



- Geeignet für Industriebereiche, Lager- und Logistik
- Effiziente Grundbeleuchtung mit begrenzter Direktblendung, UGR< 19
- Besonders widerstandsfähiges Gehäuse

Produktangaben

220-240V ~50/60Hz | 300mA
Systemleistung: 45W
Material: Stahl / Polycarbonat (PC)

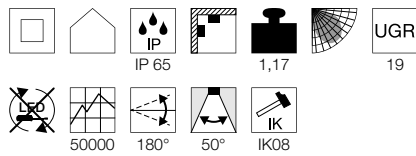

Maßzeichnung

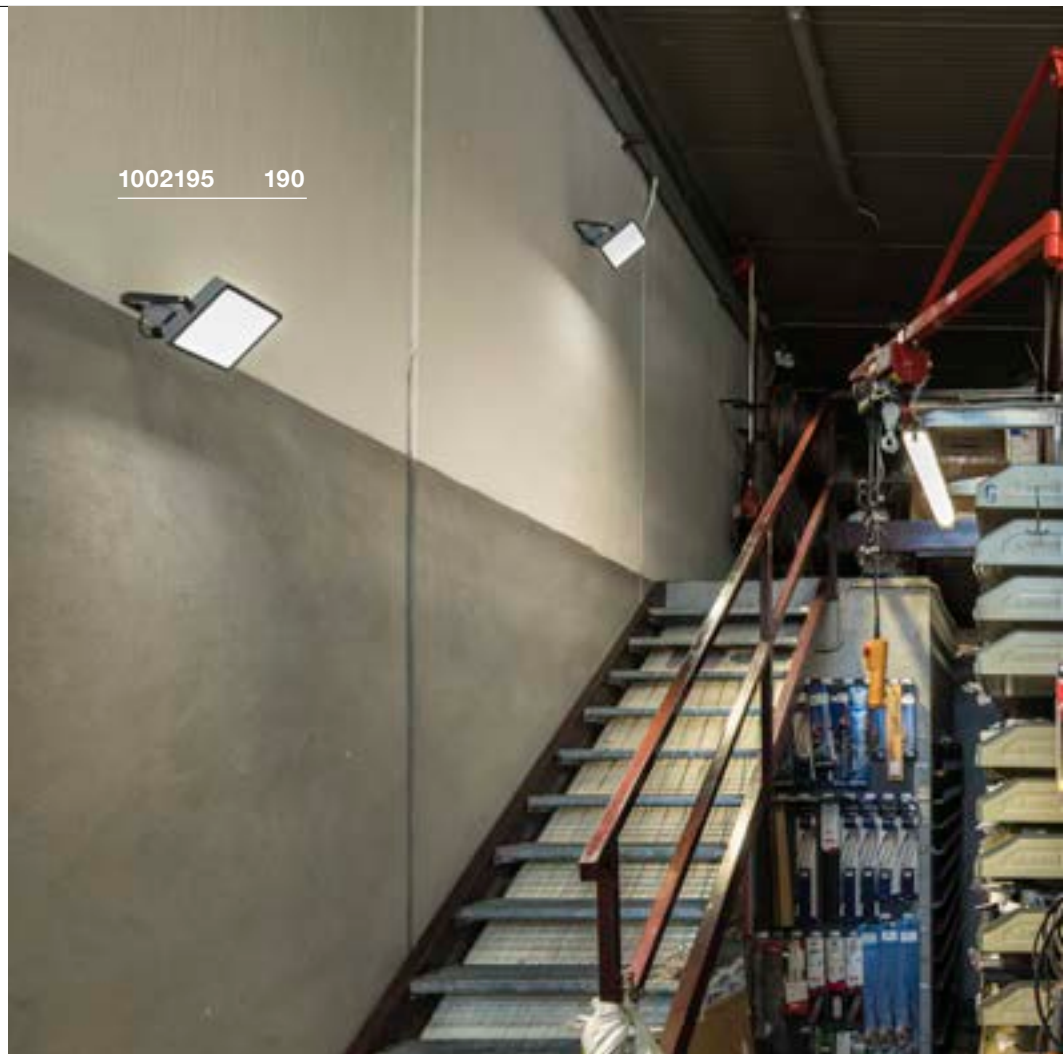
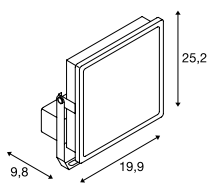

1002195 190

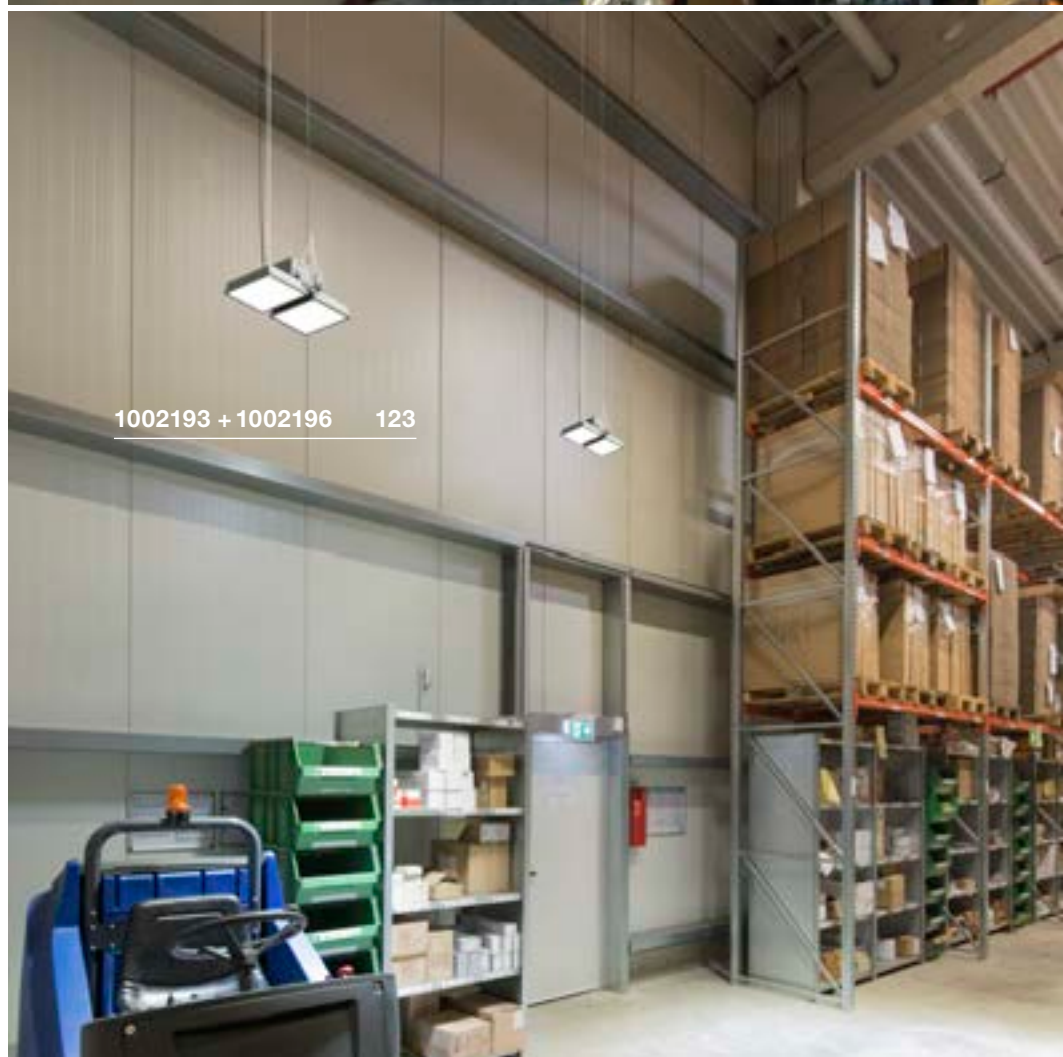

1002193 + 1002196 123

Variante	Art. Nr.
6200lm 4000K CRI>80 ■ grau / weiß	1002195

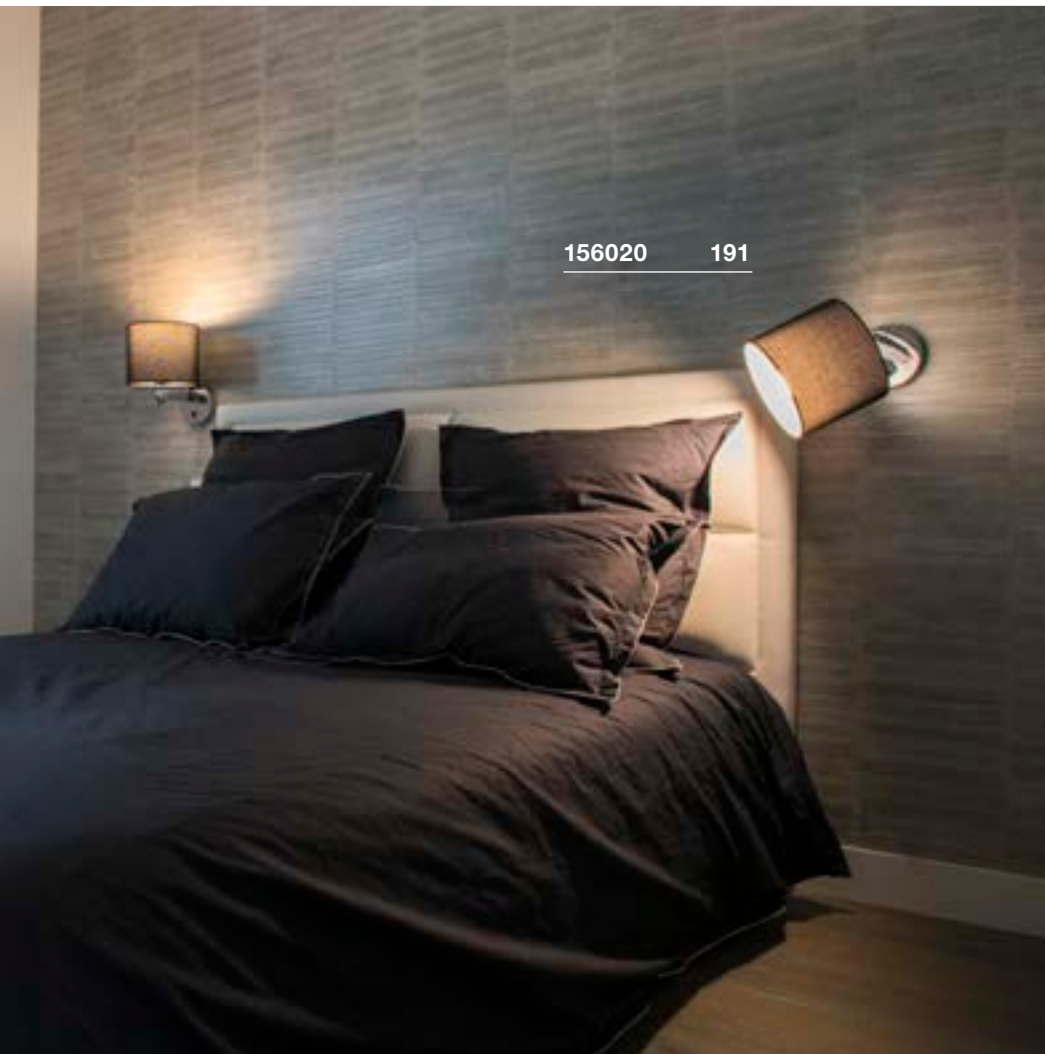

156020 191

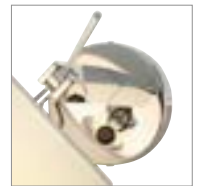
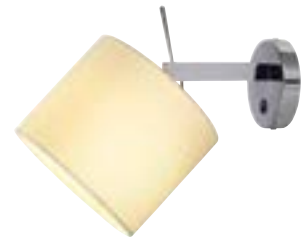
TENORA
WL, E27
 897
E-A++ Spektrum
A++-E

- Dreh- und schwenkbare Wandleuchte
- Schalter an der Rosette

Produktangaben

220-240V ~50/60Hz
Material: Aluminium / Textil



0,78

350°

Maßzeichnung

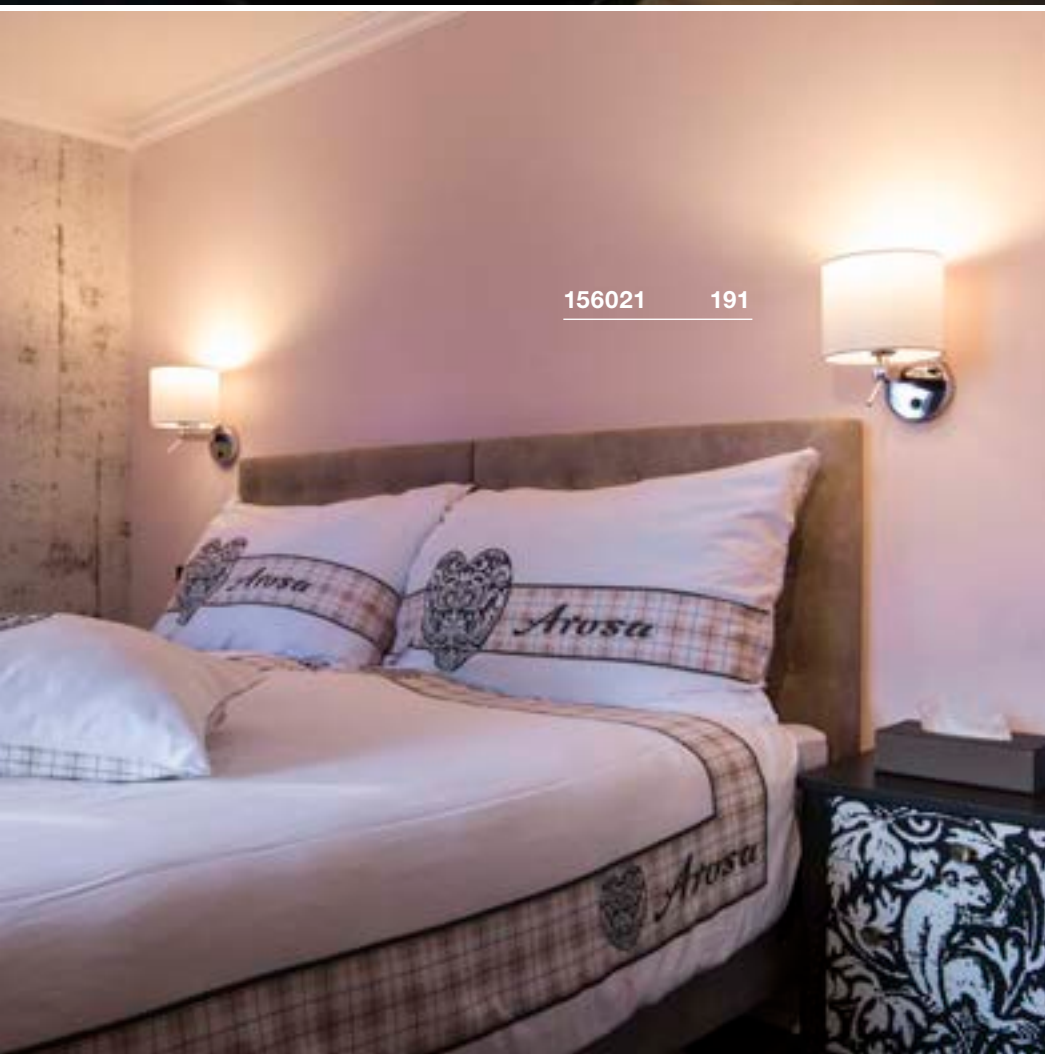
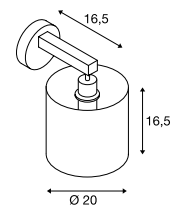

156021 191

Leuchtmittlempfehlung

LED E27 9,1W 240°
2700K 760lm EEK=A+
10kWh/1000h
Art. Nr. 560402



Leuchtmittelangaben

max. 60W

Variante	Art. Nr.
E27	
■ schwarz / chrom	156020
E27	
□ weiß	156021

FENDA
WL, Basis, E27



E-A++ Spektrum
A++-E



- Durch Auswahl der Leuchtschirme individuell gestaltbar

Produktangaben

230V ~50Hz
Material: Stahl

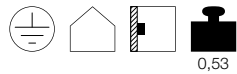

0,53

Maßzeichnung

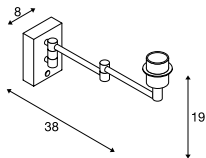

Leuchtmittlempfehlung

LED E27 9,1W 240°
2700K 760lm EEK=A+
10kWh/1000h
Art. Nr. 560402



LED E27 9W 240°
2700-6500K 806lm EEK=A+
9kWh/1000h
Art. Nr. 1001916



Leuchtmittelangaben

max. 40W
L: 12 cm max.

Variante	Art. Nr.
E27	
■ chrom	1001449
E27	
■ schwarz	1001450

FENDA
Ø 20cm, rund



- Durch Auswahl einer geeigneten Leuchtenbasis individuell gestaltbar

Produktangaben

Material: Textil / Stahl



0,19

Maßzeichnung

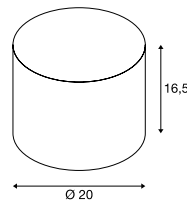

Hinweis

max. 60W

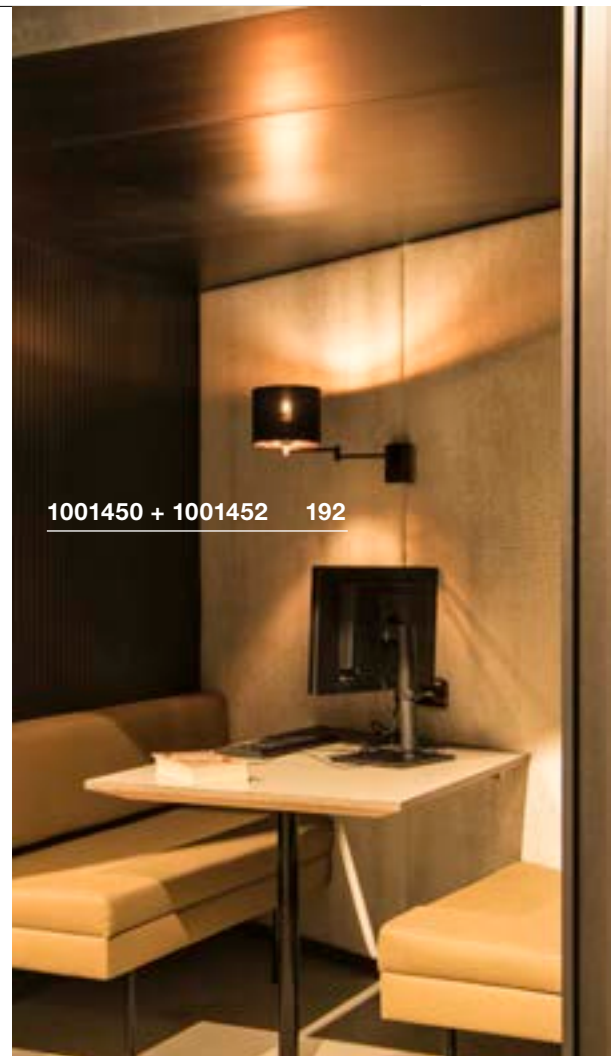

1001450 + 1001452 192



Variante	Art. Nr.
■ schwarz	1001451
■ schwarz / kupfer	1001452
■ weiß	1001453
■ beige	1001454



1001449 + 1001451 192

FENDA
WL, E27
 886
E-A++ Spektrum
A++-E

NEW



- Durch Auswahl der Leuchtschirme individuell gestaltbar
- Dreh- und schwenkbare Wandleuchte
- Schalter an der Rosette

Produktangaben

220-240V ~50/60Hz
Material: Stahl / Aluminium



0,56 350° 90°

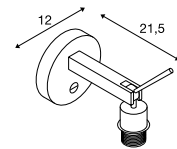

Maßzeichnung



1003034 + 156152 193 + 46

Leuchtmittelangaben

max. 40W

Variante	Art. Nr.
E27 ■ matt schwarz	1003034 
E27 □ matt weiß	1003035 

KENKUA SPOT
WL, E27

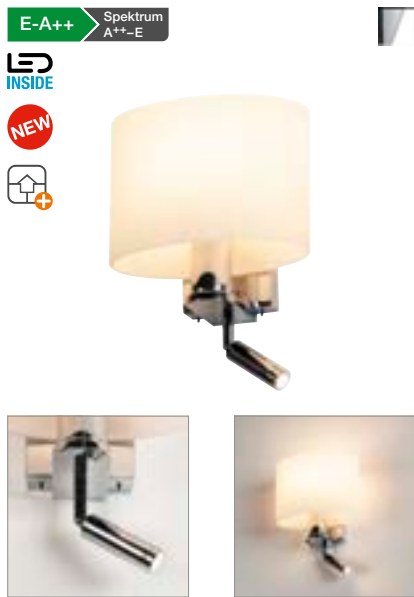

- Hochwertiges satiniertes Glas
- Verstellbares Leselicht
- Lichtquellen an der Rosette separat schaltbar

Produktangaben

100-277V ~50/60Hz | 700mA
Material: Stahl / Glas

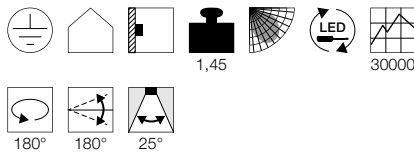

Maßzeichnung

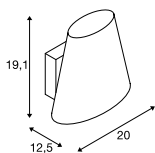

Leuchtmittelangaben

max. 40W

Variante	Art. Nr.
E27 Spot: 200lm 3000K CRI>80	
■ glänzend chrom / milchig	1002855

KENKUA
WL, E27

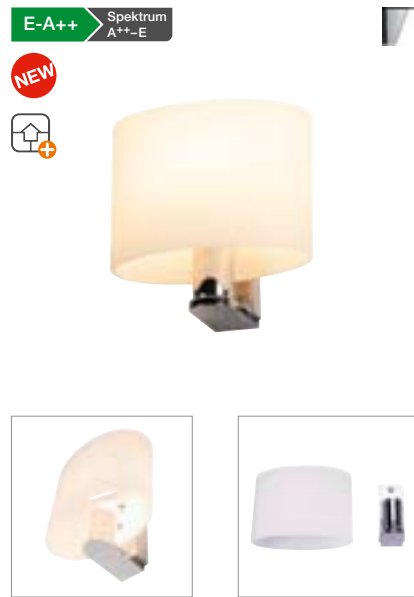

- Hochwertiges satiniertes Glas

Produktangaben

220-240V ~50/60Hz
Material: Stahl / Glas

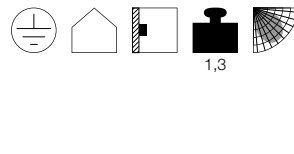

Maßzeichnung

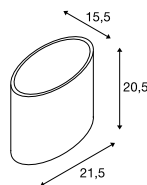

Leuchtmittelangaben

max. 40W

Variante	Art. Nr.
E27	
■ glänzend chrom / milchig	1002856

ACCANTO SPOT
SQUARE
WL, E27

882



Produktangaben

230V ~50Hz
Material: Stahl / Textil

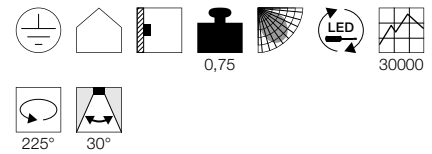

Maßzeichnung

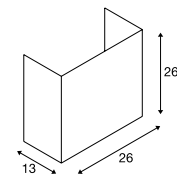

Leuchtmittelempfehlung

LED E27 9,1W 240°
2700K 760lm EEK=A+
10kWh/1000h
Art. Nr. **560402**



Leuchtmittelangaben

max. 24W
L: 17,3 cm max.

Variante	Art. Nr.
E27 Spot: 100lm 3000K CRI>80	
■ schwarz	155670
E27 Spot: 100lm 3000K CRI>80	
□ weiß	155673



155670 195

ACCANTO
WL, E27
 882
E-A++ Spektrum
A++-E

NEW

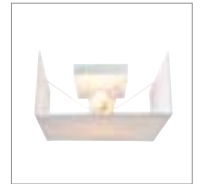

Produktangaben

220-240V ~50/60Hz
Material: Stahl / Textil

0,68

Maßzeichnung

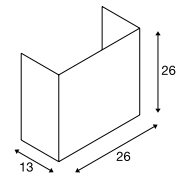



1002856 194

1002855 194

Leuchtmittelangaben

max. 40W

Variante	Art. Nr.
E27	
■ schwarz	1002942 
E27	
□ weiß	1002943 

COUPA FLEX WL

D-A++ Spektrum
A++-E

LED
INSIDE



- Lichtquellen separat schaltbar
- Schalter an der Rosette

Produktangaben

230V ~50Hz
Systemleistung: 4,8W
Material: Stahl / Glas

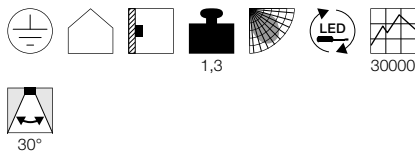

Maßzeichnung

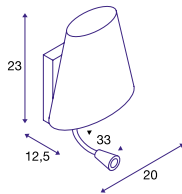

Leuchtmittlempfehlung

G9 2,7W
2600K 250lm EEK=A+
3kWh/1000h
Art. Nr. 560302



LED G9 2,5W
2700K 180lm EEK=A+
3kWh/1000h
Art. Nr. 1002131



Leuchtmittelangaben

max. 40W QT14
L: 9 cm max.

Variante	Art. Nr.
G9 QT14 Spot: 125lm 3000K CRI>80 ■ chrom / weiß	149452

149452 196

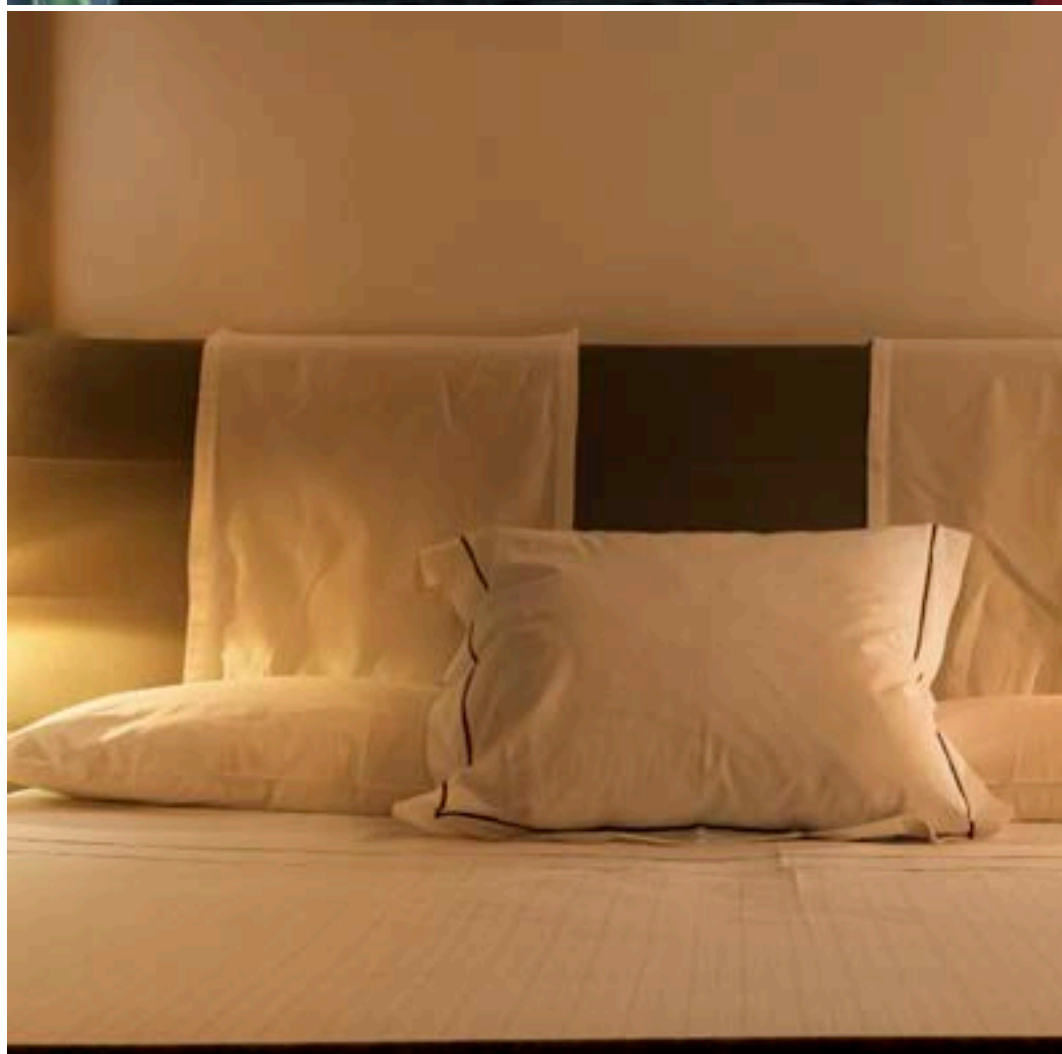

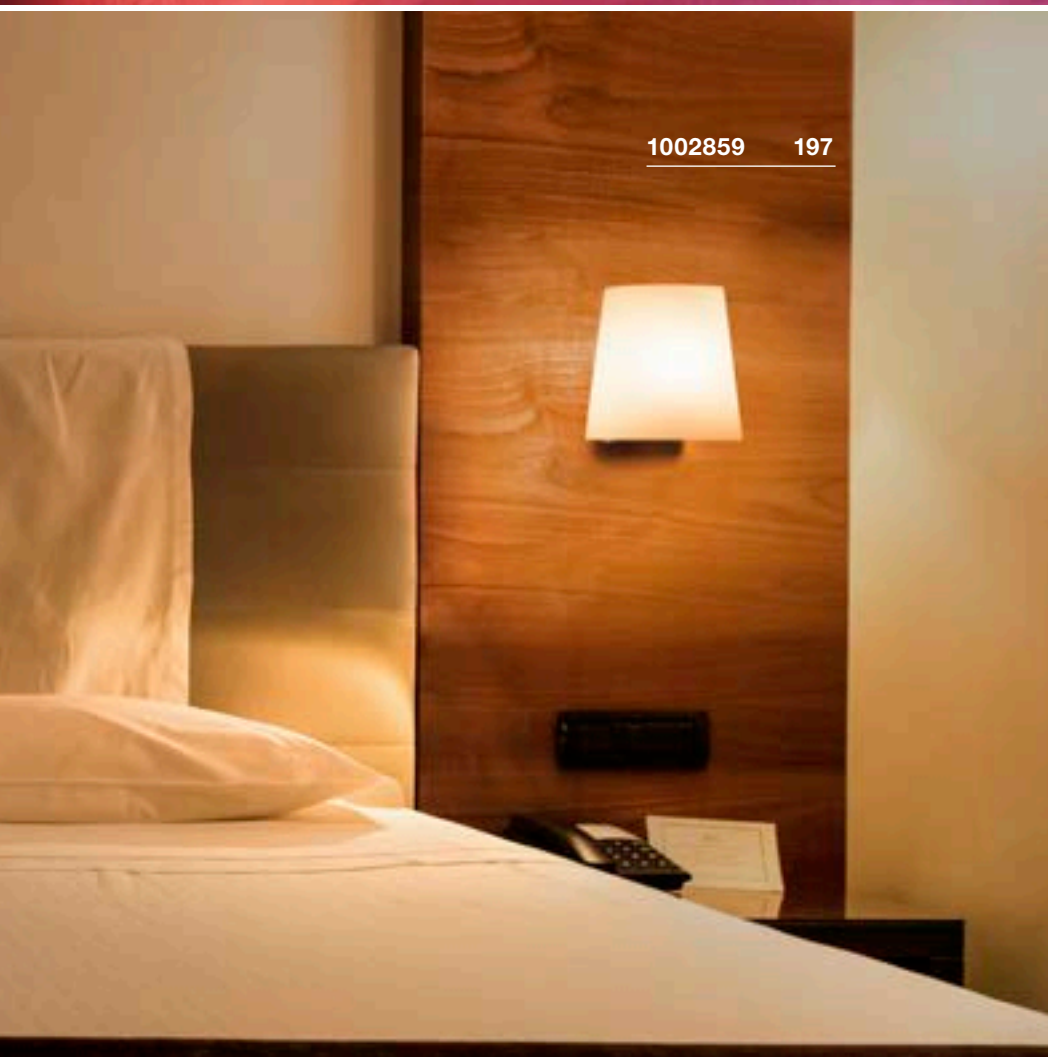

1002859 197

COUPA
WL, QT14D-A+ Spektrum
A++-E

NEW

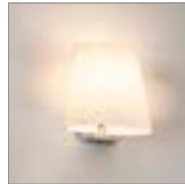

- Hochwertiges, satiniertes Glas

Produktangaben

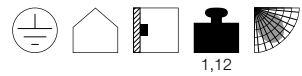
220-240V ~50/60Hz
Material: Stahl / Glas

Maßzeichnung

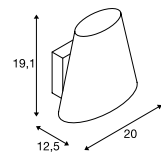

Leuchtmittelempfehlung

G9 2,7W
2600K 250lm EEK=A+
3kWh/1000h
Art. Nr. 560302LED G9 2,5W
2700K 180lm EEK=A+
3kWh/1000h
Art. Nr. 1002131

Leuchtmittelangaben

max. 42W QT14
L: 9 cm max.

Variante	Art. Nr.
G9 QT14 ■ chrom / weiß	1002859

MANA
WL, Basis



891

A-A++ Spektrum
A++-E



- Premium LED mit CRI>90
- Mit verstellbarem Leselicht, Lichtquellen separat schaltbar

Produktangaben

100-240V ~50/60Hz | 320mA/500mA
Systemleistung: 11W
Material: Aluminium / Stahl



0,7

30000

30°

Maßzeichnung

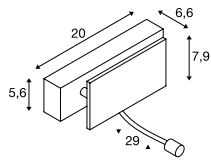

1000615 + 1000629 198 + 199

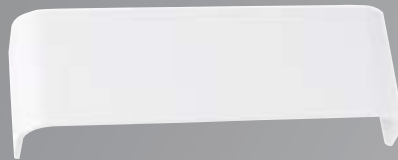
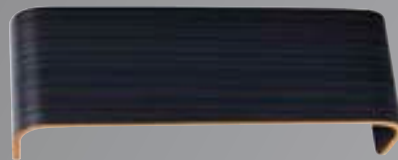

Variante	Art. Nr.
----------	----------

Flood: 490lm | 3000K | CRI>90
Spot: 80lm | 3000K | CRI>90

weiß / chrom

1000615

MANA Schirm



MANA Schirm



MANA Schirm



- Individuell gestaltbar mit Farben, Stickern & mehr

Produktangaben

Material: Gips / Stahl



Maßzeichnung

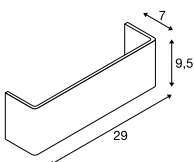

Hinweis

passend nur zu 1000614/1000615



Maßzeichnung

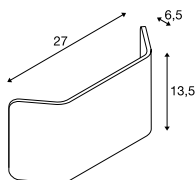

Hinweis

passend nur zu 1000614/1000615



0,93

Maßzeichnung

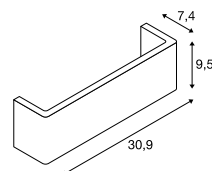

Hinweis

passend nur zu 1000614/1000615

Variante	Art. Nr.
Holz 0,16 kg	
■ grau / braun	1000621
Aluminium 0,39 kg	
□ weiß	1000623
Aluminium 0,39 kg	
■ aluminium	1000624

Variante	Art. Nr.
Holz 0,2 kg	
■ grau / braun	1000626
Aluminium 0,47 kg	
□ weiß	1000628
Aluminium 0,47 kg	
■ aluminium	1000629

Variante	Art. Nr.
□ weiß	1000825

NAPIA
WL

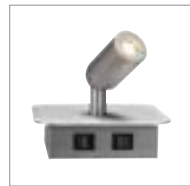

- Direkte und indirekte Beleuchtung
- Lichtquellen separat schaltbar

Produktangaben

220-240V ~50/60Hz | 350mA
Systemleistung: 3,8W
Material: Aluminium

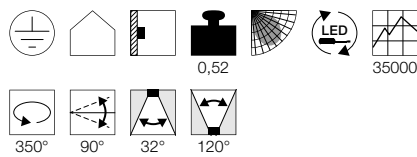

Maßzeichnung

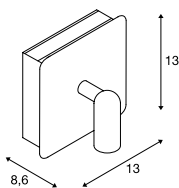

NAPIA TWIN
WL



- Direkte und indirekte Beleuchtung
- Lichtquellen separat schaltbar

Produktangaben

220-240V ~50/60Hz
Systemleistung: 21W
Material: Aluminium

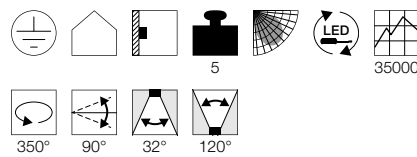

Maßzeichnung

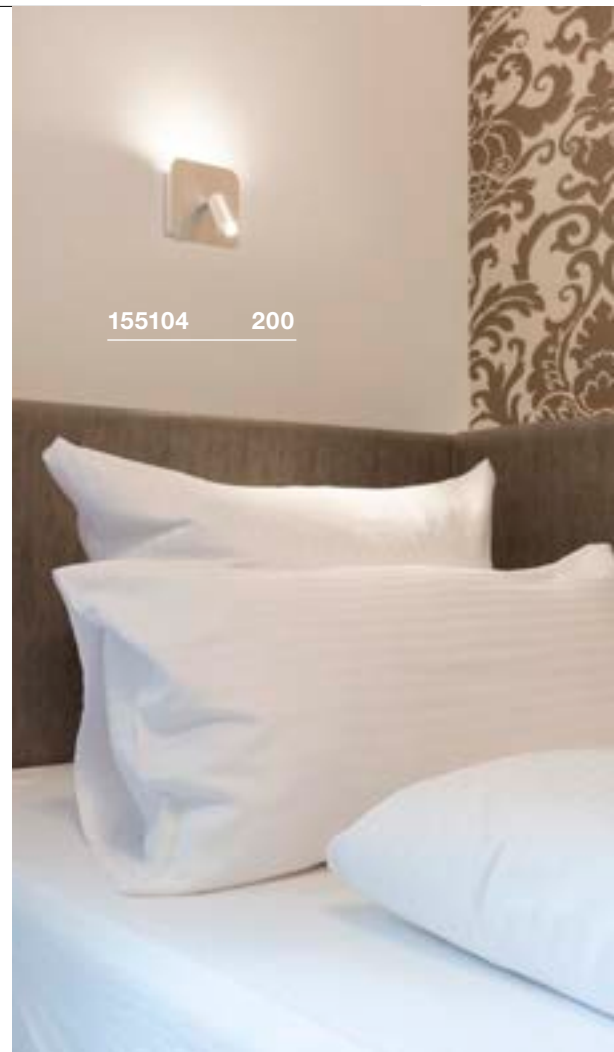
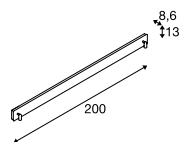

155104 200



155100 200

Variante	Art. Nr.
Direkt: 95lm 3000K CRI>80 Indirekt: 62lm 3000K CRI>80 ■ schwarz	155100
Direkt: 95lm 3000K CRI>80 Indirekt: 62lm 3000K CRI>80 □ weiß	155101
Direkt: 95lm 3000K CRI>80 Indirekt: 62lm 3000K CRI>80 ■ matt aluminium	155104

Variante	Art. Nr.
Direkt: 95lm 3000K CRI>80 Indirekt: 470lm 3000K CRI>80 □ weiß	1001822
Direkt: 95lm 3000K CRI>80 Indirekt: 470lm 3000K CRI>80 ■ matt aluminium	155114



155100 200

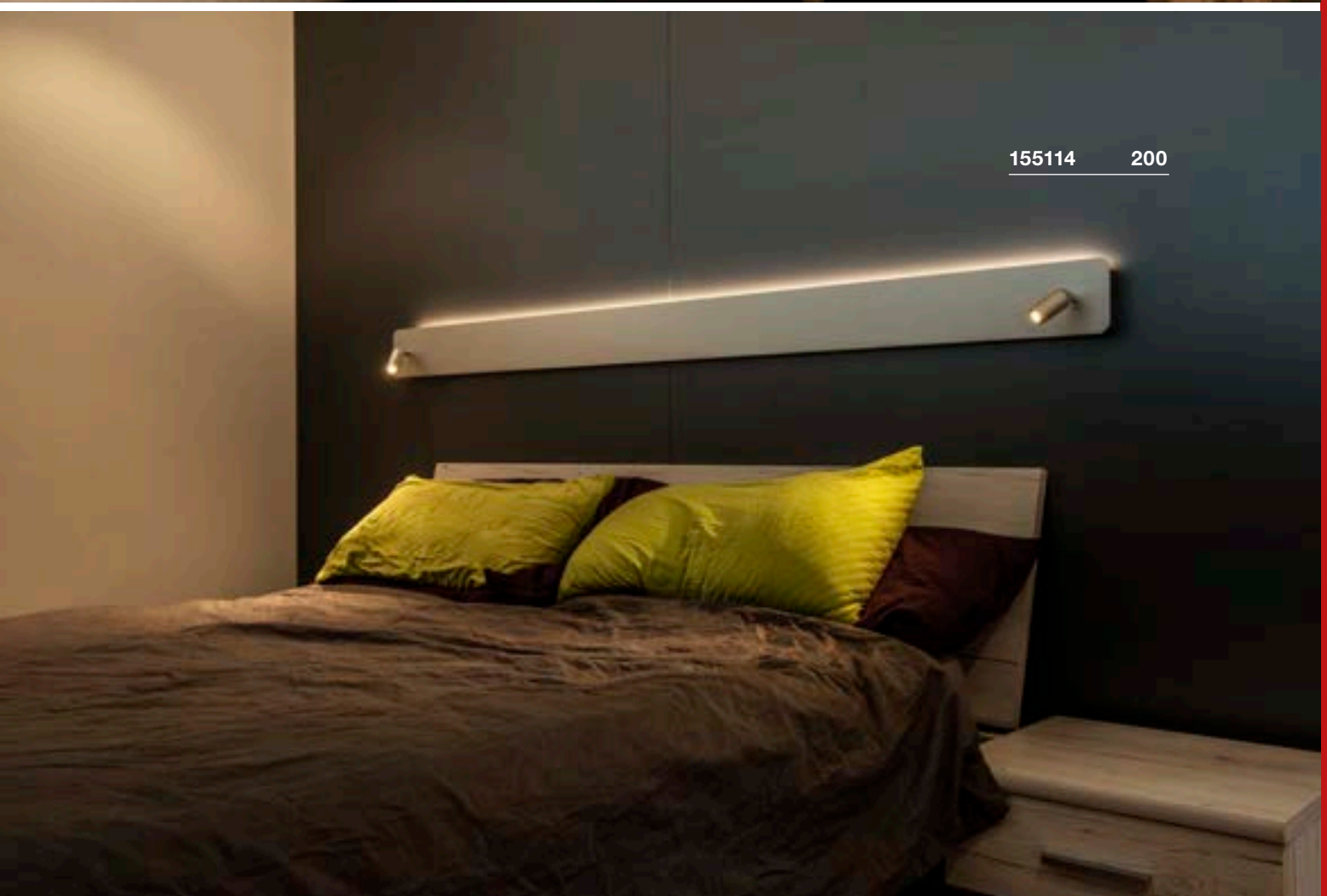

155114 200

1000326 202

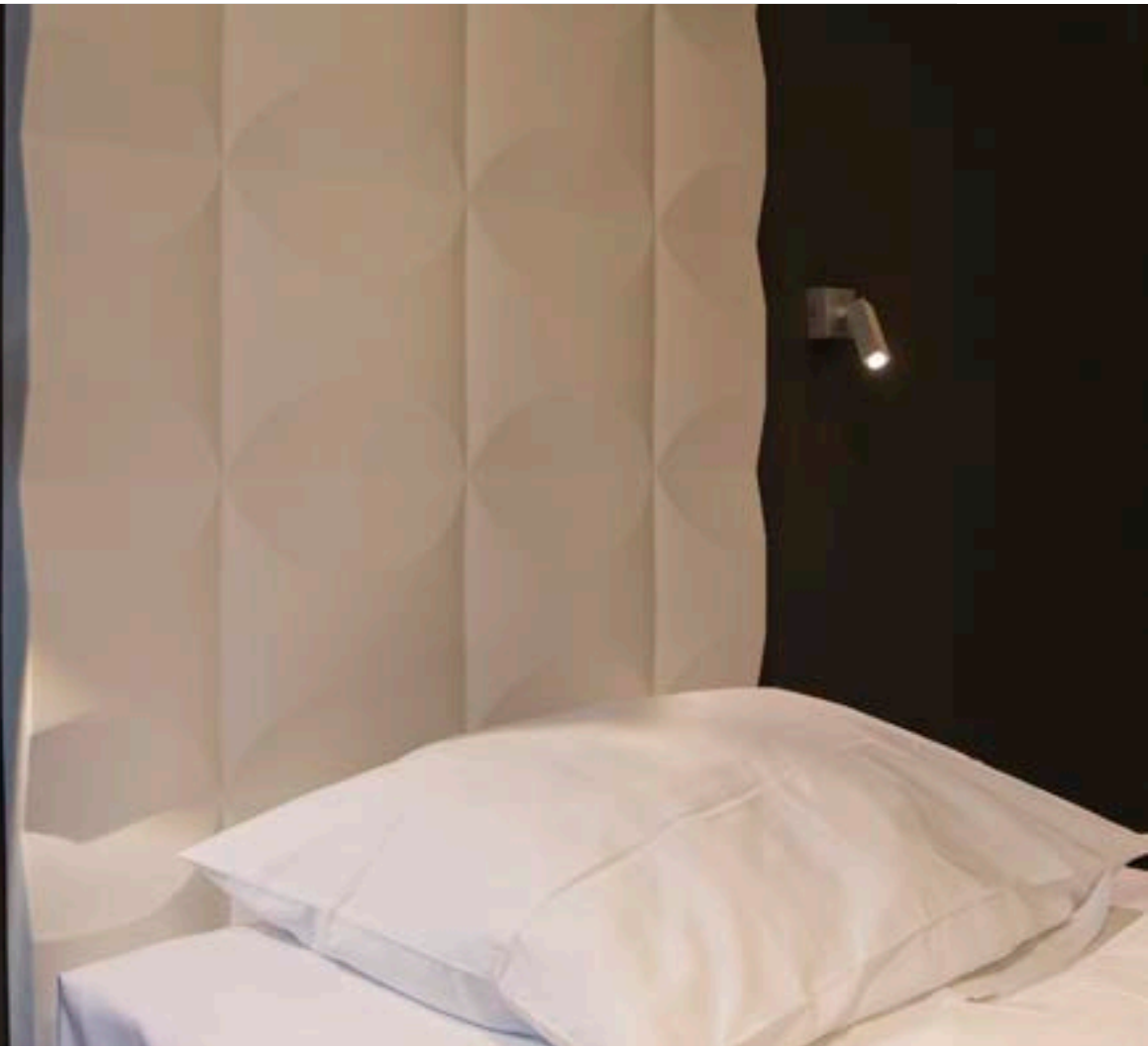

148540 202



STIX
WL

A-A++ Spektrum A++-E



- Dreh- und schwenkbarer Leuchtenkopf
- Schalter an der Rosette

Produktangaben

100-240V ~50/60Hz | 700mA
Systemleistung: 4,5W
Material: Aluminium

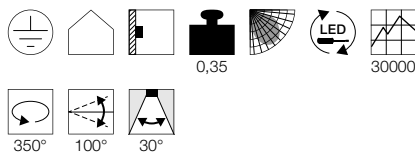

Maßzeichnung

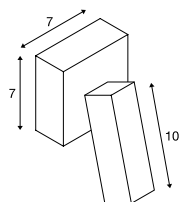

PHELIA
WL, QPAR51



E-A++ Spektrum A++-E



- Schalter am Leuchtenkopf
- Leuchtschirme innen weiß lackiert

Produktangaben

230V ~50/60Hz
Material: Aluminium / Stahl

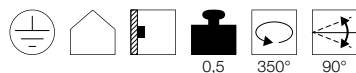

Maßzeichnung

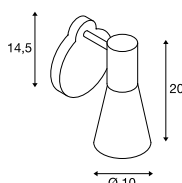

Leuchtmittlempfehlung

LED GU10 5,5W 38°
2700K 400lm EEK=A+
6kWh/1000h
Art. Nr. 1001030



LED GU10 7,2W 36°
2700K 570lm EEK=A+
8kWh/1000h
Art. Nr. 560542



Leuchtmittelangaben

max. 35W QPAR51
Ø: 5 cm max. L: 10,5 cm max.

Variante	Art. Nr.
185lm 3000K CRI80	
■ schwarz	1000324
185lm 3000K CRI80	
□ weiß	1000325
185lm 3000K CRI80	
■ grau	1000326

PHELIA
WL, QPAR51



E-A++ Spektrum A++-E



- Leuchtschirme innen weiß lackiert

Produktangaben

230V ~50/60Hz
Material: Aluminium / Stahl

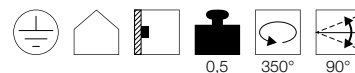

Maßzeichnung

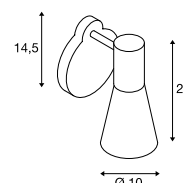

Leuchtmittlempfehlung

LED GU10 5,5W 38°
2700K 400lm EEK=A+
6kWh/1000h
Art. Nr. 1001030



LED GU10 7,2W 36°
2700K 570lm EEK=A+
8kWh/1000h
Art. Nr. 560542



Leuchtmittelangaben

max. 35W QPAR51
Ø: 5 cm max. L: 10,5 cm max.

Variante	Art. Nr.
GU10 QPAR51	
□ weiß	1002122

ENOLA B
WL, QPAR51



E-A++ Spektrum A++-E



• Schalter an der Rosette

Produktangaben

230V ~50Hz
Material: Aluminium / Stahl

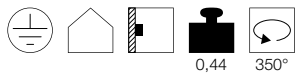

Maßzeichnung

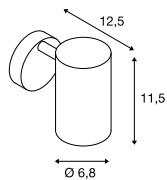

Zubehörempfehlung

■ Zierring
Art. Nr. 151840



Leuchtmittlempfehlung

LED GU10 5,5W 38°
2700K 400lm EEK=A+
6kWh/1000h
Art. Nr. 1001030



LED GU10 5,1W 48°
2700-6500K 350lm EEK=A+
6kWh/1000h
Art. Nr. 1001918



Leuchtmittelangaben

max. 50W QPAR51
L: 6 cm max.

Variante	Art. Nr.
GU10 QPAR51	
■ schwarz	1000729
GU10 QPAR51	
□ weiß	1000730
GU10 QPAR51	
■ gold	1000731
GU10 QPAR51	
■ grau	1000732



1000731 204





152341 205



1002140 205

KARPO 30
CW, single



A-A++ Spektrum A++-E



- Premium LED mit CRI>90
- Schalter an der Rosette

Produktangaben

100-240V ~50/60Hz | 500mA
Systemleistung: 6W
Material: Aluminium / Stahl

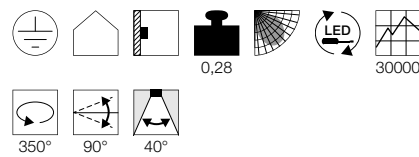

Maßzeichnung

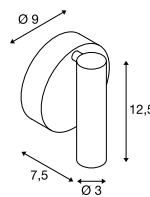

KARPO
WL



A-A++ Spektrum A++-E



- Premium LED mit CRI>90
- 3-Step-Dim
- Zwei USB Anschlüsse (1,5A max belastbar)

Produktangaben

220-240V ~50/60Hz | 500mA
Systemleistung: 6,6W
Dimmbar: Switch

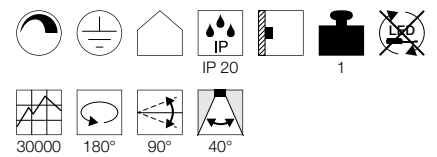

Maßzeichnung

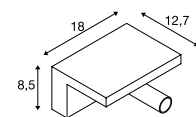

Variante	Art. Nr.
330lm 3000K CRI>90	
■ schwarz	152340
380lm 3000K CRI>90	
□ weiß	152341
360lm 3000K CRI>90	
■ gold	1002173

Variante	Art. Nr.
390lm 3000K CRI>90	
□ weiß	1002140

146700 206

PIPOFLEX
WLA-A++ Spektrum
A++-ELED
INSIDE

- Schalter an der Rosette

Produktangaben

220-240V ~50/60Hz | 266mA
Systemleistung: 4,6W
Material: Aluminium



Maßzeichnung

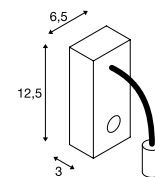

Variante	Art. Nr.
200lm 3000K CRI>80	
■ schwarz	146700
200lm 3000K CRI>80	
□ weiß	146701
200lm 3000K CRI>80	
■ grau	146704



1002607 207

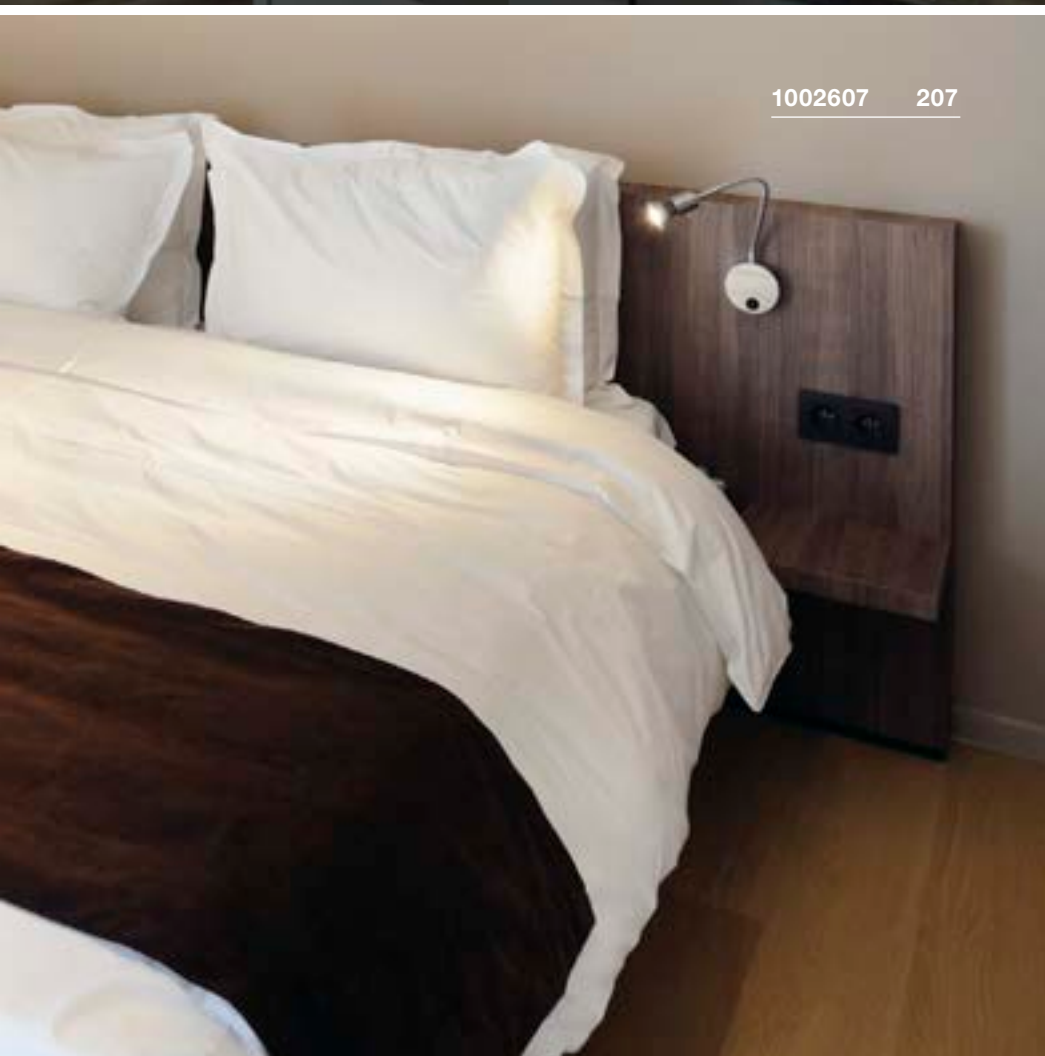

1002607 207

DIO FLEX PLATE WL QPAR51

E-A++ Spektrum
A++-E



NEW
COLOR



- Schalter an der Rosette

Produktangaben

230V ~50Hz
Material: Aluminium

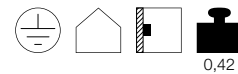

0,42

Maßzeichnung

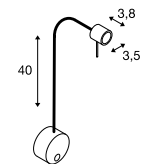

Zubehörempfehlung

■ Leuchtmittel Dekoring Ø 5,7cm
Art. Nr. 151040



Leuchtmittlempfehlung

LED GU10 7,2W 36°
2700K 520lm EEK=A+
8kWh/1000h
Art. Nr. 1001560



LED GU10 7,2W 36°
3000K 520lm EEK=A+
8kWh/1000h
Art. Nr. 1001562



Leuchtmittelangaben

max. 50W QPAR51

Variante	Art. Nr.
GU10 QPAR51 □ weiß	1002607
GU10 QPAR51 ■ schwarz	1002608
GU10 QPAR51 ■ chrom	146692

DIO FLEX PLATE
WLLED
INSIDE

- Schalter an der Rosette

Produktangaben

100-240V ~50/60Hz | 320mA
Systemleistung: 1,9W
Material: Aluminium

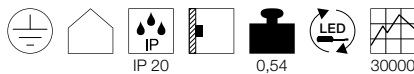

Maßzeichnung

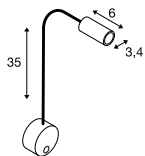

Variante	Art. Nr.
82lm 2700K CRI>80 □ weiß	1002117
82lm 2700K CRI>80 ■ chrom	1002116
82lm 2700K CRI>80 ■ schwarz	1002430
82lm 3000K CRI>80 □ weiß	1002118
82lm 3000K CRI>80 ■ chrom	146682
82lm 3000K CRI>80 ■ schwarz	1002431
82lm 4000K CRI>80 □ weiß	1002119
82lm 4000K CRI>80 ■ chrom	146680
82lm 4000K CRI>80 ■ schwarz	1002432

1002117 208



1002431 208





146512 209

IVED GOOSE WL, Rosette

A-A++ Spektrum
A++-E



Produktangaben

100-240V ~50/60Hz | 350mA
Systemleistung: 2,2W
Material: Aluminium



Maßzeichnung

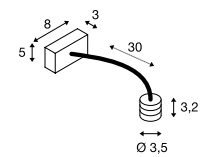

Variante	Art. Nr.
----------	----------

80lm 3000K CRI>80	
-----------------------	--

■ grau	
--------	--

146512

MAGANDA
WL



A-A++ Spektrum
A++-E

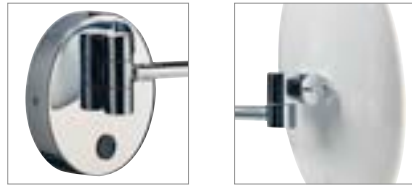

- Beleuchteter äußerer Rand
- Schalter an der Rosette
- 3 fach optische Vergrößerung

Produktangaben

100-240V ~50/60Hz | 12V DC
Systemleistung: 4,2W
Material: Stahl / Glas

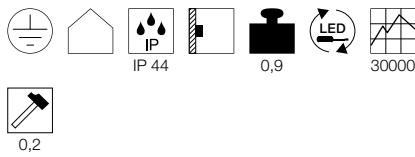

Maßzeichnung

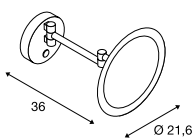

VISSARDO
WL

A-A++ Spektrum
A++-E



- Schalter an der Rosette
- 3 fach optische Vergrößerung

Produktangaben

100-240V ~50/60Hz
Systemleistung: 5,8W
Material: Stahl / Glas

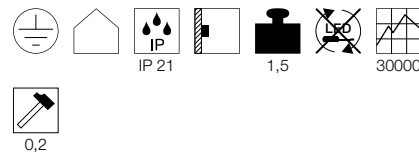

Maßzeichnung

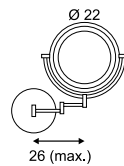

1001503 210



149772 211



Variante	Art. Nr.
70lm 3000K CRI>80 ■ chrom / transparent	1001503

Variante	Art. Nr.
130lm 3000K CRI>80 ■ chrom	149782



TRUKKO
WL

A-A++ Spektrum
A++-E



TRUKKO 60/90
WL

A-A++ Spektrum
A++-E



Produktangaben

100-240V ~50/60Hz | 700mA
Systemleistung: 9W

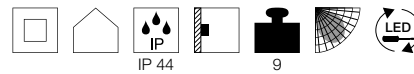

Produktangaben

100-240V ~50/60Hz | 500mA
Material: Stahl / Kunststoff

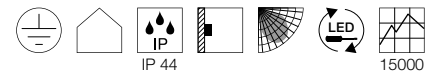

Maßzeichnung



Maßzeichnung

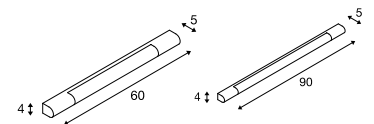

Variante	Art. Nr.
250lm 3000K CRI>80 □ transparent	149752

Variante	Art. Nr.
450lm 8,8W 3000K CRI>80 H: 60 cm 0,75 kg	149762
□ chrom/weiß	
710lm 11,4W 3000K CRI>80 H: 90 cm 0,8 kg	149772
□ chrom/weiß	

MARYLIN
WL

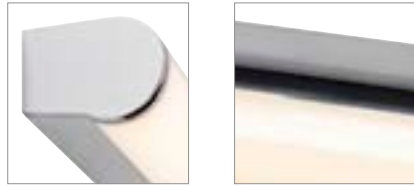

Produktangaben

220-240V ~50/60Hz | 600mA
Material: Aluminium / Polycarbonat (PC)

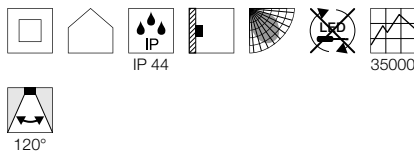

Maßzeichnung

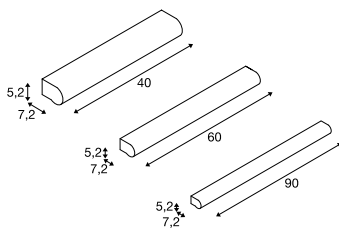

Variante	Art. Nr.
800lm 10W 3000K CRI>80 L: 40 cm 0,85 kg ■ chrom / weiß	1002190
1200lm 15W 3000K CRI>80 L: 60 cm 1,12 kg ■ chrom / weiß	1002191
1700lm 21W 3000K CRI>80 L: 90 cm 1,64 kg ■ chrom / weiß	1002192

DEVIN
WL, Double



• Elegante Aluminium-Glas Kombination

Produktangaben

220-240V ~50/60Hz
Systemleistung: 16W
Material: Stahl / Glas
Dimmbar: Triac C, Triac L

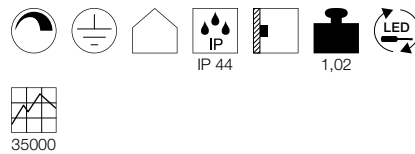

Maßzeichnung

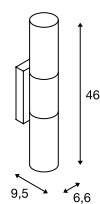

Variante	Art. Nr.
890lm 3000K CRI>80 ■ chrom / weiß	151553

1002191 212



151553 212



WL 106
E14

E-A++ Spektrum
A++-E



Produktangaben

220-240V ~50/60Hz
Material: Aluminium / Glas



Maßzeichnung

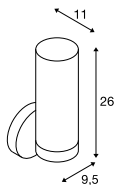

Leuchtmittelpfhlung

LED E14 6,5W 280°
3000K 480lm EEK=A+
7kWh/1000h
Art. Nr. 560372



LED E14 4W
2700K 250lm EEK=A+
4kWh/1000h
Art. Nr. 560222



Leuchtmittelangaben

max. 40W
Ø: 3,6 cm max. L: 11 cm max.

Variante	Art. Nr.
■ chrom	1002228

WL 106
E14

E-A++ Spektrum
A++-E



Produktangaben

220-240V ~50/60Hz
Material: Aluminium / Glas



Maßzeichnung

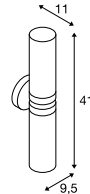

Leuchtmittelpfhlung

E14 4W
2700K 250lm EEK=A+
4kWh/1000h
Art. Nr. 560222



Leuchtmittelangaben

2x max. 40W
Ø: 3,6 cm max. L: 11 cm max.

Variante	Art. Nr.
■ chrom	1002229



1002229 213



151282 214

MIBO UP/DOWN
WL, QT14D-A+ Spektrum
A++-E

Produktangaben

220-240V ~50/60Hz
Material: Aluminium / Glas

IP 21

0,4

Maßzeichnung

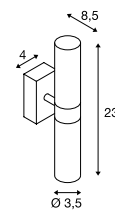

Leuchtmittelempfehlung

G9 2,5W
2700K 180lm EEK=A+
3kWh/1000h
Art. Nr. 560302LED G9 3,5W
2800K 300lm EEK=A+
4kWh/1000h
Art. Nr. 1002131

Leuchtmittelangaben

2x max. 25W QT14

Variante	Art. Nr.
G9 QT14	
■ chrom	151282

DORISA 30

A-A++ Spektrum A++-E



- Durch abmontieren der Halterung zur Spiegelleuchte umfunktionierbar

Produktangaben

220-240V ~50/60Hz | 340mA
Systemleistung: 5,2W
Material: Aluminium / Kunststoff



Maßzeichnung

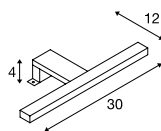

Hinweis

Klemmbereich: 0-6 mm

Variante	Art. Nr.
280lm 4000K CRI>80 ■ chrom	1000777
280lm 4000K CRI>80 ■ matt grau	1000778

DORISA 50

A-A++ Spektrum A++-E



- Durch abmontieren der Halterung zur Spiegelleuchte umfunktionierbar

Produktangaben

220-240V ~50/60Hz | 340mA
Systemleistung: 6,6W
Material: Aluminium / Kunststoff



Maßzeichnung

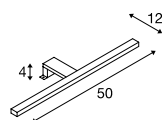

Hinweis

Klemmbereich: 0-6 mm

Variante	Art. Nr.
370lm 4000K CRI>80 ■ chrom	1000780
370lm 4000K CRI>80 ■ matt grau	1000781



DORISA 20
square

A-A++ Spektrum
A++-E

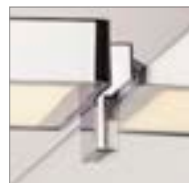

• Durch abmontieren der Halterung zur Spiegelleuchte umfunktionierbar

Produktangaben

220-240V ~50/60Hz | 340mA
Systemleistung: 5,5W
Material: Aluminium / Kunststoff

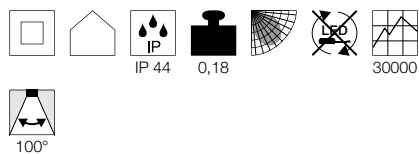

Maßzeichnung

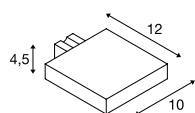

Hinweis

Klemmbereich: 0-6 mm

DORISA 40
rectangular

A-A++ Spektrum
A++-E



• Durch abmontieren der Halterung zur Spiegelleuchte umfunktionierbar

Produktangaben

220-240V ~50/60Hz | 340mA
Systemleistung: 6,6W
Material: Aluminium / Kunststoff

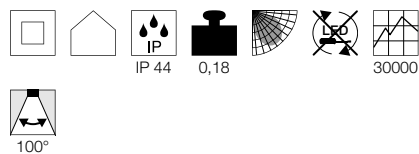

Maßzeichnung

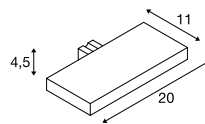

Hinweis

Klemmbereich: 0-6 mm

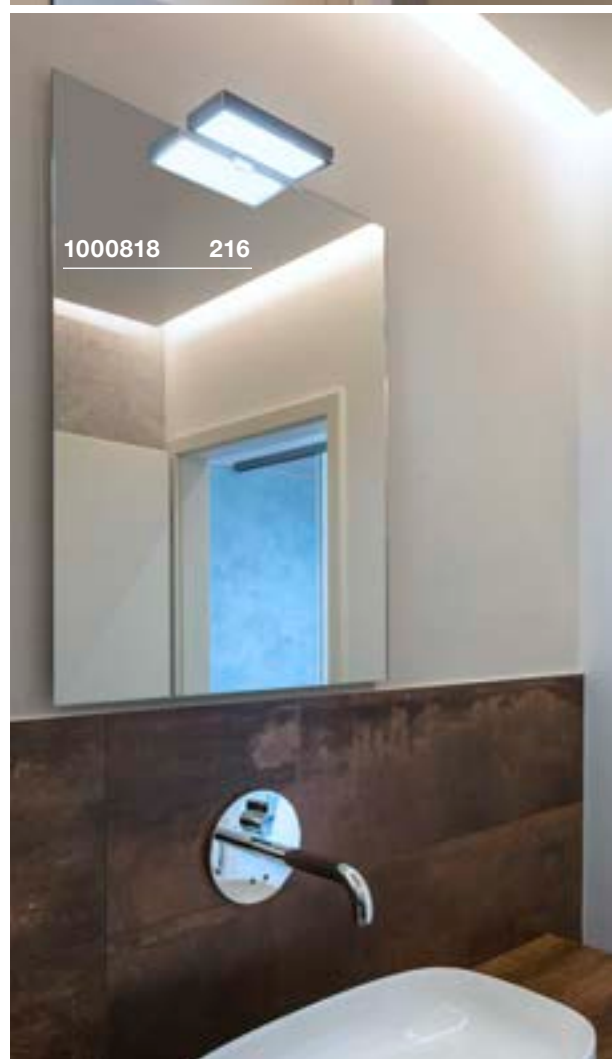

Variante	Art. Nr.
230lm 4000K CRI>80 ■ chrom	1000816

Variante	Art. Nr.
310lm 4000K CRI>80 ■ chrom	1000818



1000816 216



BADLEUCHTEN HIGHLIGHTS. UNSER PERFEKTES LICHT IM BAD.



1000669 221



GLENOS® 60 | 219



L-LINE 60 | 220



L-LINE 120 | 220



Q-LINE® | 221

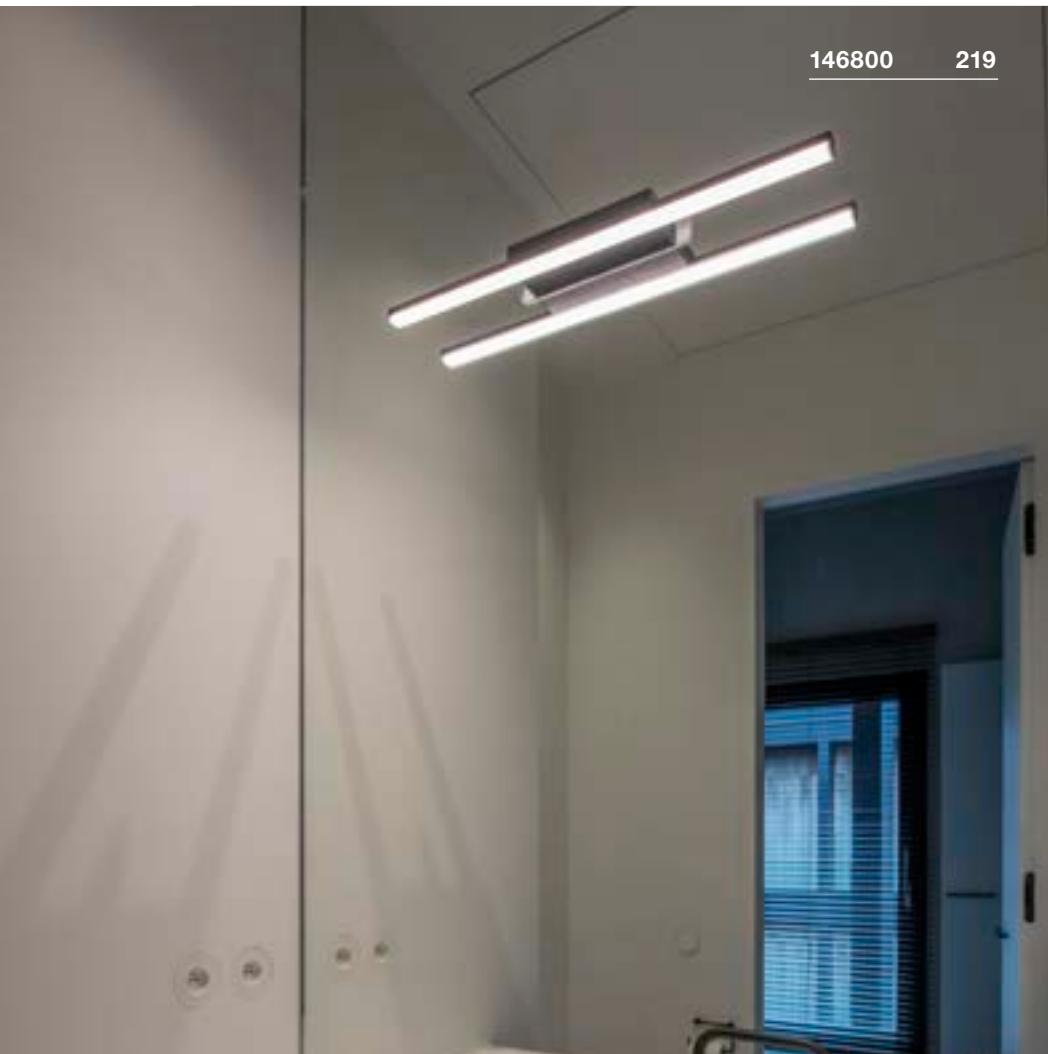

146800 219

GLENOS® 60

A-A++ Spektrum A++-E

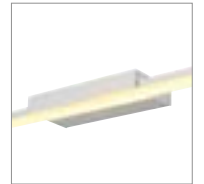

Produktangaben

100-240V ~50/60Hz | 24V DC
 Systemleistung: 17W
 Material: Aluminium / Acryl

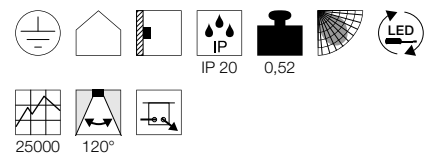

Maßzeichnung

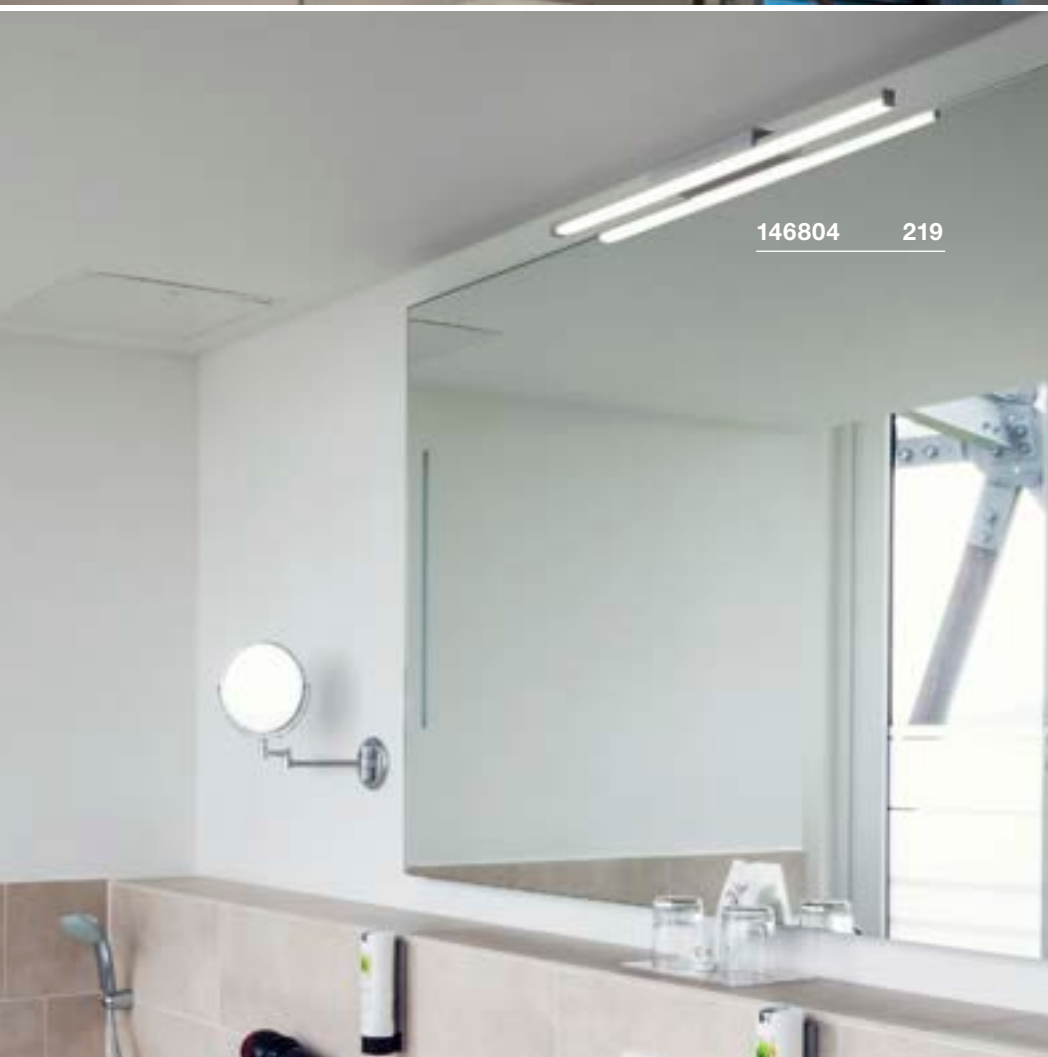
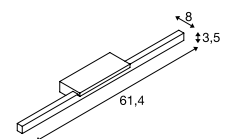

146804 219

Variante	Art. Nr.
1000lm 3000K CRI>80	
■ schwarz	146800
1000lm 3000K CRI>80	
□ weiß	146801
1000lm 3000K CRI>80	
■ grau	146804

L-LINE 60



Produktangaben

220-240V ~50/60Hz | 350mA
 Systemleistung: 10W
 Material: Aluminium / Polycarbonat (PC)

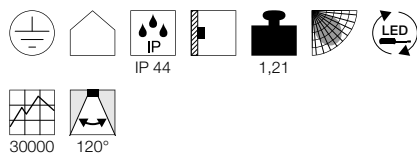

Maßzeichnung

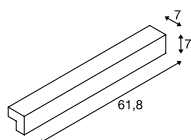

L-LINE 120



Produktangaben

220-240V ~50/60Hz | 350mA
 Systemleistung: 18,5W
 Material: Aluminium / Polycarbonat (PC)

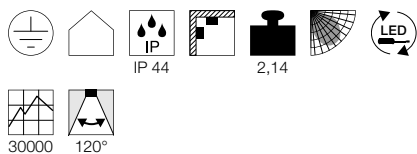

Maßzeichnung

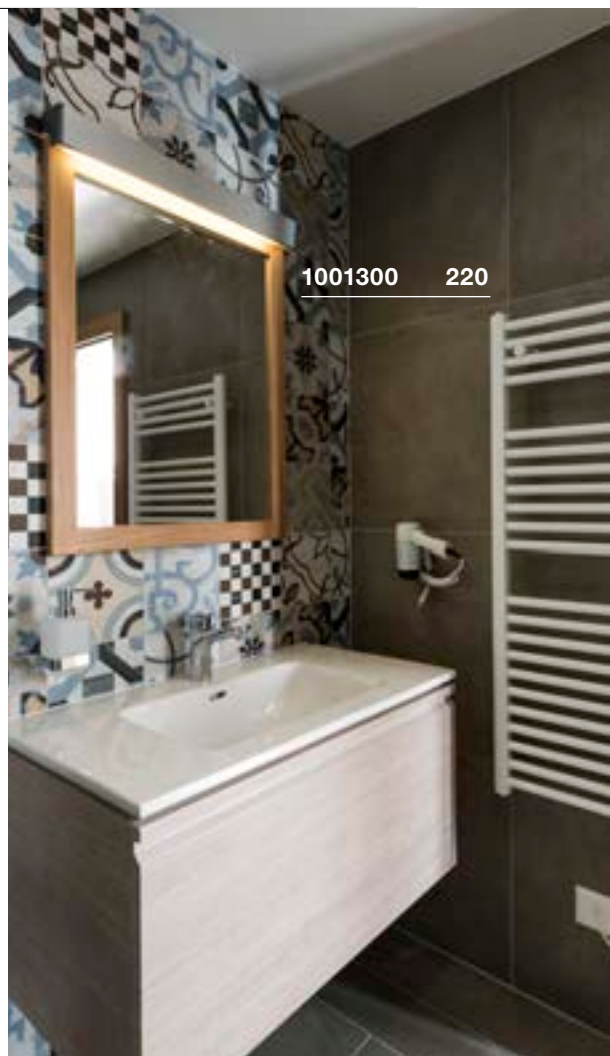
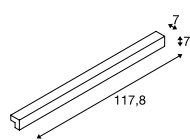

Variante	Art. Nr.
820lm 3000K CRI>80 □ weiß	1001299
820lm 3000K CRI>80 ■ matt silber	1001300
820lm 3000K CRI>80 ■ grau	1001301

Variante	Art. Nr.
1650lm 3000K CRI>80 □ weiß	1001303
1650lm 3000K CRI>80 ■ matt silber	1001304
1650lm 3000K CRI>80 ■ grau	1001305

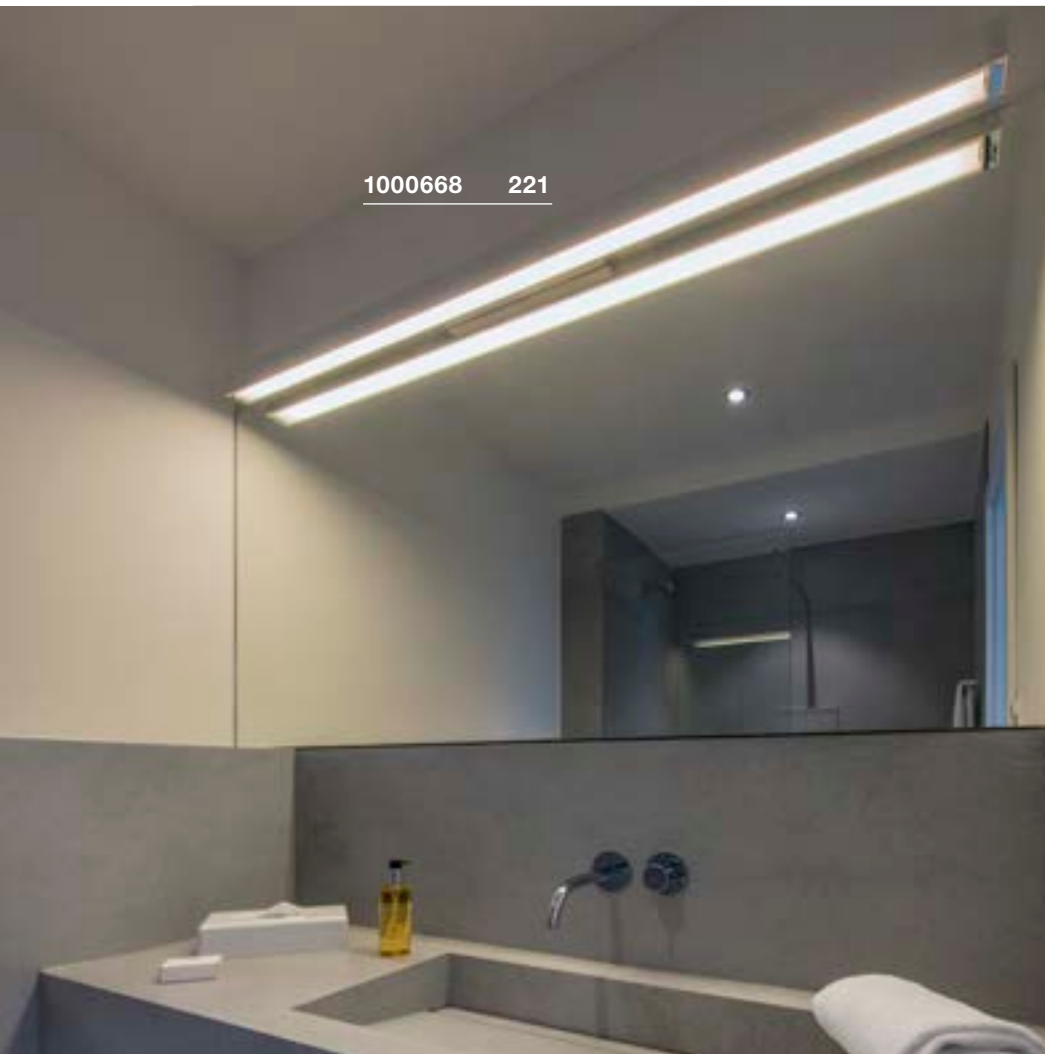

1000668 221

Q-LINE®
WL
 894

A-A++ Spektrum
A++-E

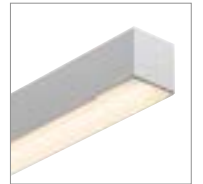
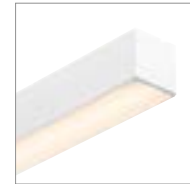

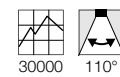
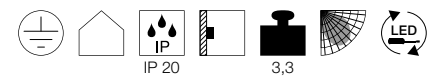

Produktangaben

220-240V ~50/60Hz | 700mA
Systemleistung: 45W
Material: Aluminium / Acryl

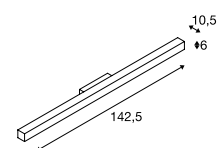

Maßzeichnung



1000670 221

Variante	Art. Nr.
3800lm 3000K CRI>80 □ weiß	1000668
3800lm 3000K CRI>80 ■ schwarz	1000669
3800lm 3000K CRI>80 ■ grau	1000670

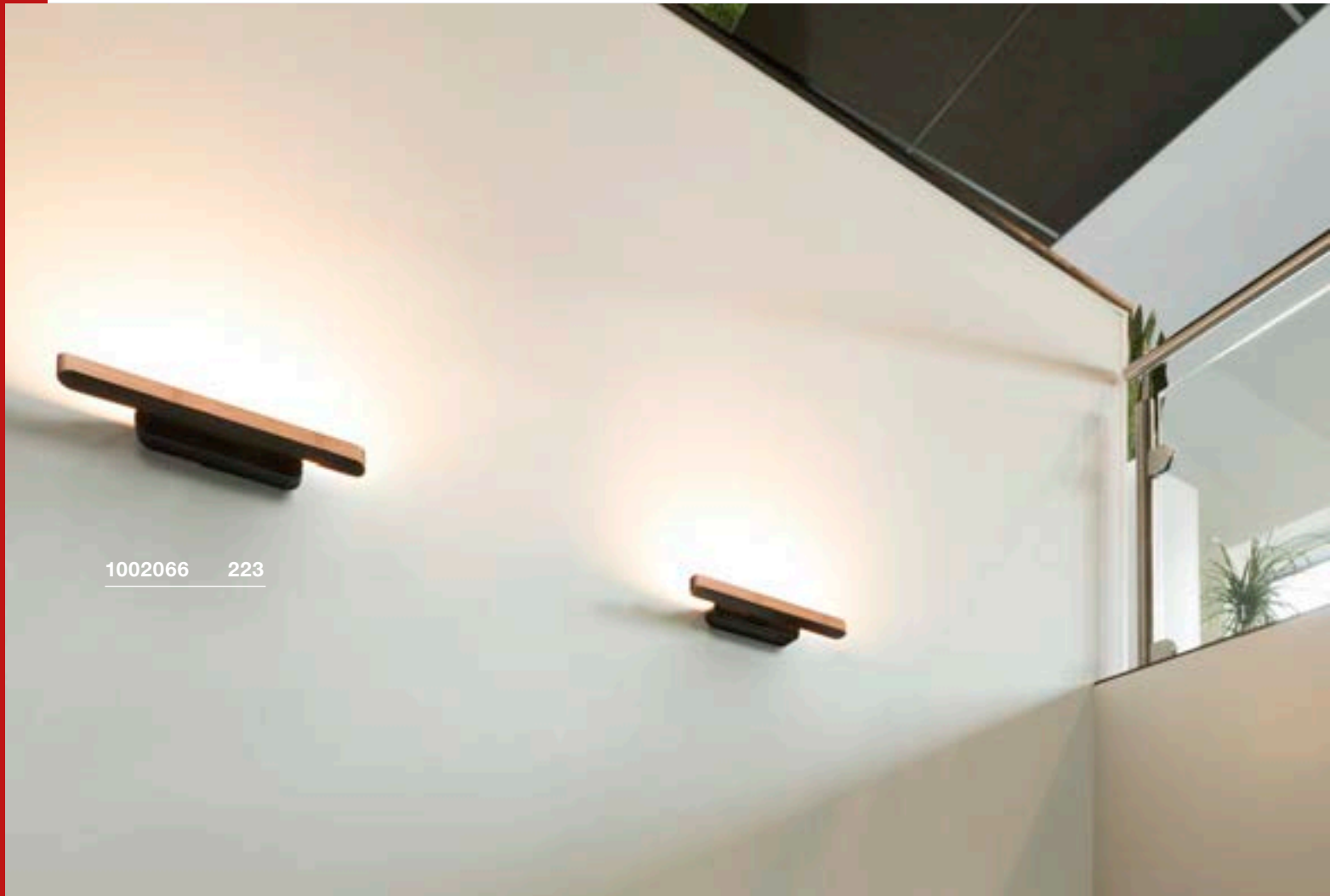

1002066 223



1002067 223



1002960 223

VINCELLI D
WL



A-A++ Spektrum A++-E



- Schlankes Design
- Leuchtenkorpus aus echtem Bambus

Produktangaben

220-240V ~50/60Hz | 350mA
Systemleistung: 11W
Material: Bambus / Stahl
Dimmbar: Triac C, Triac L

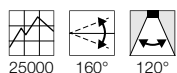
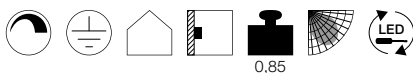

Maßzeichnung

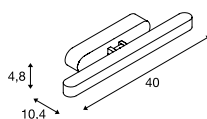

VINCELLI D
WL



A-A++ Spektrum A++-E



- Schlankes Design
- Leuchtenkorpus aus echtem Bambus

Produktangaben

220-240V ~50/60Hz | 350mA
Systemleistung: 11W
Material: Bambus / Stahl
Dimmbar: Triac C, Triac L

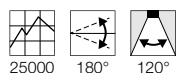
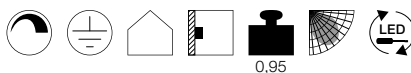

Maßzeichnung

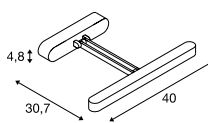

RETRATO
WL

A-A++ Spektrum A++-E



- Dreh- und schwenkbarer Leuchtenkopf

Produktangaben

220-240V ~50/60Hz
Systemleistung: 12W
Material: Aluminium / Stahl
Dimmbar: Triac C, Triac L

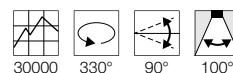
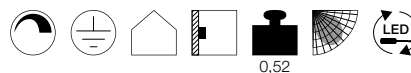

Maßzeichnung

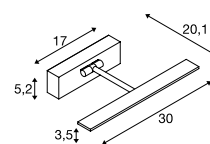

Variante	Art. Nr.
500lm 2700K CRI>80 ■ anthrazit / braun	1002066

Variante	Art. Nr.
500lm 2700K CRI>80 ■ anthrazit / braun	1002067

Variante	Art. Nr.
730lm 3000K CRI>90 ■ matt weiß / chrom	1002960
730lm 3000K CRI>90 ■ matt chrom	1002961

FILI, ROSETTE
WL, QPAR51

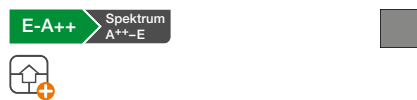

• Dreh- und schwenkbarer Leuchtenkopf

Produktangaben

220-240V ~50/60Hz
Material: Aluminium / Messing

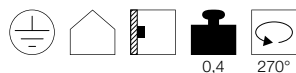

Maßzeichnung

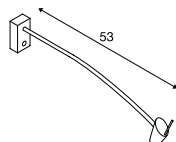

Hinweis

Dekoring 51 mm inkl.

Leuchtmittlempfehlung

LED GU10 7,2W 36°
3000K 520lm EEK=A+
8kWh/1000h
Art. Nr. 1001561



LED GU10 7,2W 36°
4000K 540lm EEK=A+
8kWh/1000h
Art. Nr. 1001564



Leuchtmittelangaben

max. 50W QPAR51

Variante	Art. Nr.
GU10 QPAR51	
■ grau	146482

FILI, KLEMME
WL, QPAR51

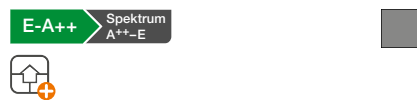

• Dreh- und schwenkbarer Leuchtenkopf

Produktangaben

230V ~50Hz
Material: Aluminium / Messing



Maßzeichnung

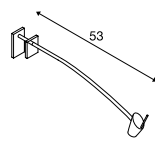

Hinweis

Klemmbereich max. 8 cm

Leuchtmittlempfehlung

LED GU10 5,5W 38°
2700K 400lm EEK=A+
6kWh/1000h
Art. Nr. 1001030



LED GU10 7,2W 36°
2700K 570lm EEK=A+
8kWh/1000h
Art. Nr. 560542



Leuchtmittelangaben

max. 50W QPAR51

Variante	Art. Nr.
GU10 QPAR51	
■ grau	146452

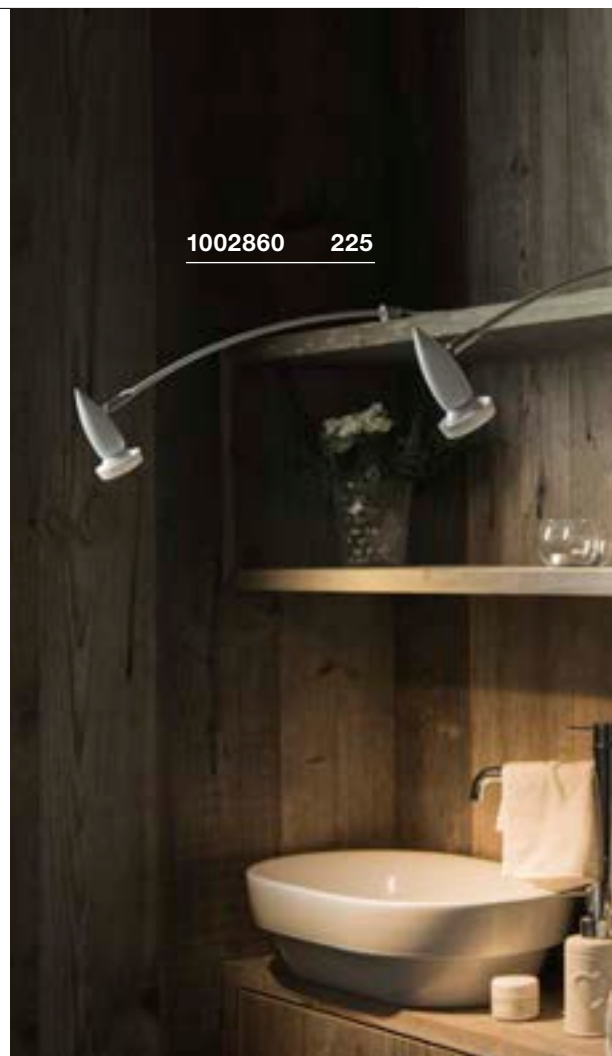



DISPLAY ADL 50
QPAR51

E-A++ Spektrum A++-E

NEW COLOR



- Dreh- und schwenkbarer Leuchtenkopf

Produktangaben

220-240V ~50/60Hz
Material: Aluminium / Messing



Maßzeichnung

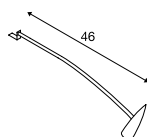

Zubehörempfehlung

- Leuchtmittel Dekoring Ø 5,7cm
Art. Nr. 151041
- Leuchtmittel Dekoring Ø 5,7cm
Art. Nr. 151049

Leuchtmittlempfehlung

- LED GU10 7,2W 36°
3000K 520lm EEK=A+
8kWh/1000h
Art. Nr. 1001563
- LED GU10 7,2W 36°
4000K 540lm EEK=A+
8kWh/1000h
Art. Nr. 1001566

Leuchtmittelangaben

max. 50W QPAR51

Variante	Art. Nr.
GU10 QPAR51	
<input type="checkbox"/> weiß	1002860
GU10 QPAR51	
<input type="checkbox"/> chrom	146332

SPOT DISPLAY
E27



A-A++ Spektrum A++-E

NEW



- Schalter an der Netzanschlußleitung
- Robust

Produktangaben

220-240V ~50/60Hz
Material: Aluminium / Stahl



Maßzeichnung

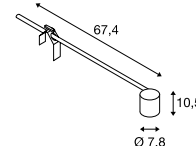

Hinweis

Schutzkontaktstecker
Klemmbereich: 10-60 mm

Leuchtmittelangaben

max. 18,5W

Variante	Art. Nr.
E27	
<input checked="" type="checkbox"/> matt schwarz	1002985
E27	
<input type="checkbox"/> matt weiß	1002986
E27	
<input type="checkbox"/> matt grau	1002987

1000734 227



1000746 + 1000748 139



1000734 227



1001464 227

ANELA
Display



A-A++ Spektrum A++-E

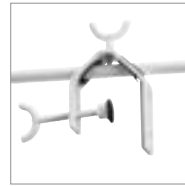

- Schalter an der Netzanschlussleitung

Produktangaben

220-240V ~50/60Hz
Systemleistung: 10W
Material: Aluminium
Dimmbar: Triac C, Triac L

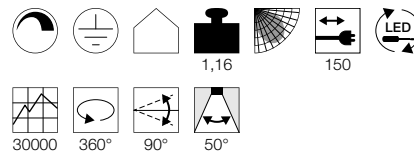

Maßzeichnung

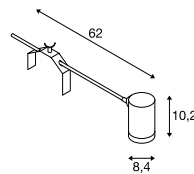

Hinweis

Eurostecker
Klemmbereich: 7-50 mm

Zubehörempfehlung

■ Rohrkit Nepro Display
Art. Nr. 146479



Variante	Art. Nr.
750lm 3000K CRI>80 ■ schwarz	1000733
750lm 3000K CRI>80 □ weiß	1000734
750lm 4000K CRI>80 ■ schwarz	1001009
750lm 4000K CRI>80 □ weiß	1001010

LENITO
WL



A-A++ Spektrum A++-E



- Einfache Installation durch Schraubklemme mit Flügelmutter

Produktangaben

220-240V ~50/60Hz | 160mA
Systemleistung: 23W
Material: Aluminium / Polycarbonat (PC)

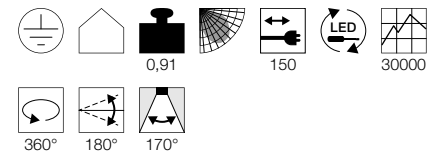

Maßzeichnung

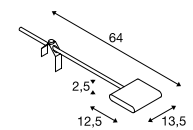

Hinweis

Schutzkontaktstecker und Schalter
Klemmbereich: 10-45 mm

Variante	Art. Nr.
2500lm 3000K CRI>80 □ weiß	1001464
2350lm 3000K CRI>80 ■ schwarz	1001465

MALO DISPLAY
WL

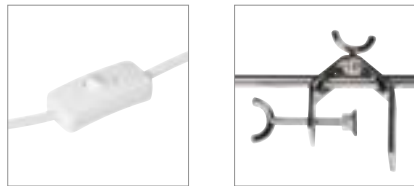

- Einfache Installation durch Schraubklemme mit Flügelmutter

Produktangaben

230V ~50Hz
Systemleistung: 23W
Material: Aluminium

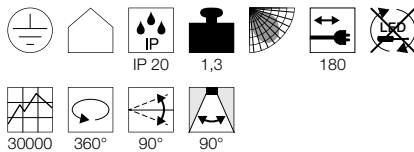

Maßzeichnung

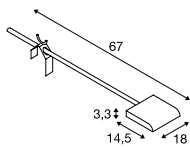

Hinweis

Eurostecker und Schalter
Klemmbereich: 15-55 mm

NEPRO DISPLAY
QT-DE12

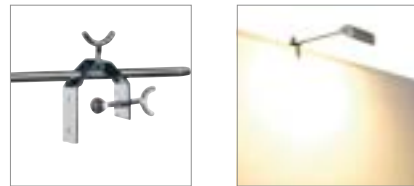

- Dreh- und schwenkbarer Kopf
- Einfache Installation durch Schraubklemme mit Flügelmutter

Produktangaben

230V ~50Hz
Material: Aluminium

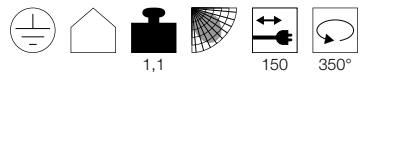

Maßzeichnung

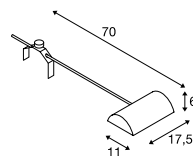

Hinweis

Schutzkontaktstecker und Schalter
Klemmbereich: 15-55 mm

Zubehörempfehlung

■ Rohrkit Nepro Display
Art. Nr. 146479

Leuchtmittlempfehlung

R7s 118mm 6,5W
3000K 806lm EEK=A++
7kWh/1000h
Art. Nr. 551893

LED R7s 118mm 14W
3000K 2000lm EEK=A++
14kWh/1000h
Art. Nr. 1002135

Leuchtmittelangaben

max. 300W QT-DE12

Variante	Art. Nr.
1600lm 4000K CRI>80 ■ grau	1001857
1600lm 4000K CRI>80 ■ weiß / chrom	1001858

Variante	Art. Nr.
R7s 118mm QT-DE12 ■ grau / chrom	146472





170401 229

DISPLAY

A-A++ Spektrum
A++-ELED
INSIDE

- Dreh- und schwenkbarer Leuchtenkopf
- Einfache Installation durch Schraubklemme

Produktangaben

230V ~50Hz | 24V DC

Systemleistung: 16W

Material: Aluminium / Kunststoff

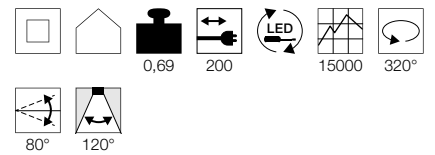

1001857 228

Maßzeichnung

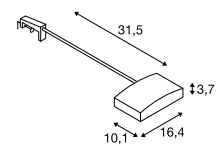

Hinweis

Eurostecker

Klemmbereich: 5-55 mm

Variante	Art. Nr.
1100lm 4000K CRI>80	
■ grau	170401
1060lm 3000K CRI>80	
■ grau	170402

ALLES GUTE KOMMT VON OBEN.

DECKENLEUCHTEN
FÜR FLEXIBLE BELEUCHTUNG.

Deckenleuchten sind das Herzstück jeder Raumbelichtung. Mit ihrer Strahlkraft bringen sie eine warme Atmosphäre in jeden Raum. Angepasst an das Raumkonzept, können Sie die Leuchten individuell ausrichten und so auch von ganz oben beeindruckende Lichtakzente setzen.

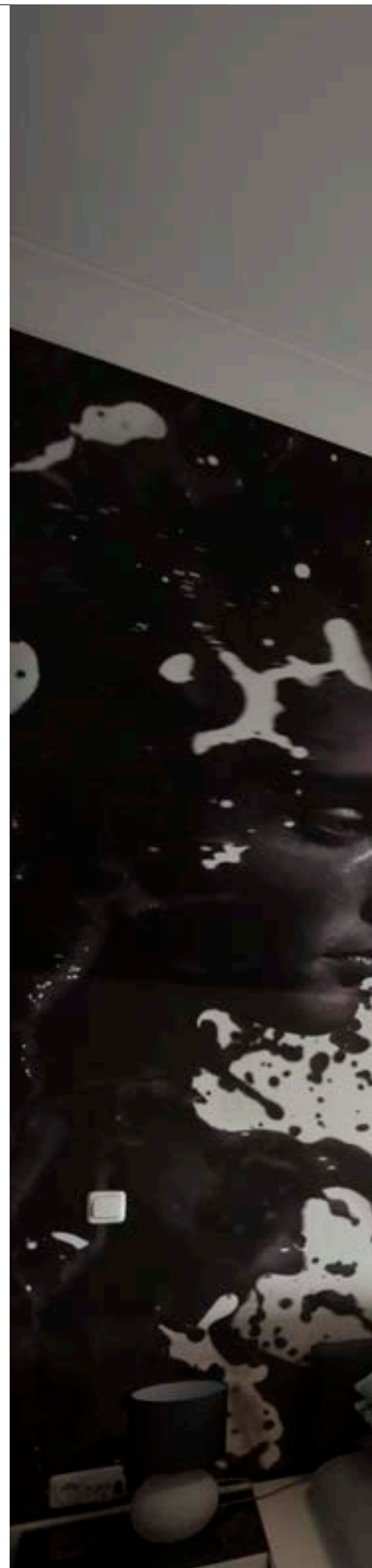



156050 237

1002968 241



DECKENLEUCHTEN

 234	 235	 235	 235	 236	 237	 237	 238
 238	 240	 240	 240	 241	 241	 246	 247
 248	 248	 248	 249	 250	 251	 251	 251
 252	 252	 252	 253	 254	 255	 256	 257
 257	 257	 258	 258	 259	 259	 260	 260
 260	 262	 263	 263	 263	 264	 264	 265
 265	 266	 266	 266	 267	 267	 268	 268
 269	 269	 270	 271	 271	 271	 272	 272
 273	 273	 274	 274	 275	 275	 276	 276
 277	 277	 277					

SLV FENDA. MIX & MATCH.

MIX & MATCH

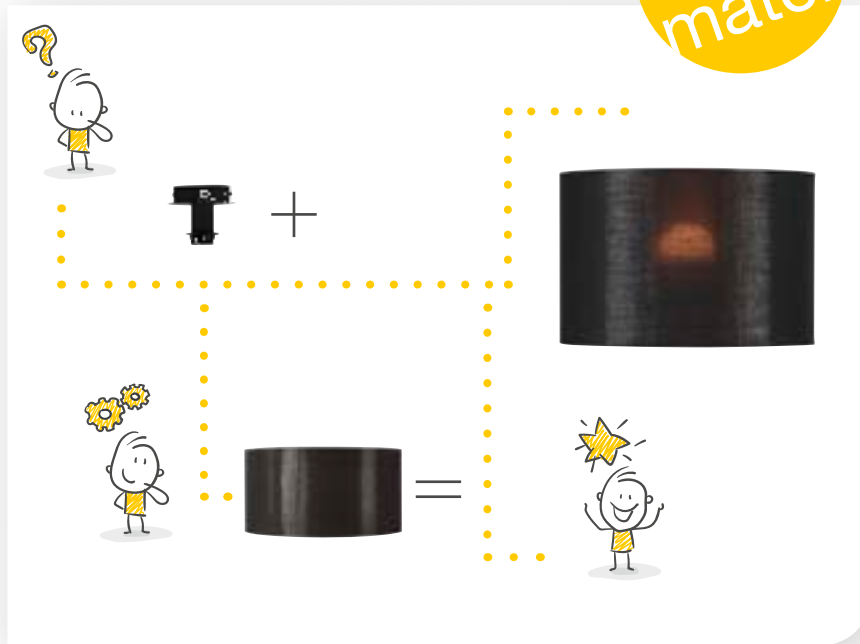

FENDA
Deckenrosette, E27



E-A++ Spektrum
A++-E



- Durch Auswahl der Leuchtschirme individuell gestaltbar

Produktangaben

230V ~50Hz
Material: Stahl



0,3

Maßzeichnung

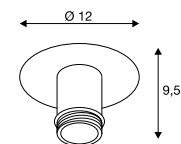

Leuchtmittelempfehlung

LED E27 14,5W 200°
2700K 1521lm EEK=A+
15kWh/1000h
Art. Nr. 560422



LED E27 7W 330°
2700K 806lm EEK=A+
8kWh/1000h
Art. Nr. 1001038



Leuchtmittelangaben

max. 60W

Variante	Art. Nr.
E27	
■ schwarz	155550
E27	
□ weiß	155551
E27	
■ chrom	155552

155552 + 156122 234 + 235



FENDA
Ø 30 cm, rund



- Durch Auswahl einer geeigneten Leuchtenbasis individuell gestaltbar

Produktangaben

Material: Textil / Stahl



Maßzeichnung

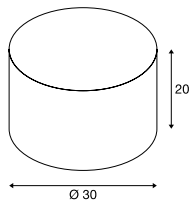

Hinweis

max. 60W
Acrylglasabdeckung (155570), um den Schirm einseitig zu schließen als Zubehör erhältlich.



Zubehörempfehlung

Acrylglasabdeckung
Art. Nr. 155570

Variante	Art. Nr.
<input type="checkbox"/> weiß	155582
<input type="checkbox"/> beige	155583
<input type="checkbox"/> schwarz / kupfer	155592

FENDA
Ø 45 cm, rund



- Durch Auswahl einer geeigneten Leuchtenbasis individuell gestaltbar

Produktangaben

Material: Textil / Stahl

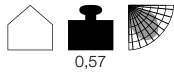

Maßzeichnung

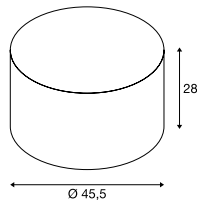

Hinweis

max. 60W
Acrylglasabdeckung (156100), um den Schirm einseitig zu schließen als Zubehör erhältlich.



Zubehörempfehlung

Acrylglasabdeckung
Art. Nr. 156100

Variante	Art. Nr.
<input type="checkbox"/> weiß	156111
<input type="checkbox"/> beige	156113
<input type="checkbox"/> schwarz / kupfer	156122

FENDA
Ø 70 cm, rund

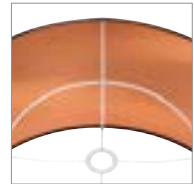
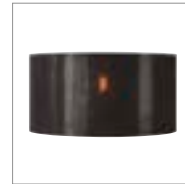

- Durch Auswahl einer geeigneten Leuchtenbasis individuell gestaltbar

Produktangaben

Material: Textil / Stahl



Maßzeichnung

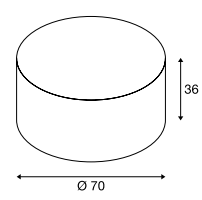

Hinweis

max. 60W
Acrylglasabdeckung (1000957), um den Schirm einseitig zu schließen als Zubehör erhältlich.



Zubehörempfehlung

Acrylglasabdeckung
Art. Nr. 1000957

Variante	Art. Nr.
<input type="checkbox"/> weiß	1000579
<input checked="" type="checkbox"/> schwarz / kupfer	1000580

ACCANTO
CL, E27

882

E-A++

Spektrum
A++-E

1002945 236

NEW



- Acrylabdeckung an der Unterseite des Schirms

Produktangaben

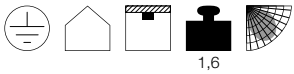
220-240V ~50/60Hz
Material: Stahl / Textil

1,6

Maßzeichnung

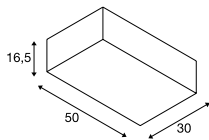

Leuchtmittelangaben

2x max. 40W

Variante	Art. Nr.
E27 ■ weiß / schwarz	1002944
E27 □ weiß / weiß	1002945

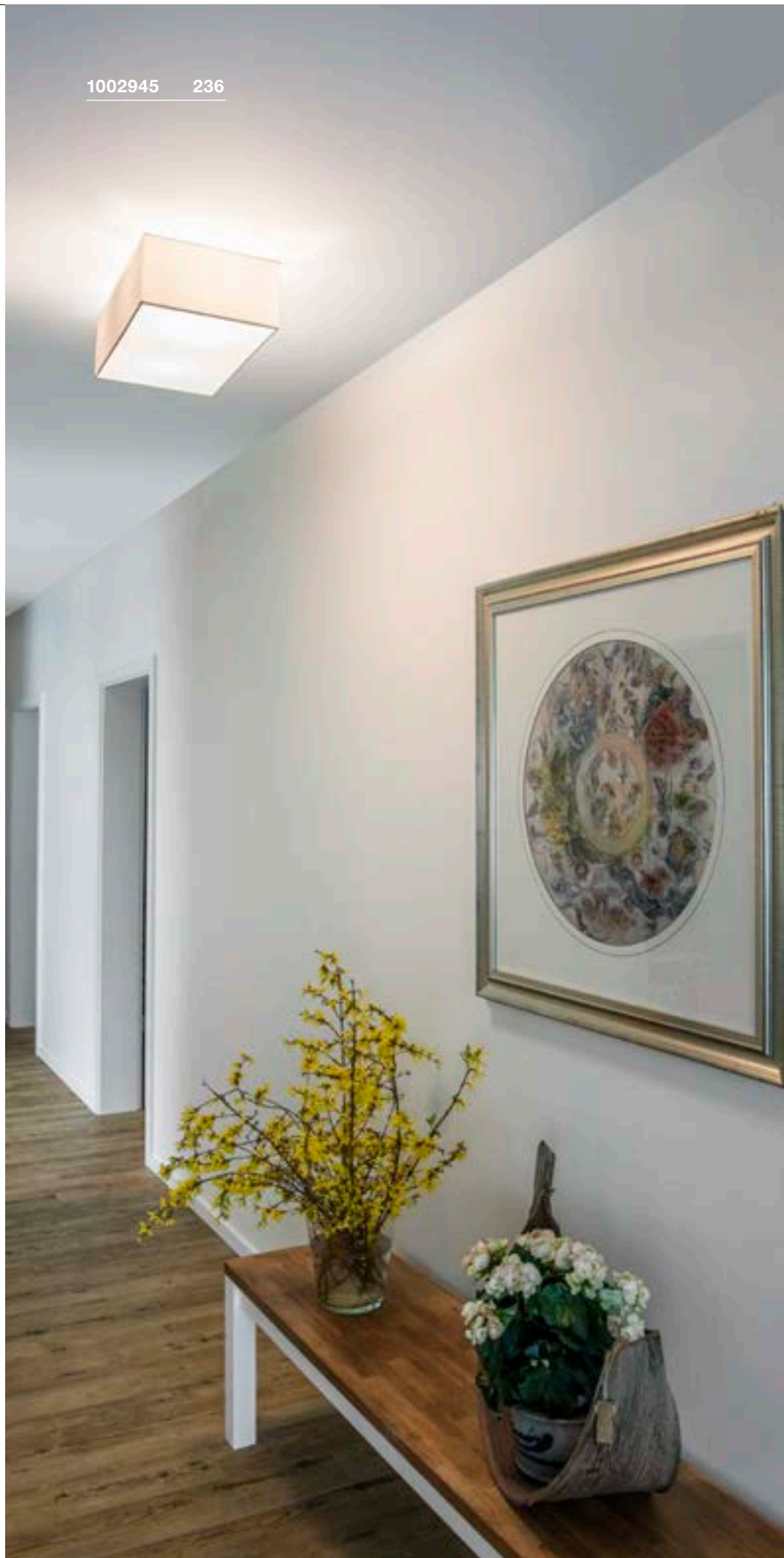



156050 237

TENORA
CL, E27



A-A++ Spektrum A++-E

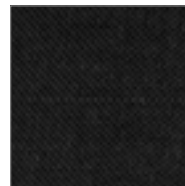

Produktangaben

230V ~50Hz
Material: Stahl / Textil

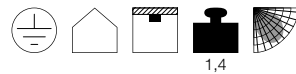

1,4

Maßzeichnung

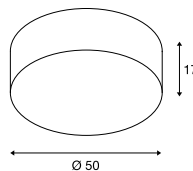

Hinweis

Rosette: Ø 12 cm

Leuchtmittlempfehlung

LED E27 9,1W 240°
2700K 760lm EEK=A+
10kWh/1000h
Art. Nr. 560402



LED E27 7W 280°
2200-2700K 830lm EEK=A++
7kWh/1000h
Art. Nr. 1002126



Leuchtmittelangaben

3x max. 23W
L: 14,8 cm max.

Variante	Art. Nr.
E27	
■ schwarz	156050
E27	
□ weiß	156051

SOPRANA
CL, E27



E-A++ Spektrum A++-E



Produktangaben

230V ~50Hz
Material: Stahl / Textil

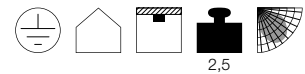

2,5

Maßzeichnung

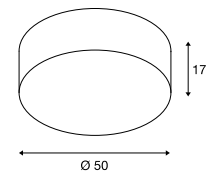

Hinweis

Rosette: Ø 15 cm

Leuchtmittlempfehlung

LED E27 7W 280°
2700K 790lm EEK=A++
7kWh/1000h
Art. Nr. 1002124



LED E27 7W 280°
2200-2700K 830lm EEK=A++
7kWh/1000h
Art. Nr. 1002126



Leuchtmittelangaben

3x max. 60W
L: 20 cm max.

Variante	Art. Nr.
E27	
□ weiß	155372
E27	
■ beige	155373

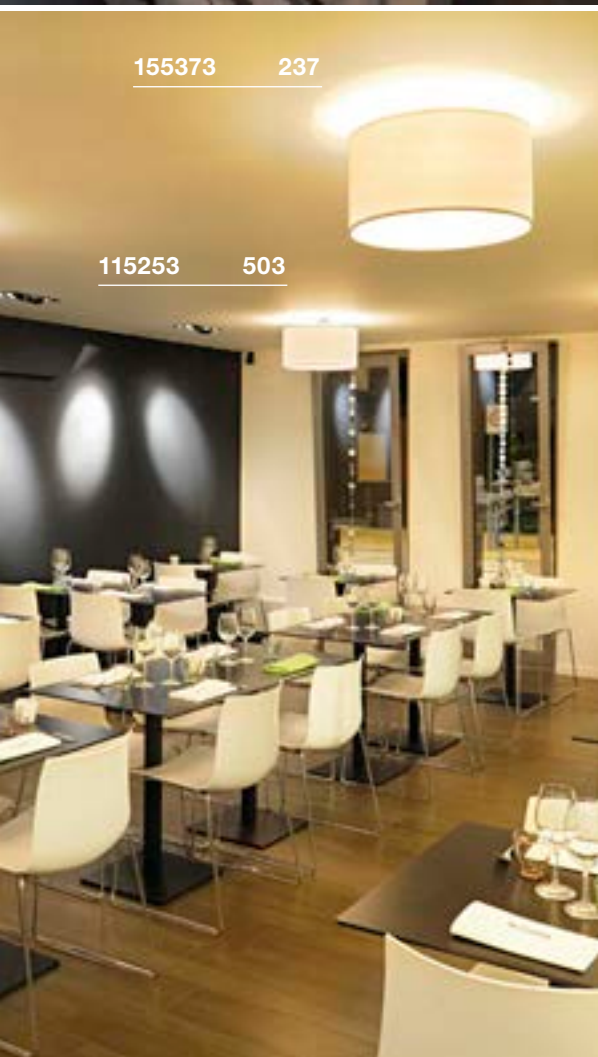

155373 237

115253 503

BATO 45
CW, E27



E-A++ Spektrum
A++-E



BATO 45
CW



A-A++ Spektrum
A++-E



Produktangaben

220-240V ~50/60Hz
Material: Aluminium / Stahl

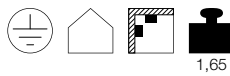

1,65

Produktangaben

220-240V ~50/60Hz | 700mA
Systemleistung: 30W
Material: Aluminium / Polymethylacrylat (PMMA)
Dimmbar: Triac C

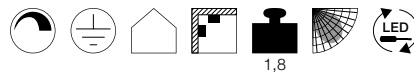

1,8

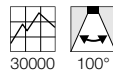

30000 100°

Maßzeichnung

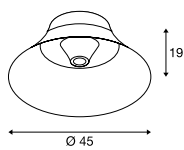

Maßzeichnung

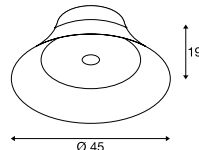

Leuchtmittlempfehlung

LED E27 7,1W 330°
2700K 806lm EEK=A+
8kWh/1000h
Art. Nr. 1001756



LED E27 7W 280°
2200-2700K 830lm EEK=A++
7kWh/1000h
Art. Nr. 1002126



Leuchtmittelangaben

max. 60W

Variante	Art. Nr.
E27	
■ schwarz	1000443
E27	
■ matt messing	1000445

Variante	Art. Nr.
1450lm 2700K CRI>80	
■ schwarz	1000437
1900lm 2500K CRI>80	
■ matt messing	1000442

1000442 238



1000445 238



1000445 238

1000442 238



PLASTRA
CL



A-A++ Spektrum
A++-E



- Individuell gestaltbar mit Farben, Stickern & mehr

Produktangaben

220-240V ~50/60Hz | 350mA
Systemleistung: 15W
Material: Gips / Stahl
Dimmbar: Triac C, Triac L

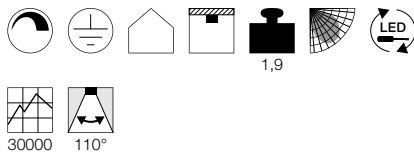

Maßzeichnung

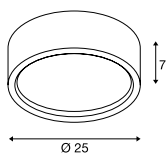

PLASTRA 105
CL, E27



E-A++ Spektrum
A++-E

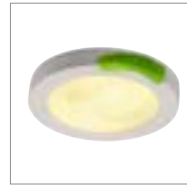

- Individuell gestaltbar mit Farben, Stickern & mehr

Produktangaben

220-240V ~50/60Hz
Material: Gips / Glas

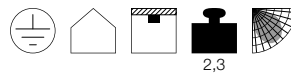

Maßzeichnung

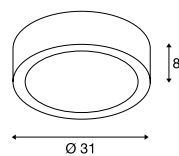

Leuchtmittelpfehlung

E27 9W 240°
3000K 810lm EEK=A+
10kWh/1000h
Art. Nr. 1001031



LED E27 12W 240°
3000K 1055lm EEK=A+
12kWh/1000h
Art. Nr. 1001032



Leuchtmittelangaben

2x max. 25W
Ø: 5 cm max. L: 14 cm max.

Variante	Art. Nr.
E27	
□ weiß / matt transparent	148001

PLASTRA 104
CL, E27



E-A++ Spektrum
A++-E

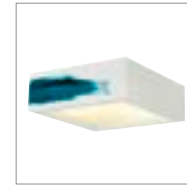

- Individuell gestaltbar mit Farben, Stickern & mehr

Produktangaben

220-240V ~50/60Hz
Material: Gips / Glas

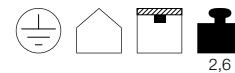

Maßzeichnung

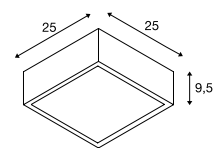

Leuchtmittelpfehlung

E27 11W
3000K 600lm EEK=A
11kWh/1000h
Art. Nr. 508211



LED E27 12W 240°
3000K 1055lm EEK=A+
12kWh/1000h
Art. Nr. 1001032



Leuchtmittelangaben

2x max. 25W
Ø: 5 cm max. L: 14 cm max.

Variante	Art. Nr.
E27	
□ weiß / matt transparent	148002



1002968 241

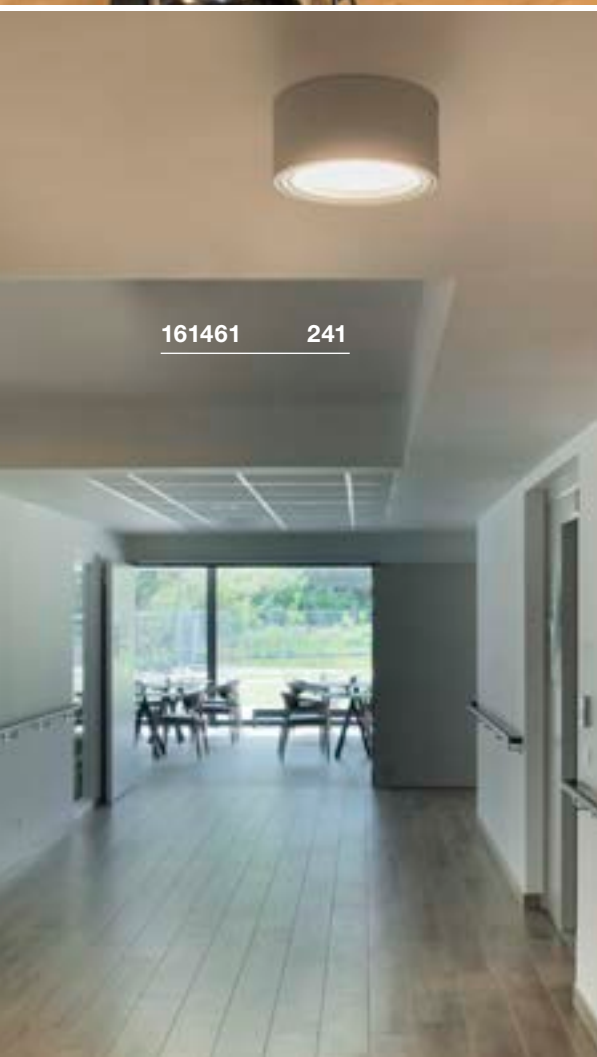

161461 241

FERA 25
CL, DALI

A-A++ Spektrum A++-E



- Lichtfarbe schaltbar

Produktangaben

220-240V ~50/60Hz | 500mA
Systemleistung: 19,5W
Material: Polycarbonat (PC) / Polymethylacrylat (PMMA)
Dimmbar: Dali

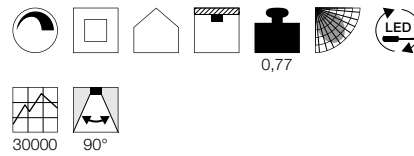

Maßzeichnung

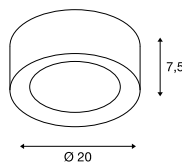

FERA 25
CL

A-A++ Spektrum A++-E



Produktangaben

100-240V ~50/60Hz | 550mA
Systemleistung: 21W
Material: Aluminium / Polystrol (PS)

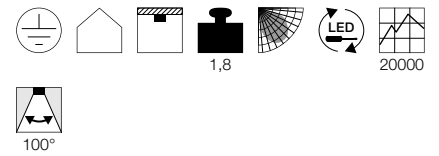

Maßzeichnung

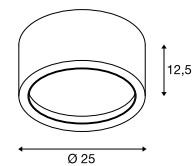





Variante	Art. Nr.
1580/1650lm 3000/4000K CRI>80	
□ matt weiß / gefrosted	1002967
1580/1650lm 3000/4000K CRI>80	
■ matt schwarz / gefrosted	1002968

Variante	Art. Nr.
2000lm 3000K CRI>80	
□ weiß	161461
2000lm 3000K CRI>80	
■ grau	161464
2000lm 3000K CRI>80	
■ schwarz	1001939

MEDO LEUCHTENSERIE.





DECKEN- ODER PENDELLEUCHTE.

	MEDO 30 CL, 1-10V	MEDO 40 CL, 1-10V	MEDO 60 CL, 1-10V	MEDO 90 CL, 1-10V
Beispiel				
Leuchtmittel				
Größe	Ø: 30 cm	Ø: 40 cm	Ø: 60 cm	Ø: 90 cm
Lichtstärke	1000lm	2000lm	3500lm	11000lm
UGR	25	25	22	25
Dimmbar	1-10V	1-10V	1-10V	1-10V
Abhängeset	1,5 m 5 m	1,5 m 5 m	1,5 m 5 m	1,5 m 5 m

	MEDO 30 CL, TRIAC	MEDO 40 CL, TRIAC	
Beispiel			
Leuchtmittel			
Größe-Ø	Ø: 30 cm	Ø: 40 cm	
Lichtstärke	1200lm	2125lm	
UGR	25	25	
Dimmbar	Triac C, Triac L	Triac C, Triac L	
Abhängeset (exkl.)	1,5 m 5 m	1,5 m 5 m	



Diese MEDO Variante wird mit TRIAC Dimmer gedimmt!

	MEDO 60 CL, square, 1-10V	MEDO 60 CL, square, DALI
Beispiel		
Leuchtmittel		
Größe	B L: 60 cm	B L: 60 cm
Lichtstärke	3300 lm	3300 lm
UGR	22	22
Dimmbar	1-10V	Dali
Abhängeset	1,5 m 5 m	1,5 m 5 m



MEDO LEUCHTENSERIE.

DECKEN- ODER PENDELLEUCHTE.

	MEDO 30 CORONA CW, TRIAC	MEDO 40 CORONA CW, TRIAC	MEDO 60 CORONA CW, TRIAC	MEDO 90 CORONA CL, TRIAC
Beispiel				
Leuchtmittel				
Größe	Ø: 30 cm	Ø: 40 cm	Ø: 60 cm	Ø: 90 cm
Lichtstärke	Down: 1230/1280lm Up: 20lm	Down: 2750/2900lm Up: 50lm	Down: 4350/4750lm Up: 120lm	Down: 9500/10100lm Up: 125lm
UGR	25	25	25	25
Dimmbar	Triac C	Triac C	Triac C	Triac C
Abhängeset	1,5 m 5 m	1,5 m 5 m	1,5 m 5 m	1,5 m 5 m

	MEDO 30 CORONA CW, DALI	MEDO 40 CORONA CW, DALI	MEDO 60 CORONA CW, DALI	MEDO 90 CORONA CL, DALI
Beispiel				
Leuchtmittel				
Größe	Ø: 30 cm	Ø: 40 cm	Ø: 60 cm	Ø: 90 cm
Lichtstärke	Down: 1230/1280lm Up: 20lm	Down: 2750/2900lm Up: 50lm	Down: 4350/4750lm Up: 120lm	Down: 9500/10100lm Up: 125lm
UGR	25	25	25	25
Dimmbar	DALI	DALI	DALI	DALI
Abhängeset	1,5 m 5 m	1,5 m 5 m	1,5 m 5 m	1,5 m 5 m



Corona Effekt Diese MEDO Varianten verfügen über einen homogenen indirekten Lichtaustritt nach oben.

Farbtemperatur – Bei dieser MEDO Variante können Sie die Farbtemperatur selber wählen. Durch den Schalter auf der Rückseite kann zwischen 3000K und 4000K gewählt werden.

MEDO 30
CL, TRIAC



A-A++ Spektrum
A++-E



135070 247



135250 246



135120 248

135020 246

Produktangaben

220-240V ~50/60Hz | 350mA
Systemleistung: 16W
Material: Aluminium / Polymethylacrylat (PMMA)
Dimmbar: Triac C, Triac L

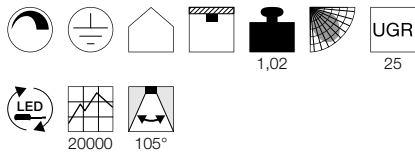

Maßzeichnung

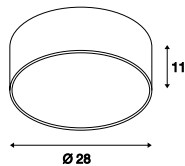

Hinweis

Abhängeset exkl.

Zubehörepfehlung

- Abhängeset 1,5m
Art. Nr. 135250
- Abhängeset 1,5m
Art. Nr. 135251
- Abhängeset 1,5m
Art. Nr. 135254
- Abhängeset 5m
Art. Nr. 1001950
- Abhängeset 5m
Art. Nr. 1001951
- Abhängeset 5m
Art. Nr. 1001952

Variante	Art. Nr.
1200lm 3000K CRI>80	
<input checked="" type="checkbox"/> schwarz	135020
1200lm 3000K CRI>80	
<input type="checkbox"/> weiß	135021
1200lm 3000K CRI>80	
<input checked="" type="checkbox"/> grau	135024
1200lm 3000K CRI>80	
<input checked="" type="checkbox"/> rot	135026



135071 247

MEDO 40
CL, TRIAC



A-A++ Spektrum
A++-E



LED
INSIDE



Produktangaben

220-240V ~50/60Hz | 700mA

Systemleistung: 31W

Material: Aluminium / Polymethylacrylat (PMMA)

Dimmbar: Triac C, Triac L

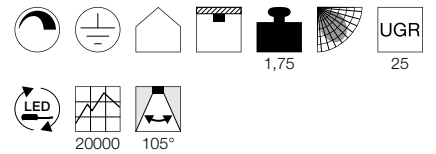

Maßzeichnung

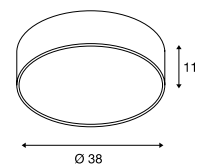

Hinweis

Abhängeset exkl.

Zubehöreffahrung

- Abhängeset 1,5m
Art. Nr. 135250
- Abhängeset 1,5m
Art. Nr. 135251
- Abhängeset 1,5m
Art. Nr. 135254
- Abhängeset 5m
Art. Nr. 1001950
- Abhängeset 5m
Art. Nr. 1001951
- Abhängeset 5m
Art. Nr. 1001952

Variante	Art. Nr.
2125lm 3000K CRI>80	
■ schwarz	135070
2125lm 3000K CRI>80	
□ weiß	135071
2125lm 3000K CRI>80	
■ grau	135074
2125lm 3000K CRI>80	
■ rot	135076

MEDO 30
CL, 1-10V



A-A++ Spektrum A++-E



Produktangaben

220-240V ~50/60Hz | 350mA
Systemleistung: 15W
Material: Aluminium / Polymethylacrylat (PMMA)
Dimmbar: 1-10V

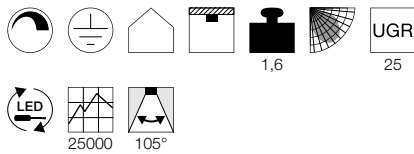

Maßzeichnung

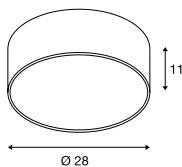

Hinweis

Abhängeset exkl.

Zubehörempfehlung

- Abhängeset 1,5m
Art. Nr. 135250
- Abhängeset 1,5m
Art. Nr. 135251
- Abhängeset 1,5m
Art. Nr. 135254
- Abhängeset 5m
Art. Nr. 1001950
- Abhängeset 5m
Art. Nr. 1001951
- Abhängeset 5m
Art. Nr. 1001952

Variante	Art. Nr.
1000lm 3000K CRI>80 ■ schwarz	1000855
1000lm 3000K CRI>80 □ weiß	1000856
1000lm 3000K CRI>80 ■ grau	1000857

MEDO 40
CL, 1-10V



A-A++ Spektrum A++-E



Produktangaben

120-240V ~50/60Hz | 700mA
Systemleistung: 29W
Material: Aluminium / Polymethylacrylat (PMMA)
Dimmbar: 1-10V

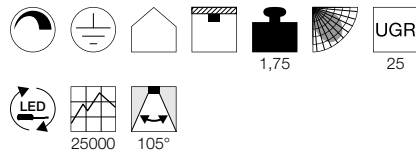

Maßzeichnung

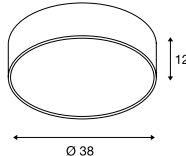

Hinweis

Abhängeset exkl.

Zubehörempfehlung

- Abhängeset 1,5m
Art. Nr. 135250
- Abhängeset 1,5m
Art. Nr. 135251
- Abhängeset 1,5m
Art. Nr. 135254
- Abhängeset 5m
Art. Nr. 1001950
- Abhängeset 5m
Art. Nr. 1001951
- Abhängeset 5m
Art. Nr. 1001952

Variante	Art. Nr.
2000lm 3000K CRI>80 ■ schwarz	1000864
2000lm 3000K CRI>80 □ weiß	1000865
2000lm 3000K CRI>80 ■ grau	1000866

MEDO 60
CL, 1-10V



A-A++ Spektrum A++-E



Produktangaben

100-240V ~50/60Hz | 1000mA
Systemleistung: 40W
Material: Aluminium / Polymethylacrylat (PMMA)
Dimmbar: 1-10V

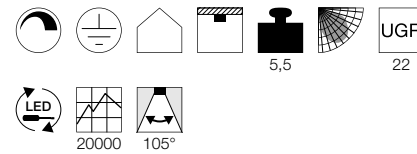

Maßzeichnung

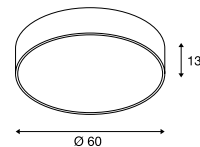

Hinweis

Abhängeset exkl.

Zubehörempfehlung

- Abhängeset 1,5m
Art. Nr. 135250
- Abhängeset 1,5m
Art. Nr. 135251
- Abhängeset 1,5m
Art. Nr. 135254
- 1-10V Dimming
Art. Nr. 470505
- Abhängeset 5m
Art. Nr. 1001950
- Abhängeset 5m
Art. Nr. 1001951
- Abhängeset 5m
Art. Nr. 1001952

Variante	Art. Nr.
3500lm 3000K CRI>80 ■ schwarz	135120
3500lm 3000K CRI>80 □ weiß	135121
3500lm 3000K CRI>80 ■ grau	135124
3500lm 3000K CRI>80 ■ rot	135126



135121 248



135021 246

135171 249

135121 248



MEDO 90
CL, 1-10V



A-A++ Spektrum A++-E



LED INSIDE



Produktangaben

220-240V ~50/60Hz | 2900mA
Systemleistung: 119W
Material: Aluminium / Polymethylacrylat (PMMA)
Dimmbar: 1-10V

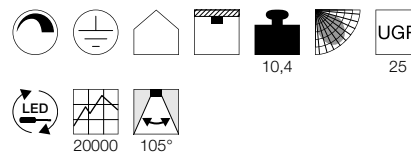

Maßzeichnung

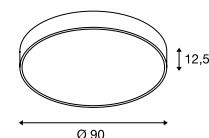

Hinweis

Abhängeset exkl.

Zubehöreffempfung

- Abhängeset 1,5m
Art. Nr. 135250
- Abhängeset 1,5m
- Abhängeset 1,5m
- Abhängeset 1,5m
- Art. Nr. 135254
- 1-10V Dimming
- Art. Nr. 470505
- Abhängeset 5m
- Art. Nr. 1001950
- Abhängeset 5m
- Art. Nr. 1001951
- Abhängeset 5m
- Art. Nr. 1001952

Variante	Art. Nr.
11000lm 3000K CRI>80	
<input checked="" type="checkbox"/> schwarz	135170
11000lm 3000K CRI>80	
<input type="checkbox"/> weiß	135171
11000lm 3000K CRI>80	
<input checked="" type="checkbox"/> grau	135174
11000lm 3000K CRI>80	
<input checked="" type="checkbox"/> rot	135176

MEDO 30 CORONA
CW, TRIAC

891

A-A++ Spektrum
A++-ELED
INSIDE

- Mit Corona Effekt
- Farbtemperatur (3000K/4000K) über Schalter einstellbar

Produktangaben

220-240V ~50/60Hz | 350mA
Systemleistung: 15W
Material: Aluminium / Polycarbonat (PC)
Dimmbar: Triac C

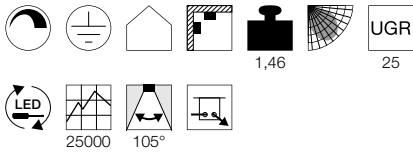

Maßzeichnung

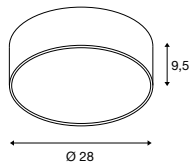

Hinweis

Abhängeset exkl.

Zubehörempfehlung

 Abhängeset 1,5m

Art. Nr. 135250

 Abhängeset 1,5m

Art. Nr. 135251

 Abhängeset 1,5m

Art. Nr. 135254

 Abhängeset 5m

Art. Nr. 1001950

 Abhängeset 5m

Art. Nr. 1001951



 Abhängeset 5m

Art. Nr. 1001952

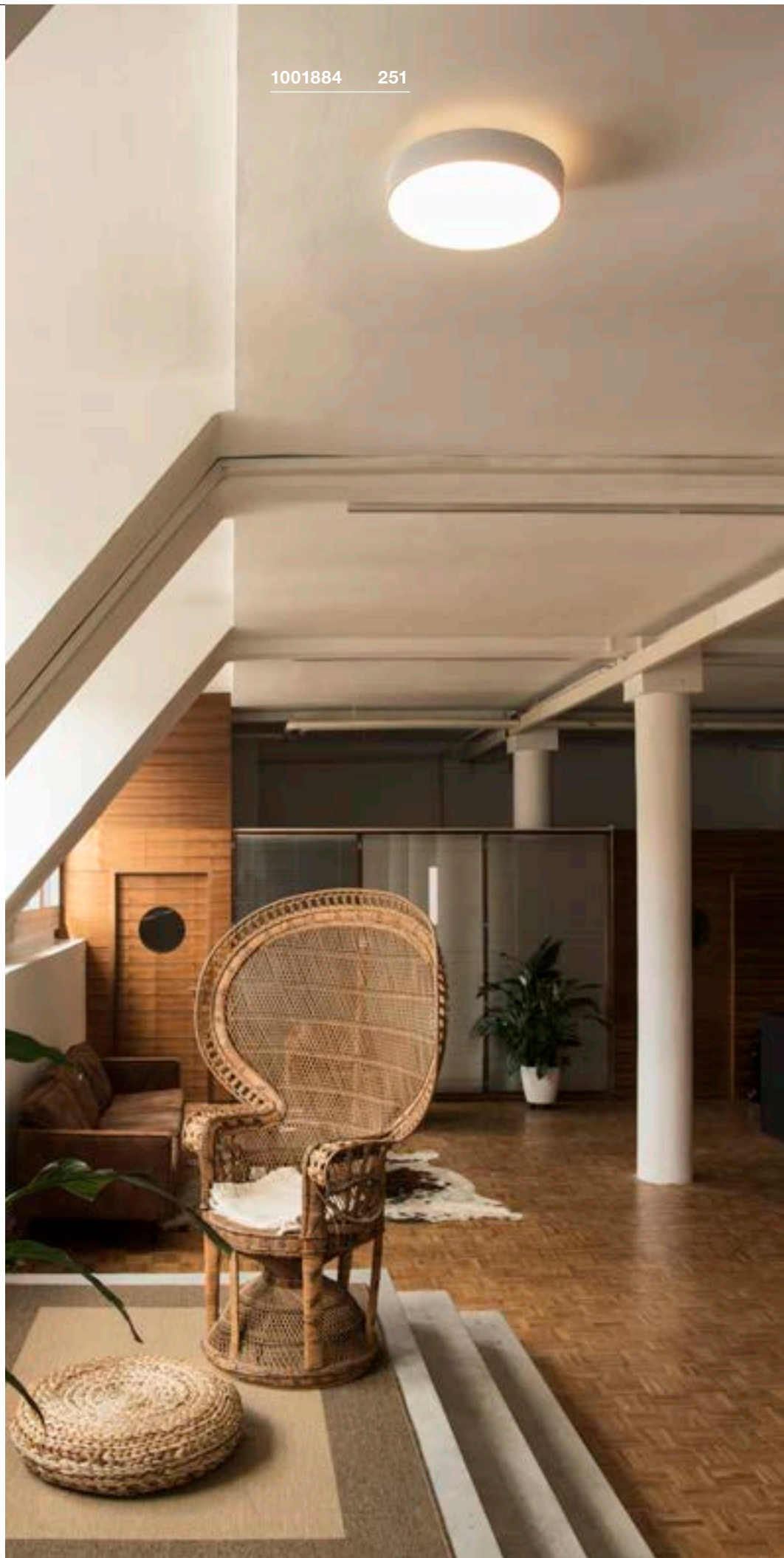

Variante	Art. Nr.
Down: 1230/1280lm 3000/4000K CRI>80 Up: 20lm 3000/4000K CRI>80	<input checked="" type="checkbox"/> schwarz 1001877
Down: 1230/1280lm 3000/4000K CRI>80 Up: 20lm 3000/4000K CRI>80	<input type="checkbox"/> weiß 1001881
Down: 1230/1280lm 3000/4000K CRI>80 Up: 20lm 3000/4000K CRI>80	<input checked="" type="checkbox"/> grau 1001882

1001884 251



MEDO 40 CORONA
CW, TRIAC



A-A++ Spektrum A++-E

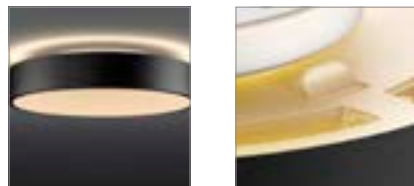

- Mit Corona Effekt
- Farbtemperatur (3000K/4000K) über Schalter einstellbar

Produktangaben

220-240V ~50/60Hz | 700mA
Systemleistung: 30W
Material: Aluminium / Polycarbonat (PC)
Dimmbar: Triac C

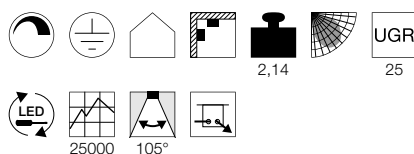

Maßzeichnung

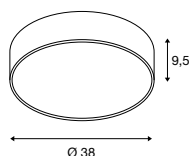

Hinweis

Abhängeset exkl.

Zubehöreffahrung

- Abhängeset 1,5m
Art. Nr. 135250
- Abhängeset 1,5m
Art. Nr. 135251
- Abhängeset 1,5m
Art. Nr. 135254
- Abhängeset 5m
Art. Nr. 1001950
- Abhängeset 5m
Art. Nr. 1001951
- Abhängeset 5m
Art. Nr. 1001952

Variante	Art. Nr.
Down: 2750/2900lm 3000/4000K CRI>80 Up: 50lm 3000/4000K CRI>80	
■ schwarz	1001883
Down: 2750/2900lm 3000/4000K CRI>80 Up: 50lm 3000/4000K CRI>80	
□ weiß	1001884
Down: 2750/2900lm 3000/4000K CRI>80 Up: 50lm 3000/4000K CRI>80	
■ grau	1001885

MEDO 60 CORONA
CW, TRIAC



A-A++ Spektrum A++-E

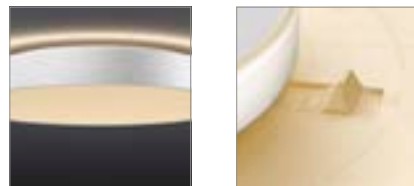

- Mit Corona Effekt
- Farbtemperatur (3000K/4000K) über Schalter einstellbar

Produktangaben

220-240V ~50/60Hz | 1050mA
Systemleistung: 40W
Material: Aluminium / Polycarbonat (PC)
Dimmbar: Triac C

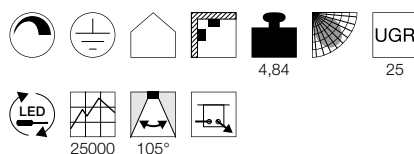

Maßzeichnung

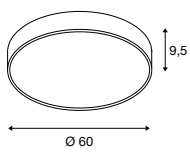

Hinweis

Abhängeset exkl.

Zubehöreffahrung

- Abhängeset 1,5m
Art. Nr. 135250
- Abhängeset 1,5m
Art. Nr. 135251
- Abhängeset 1,5m
Art. Nr. 135254
- Abhängeset 5m
Art. Nr. 1001950
- Abhängeset 5m
Art. Nr. 1001951
- Abhängeset 5m
Art. Nr. 1001952

Variante	Art. Nr.
Down: 4350/4750lm 3000/4000K CRI>80 Up: 120lm 3000/4000K CRI>80	
■ schwarz	1001886
Down: 4350/4750lm 3000/4000K CRI>80 Up: 120lm 3000/4000K CRI>80	
□ weiß	1001887
Down: 4350/4750lm 3000/4000K CRI>80 Up: 120lm 3000/4000K CRI>80	
■ grau	1001888

MEDO 90 CORONA
CL, TRIAC



A-A++ Spektrum A++-E

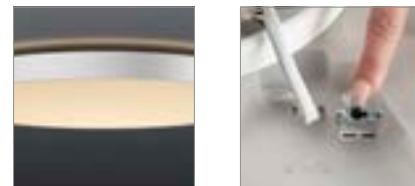

- Mit Corona Effekt
- Farbtemperatur (3000K/4000K) über Schalter einstellbar

Produktangaben

220-240V ~50/60Hz | 1050mA
Systemleistung: 78W
Material: Aluminium / Polycarbonat (PC)
Dimmbar: Triac C

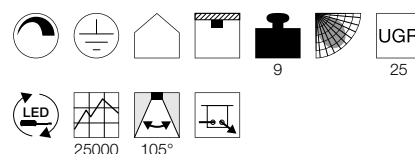

Maßzeichnung

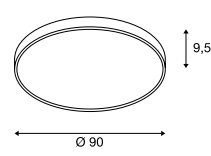

Hinweis

Abhängeset exkl.

Zubehöreffahrung

- Abhängeset 1,5m
Art. Nr. 135250
- Abhängeset 1,5m
Art. Nr. 135251
- Abhängeset 1,5m
Art. Nr. 135254
- Abhängeset 5m
Art. Nr. 1001950
- Abhängeset 5m
Art. Nr. 1001951
- Abhängeset 5m
Art. Nr. 1001952

Variante	Art. Nr.
Down: 9500/10100lm 3000/4000K CRI>80 Up: 125lm 3000/4000K CRI>80	
■ schwarz	1001878
Down: 9500/10100lm 3000/4000K CRI>80 Up: 125lm 3000/4000K CRI>80	
□ weiß	1001879
Down: 9500/10100lm 3000/4000K CRI>80 Up: 125lm 3000/4000K CRI>80	
■ grau	1001880

MEDO 30 CORONA
CW, DALI



A-A++ Spektrum A+-E

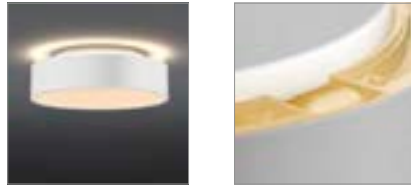

- Mit Corona Effekt
- Farbtemperatur (3000K/4000K) über Schalter einstellbar

Produktangaben

220-240V ~50/60Hz | 350mA
Systemleistung: 15W
Material: Aluminium / Polycarbonat (PC)
Dimmbar: Dali

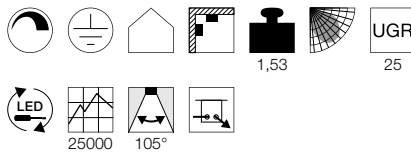

Maßzeichnung

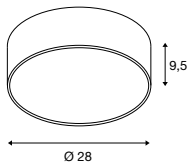

Hinweis

Abhängeset exkl.

Zubehörepfehlung

- Abhängeset 1,5m
Art. Nr. 135250
- Abhängeset 1,5m
Art. Nr. 135251
- Abhängeset 1,5m
Art. Nr. 135254
- Abhängeset 5m
Art. Nr. 1001950
- Abhängeset 5m
Art. Nr. 1001951
- Abhängeset 5m
Art. Nr. 1001952

Variante	Art. Nr.
Down: 1230/1280lm 3000/4000K CRI>80 Up: 20lm 3000/4000K CRI>80	
■ schwarz 1001889	
Down: 1230/1280lm 3000/4000K CRI>80 Up: 20lm 3000/4000K CRI>80	
□ weiß 1001893	
Down: 1230/1280lm 3000/4000K CRI>80 Up: 20lm 3000/4000K CRI>80	
■ grau 1001894	

MEDO 40 CORONA
CW, DALI



A-A++ Spektrum A+-E

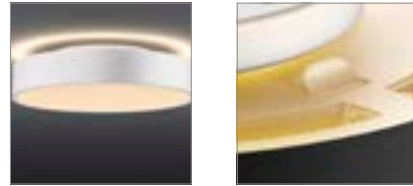

- Mit Corona Effekt
- Farbtemperatur (3000K/4000K) über Schalter einstellbar

Produktangaben

220-240V ~50/60Hz | 700mA
Systemleistung: 30W
Material: Aluminium / Polycarbonat (PC)
Dimmbar: Dali

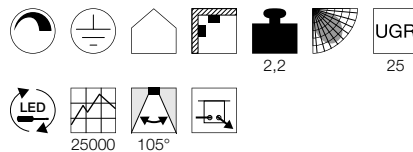

Maßzeichnung

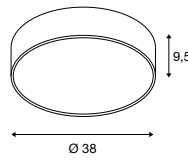

Hinweis

Abhängeset exkl.

Zubehörepfehlung

- Abhängeset 1,5m
Art. Nr. 135250
- Abhängeset 1,5m
Art. Nr. 135251
- Abhängeset 1,5m
Art. Nr. 135254
- Abhängeset 5m
Art. Nr. 1001950
- Abhängeset 5m
Art. Nr. 1001951
- Abhängeset 5m
Art. Nr. 1001952

Variante	Art. Nr.
Down: 2750/2900lm 3000/4000K CRI>80 Up: 50lm 3000/4000K CRI>80	
■ schwarz 1001895	
Down: 2750/2900lm 3000/4000K CRI>80 Up: 50lm 3000/4000K CRI>80	
□ weiß 1001896	
Down: 2750/2900lm 3000/4000K CRI>80 Up: 50lm 3000/4000K CRI>80	
■ grau 1001897	

MEDO 60 CORONA
CW, DALI



A-A++ Spektrum A+-E

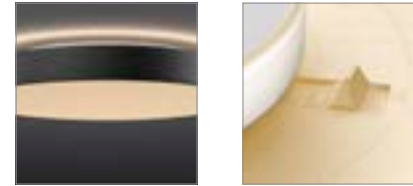

- Mit Corona Effekt
- Farbtemperatur (3000K/4000K) über Schalter einstellbar

Produktangaben

220-240V ~50/60Hz | 1000mA
Systemleistung: 40W
Material: Aluminium / Polycarbonat (PC)
Dimmbar: Dali

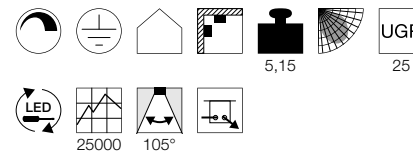

Maßzeichnung

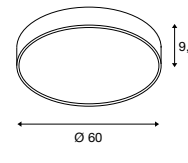

Hinweis

Abhängeset exkl.

Zubehörepfehlung

- Abhängeset 1,5m
Art. Nr. 135250
- Abhängeset 1,5m
Art. Nr. 135251
- Abhängeset 1,5m
Art. Nr. 135254
- Abhängeset 5m
Art. Nr. 1001950
- Abhängeset 5m
Art. Nr. 1001951
- Abhängeset 5m
Art. Nr. 1001952

Variante	Art. Nr.
Down: 4350/4750lm 3000/4000K CRI>80 Up: 120lm 3000/4000K CRI>80	
■ schwarz 1001898	
Down: 4350/4750lm 3000/4000K CRI>80 Up: 120lm 3000/4000K CRI>80	
□ weiß 1001900	
Down: 4350/4750lm 3000/4000K CRI>80 Up: 120lm 3000/4000K CRI>80	
■ grau 1001899	

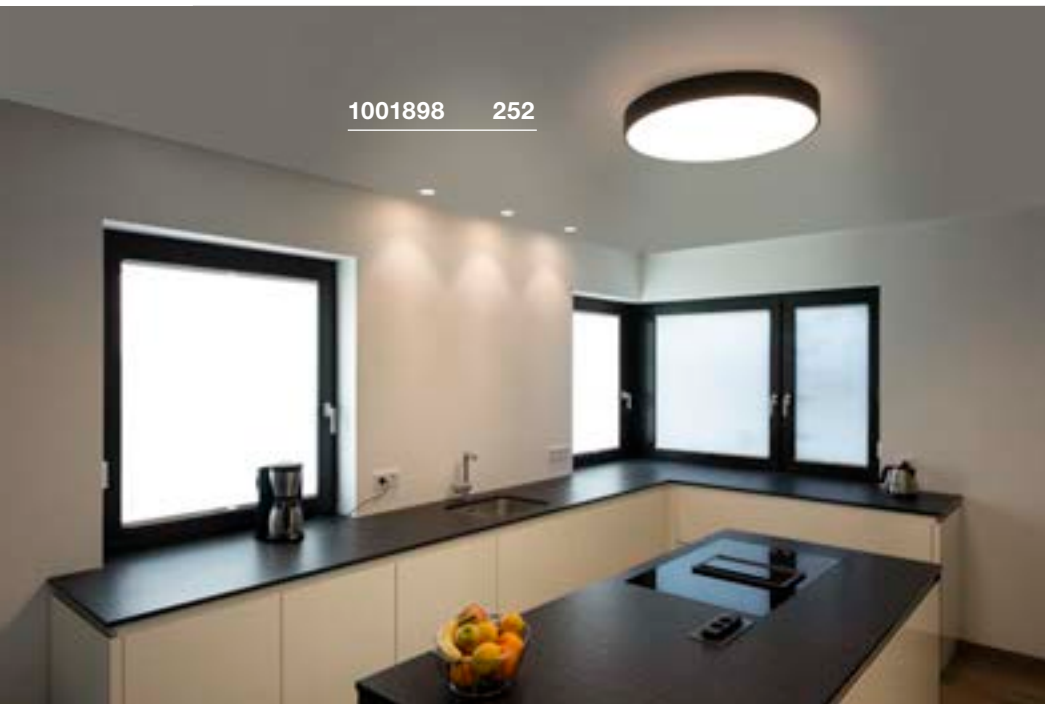

1001898 252

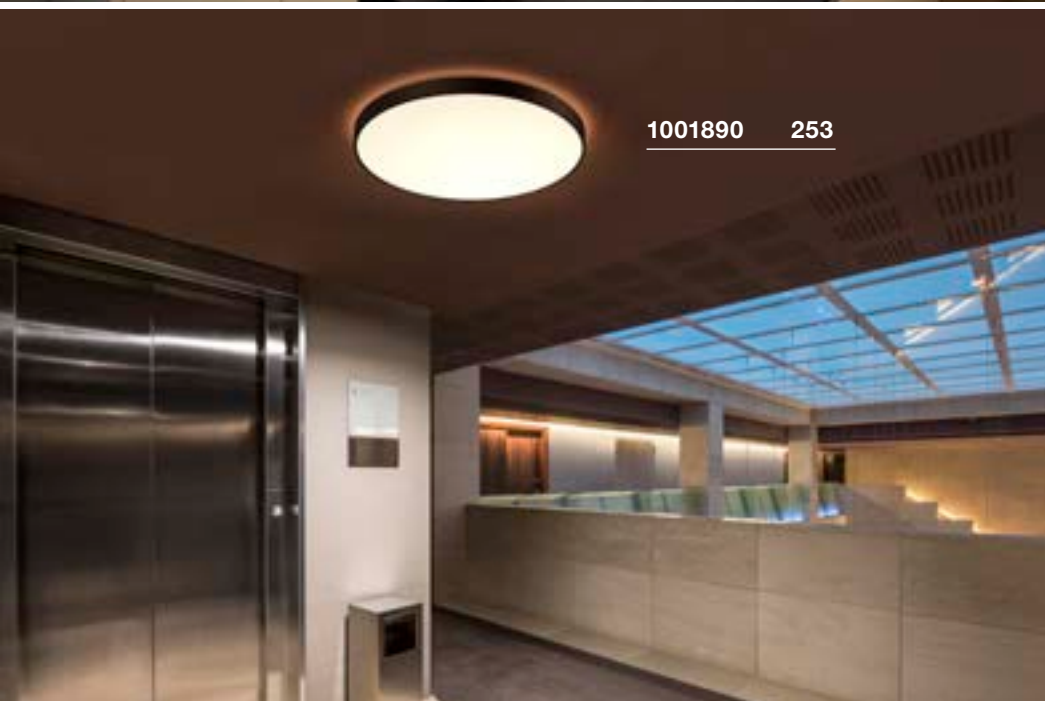

1001890 253

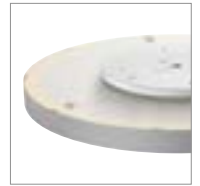

1001898 252

MEDO 90 CORONA
CL, DALIA-A++ Spektrum
A++-ELED
INSIDENEW
VARIANT

- Mit Corona Effekt
- Farbtemperatur (3000K/4000K) über Schalter einstellbar

Produktangaben

220-240V ~50/60Hz | 1000mA
Systemleistung: 78W
Material: Aluminium / Polycarbonat (PC)
Dimmbar: Dali

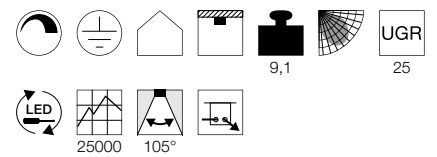

Maßzeichnung

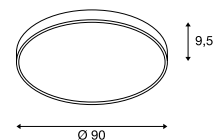

Hinweis

Abhängeset exkl.

Zubehörempfehlung

■ Abhängeset 1,5m	Art. Nr. 135250	
□ Abhängeset 1,5m	Art. Nr. 135251	
■ Abhängeset 1,5m	Art. Nr. 135254	
□ Abhängeset 5m	Art. Nr. 1001950	
■ Abhängeset 5m	Art. Nr. 1001951	
■ Abhängeset 5m	Art. Nr. 1001952	

Variante	Art. Nr.
Down: 9500/10100lm 3000/4000K CRI>80 Up: 125lm 3000/4000K CRI>80	■ schwarz 1001890
Down: 9500/10100lm 3000/4000K CRI>80 Up: 125lm 3000/4000K CRI>80	□ weiß 1001891
Down: 9500/10100lm 3000/4000K CRI>80 Up: 125lm 3000/4000K CRI>80	■ grau 1001892

MEDO 60
CL, square



A-A++ Spektrum
A++-E



1000725 254



Produktangaben

100-240V ~50/60Hz | 1000mA
Systemleistung: 39W
Material: Aluminium / Acryl
Dimmbar: 1-10V

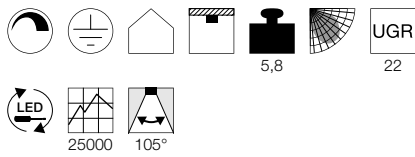

Maßzeichnung

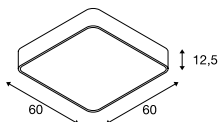

Hinweis

Abhängeset exkl.

Zubehöreffehlung

- Abhängeset 1,5m
Art. Nr. 135250
- Abhängeset 1,5m
Art. Nr. 135251
- Abhängeset 1,5m
Art. Nr. 135254
- 1-10V Dimming
Art. Nr. 470505
- Abhängeset 5m
Art. Nr. 1001950
- Abhängeset 5m
Art. Nr. 1001951
- Abhängeset 5m
Art. Nr. 1001952

Variante	Art. Nr.
3300lm 3000K CRI>80 <input checked="" type="checkbox"/> schwarz	1000725
3300lm 3000K CRI>80 <input type="checkbox"/> weiß	1000726
3300lm 3000K CRI>80 <input checked="" type="checkbox"/> grau	1000727



1000727 255

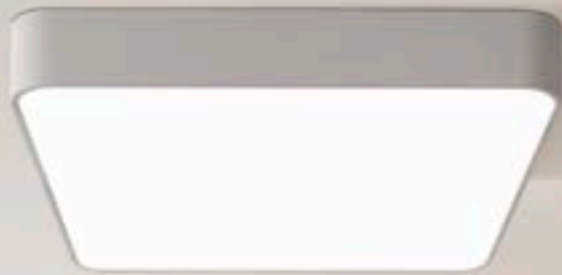

MEDO 60 CL, Square, DALI



A-A++ Spektrum
A++-E

**LED
INSIDE**

**NEW
VARIANT**



Produktangaben

100-277V ~50/60Hz | 1000mA
Systemleistung: 39W
Material: Aluminium / Acryl
Dimmbar: Dali

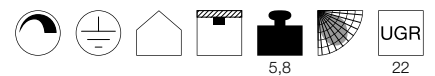

Maßzeichnung

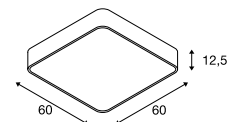

Zubehöreffehlung

- Abhängeset 1,5m Art. Nr. **135250**
- Abhängeset 1,5m Art. Nr. **135251**
- Abhängeset 1,5m Art. Nr. **135254**
- Abhängeset 5m Art. Nr. **1001950**
- Abhängeset 5m Art. Nr. **1001951**
- Abhängeset 5m Art. Nr. **1001952**

Variante	Art. Nr.
3300lm 3000K CRI>80 <input type="checkbox"/> weiß	1002882

PANEL 60
CL, round, TRIAC

A-A++ Spektrum
A+-E

LED
INSIDE

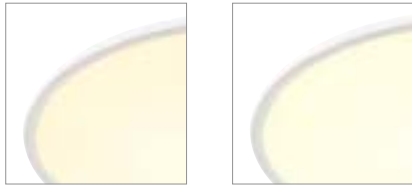

- Aufbau oder Teileinbau des Panels möglich

Produktangaben

220-240V ~50/60Hz | 1000mA
Systemleistung: 42W
Material: Aluminium / Polymethylacrylat (PMMA)
Einbaumaße: Einbau-Ø: 20 cm T: 7 cm
Dimmbar: Triac C

5
 UGR 22

30000
110°
40

Maßzeichnung

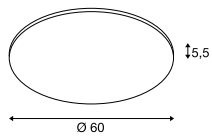

Variante	Art. Nr.
3150lm 3000K CRI>80 □ weiß	1000783
3350lm 4000K CRI>80 □ weiß	1000784
3150lm 3000K CRI>80 ■ grau	1000785
3350lm 4000K CRI>80 ■ grau	1000786

1000783 256

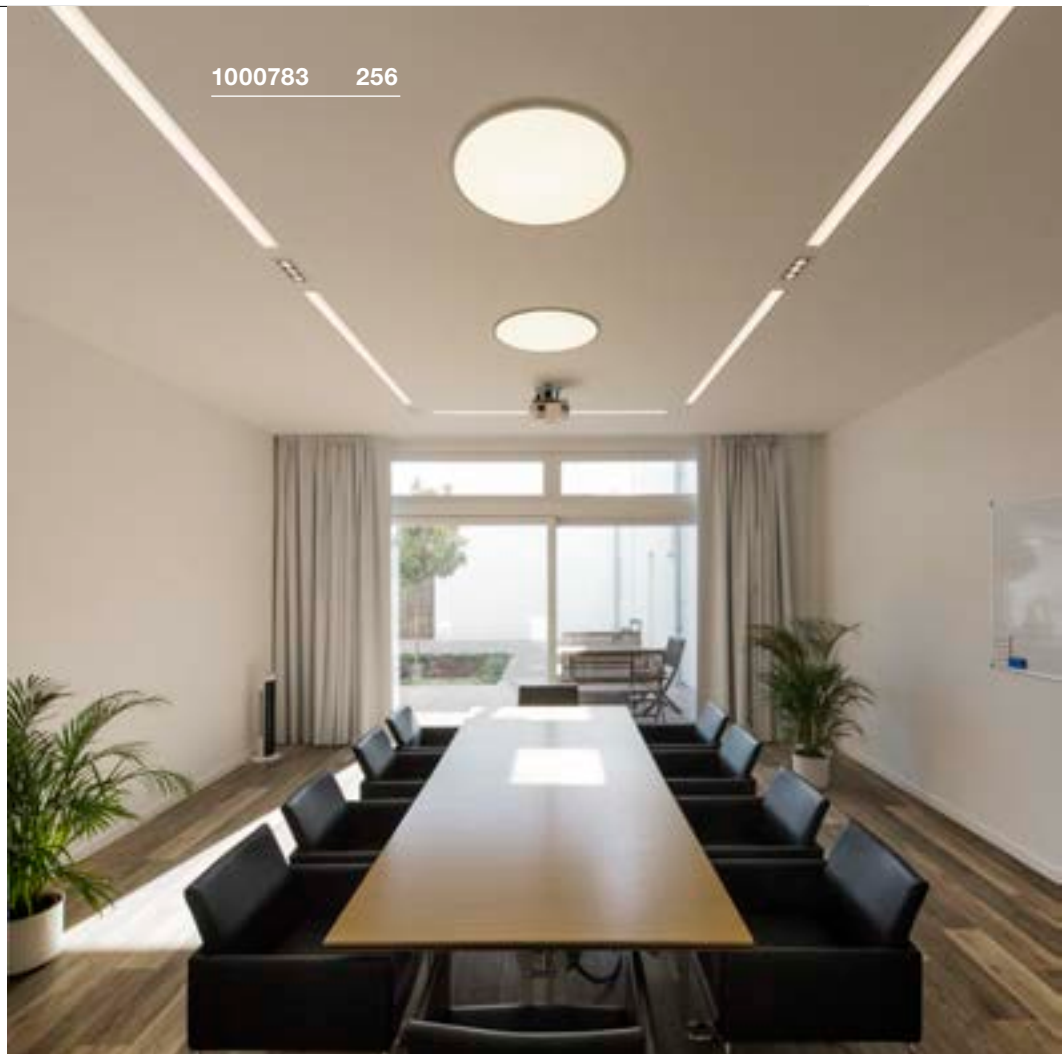

1000785 256

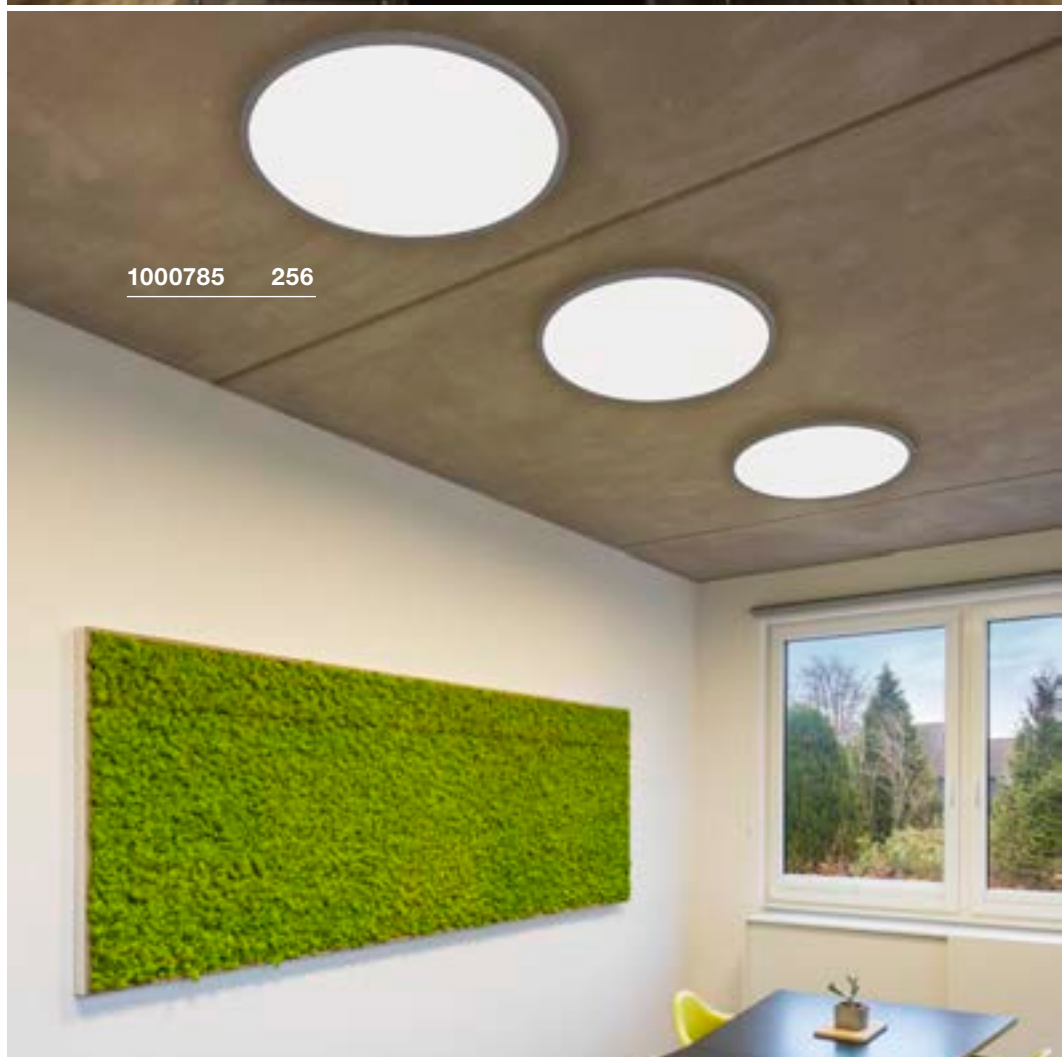

PANEL 60
CL, round, DALI

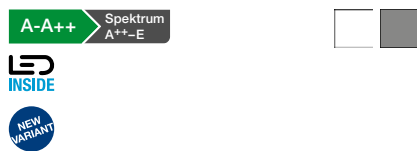

- Aufbau oder Teileinbau des Panels möglich

Produktangaben

100-277V ~50/60Hz | 1000mA
Systemleistung: 42W
Material: Aluminium / Polymethylacrylat (PMMA)
Einbaumaße: Einbau-Ø: 20 cm T: 7 cm
Dimmbar: Dali

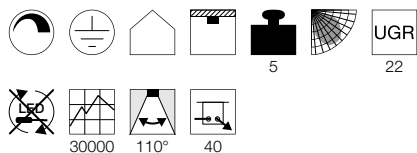

Maßzeichnung

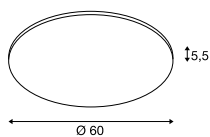

PANEL
CL, 1200x300mm, TRIAC

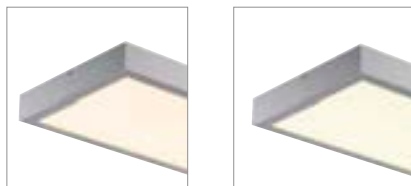
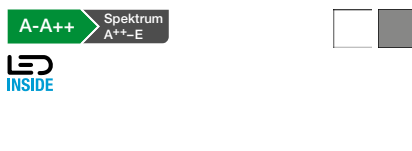

- UGR<19
- Bildschirmarbeitsplatzgerecht gemäß EN 12464-1

Produktangaben

220-240V ~50/60Hz | 1000mA
Systemleistung: 45W
Material: Aluminium / Polymethylacrylat (PMMA)
Dimmbar: Triac C

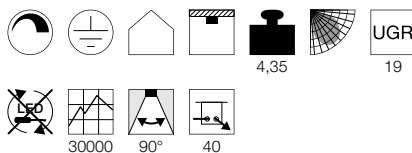

Maßzeichnung

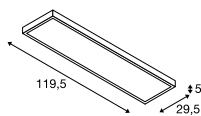

PANEL
CL, 1200x300mm, DALI

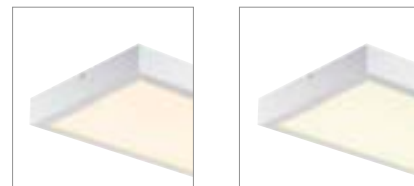

- UGR<19
- Bildschirmarbeitsplatzgerecht gemäß EN 12464-1

Produktangaben

100-277V ~50/60Hz | 1000mA
Systemleistung: 45W
Material: Aluminium / Polymethylacrylat (PMMA)
Dimmbar: Dali

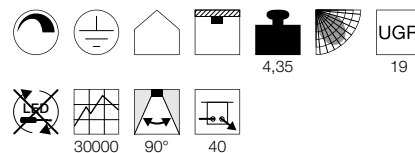

Maßzeichnung

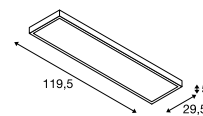

Variante	Art. Nr.
3150lm 3000K CRI>80 □ weiß	1003040
3350lm 4000K CRI>80 □ weiß	1003041
3150lm 3000K CRI>80 ■ grau	1003042
3350lm 4000K CRI>80 ■ grau	1003043

Variante	Art. Nr.
3100lm 3000K CRI>80 □ weiß	1001505
3400lm 4000K CRI>80 □ weiß	1001506
3100lm 3000K CRI>80 ■ grau	1001508
3400lm 4000K CRI>80 ■ grau	1001509

Variante	Art. Nr.
3100lm 3000K CRI>80 □ weiß	1003052
3400lm 4000K CRI>80 □ weiß	1003053
3100lm 3000K CRI>80 ■ grau	1003054
3400lm 4000K CRI>80 ■ grau	1003055

RASTO 120/150
CL, double

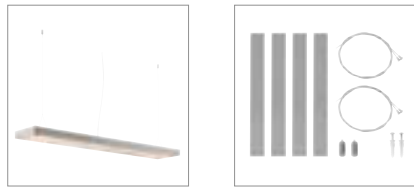

Produktangaben

220-240V ~50/60Hz | 775mA
Material: Aluminium / Stahl

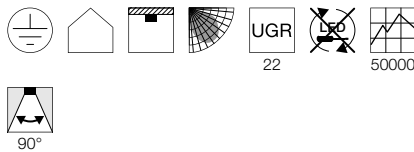

Maßzeichnung

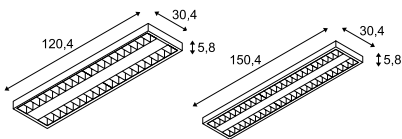

Hinweis

Optionales Abhängeset als Zubehör erhältlich.

Zubehörempfehlung

■ Abhängeset 1,5m
Art. Nr. **158969**

Variante	Art. Nr.
3900lm 3000K CRI>80 36W L: 120,4 cm 4,7 kg	158941
6400lm 3000K CRI>80 60W L: 150,4 cm 5,5 kg	158951

RASTO 125/155
CL, double

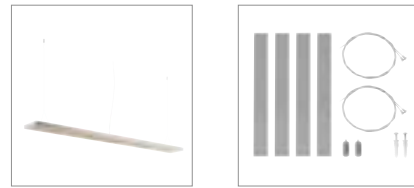
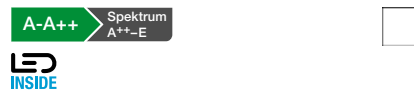

- UGR<19
- Bildschirmarbeitsplatzgerecht gemäß EN 12464-1

Produktangaben

220-240V ~50/60Hz | 300mA
Material: Aluminium / Stahl

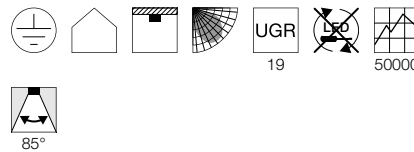

Maßzeichnung

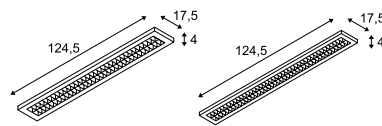

Hinweis

Optionales Abhängeset als Zubehör erhältlich.

Zubehörempfehlung

■ Abhängeset 1,5m
Art. Nr. **158969**

Variante	Art. Nr.
4100lm 3000K CRI>80 36W L: 124,5 cm 2,8 kg	158961
4900lm 3000K CRI>80 44W L: 154,5 cm 3,4 kg	158971

158951 258



158961 258





1000689 259

Q-LINE®
CL, 1m, BAP



A-A++ Spektrum A++-E



- Premium LED mit CRI>90

Produktangaben

220-240V ~50/60Hz | 900mA
Systemleistung: 45W
Material: Aluminium / Kunststoff
Dimmbar: Triac L

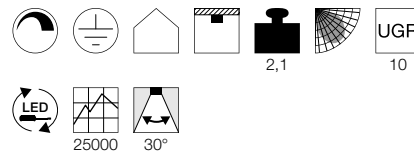

Maßzeichnung

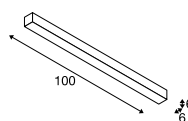

1000692 259

Q-LINE®
CL, 2m, BAP



A-A++ Spektrum A++-E



- Premium LED mit CRI>90

Produktangaben

220-240V ~50/60Hz | 900mA
Systemleistung: 85W
Material: Aluminium / Kunststoff
Dimmbar: Triac L

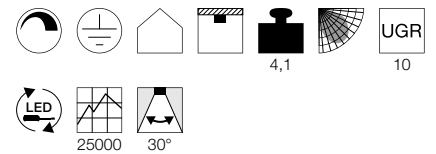

Maßzeichnung

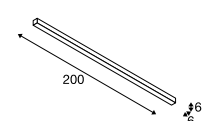

Variante	Art. Nr.
2100lm 3000K CRI>90 □ weiß	1000685
2100lm 3000K CRI>90 ■ schwarz	1000686
2100lm 3000K CRI>90 ■ grau	1000687
2300lm 4000K CRI>90 □ weiß	1000688
2300lm 4000K CRI>90 ■ schwarz	1000689
2300lm 4000K CRI>90 ■ grau	1000690

Variante	Art. Nr.
4200lm 3000K CRI>90 □ weiß	1000691
4200lm 3000K CRI>90 ■ schwarz	1000692
4200lm 3000K CRI>90 ■ grau	1000693
4600lm 4000K CRI>90 □ weiß	1000694
4600lm 4000K CRI>90 ■ schwarz	1000695
4600lm 4000K CRI>90 ■ grau	1000696

ROTOBALL 25
CL, E27



A-A++ Spektrum A++-E



Produktangaben

230V ~50Hz
Material: Stahl / Polyethylen (PE)

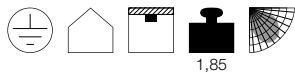

Maßzeichnung

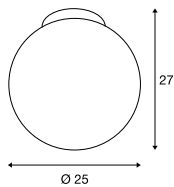

Leuchtmittlempfehlung

LED E27 14,5W 200°
2700K 1521lm EEK=A+
15kWh/1000h
Art. Nr. 560422



LED E27 9W 240°
2700-6500K 806lm EEK=A+
9kWh/1000h
Art. Nr. 1001916



Leuchtmittelangaben

max. 24W
Ø: 9,5 cm max.

Variante	Art. Nr.
E27 □ weiß	1002051

ROTOBALL 40
CL, E27



A-A++ Spektrum A++-E



Produktangaben

230V ~50Hz
Material: Stahl / Polyethylen (PE)

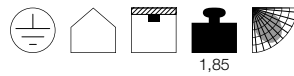

Maßzeichnung

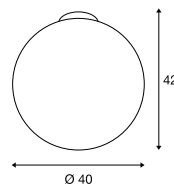

Leuchtmittlempfehlung

LED E27 14,5W 200°
2700K 1521lm EEK=A+
15kWh/1000h
Art. Nr. 560422



LED E27 9W 240°
2700-6500K 806lm EEK=A+
9kWh/1000h
Art. Nr. 1001916



Leuchtmittelangaben

max. 24W
Ø: 9,5 cm max.

Variante	Art. Nr.
E27 □ weiß	1002052

MALANG
CL, E27

E-A++ Spektrum A++-E

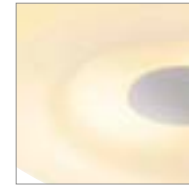
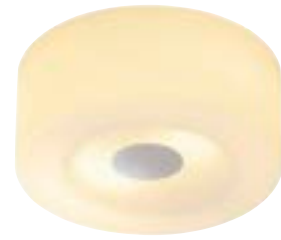

Produktangaben

230V ~50Hz
Material: Stahl / Glas

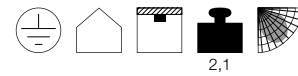

Maßzeichnung

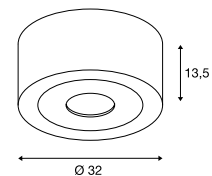

Leuchtmittlempfehlung

LED E27 9,1W 240°
2700K 760lm EEK=A+
10kWh/1000h
Art. Nr. 560402



LED E27 9,5W 240°
2200-6700K 806lm EEK=A+
10kWh/1000h
Art. Nr. 1001917



Leuchtmittelangaben

2x max. 60W
Ø: 5,5 cm max. L: 13,5 cm max.

Variante	Art. Nr.
E27 ■ weiß / chrom	146942

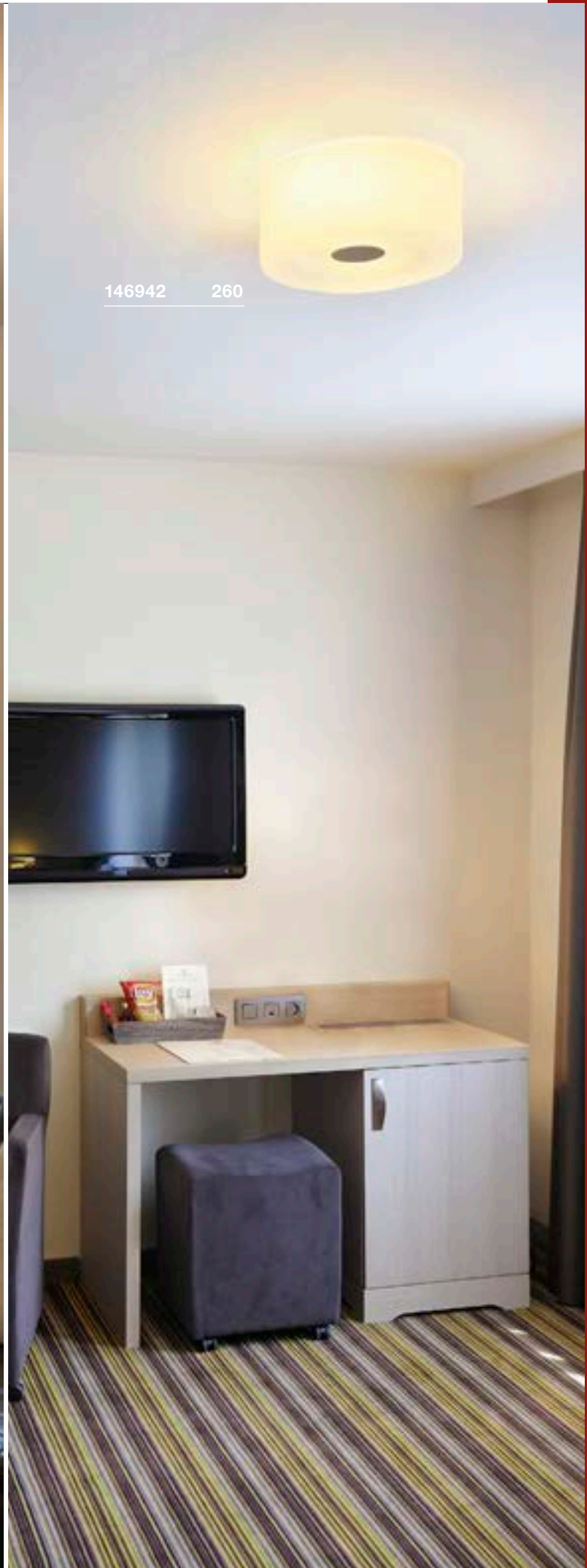



DESIGNED BY
David Morgan



OCCULDAS 13
DL, indirect, TRIAC



A-A++ Spektrum
A++-E



- Blendfreies indirektes Licht

Produktangaben

220-240V ~50/60Hz | 350mA
Systemleistung: 15W
Material: Aluminium
Dimmbar: Triac C

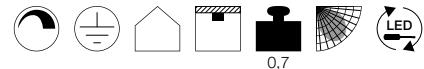

0,7

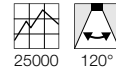

25000 120°

Maßzeichnung

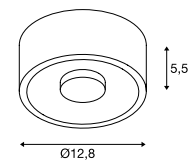

"Excellent light quality from innovative, distinctive and attractive luminaire designs."

Variante	Art. Nr.
810lm 3000K CRI>80 □ weiß	117351

OCCULDAS 23
DL, indirect, TRIAC



A-A++ Spektrum A++-E

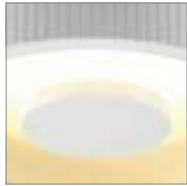

- Blendfreies indirektes Licht

Produktangaben

200-240V ~50/60Hz | 700mA
Systemleistung: 26W
Material: Aluminium / Stahl
Dimmbar: Triac C, Triac L, Uni

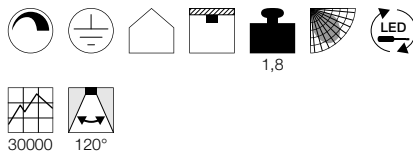

30000 120°

Maßzeichnung

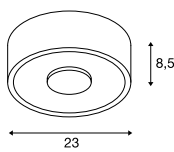

OCCULDAS 13
DL, TRIAC



A-A++ Spektrum A++-E



Produktangaben

220-240V ~50/60Hz | 700mA
Systemleistung: 16W
Material: Aluminium
Dimmbar: Triac C

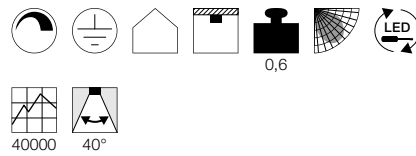

40000 40°

Maßzeichnung

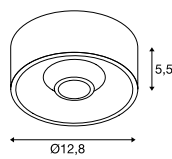

OCCULDAS 13 MOVE
DL, TRIAC



A-A++ Spektrum A++-E



- Einstellbarer Spot

Produktangaben

220-240V ~50/60Hz | 350mA
Systemleistung: 7,8W
Material: Aluminium / Stahl
Dimmbar: Triac C

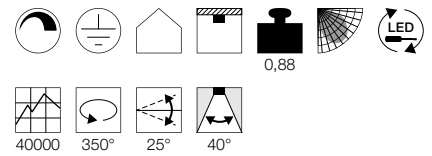

40000 350° 25° 40°

Maßzeichnung

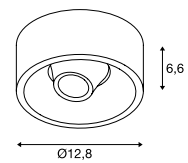

Variante	Art. Nr.
1500lm 3000K CRI>80 □ weiß	117321

Variante	Art. Nr.
1200lm 3000K CRI>80 □ weiß	117381

Variante	Art. Nr.
700lm 3000K CRI>80 □ weiß	117361

ASTINA
CL



NAGY 75
CL, QPAR51

A-A++ Spektrum A++-E



A-A++ Spektrum A++-E



- Hochwertiges, satiniertes Glas

- Individuell gestaltbar mit Farben, Stickern und mehr

Produktangaben

220-240V ~50/60Hz
Material: Aluminium

Produktangaben

220-240V ~50/60Hz
Material: Gips
Produktmaße: Ø: 7,5 cm H: 14 cm

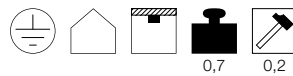
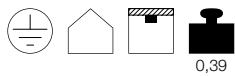

Maßzeichnung

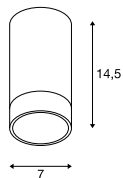

Leuchtmittlempfehlung

LED GU10 7,2W 36°
4000K 540lm EEK=A+
8kWh/1000h
Art. Nr. 1001565



Leuchtmittlempfehlung

LED GU10 7,2W 36°
4000K 540lm EEK=A+
8kWh/1000h
Art. Nr. 1001565



LED GU10 5,5W 38°
2700K 400lm EEK=A+
6kWh/1000h
Art. Nr. 1001030



LED GU10 5,5W 38°
2700K 400lm EEK=A+
6kWh/1000h
Art. Nr. 1001030



Leuchtmittelangaben

max. 10W QPAR51

Leuchtmittelangaben

max. 10W QPAR51

Variante	Art. Nr.
GU10 QPAR51 □ matt weiß	1002934
GU10 QPAR51 ■ matt grau	1002935
GU10 QPAR51 ■ matt schwarz	1002936

Variante	Art. Nr.
GU10 QPAR51 □ matt weiß	1002965

1002965 264



1002935 264

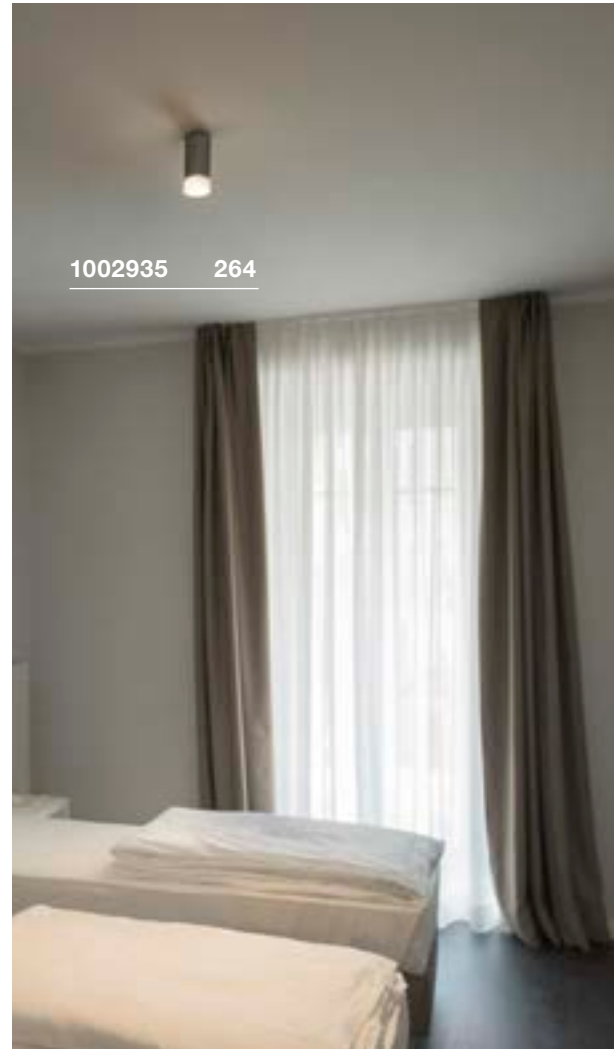

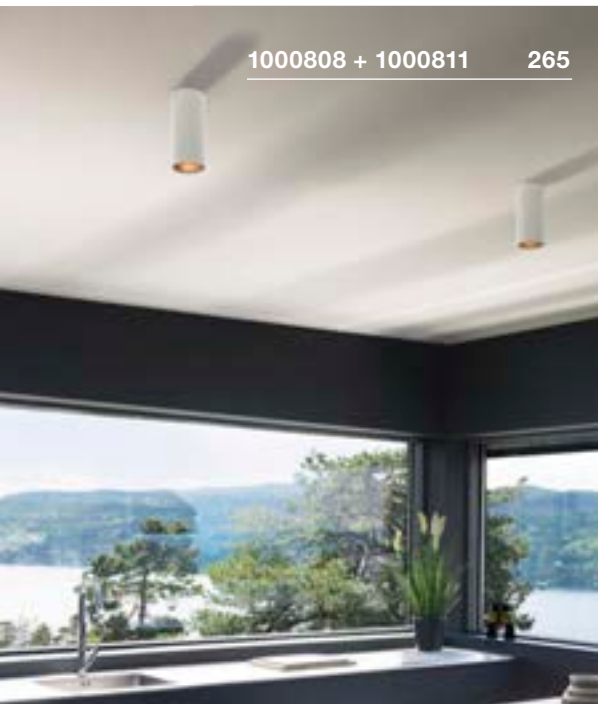

1000808 + 1000811 265



151810 265

ENOLA B
CL, QPAR51



E-A++ Spektrum A++-E



ANELA
CL



A-A++ Spektrum A++-E



- Premium LED mit CRI>90
- Blendreduziert
- Farbige Reflek oren als Zubehör erhältlich

Produktangaben

220-240V ~50/60Hz
Material: Aluminium / Stahl

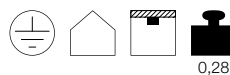

Maßzeichnung

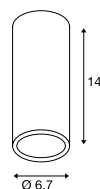

Zubehörempfehlung

■ Zierring
Art. Nr. 151840



Leuchtmittlempfehlung

GU10 5,5W 36°
2800K 420lm EEK=A+
6kWh/1000h
Art. Nr. 1001217



LED GU10 7,2W 36°
4000K 540lm EEK=A+
8kWh/1000h
Art. Nr. 1001565



Leuchtmittelangaben

max. 35W QPAR51
L: 8,5 cm max.

Variante	Art. Nr.
GU10 QPAR51	
■ schwarz	151810
GU10 QPAR51	
□ weiß	151811
GU10 QPAR51	
■ gold	151813
GU10 QPAR51	
■ grau / schwarz	151814

Produktangaben

220-240V ~50/60Hz | 500mA
Systemleistung: 11W
Material: Aluminium
Dimmbar: Triac C

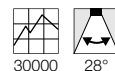
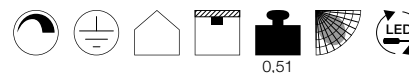

Maßzeichnung

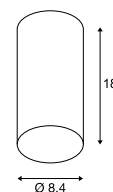

Hinweis

Lichtstrom mit Reflek or 1000809 = 500lm
Lichtstrom mit Reflek or 1000810 = 620lm
Lichtstrom mit Reflek or 1000811 = 200lm
Lichtstrom mit Reflek or 1000812 = 600lm

Zubehörempfehlung

■ Reflek or 28°
Art. Nr. 1000809
■ Reflek or 28°
Art. Nr. 1000810
■ Reflek or 28°
Art. Nr. 1000811
□ Reflek or 28°
Art. Nr. 1000812



Variante	Art. Nr.
200-620lm 3000K CRI>90	
■ Reflek or 28°	1000807
200-620lm 3000K CRI>90	
□ Reflek or 28°	1000808



Reflek or 28° – wechseln Sie bei dieser Leuchte den Reflek or aus und erhalten durch die verschiedenen Farben (gold, grau, schwarz und weiß) eine andere Lichtwirkung.

ROX
CL, QPAR111



E-A++ Spektrum A++-E



- Hochwertig gebürstete Oberfläche

Produktangaben

230V ~50Hz
Material: Aluminium / Glas

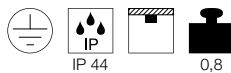

Maßzeichnung

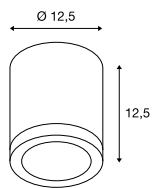

Leuchtmittlempfehlung

GU10 7,9W 25°
2700K 730lm EEK=A+
8kWh/1000h
Art. Nr. 560702



LED GU10 9W 25°
2700-6500K 765lm EEK=A+
9kWh/1000h
Art. Nr. 1001920



Leuchtmittelangaben

max. 50W QPAR111

Variante	Art. Nr.
GU10 QPAR111	
gebürstet aluminium	1000332

ENOLA C
CL



A-A++ Spektrum A++-E



- Premium LED mit CRI>90
- Dim to Warm
- Beim Dimmen ändert sich die Lichtfarbe

Produktangaben

220-240V ~50/60Hz | 350mA
Systemleistung: 15W
Material: Aluminium / Glas
Dimmbar: Triac C

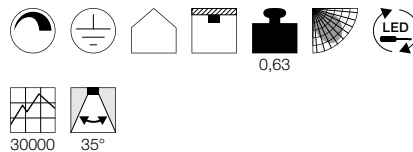

Maßzeichnung

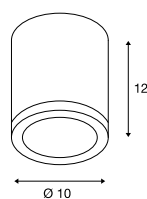

Leuchtmittlempfehlung

GU10 7,9W 25°
2700K 730lm EEK=A+
8kWh/1000h
Art. Nr. 560702



LED GU10 9W 25°
2700-6500K 765lm EEK=A+
9kWh/1000h
Art. Nr. 1001920



Leuchtmittelangaben

max. 50W QPAR111

Variante	Art. Nr.
900lm 2000-3000K CRI>90	
weiß	1000631

ENOLA C
CL



A-A++ Spektrum A++-E



- Premium LED mit CRI>90
- Dim to Warm
- Beim Dimmen ändert sich die Lichtfarbe

Produktangaben

100-240V ~50/60Hz | 500mA
Systemleistung: 12W
Material: Aluminium / Glas

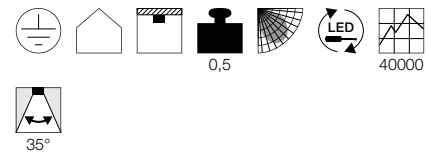

Maßzeichnung

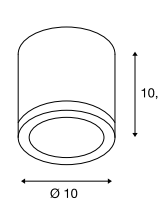

Leuchtmittlempfehlung

GU10 7,9W 25°
2700K 730lm EEK=A+
8kWh/1000h
Art. Nr. 560702



LED GU10 9W 25°
2700-6500K 765lm EEK=A+
9kWh/1000h
Art. Nr. 1001920



Leuchtmittelangaben

max. 50W QPAR111

Variante	Art. Nr.
850lm 3000K CRI>80	
weiß	152101



151514 267



151531 267

ALTRA DICE
CL, QPAR51



E-A++ Spektrum A++-E



Produktangaben

220-240V ~50/60Hz
Material: Aluminium / Stahl

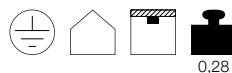

Maßzeichnung

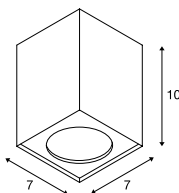

Leuchtmittlempfehlung

LED GU10 5,5W 38°
2700K 400lm EEK=A+
6kWh/1000h
Art. Nr. 1001030



LED GU10 5,5W 36°
2800K 420lm EEK=A+
6kWh/1000h
Art. Nr. 1001217



Leuchtmittelangaben

max. 35W QPAR51

Variante	Art. Nr.
GU10 QPAR51	
□ weiß	151511
GU10 QPAR51	
■ grau / schwarz	151514
GU10 QPAR51	
■ schwarz	1002216

ALTRA DICE
CW, double, QPAR51



E-A++ Spektrum A++-E



Produktangaben

220-240V ~50/60Hz
Material: Aluminium / Stahl

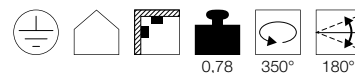

Maßzeichnung

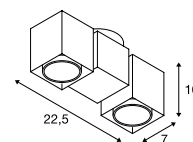

Leuchtmittlempfehlung

LED GU10 4,3W 40°
3000K 375lm EEK=A++
5kWh/1000h
Art. Nr. 560143



LED GU10 5,5W 36°
2800K 420lm EEK=A+
6kWh/1000h
Art. Nr. 1001217



Leuchtmittelangaben

2x max. 50W QPAR51

Variante	Art. Nr.
GU10 QPAR51	
□ weiß	151531
GU10 QPAR51	
■ grau / schwarz	151534
GU10 QPAR51	
■ schwarz	1002215

TEC KALU
CL, double, TRIAC



A-A++ Spektrum A++-E

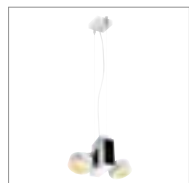

- Durch das optionale Abhängeset zur Pendelleuchte umfunktionierbar
- Spots 360° drehbar und 120° schwenkbar
- Gesamte Leuchte 360° drehbar

Produktangaben

220-240V ~50/60Hz | 700mA
Systemleistung: 31W
Material: Aluminium / Polycarbonat (PC)
Dimmbar: Triac C

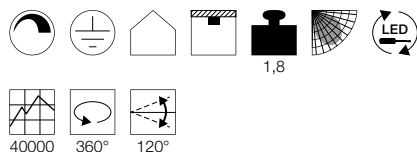

Maßzeichnung

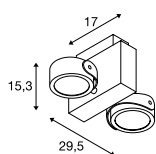

Zubehörempfehlung

- Abhängeset 1,5m
Art. Nr. **1001435**
- Abhängeset 1,5m
Art. Nr. **1001436**

Variante	Art. Nr.
1900lm 3000K CRI>80 24° ■ schwarz	1001431
1900lm 3000K CRI>80 24° ■ weiß / schwarz	1001432
1900lm 3000K CRI>80 60° ■ schwarz	1001423
1900lm 3000K CRI>80 60° ■ weiß / schwarz	1001424

TEC KALU
CL, quad, TRIAC



A-A++ Spektrum A++-E



- Durch das optionale Abhängeset zur Pendelleuchte umfunktionierbar
- Spots 360° drehbar und 120° schwenkbar
- Gesamte Leuchte 360° drehbar

Produktangaben

220-240V ~50/60Hz | 700mA
Systemleistung: 60W
Material: Aluminium / Polycarbonat (PC)
Dimmbar: Triac C

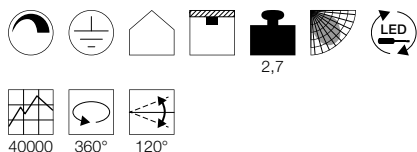

Maßzeichnung

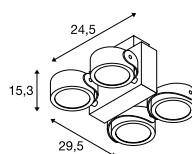

Zubehörempfehlung

- Abhängeset 1,5m
Art. Nr. **1001435**
- Abhängeset 1,5m
Art. Nr. **1001436**

Variante	Art. Nr.
3800lm 3000K CRI>80 24° ■ schwarz	1001433
3800lm 3000K CRI>80 24° ■ weiß / schwarz	1001434
3800lm 3000K CRI>80 60° ■ schwarz	1001425
3800lm 3000K CRI>80 60° ■ weiß / schwarz	1001426

1001426 268



1001434 + 1001436 268





1002011 269



1002004 269

TRILEDO
CL, single, round, QPAR51

E-A++ Spektrum A++-E



Produktangaben

220-240V ~50/60Hz
Material: Aluminium

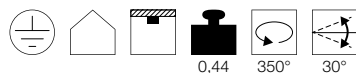

Maßzeichnung

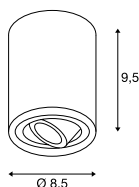

Leuchtmittlempfehlung

LED GU10 7,2W 36°
2700K 570lm EEK=A+
8kWh/1000h
Art. Nr. 560552



LED GU10 5,5W 38°
2700K 400lm EEK=A+
6kWh/1000h
Art. Nr. 1001030



Leuchtmittelangaben

max. 10W LED GU10 51mm
Ø: 5 cm max. L: 5,5 cm max.

Variante	Art. Nr.
GU10 LED GU10 51mm □ weiß	1002011
GU10 LED GU10 51mm ■ gebürstet aluminium	1002012
GU10 LED GU10 51mm ■ schwarz	1002010

TRILEDO
CL, single, square, QPAR51

E-A++ Spektrum A++-E



Produktangaben

220-240V ~50/60Hz
Material: Aluminium

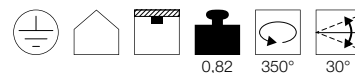

Maßzeichnung

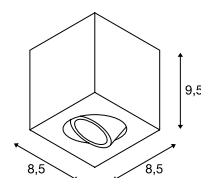

Leuchtmittlempfehlung

LED GU10 7,2W 36°
4000K 540lm EEK=A+
8kWh/1000h
Art. Nr. 1001566



LED GU10 5,5W 36°
2800K 420lm EEK=A+
6kWh/1000h
Art. Nr. 1001217



Leuchtmittelangaben

max. 10W LED GU10 51mm
Ø: 5 cm max. L: 5,5 cm max.

Variante	Art. Nr.
GU10 LED GU10 51mm □ weiß	1002015
GU10 LED GU10 51mm ■ gebürstet aluminium	1002004
GU10 LED GU10 51mm ■ schwarz	1002013

TRILEDO

CL, double, square, QPAR51

E-A++ Spektrum
A++-E



Produktangaben

220-240V ~50/60Hz
Material: Aluminium

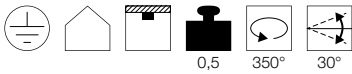

Maßzeichnung

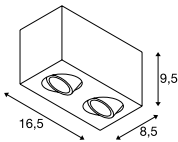

Leuchtmittlempfehlung

LED GU10 7,2W 36°
4000K 540lm EEK=A+
8kWh/1000h
Art. Nr. 1001566



LED GU10 5,5W 36°
2800K 420lm EEK=A+
6kWh/1000h
Art. Nr. 1001217



Leuchtmittelangaben

2x max. 10W LED GU10 51mm
Ø: 5 cm max. L: 5,5 cm max.

Variante	Art. Nr.
GU10 LED GU10 51mm □ weiß	1002006
GU10 LED GU10 51mm ■ schwarz	1002005

113936 271

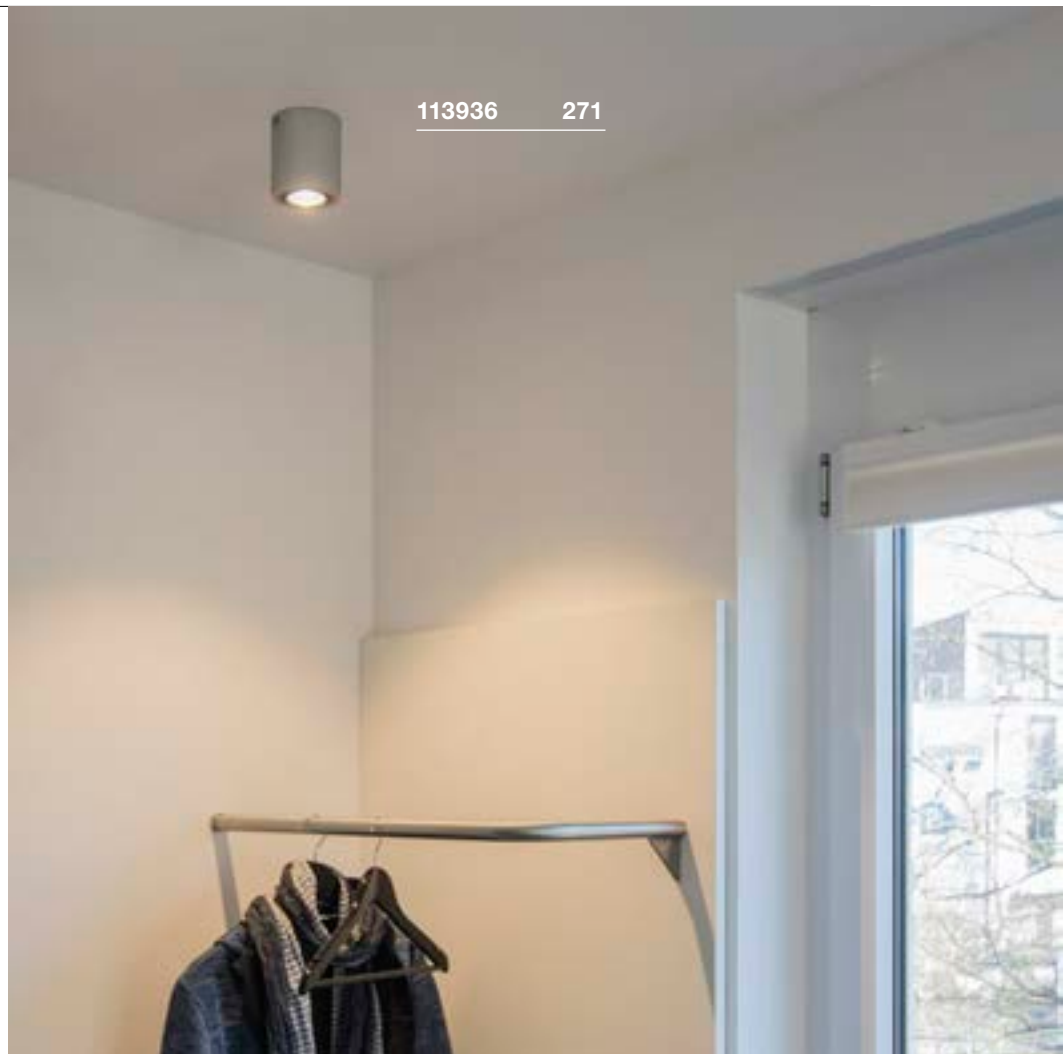

1002008 271

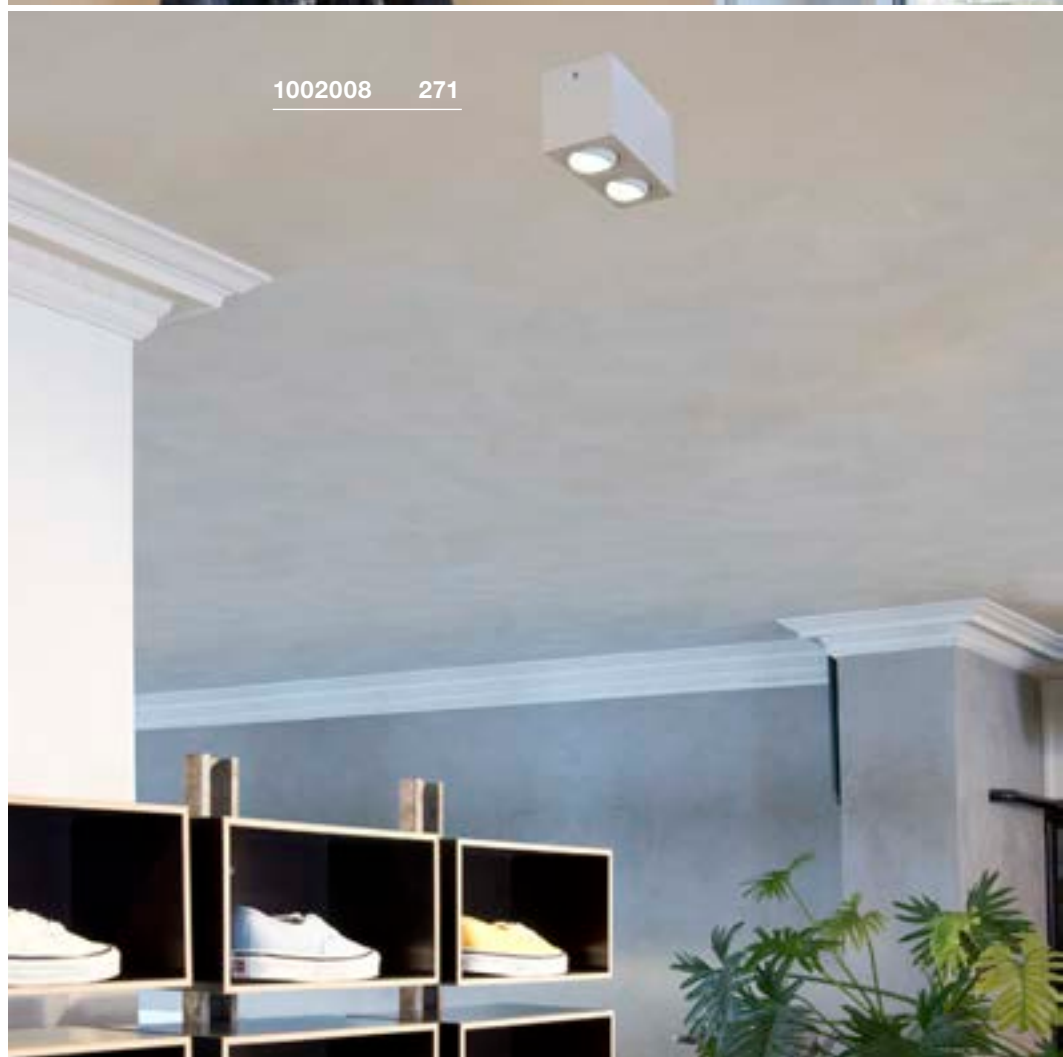

TRILEDO
CL, single, round



Produktangaben

100-240V ~50/60Hz | 350mA
Systemleistung: 8,1W
Material: Aluminium

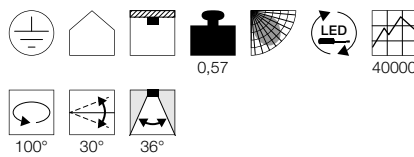

Maßzeichnung

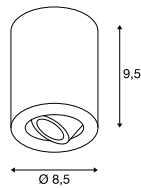

TRILEDO
CL, single, square

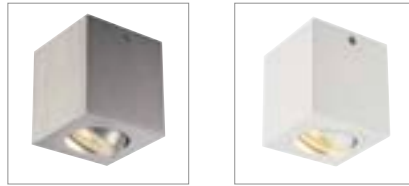
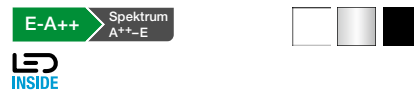

Produktangaben

100-240V ~50/60Hz | 350mA
Systemleistung: 8,1W
Material: Aluminium

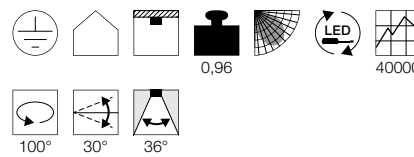

Maßzeichnung

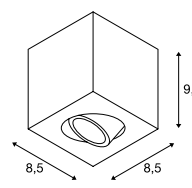

TRILEDO
CL, double, square



Produktangaben

220-240V ~50/60Hz | 350mA
Systemleistung: 14W
Material: Aluminium

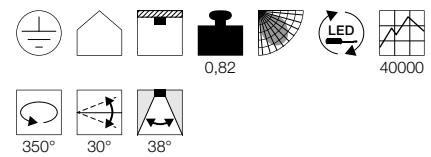

Maßzeichnung

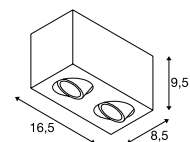

Variante	Art. Nr.
670lm 3000K CRI>80 □ weiß	113931
670lm 3000K CRI>80 ▒ matt aluminium	113936
670lm 3000K CRI>80 ■ matt schwarz	113930

Variante	Art. Nr.
670lm 3000K CRI>80 □ weiß	113941
670lm 3000K CRI>80 ▒ matt aluminium	113946
670lm 3000K CRI>80 ■ matt schwarz	113940

Variante	Art. Nr.
1100lm 3000K CRI>80 □ weiß	1002008
1100lm 3000K CRI>80 ■ schwarz	1002003

PLASTRA
CL, QPAR51



E-A++ Spektrum A++-E



- Individuell gestaltbar mit Farben, Stickers & mehr

Produktangaben

220-240V ~50/60Hz
Material: Gips / Stahl

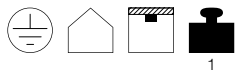

Maßzeichnung

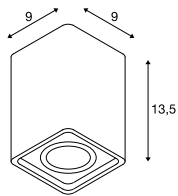

Leuchtmittlempfehlung

GU10 5,5W 36°
2800K 420lm EEK=A+
6kWh/1000h
Art. Nr. 1001217



LED GU10 7,2W 36°
2700K 570lm EEK=A+
8kWh/1000h
Art. Nr. 560552



Leuchtmittelangaben

max. 35W QPAR51

Variante	Art. Nr.
GU10 QPAR51 □ weiß	148004

PLASTRA 15
CL, single, QPAR51



E-A++ Spektrum A++-E



- Individuell gestaltbar mit Farben, Stickers & mehr

Produktangaben

220-240V ~50/60Hz
Material: Gips / Stahl

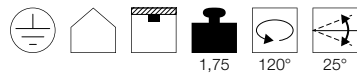

Maßzeichnung

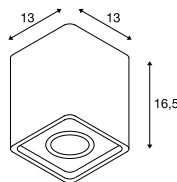

Leuchtmittlempfehlung

LED GU10 5,5W 38°
2700K 400lm EEK=A+
6kWh/1000h
Art. Nr. 1001030



LED GU10 7W 25/40/55°
3000K 300lm EEK=A
7kWh/1000h
Art. Nr. 560603



Leuchtmittelangaben

max. 35W QPAR51

Variante	Art. Nr.
GU10 QPAR51 □ weiß	148051

148004 272



148051 272





148052 273



148053 273



148052 273

PLASTRA 25
CL, double, QPAR51



E-A++ Spektrum A++-E



- Individuell gestaltbar mit Farben, Stickers & mehr

Produktangaben

220-240V ~50/60Hz
Material: Gips / Stahl

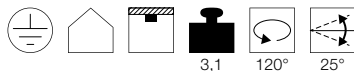

Maßzeichnung

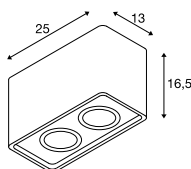

PLASTRA 35
CL, triple, QPAR51



E-A++ Spektrum A++-E



- Individuell gestaltbar mit Farben, Stickers & mehr

Produktangaben

220-240V ~50/60Hz
Material: Gips / Stahl

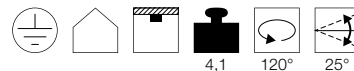

Maßzeichnung

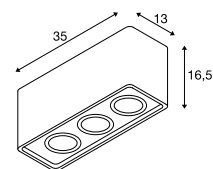

Leuchtmittlempfehlung

LED GU10 5,5W 38°
2700K 400lm EEK=A+
6kWh/1000h
Art. Nr. 1001030



LED GU10 7,2W 36°
2700K 570lm EEK=A+
8kWh/1000h
Art. Nr. 560552



Leuchtmittelangaben

2x max. 35W QPAR51

Variante	Art. Nr.
GU10 QPAR51 □ weiß	148052

Leuchtmittlempfehlung

LED GU10 7,2W 36°
4000K 540lm EEK=A+
8kWh/1000h
Art. Nr. 1001564



LED GU10 7W 25/40/55°
3000K 300lm EEK=A
7kWh/1000h
Art. Nr. 560603



Leuchtmittelangaben

3x max. 35W QPAR51

Variante	Art. Nr.
GU10 QPAR51 □ weiß	148053

KARDAMOD
CL, square, single, QPAR111

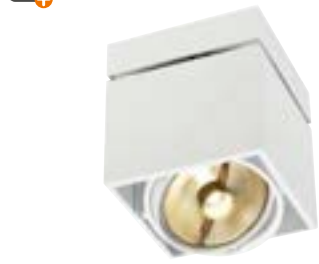

Produktangaben

230V ~50Hz
Material: Stahl

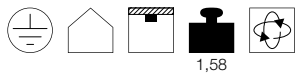

1,58

Maßzeichnung

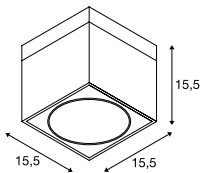

KARDAMOD
CL, square, double, QPAR111

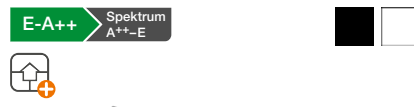

Produktangaben

230V ~50Hz
Material: Stahl

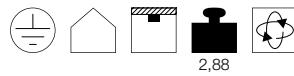

2,88

Maßzeichnung

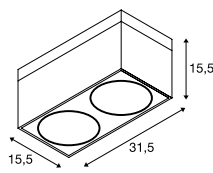

Leuchtmittlempfehlung

GU10 6,5W 38°
2700K 390lm EEK=A+
7kWh/1000h
Art. Nr. 551882



LED GU10 6,5W 30°
3000K 420lm EEK=A+
7kWh/1000h
Art. Nr. 551912



Leuchtmittelangaben

max. 75W QPAR111

Variante	Art. Nr.
GU10 QPAR111	
■ matt schwarz	117100
GU10 QPAR111	
□ weiß	117101

Leuchtmittlempfehlung

LED GU10 13W 30°
4000K 1300lm EEK=A+
13kWh/1000h
Art. Nr. 1001243



LED GU10 13W 140°
4000K 1100lm EEK=A+
13kWh/1000h
Art. Nr. 1001245



Leuchtmittelangaben

2x max. 75W QPAR111

Variante	Art. Nr.
GU10 QPAR111	
■ matt schwarz	117110
GU10 QPAR111	
□ weiß	117111

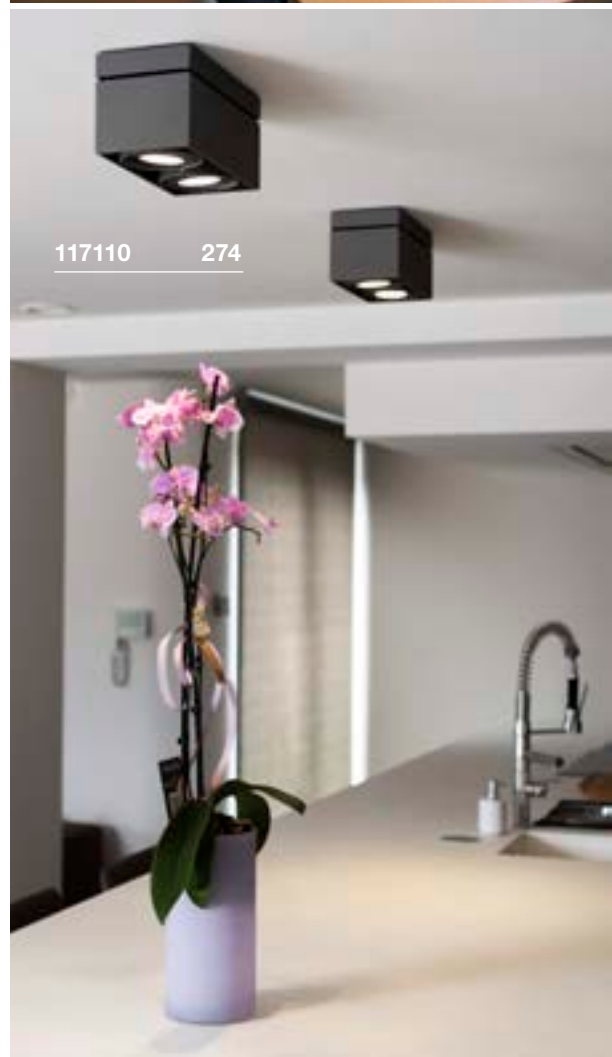



117111 274

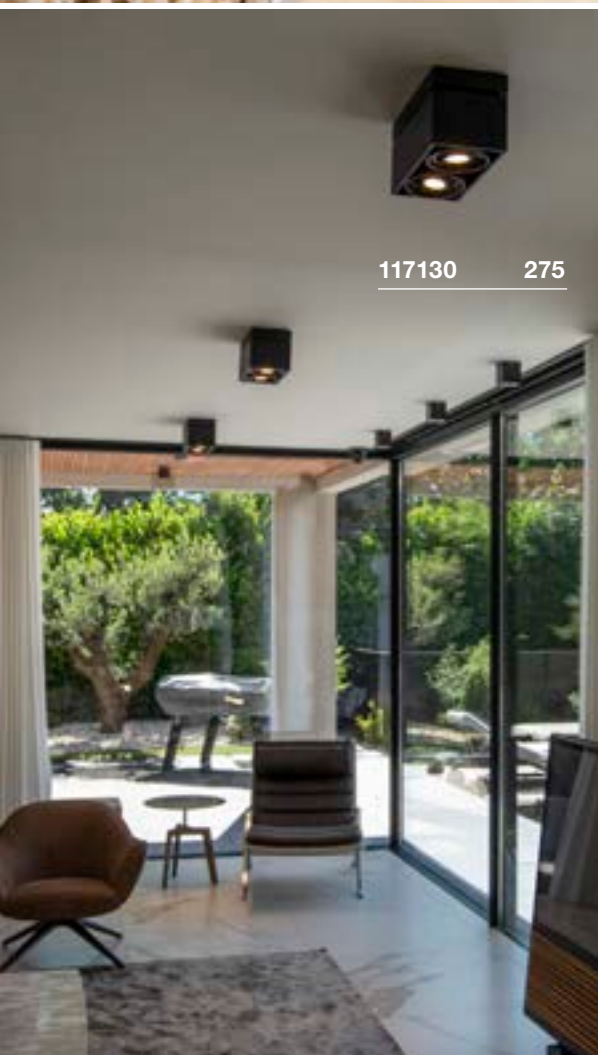

117130 275

KARDAMOD
CL, square, single, QR111

D-A+ Spektrum A++-E



Produktangaben

230V ~50Hz | 12V AC
Material: Stahl
Dimmbar: C

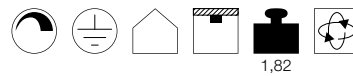

1,82

Maßzeichnung

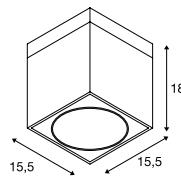

KARDAMOD
CL, square, double, QR111

E-A++ Spektrum A++-E



Produktangaben

230V ~50Hz | 12V AC
Material: Stahl
Dimmbar: C

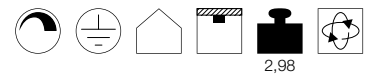

2,98

Maßzeichnung

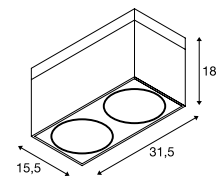

Leuchtmittlempfehlung

LED G53 15W 24°
2700K 760lm EEK=A
17kWh/1000h
Art. Nr. 560231



LED G53 15W 40°
2700K 750lm EEK=A
17kWh/1000h
Art. Nr. 560232



Leuchtmittelangaben

max. 75W QR111

Variante	Art. Nr.
G53 QR111	
■ matt schwarz	117120
G53 QR111	
□ weiß	117121

Leuchtmittlempfehlung

LED G53 15W 24°
2700K 760lm EEK=A
17kWh/1000h
Art. Nr. 560231



LED G53 15W 40°
2700K 750lm EEK=A
17kWh/1000h
Art. Nr. 560232



Leuchtmittelangaben

2x max. 50W QR111

Variante	Art. Nr.
G53 QR111	
■ matt schwarz	117130
G53 QR111	
□ weiß	117131

KARDAMOD
CL, round, single, QPAR111



Produktangaben

230V ~50Hz
Material: Stahl

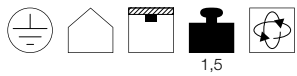

Maßzeichnung

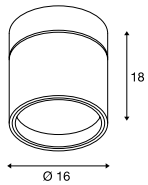

Leuchtmittlempfehlung

GU10 6,5W 38°
2700K 390lm EEK=A+
7kWh/1000h
Art. Nr. 551882



LED GU10 6,5W 30°
3000K 420lm EEK=A+
7kWh/1000h
Art. Nr. 551912



Leuchtmittelangaben

max. 75W QPAR111

Variante	Art. Nr.
GU10 QPAR111	
■ matt schwarz	117160
GU10 QPAR111	
□ weiß	117161

KARDAMOD
CL, round, double, QPAR111

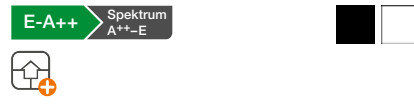

Produktangaben

230V ~50Hz
Material: Stahl

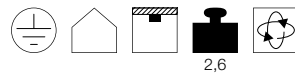

Maßzeichnung

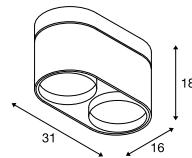

Leuchtmittlempfehlung

LED GU10 13W 30°
4000K 1300lm EEK=A+
13kWh/1000h
Art. Nr. 1001243



LED GU10 13W 140°
4000K 1100lm EEK=A+
13kWh/1000h
Art. Nr. 1001245



Leuchtmittelangaben

2x max. 75W QPAR111

Variante	Art. Nr.
GU10 QPAR111	
■ matt schwarz	117180
GU10 QPAR111	
□ weiß	117181

117181 276



114181 277



SUPROS CL



A-A++ Spektrum A++-E



Produktangaben

220-240V ~50/60Hz | 950mA
Systemleistung: 36W
Material: Aluminium / Glas

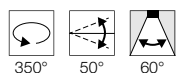
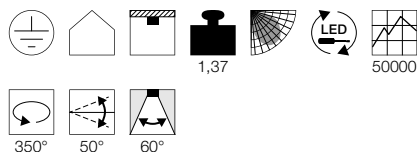

Maßzeichnung

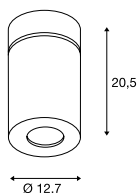

Zubehörempfehlung

Reflek or 20°

Art. Nr. 114102



Reflek or 40°

Art. Nr. 114104



Variante	Art. Nr.
3100lm 3000K CRI>80	
■ schwarz	118130
3100lm 3000K CRI>80	
□ weiß / transparent	118131
3300lm 4000K CRI>80	
■ schwarz	118180
3300lm 4000K CRI>80	
□ weiß / transparent	118181

SUPROS 78 CL, TRIAC



A-A++ Spektrum A++-E



Produktangaben

220-240V ~50/60Hz | 250mA
Systemleistung: 12W
Material: Aluminium
Dimmbar: Triac C, Triac L

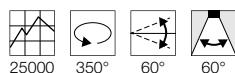
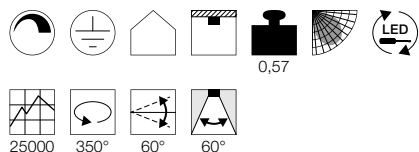

Maßzeichnung

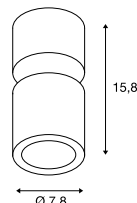

Zubehörempfehlung

Linse 20°

Art. Nr. 116302



Linse 40°

Art. Nr. 116304



Variante	Art. Nr.
700lm 3000K CRI>80	
■ schwarz	116330
700lm 3000K CRI>80	
□ weiß	116331

SUPROS CL, Move



A-A++ Spektrum A++-E



Produktangaben

220-240V ~50/60Hz | 750mA
Systemleistung: 31W
Material: Aluminium / Glas

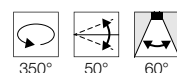
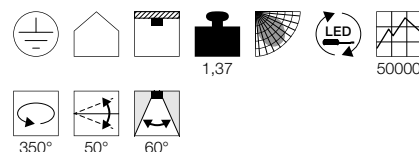

Maßzeichnung

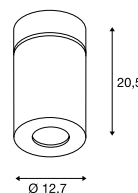

Zubehörempfehlung

Reflek or 20°

Art. Nr. 114102



Reflek or 40°

Art. Nr. 114104



Variante	Art. Nr.
2850lm 4000K CRI>80	
■ schwarz	114180
2850lm 4000K CRI>80	
□ weiß / transparent	114181
2600lm 3000K CRI>80	
■ schwarz	114130
2600lm 3000K CRI>80	
□ weiß / transparent	114131

FÜR STRAHLENDE AUFTRITTE.

WAND- UND DECKENLEUCHTEN KOMBINIEREN.

Während Deckenleuchten in Sachen Licht den Ton angeben, setzen Wandleuchten individuelle Akzente. Für eine ganzheitliche Lichtlösung ist darum eine Kombination aus beidem ideal – und die bietet so viele Variationsmöglichkeiten, dass der Kreativität keine Grenzen gesetzt sind.

1000887 299



1002974 297



WAND- UND DECKENLEUCHTEN

 282	 283	 283	 284	 285	 286	 286	 287
 288	 289	 289	 290	 290	 291	 291	 292
 292	 295	 295	 295	 297	 297	 297	 299
 299	 299	 299	 301	 301	 301	 301	 303
 303	 303	 303	 304	 304	 304	 304	 306
 306	 306	 307	 307	 307	 310	 310	 310
 311	 311	 311	 312	 312	 312	 313	 313
 314	 315	 315	 315	 316	 317	 317	 318
 319	 319	 319	 321	 321	 321	 322	 324
 324	 324	 325	 325	 325	 327	 327	 328
 328	 329	 329					

SPOT
CW, E27



D-A+ Spektrum
A++-E



1002072 282

Produktangaben

230V ~50Hz
Material: Aluminium

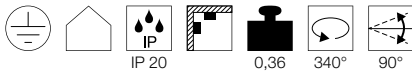

Maßzeichnung

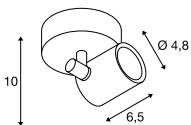

Leuchtmittlempfehlung

LED E27 11,5W 38°
3000K 760lm EEK=A+
12kWh/1000h
Art. Nr. 551933



LED E27 17W 45°
3000K 1430lm EEK=A+
17kWh/1000h
Art. Nr. 560473



Leuchtmittelangaben

max. 75W QPAR20
optional: QPAR30

Variante	Art. Nr.
E27 QPAR20	
■ schwarz	1002072
E27 QPAR20	
□ weiß	1002073
E27 QPAR20	
■ grau	1002074





132020 283

SPOT 79
CW, QPAR51

E-A++ Spektrum A++-E



Produktangaben

230V ~50Hz
Material: Aluminium

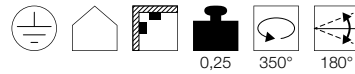

0,25 350° 180°

Maßzeichnung

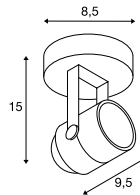

Leuchtmittlempfehlung

LED GU10 5,5W 38°
2700K 400lm EEK=A+
6kWh/1000h
Art. Nr. 1001030



LED GU10 7,2W 36°
2700K 570lm EEK=A+
8kWh/1000h
Art. Nr. 560552



Leuchtmittelangaben

max. 50W QPAR51
Ø: 5 cm max. L: 5,7 cm max.

Variante	Art. Nr.
GU10 QPAR51	
■ schwarz	132020
□ weiß	132021
■ grau	132024

INDA
CW, QPAR51

E-A++ Spektrum A++-E



Produktangaben

230V ~50Hz
Material: Aluminium

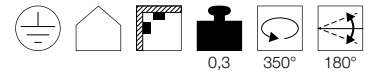

0,3 350° 180°

Maßzeichnung

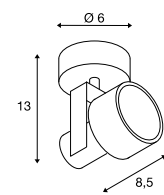

Leuchtmittlempfehlung

LED GU10 7,2W 36°
4000K 540lm EEK=A+
8kWh/1000h
Art. Nr. 1001565



LED GU10 7,2W 36°
2700K 520lm EEK=A+
8kWh/1000h
Art. Nr. 1001560



Leuchtmittelangaben

max. 50W QPAR51
Ø: 5 cm max. L: 5,7 cm max.

Variante	Art. Nr.
GU10 QPAR51	
■ matt schwarz	147550
□ matt weiß	147551
■ matt aluminium	147559



147559 283

ALTRA DICE
CW, double, QPAR51

883

E-A++

Spektrum
A++-E

1002215 284



- Komplette Leuchte drehbar

Produktangaben

220-240V ~50/60Hz
Material: Aluminium / Stahl

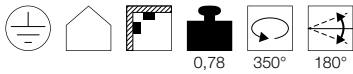

0,78 350° 180°

Maßzeichnung

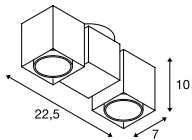

Leuchtmittlempfehlung

LED GU10 4,3W 40°
3000K 375lm EEK=A++
5kWh/1000h

Art. Nr. 560143



LED GU10 5,5W 36°
2800K 420lm EEK=A+
6kWh/1000h

Art. Nr. 1001217



Leuchtmittelangaben

2x max. 50W QPAR51

Variante	Art. Nr.
GU10 QPAR51	
□ weiß	151531
GU10 QPAR51	
■ grau / schwarz	151534
GU10 QPAR51	
■ schwarz	1002215





1002585 285

FITU
CW, E27E-A++ Spektrum
A++-E

Produktangaben

220-240V ~50/60Hz
Material: Aluminium / Stahl



0,31 330° 120°

Maßzeichnung

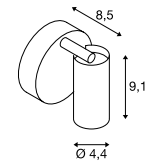

1002584 285



Leuchtmittelempfehlung

LED E27 8W 350°
2200K 250lm EEK=B
8kWh/1000h
Art. Nr. 1002123



LED E27 10,5W 360°
2700K 1000lm EEK=A+
10,5kWh/1000h
Art. Nr. 1001756



Leuchtmittelangaben

max. 60W

Variante	Art. Nr.
E27 weiß	1002584
E27 schwarz	1002585

KARPO 30
CW, single



A-A++ Spektrum A+-E



- Premium LED mit CRI>90

Produktangaben

100-240V ~50/60Hz | 500mA
Systemleistung: 9,5W
Material: Aluminium / Stahl

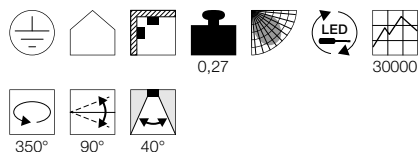

Maßzeichnung

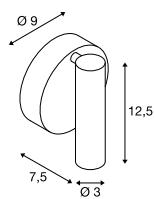

KARPO 30
CW, single, TRIAC



A-A++ Spektrum A+-E

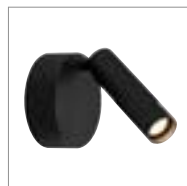

- Premium LED mit CRI>90
- Dimmbar

Produktangaben

220-240V ~50/60Hz | 500mA
Systemleistung: 9W
Material: Aluminium / Stahl
Dimmbar: Triac C

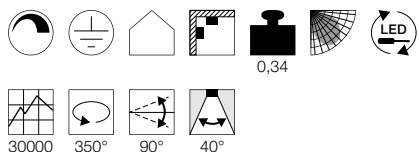

Maßzeichnung

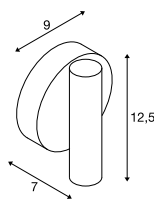

Variante	Art. Nr.
580lm 3000K CRI>90	
■ schwarz	1001495
600lm 3000K CRI>90	
□ weiß	1001496

152331 286



Variante	Art. Nr.
480lm 3000K CRI>90	
■ schwarz	152330
530lm 3000K CRI>90	
□ weiß	152331
530lm 3000K CRI>90	
■ gold	1002175



1000247 287

TOTHEE
CW, TRIACA-A++ Spektrum
A++-ELED
INSIDE

Produktangaben

220-240V ~50/60Hz | 350mA
 Systemleistung: 17W
 Material: Aluminium
 Dimmbar: Triac C, Triac L

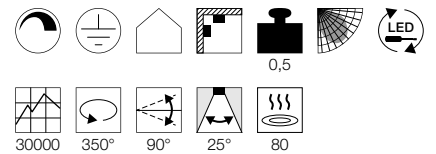

Maßzeichnung

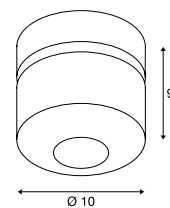

Variante	Art. Nr.
1250lm 3000K CRI>80	
■ schwarz	1000424
1250lm 3000K CRI>80	
■ weiß / schwarz	1000425
1250lm 3000K CRI>80	
■ schwarz	1000426
1250lm 3000K CRI>80	
■ weiß / schwarz	1000427

BILAS
CW, single, TRIAC



A-A++ Spektrum A++-E



• Hochvolt LED

Produktangaben

230V ~50/60Hz
Systemleistung: 16W
Material: Aluminium / Glas
Dimmbar: Triac C, Triac L

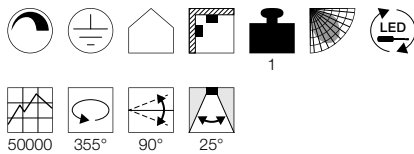

Maßzeichnung

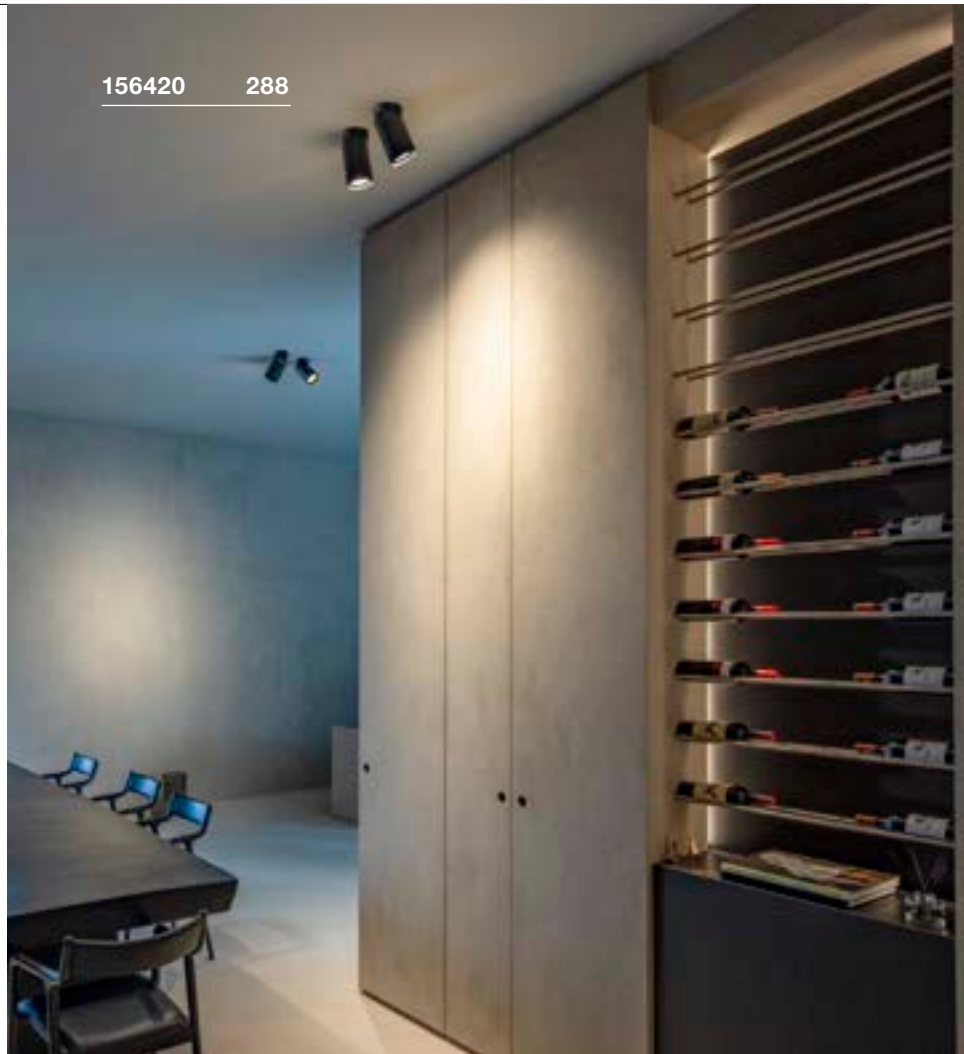
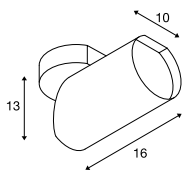

156420 288

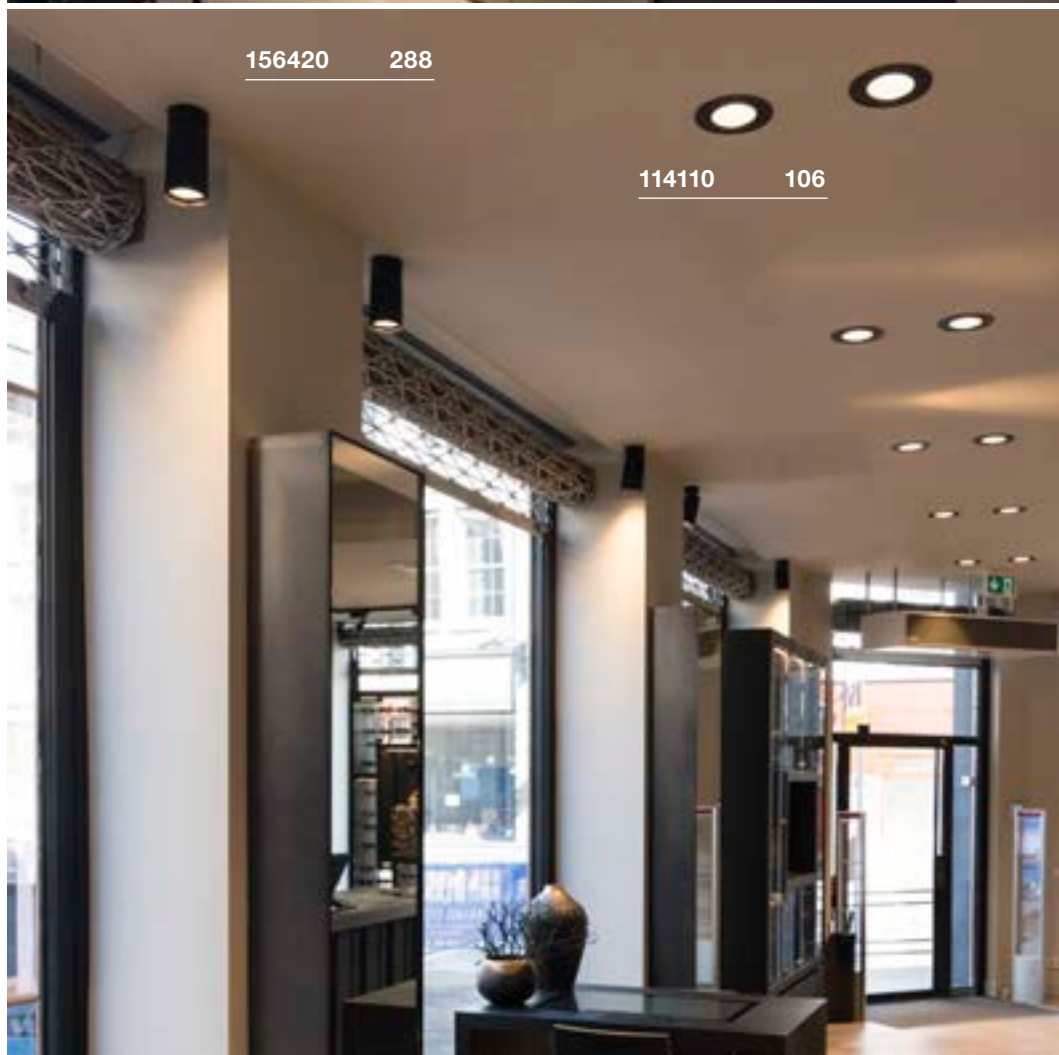

156420 288

114110 106

Variante	Art. Nr.
1000lm 2700K CRI>80	
■ matt schwarz	156420
1000lm 2700K CRI>80	
□ matt weiß	156421

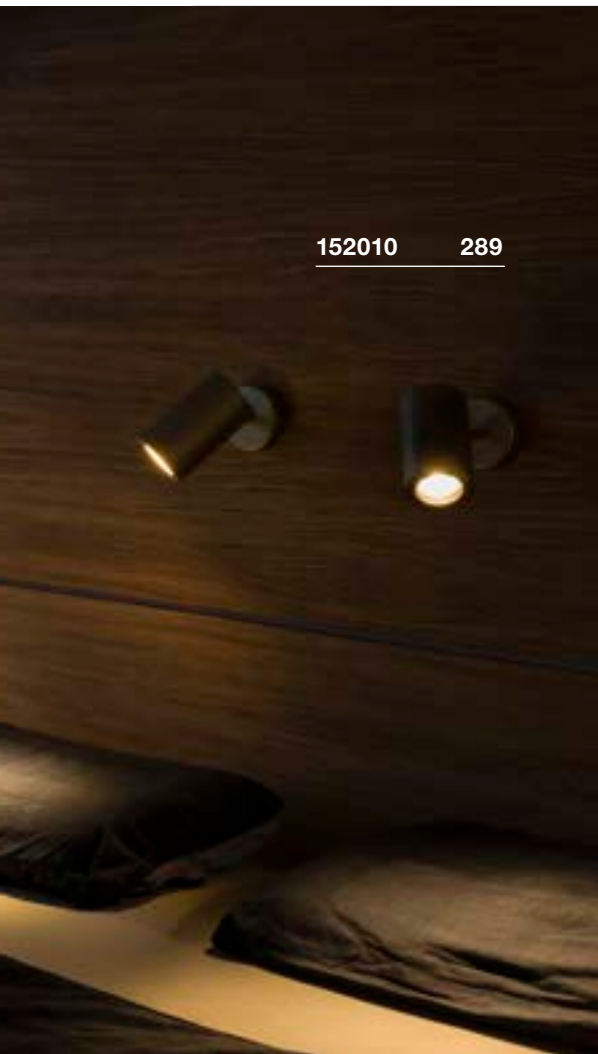

152010 289



152023 289

ENOLA B
CW, single, QPAR51



E-A++ Spektrum A++-E



Produktangaben

220-240V ~50/60Hz
Material: Aluminium / Stahl

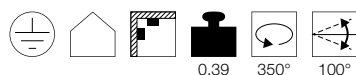

Maßzeichnung

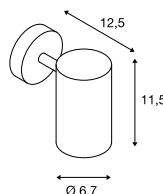

Hinweis

Zierring in Leuchtenfarbe inkl.
Optionaler schwarzer Zierring als Zubehör erhältlich.

Zubehörempfehlung

■ Zierring
Art. Nr. 151840

Leuchtmittlempfehlung

LED GU10 7,2W 36°
4000K 540lm EEK=A+
8kWh/1000h
Art. Nr. 1001565

LED GU10 7,2W 36°
2700K 520lm EEK=A+
8kWh/1000h
Art. Nr. 1001560

Leuchtmittelangaben

max. 50W QPAR51
L: 6,7 cm max.

Variante	Art. Nr.
GU10 QPAR51	
■ schwarz	152010
□ weiß	152011
■ gold	152013

ENOLA B
CW, double, QPAR51



E-A++ Spektrum A++-E



Produktangaben

220-240V ~50/60Hz
Material: Aluminium / Stahl

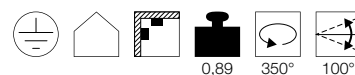

Maßzeichnung

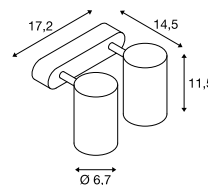

Hinweis

Zierring in Leuchtenfarbe inkl.
Optionaler schwarzer Zierring als Zubehör erhältlich.

Zubehörempfehlung

■ Zierring
Art. Nr. 151840

Leuchtmittlempfehlung

GU10 5,5W 36°
2800K 420lm EEK=A+
6kWh/1000h
Art. Nr. 1001217

LED GU10 5,5W 38°
2700K 400lm EEK=A+
6kWh/1000h
Art. Nr. 1001030

Leuchtmittelangaben

2x max. 50W QPAR51
L: 6,7 cm max.

Variante	Art. Nr.
GU10 QPAR51	
■ schwarz	152020
□ weiß	152021
■ gold	152023

ENOLA B
CW, single, QPAR51



E-A++ Spektrum A++-E



ENOLA B
CW, double, QPAR51



E-A++ Spektrum A++-E



Produktangaben

220-240V ~50/60Hz
Material: Aluminium / Stahl



0,53 350° 180°

Produktangaben

220-240V ~50/60Hz
Material: Aluminium / Stahl

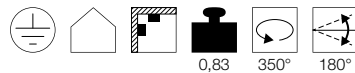

0,83 350° 180°

Maßzeichnung

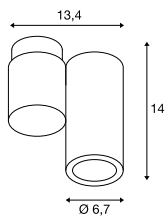

Maßzeichnung

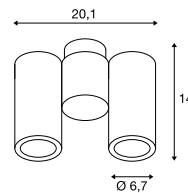

Hinweis

Zierring in Leuchtenfarbe inkl.
Optionaler schwarzer Zierring als Zubehör erhältlich.

Hinweis

Zierring in Leuchtenfarbe inkl.
Optionaler schwarzer Zierring als Zubehör erhältlich.

Zubehörempfehlung

■ Zierring
Art. Nr. 151840



Zubehörempfehlung

■ Zierring
Art. Nr. 151840



Leuchtmittlempfehlung

GU10 5,5W 36°
2800K 420lm EEK=A+
6kWh/1000h
Art. Nr. 1001217



LED GU10 5,5W 38°
2700K 400lm EEK=A+
6kWh/1000h
Art. Nr. 1001030



Leuchtmittlempfehlung

LED GU10 5,5W 38°
2700K 400lm EEK=A+
6kWh/1000h
Art. Nr. 1001030



LED GU10 7,2W 36°
3000K 520lm EEK=A+
8kWh/1000h
Art. Nr. 1001562



Leuchtmittelangaben

max. 50W QPAR51
L: 8 cm max.

Leuchtmittelangaben

2x max. 50W QPAR51
L: 8 cm max.

Variante	Art. Nr.
GU10 QPAR51	
■ schwarz	151820
GU10 QPAR51	
□ weiß	151821

Variante	Art. Nr.
GU10 QPAR51	
■ schwarz	151830
GU10 QPAR51	
□ weiß	151831

151821 290



151821 290





149070 291



149070 291

LIGHT EYE® 90
CW, single, QPAR51



E-A++ Spektrum A++-E

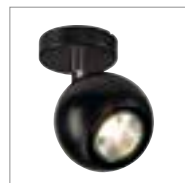

- Der optionale Dekoring für das Leuchtmittel in der passenden Farbe verringert den Abstand zwischen Gehäuse und Leuchtmittel

Produktangaben

220-240V ~50/60Hz
Material: Stahl

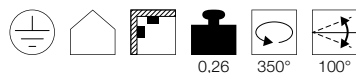

Maßzeichnung

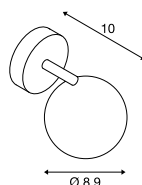

Zubehörempfehlung

- Leuchtmittel Dekoring Ø 5,7cm
Art. Nr. 151040
- Leuchtmittel Dekoring Ø 5,7cm
Art. Nr. 151041
- Leuchtmittel Dekoring Ø 5,7cm
Art. Nr. 151049

Leuchtmittlempfehlung

- LED GU10 7,2W 36°
4000K 540lm EEK=A+
8kWh/1000h
Art. Nr. 1001565
- LED GU10 7,2W 36°
2700K 520lm EEK=A+
8kWh/1000h
Art. Nr. 1001560

Leuchtmittelangaben

max. 50W QPAR51

Variante	Art. Nr.
GU10 QPAR51	
■ schwarz / chrom	149060
GU10 QPAR51	
■ weiß / chrom	149061

LIGHT EYE® 90
CW, double, QPAR51



E-A++ Spektrum A++-E

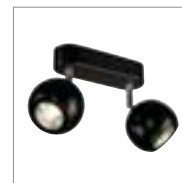

- Der optionale Dekoring für das Leuchtmittel in der passenden Farbe verringert den Abstand zwischen Gehäuse und Leuchtmittel

Produktangaben

220-240V ~50/60Hz
Material: Stahl

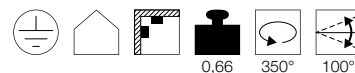

Maßzeichnung

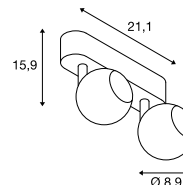

Zubehörempfehlung

- Leuchtmittel Dekoring Ø 5,7cm
Art. Nr. 151040
- Leuchtmittel Dekoring Ø 5,7cm
Art. Nr. 151041
- Leuchtmittel Dekoring Ø 5,7cm
Art. Nr. 151049

Leuchtmittlempfehlung

- GU10 5,5W 36°
2800K 420lm EEK=A+
6kWh/1000h
Art. Nr. 1001217
- LED GU10 5,5W 38°
2700K 400lm EEK=A+
6kWh/1000h
Art. Nr. 1001030

Leuchtmittelangaben

2x max. 50W LED GU10 51mm

Variante	Art. Nr.
GU10 LED GU10 51mm	
■ schwarz / chrom	149070
GU10 LED GU10 51mm	
■ weiß / chrom	149071

HELIA
CW, single, TRIAC



A-A++ Spektrum
A++-E



- Premium LED mit CRI>90

Produktangaben

220-240V ~50/60Hz | 500mA
Systemleistung: 11W
Material: Aluminium
Dimmbar: Triac C

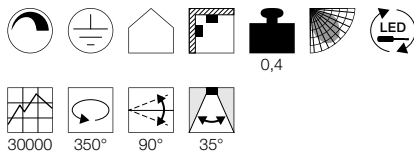

Maßzeichnung

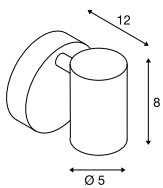

HELIA
CW, double, TRIAC



A-A++ Spektrum
A++-E



- Premium LED mit CRI>90

Produktangaben

220-240V ~50/60Hz | 500mA
Systemleistung: 18W
Material: Aluminium
Dimmbar: Triac C, Triac L

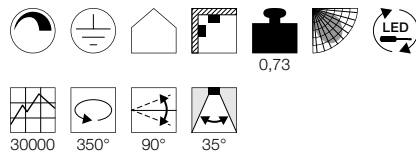

Maßzeichnung

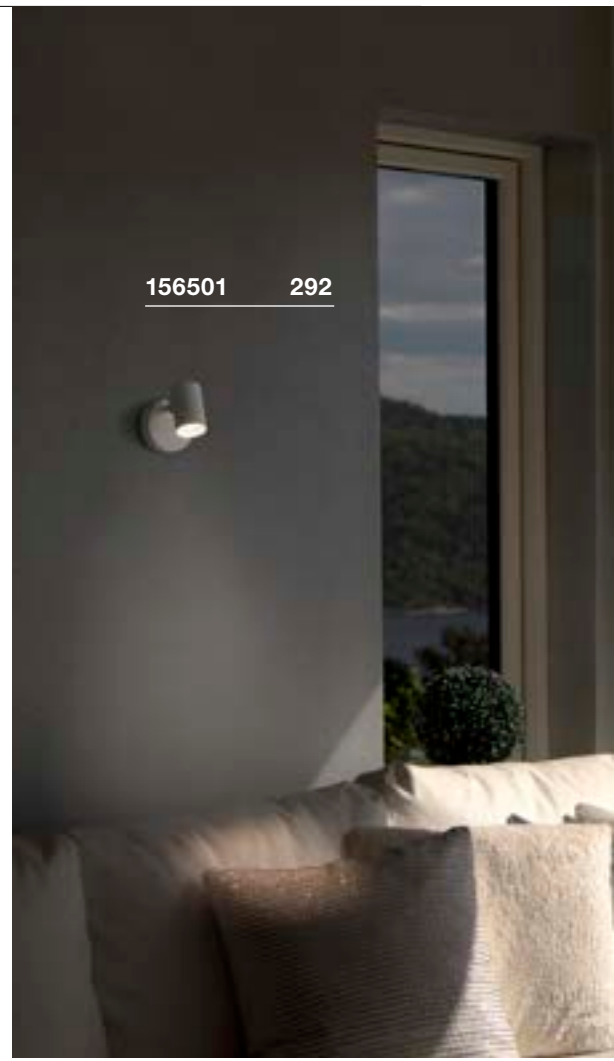
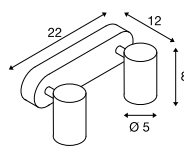

156501 292

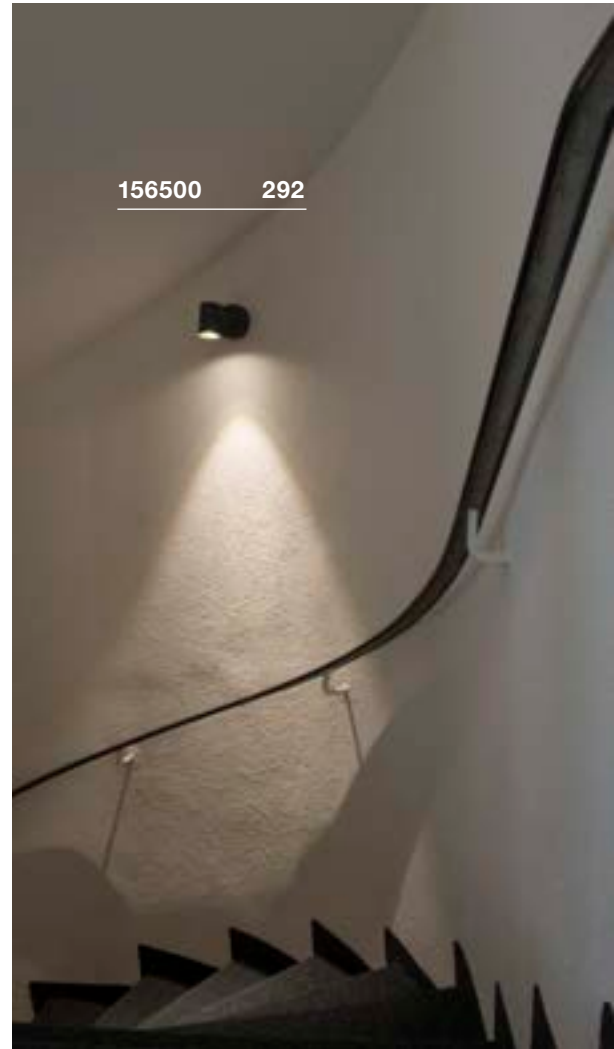

156500 292

Variante	Art. Nr.
620lm 3000K CRI>90	
■ schwarz	156500
620lm 3000K CRI>90	
□ weiß	156501

Variante	Art. Nr.
1200lm 3000K CRI>90	
■ schwarz	156510
1200lm 3000K CRI>90	
□ weiß	156511



156510 292

147412

294

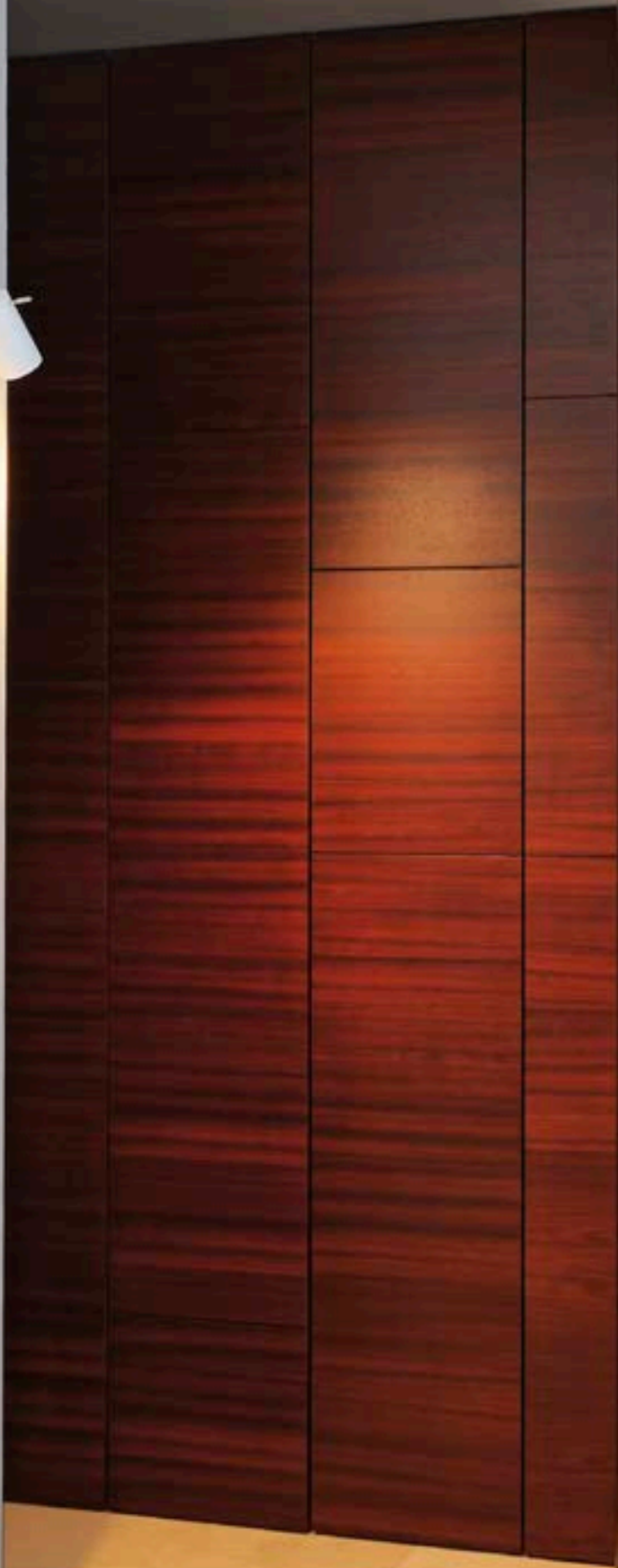

ASTO TUBE
CW, QPAR51

E-A++ Spektrum A++-E

- Einsatz von langen LED Leuchtmitteln möglich

Produktangaben

230V ~50Hz
Systemleistung: 50W
Material: Aluminium

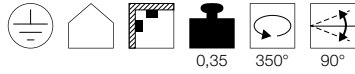

Leuchtmittlempfehlung

LED GU10 5,5W 38°
2700K 400lm EEK=A+
6kWh/1000h
Art. Nr. 1001030



LED GU10 7,2W 36°
3000K 520lm EEK=A+
8kWh/1000h
Art. Nr. 1001562



ASTO TUBE
CW, single, QPAR51



Maßzeichnung

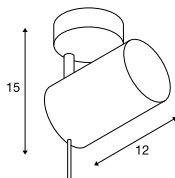

Leuchtmittelangaben

max. 50W QPAR51
Ø: 6,4 cm max. L: 8,1 cm max.

Variante	Art. Nr.
GU10 QPAR51 0,34 kg □ weiß	147411

ASTO TUBE
CW, double, QPAR51

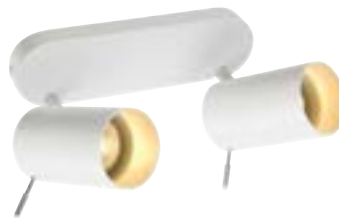

Maßzeichnung

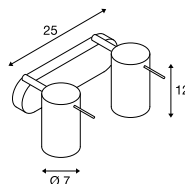

Leuchtmittelangaben

2x max. 50W QPAR51
Ø: 6,4 cm max. L: 8,1 cm max.

Variante	Art. Nr.
GU10 QPAR51 0,7 kg □ weiß	147412

ASTO TUBE
CW, triple, QPAR51



Maßzeichnung

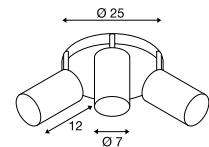

Leuchtmittelangaben

3x max. 50W QPAR51
Ø: 6,4 cm max. L: 8,1 cm max.

Variante	Art. Nr.
GU10 QPAR51 1,15 kg □ weiß	147414

1002976 297

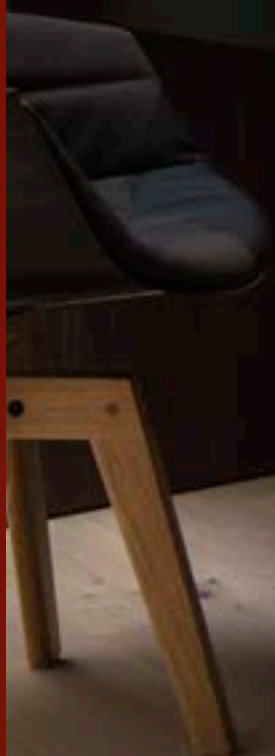

NOBLO
CW, TRIAC



A-A++ Spektrum A++-E



- Dreh- und schwenkbarer Leuchtenkopf

Produktangaben

220-240V ~50/60Hz | 350mA

Material: Aluminium

Dimmbar: Triac C, Triac L

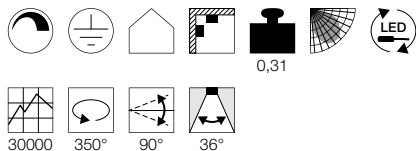

NOBLO
CW, single, TRIAC



NOBLO
CW, double, TRIAC



NOBLO
CW, triple, TRIAC



Variante	Art. Nr.
600lm 2700K CRI>80 8W L: 9 cm B: 10,5 cm H: 12,7 cm 0,31 kg ■ matt schwarz	1002969
600lm 2700K CRI>80 8W L: 9 cm B: 10,5 cm H: 12,7 cm 0,31 kg □ matt weiß	1002970
600lm 2700K CRI>80 8W L: 9 cm B: 10,5 cm H: 12,7 cm 0,31 kg ■ matt silber	1002971

Variante	Art. Nr.
1200lm 2700K CRI>80 16W L: 24 cm B: 10,5 cm H: 12,7 cm 0,67 kg ■ matt schwarz	1002973
1200lm 2700K CRI>80 16W L: 24 cm B: 10,5 cm H: 12,7 cm 0,67 kg □ matt weiß	1002974
1200lm 2700K CRI>80 16W L: 24 cm B: 10,5 cm H: 12,7 cm 0,67 kg ■ matt silber	1002975

Variante	Art. Nr.
1800lm 2700K CRI>80 24W L: 40 cm B: 10,5 cm H: 12,7 cm 1 kg ■ matt schwarz	1002976
1800lm 2700K CRI>80 24W L: 40 cm B: 10,5 cm H: 12,7 cm 1 kg □ matt weiß	1002977
1800lm 2700K CRI>80 24W L: 40 cm B: 10,5 cm H: 12,7 cm 1 kg ■ matt silber	1002978

1000889 299

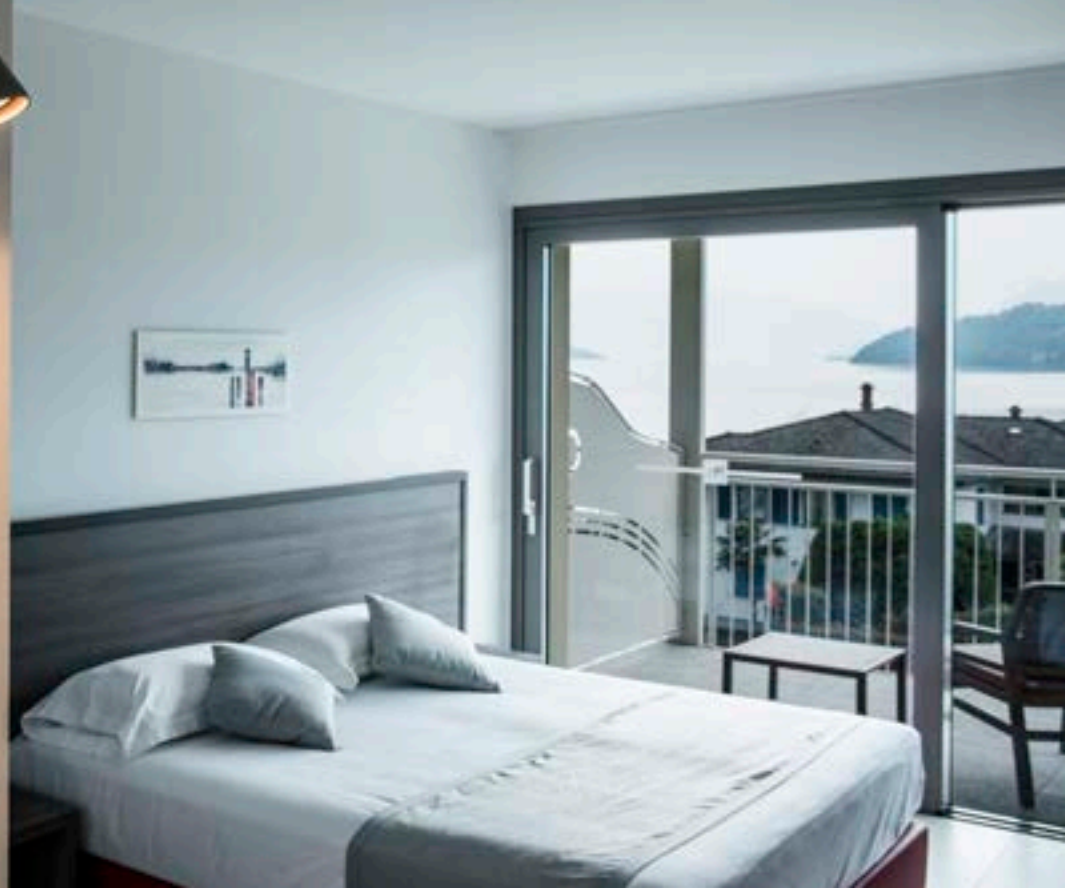

1000887 299



AVO
CW, QPAR51



Produktangaben

230V ~50Hz
Material: Stahl

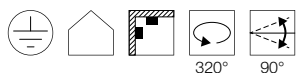

Leuchtmittelpfehlung

GU10 5,5W 36°
2800K 420lm EEK=A+
6kWh/1000h
Art. Nr. 1001217



LED GU10 5,5W 38°
2700K 400lm EEK=A+
6kWh/1000h
Art. Nr. 1001030



LED GU10 7,2W 36°
3000K 520lm EEK=A+
8kWh/1000h
Art. Nr. 1001562



AVO
CW, single, QPAR51



Maßzeichnung

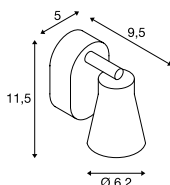

Leuchtmittelangaben

max. 50W QPAR51

Variante	Art. Nr.
GU10 QPAR51 0,22 kg	
■ schwarz	1000886
GU10 QPAR51 0,22 kg	
□ weiß	1000887
GU10 QPAR51 0,22 kg	
■ grau	1000888

AVO
CW, double, QPAR51



Maßzeichnung

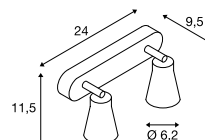

Leuchtmittelangaben

2x max. 50W QPAR51

Variante	Art. Nr.
GU10 QPAR51 0,47 kg	
■ schwarz	1000889
GU10 QPAR51 0,47 kg	
□ weiß	1000890
GU10 QPAR51 0,47 kg	
■ grau	1000891

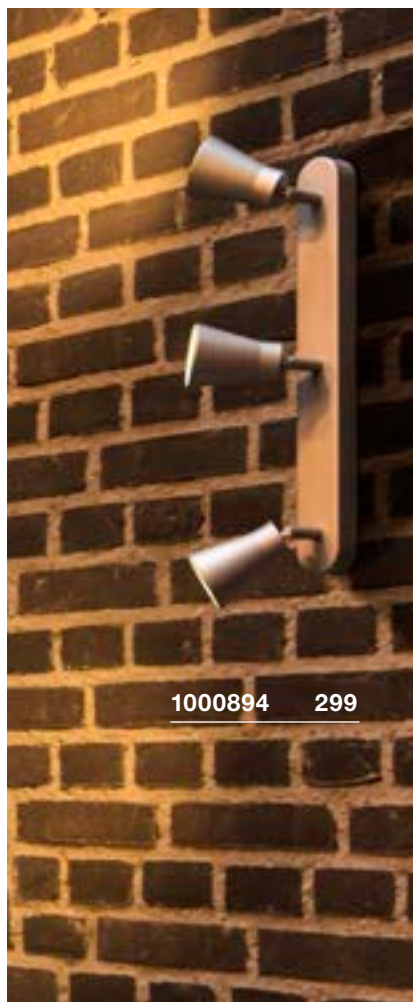

1000894 299

AVO
CW, triple, QPAR51



Maßzeichnung

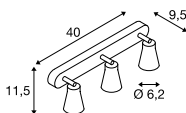

Leuchtmittelangaben

3x max. 50W QPAR51

Variante	Art. Nr.
GU10 QPAR51 0,71 kg	
■ schwarz	1000892
GU10 QPAR51 0,71 kg	
□ weiß	1000893
GU10 QPAR51 0,71 kg	
■ grau	1000894

AVO
CW, quad, QPAR51



Maßzeichnung

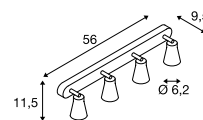

Leuchtmittelangaben

4x max. 50W QPAR51

Variante	Art. Nr.
GU10 QPAR51 1 kg	
■ schwarz	1000895
GU10 QPAR51 1 kg	
□ weiß	1000896
GU10 QPAR51 1 kg	
■ grau	1000897

147443 301



147316 304

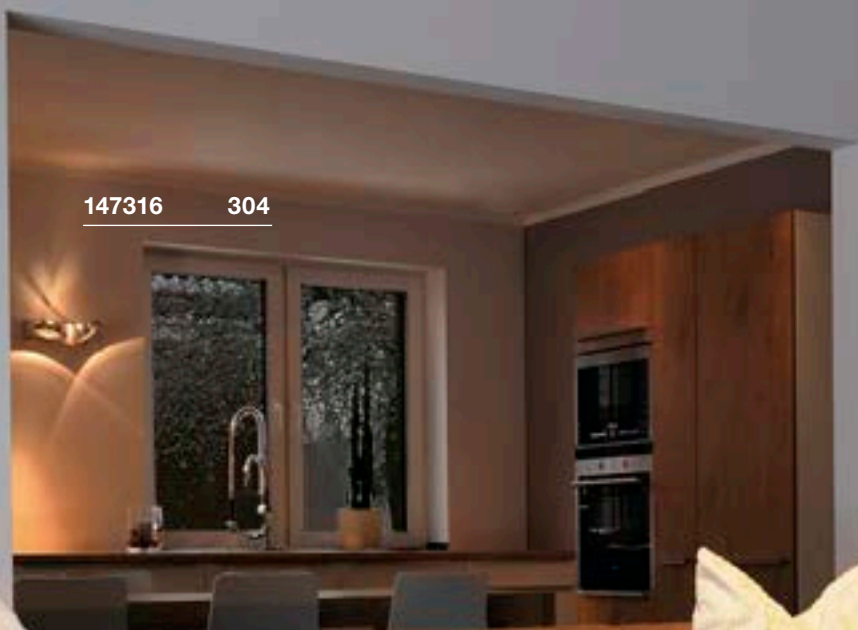

ASTO
QPAR51

E-A++ Spektrum
A++-E



Produktangaben

230V ~50Hz
Material: Aluminium

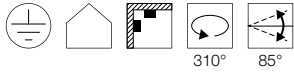

Leuchtmittlempfehlung

LED GU10 5,5W 38°
2700K 400lm EEK=A+
6kWh/1000h
Art. Nr. 1001030



ASTO
CW, single, QPAR51



Maßzeichnung

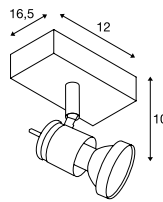

Leuchtmittelangaben

max. 50W QPAR51

Variante	Art. Nr.
GU10 QPAR51 0,25 kg ■ matt aluminium	147441

ASTO
CW, double, QPAR51



Maßzeichnung

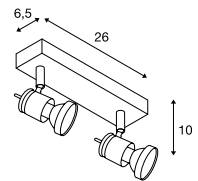

Leuchtmittelangaben

max. 75W QPAR51

Variante	Art. Nr.
GU10 QPAR51 0,35 kg ■ matt aluminium	147442



ASTO
CW, triple, QPAR51



Maßzeichnung

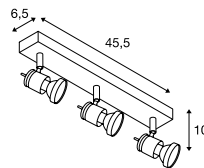

Leuchtmittelangaben

max. 75W QPAR51

Variante	Art. Nr.
GU10 QPAR51 0,55 kg ■ matt aluminium	147443

ASTO
CW, quad, QPAR51



Maßzeichnung

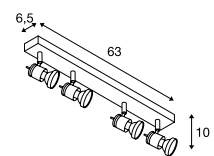

Leuchtmittelangaben

max. 75W QPAR51

Variante	Art. Nr.
GU10 QPAR51 0,8 kg ■ matt aluminium	147444



147380 303



PURI
CW, QPAR51



E-A++ Spektrum
A++-E



Produktangaben

230V ~50Hz
Material: Aluminium / Stahl

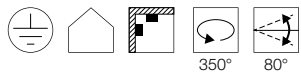

Leuchtmittelpfehlung

LED GU10 5,5W 38°
2700K 400lm EEK=A+
6kWh/1000h
Art. Nr. 1001030



LED GU10 7,2W 36°
3000K 520lm EEK=A+
8kWh/1000h
Art. Nr. 1001562



GU10 5,5W 36°
2800K 420lm EEK=A+
6kWh/1000h
Art. Nr. 1001217



PURI
CW, single, QPAR51



Maßzeichnung

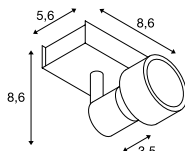

Leuchtmittelangaben

max. 50W QPAR51

Variante	Art. Nr.
GU10 QPAR51 0,27 kg	
■ matt schwarz	147360
GU10 QPAR51 0,27 kg	
□ matt weiß	147361

PURI
CW, triple, QPAR51



Maßzeichnung

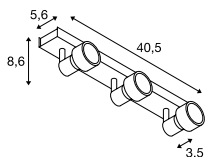

Leuchtmittelangaben

3x max. 50W QPAR51

Variante	Art. Nr.
GU10 QPAR51 0,98 kg	
■ matt schwarz	147380
GU10 QPAR51 0,98 kg	
□ matt weiß	147381

PURI
CW, double, QPAR51



Maßzeichnung

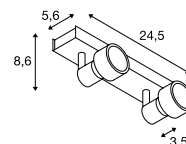

Leuchtmittelangaben

2x max. 50W QPAR51

Variante	Art. Nr.
GU10 QPAR51 0,62 kg	
■ matt schwarz	147370
GU10 QPAR51 0,62 kg	
□ matt weiß	147371

PURI
CW, quad, QPAR51



Maßzeichnung

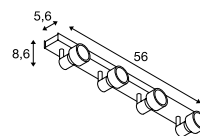

Leuchtmittelangaben

4x max. 50W QPAR51

Variante	Art. Nr.
GU10 QPAR51 1,25 kg	
■ schwarz	1002029
GU10 QPAR51 1,25 kg	
□ matt weiß	1002030



KALU
CW, QPAR111



KALU
CW, single, QPAR111



Maßzeichnung

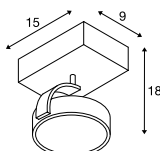

Leuchtmittelangaben

max. 75W QPAR111

Variante	Art. Nr.
GU10 QPAR111 0,44 kg	
■ schwarz	1000702
GU10 QPAR111 0,44 kg	
□ matt weiß	147301
GU10 QPAR111 0,44 kg	
■ matt aluminium	147306

KALU
CW, double, QPAR111



Maßzeichnung

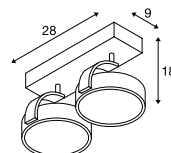

Leuchtmittelangaben

2x max. 75W QPAR111

Variante	Art. Nr.
GU10 QPAR111 0,8 kg	
■ schwarz	1000703
GU10 QPAR111 0,8 kg	
□ matt weiß	147311
GU10 QPAR111 0,8 kg	
■ matt aluminium	147316

Produktangaben

220-240V ~50/60Hz
Material: Aluminium

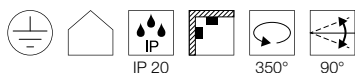

Leuchtmittlempfehlung

LED GU10 13W 30°
2700K 1100lm EEK=A+
13kWh/1000h
Art. Nr. **1001242**



LED GU10 9W 25°
2700-6500K 765lm EEK=A+
9kWh/1000h
Art. Nr. **1001920**



LED GU10 10W 38°
2700K 540lm EEK=A+
10kWh/1000h
Art. Nr. **1001028**



LED GU10 13W 140°
2700K 1000lm EEK=A+
13kWh/1000h
Art. Nr. **1001244**



KALU
CW, triple, QPAR111



Maßzeichnung

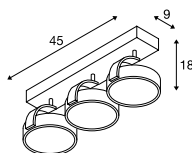

Leuchtmittelangaben

3x max. 75W QPAR111

Variante	Art. Nr.
GU10 QPAR111 1,23 kg	
■ schwarz	1000704
GU10 QPAR111 1,23 kg	
□ matt weiß	147321
GU10 QPAR111 1,23 kg	
■ matt aluminium	147326

KALU
CW, quad, QPAR111



Maßzeichnung

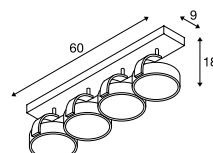

Leuchtmittelangaben

4x max. 75W QPAR111

Variante	Art. Nr.
GU10 QPAR111 1,7 kg	
■ schwarz	1002023
GU10 QPAR111 1,7 kg	
□ weiß	1002024
GU10 QPAR111 1,7 kg	
■ matt aluminium	1002025

KALU CW QPAR111
ersetzt
KALU CW QR111

Hier vergleichen
und Vorteile entdecken

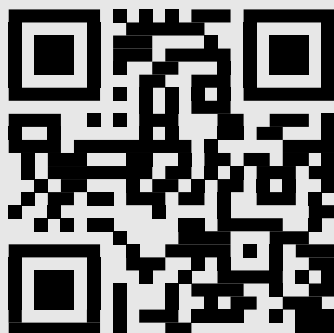

1002024 304

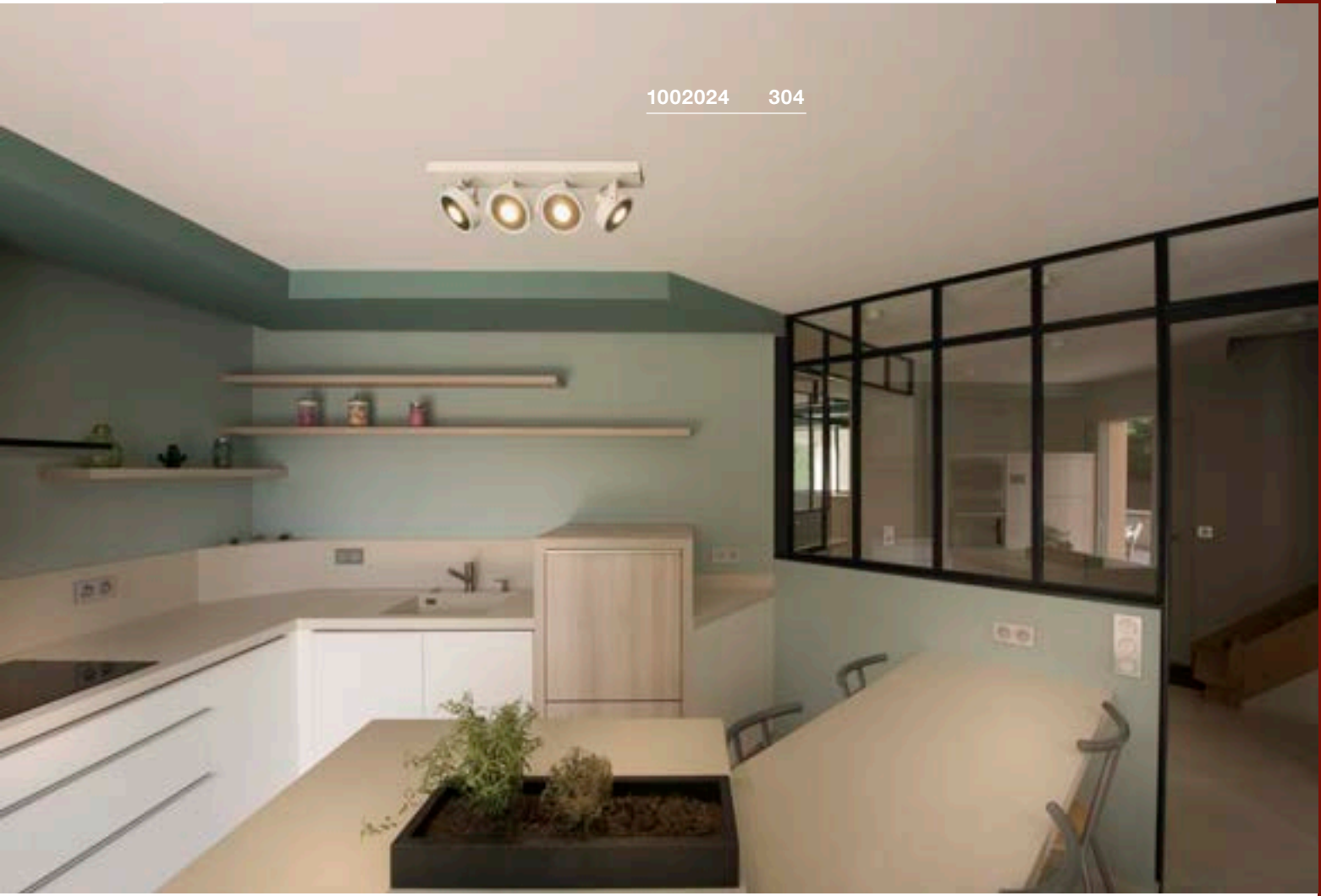

1000702 304



KALU
CW, TRIAC



A-A++ Spektrum
A++-E



- Leuchteneinheit 340° dreh- und 120° schwenkbar

Produktangaben

220-240V ~50/60Hz | 350mA
Material: Aluminium / Polycarbonat (PC)
Dimmbar: Triac C

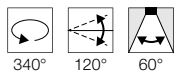
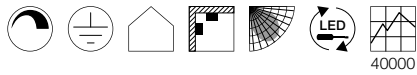

KALU
CW, single, TRIAC



Maßzeichnung

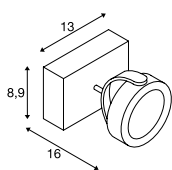

Variante	Art. Nr.
1000lm 3000K CRI>80 17W 0,77 kg ■ schwarz	1000127
1000lm 3000K CRI>80 17W 0,77 kg ■ weiß / schwarz	1000128

KALU
CW, double, TRIAC



Maßzeichnung

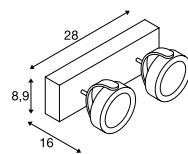

Variante	Art. Nr.
2000lm 3000K CRI>80 31W 1,6 kg ■ schwarz	1000129
2000lm 3000K CRI>80 31W 1,6 kg ■ weiß / schwarz	1000130

KALU
CW, triple, TRIAC



Maßzeichnung

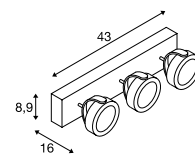

Variante	Art. Nr.
3000lm 3000K CRI>80 47W 2,2 kg ■ schwarz	1000131
3000lm 3000K CRI>80 47W 2,2 kg ■ weiß / schwarz	1000132



KALU
CW, quad, TRIAC

888

A-A++ Spektrum
A++-E



- Leuchteneinheit 340° dreh und 120° schwenkbar
- Premium LED

Produktangaben

220-240V ~50/60Hz | 700mA
Systemleistung: 60W
Material: Aluminium / Polycarbonat (PC)
Dimmbar: Triac C

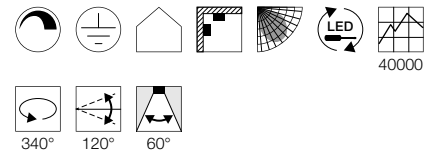

KALU
CW, quad, long, TRIAC



Maßzeichnung

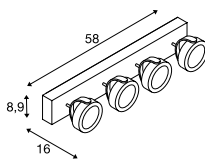

Variante	Art. Nr.
4000lm 3000K CRI>80 2,9 kg	
■ schwarz	1000133
4000lm 3000K CRI>80 2,9 kg	
■ weiß / schwarz	1000134

KALU
CW, quad, square, TRIAC



Maßzeichnung

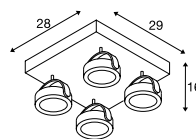

Variante	Art. Nr.
4000lm 3000K CRI>80 3,75 kg	
■ schwarz	1000135
4000lm 3000K CRI>80 3,75 kg	
■ weiß / schwarz	1000136

KALU
CW, quad, wide, TRIAC





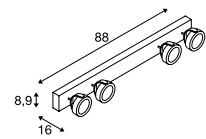



Maßzeichnung



















Variante	Art. Nr.
4000lm 3000K CRI>80 3,65 kg	
■ schwarz	1000137
4000lm 3000K CRI>80 3,65 kg	
■ weiß / schwarz	1000138





LIPSY® LEUCHTENSERIE.

FARBE NACH IHREN WUNSCH.

	LIPSY® 30 VALETO®	LIPSY® 40 VALETO®	LIPSY® 50 VALETO®
Beispiel			
Leuchtmittel			
Sensor	–	–	–
Größe	Ø: 28 cm	Ø: 39 cm	Ø: 49,6 cm
Farbtemperatur	3000K	3000K	3000K
Lichtfarbe	1400lm	1700lm	2800lm
Steuerung Dimmbar	Fernsteuerbar und dimmbar mit SLV VALETO® CCT/RGBW Fernbedienung [1002994] oder Gateway [1002411]	Fernsteuerbar und dimmbar mit SLV VALETO® CCT/RGBW Fernbedienung [1002994] oder Gateway [1002411]	Fernsteuerbar und dimmbar mit SLV VALETO® CCT/RGBW Fernbedienung [1002994] oder Gateway [1002411]

	LIPSY® 30 Dome	LIPSY® 40 Dome	LIPSY® 50 Dome	
Beispiel				
Leuchtmittel				
Sensor	–	–	–	
Größe	Ø: 30 cm	Ø: 35 cm	Ø: 40 cm	
Farbtemperatur	3000K 4000K	3000K 4000K	3000K 4000K	 <p>Bei dieser LIPSY® Variante können Sie die Farbtemperatur wählen/schalten!</p>
Lichtfarbe	1400/1600lm	1800/2000lm	2200/2400lm	
Steuerung Dimmbar	–	–	–	

	LIPSY® 30 Drum	LIPSY® 40 Drum	LIPSY® 50 Drum	
Beispiel				  Bei dieser LIPSY® Variante können Sie die Farbtemperatur wählen/schalten!
Leuchtmittel				
Sensor	-	-	-	
Größe	Ø: 30 cm	Ø: 35 cm	Ø: 40 cm	
Farbtemperatur	3000K 4000K	3000K 4000K	3000K 4000K	
Lichtfarbe	1400/1600lm	1800/2000lm	2200/2400lm	
Steuerung Dimmbar	-	-	-	

	LIPSY® 40 CW, Drum	LIPSY® 50 CW, Drum	
Beispiel			  Bei dieser LIPSY® Variante können Sie die Farbtemperatur wählen!
Leuchtmittel			
Sensor	-	-	
Größe	Ø: 35 cm	Ø: 40 cm	
Farbtemperatur	3000K 4000K	3000K 4000K	
Lichtfarbe	1800/2000lm	2200/2400lm	
Steuerung Dimmbar	-	-	

LIPSY®
CW, VALETO®

- Integrierbar in das VALETO® System

Produktangaben

230V ~50/60Hz
Systemleistung: 14,5W/17W/31,5W
Material: Polymethylacrylat (PMMA) / Stahl

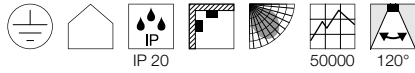

Hinweis

Fernsteuerbar und dimmbar mit SLV VALETO®
CCT/RGBW Fernbedienung [1002994] oder
Gateway [1002411]

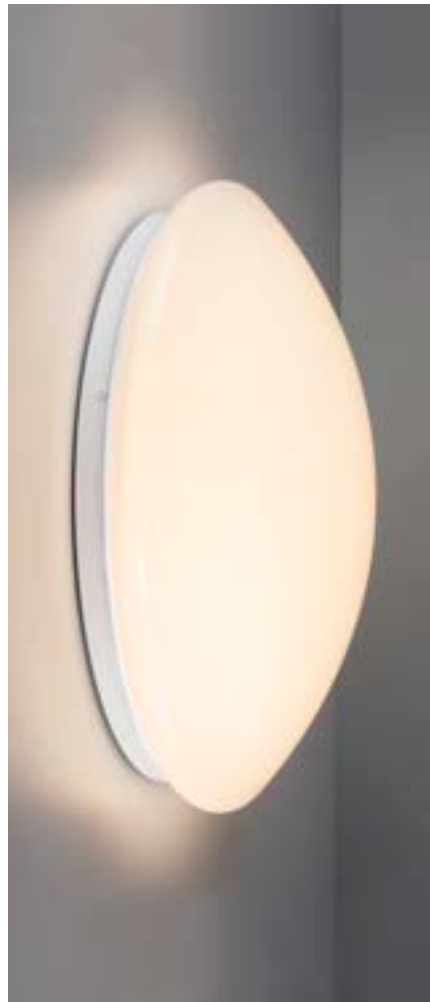

LIPSY® 30
CW, VALETO®



Maßzeichnung

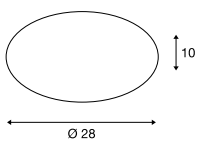

LIPSY® 40
CW, VALETO®



Maßzeichnung

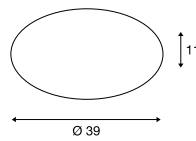

LIPSY® 50
CW, VALETO®



Maßzeichnung

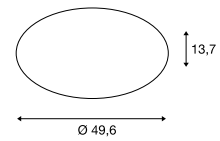

Variante	Art. Nr.
1400lm 3000K CRI>80 0,4 kg	
□ weiß	1002132

Variante	Art. Nr.
1700lm 3000K CRI>80 0,77 kg	
□ weiß	1002133

Variante	Art. Nr.
2800lm 3000K CRI>80 1,36 kg	
□ weiß	1002134

LIPSY®
CW, Dome

A-A++ Spektrum
A++-E

- Farbtemperatur (3000K/4000K) über Schalter einstellbar

Produktangaben

220-240V ~50/60Hz | 500mA
Systemleistung: 15W/18W/21W
Material: Aluminium / Polycarbonat (PC)

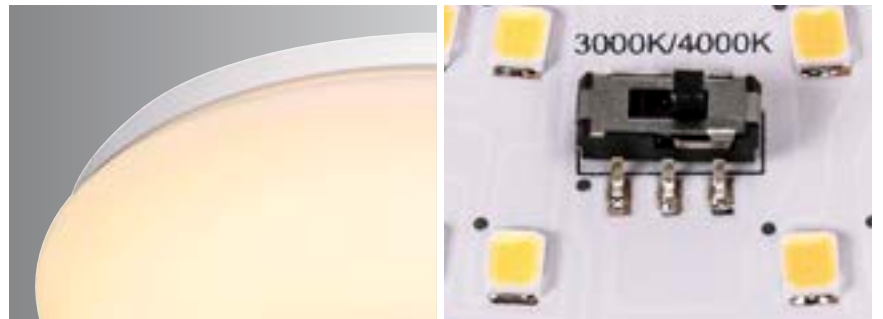
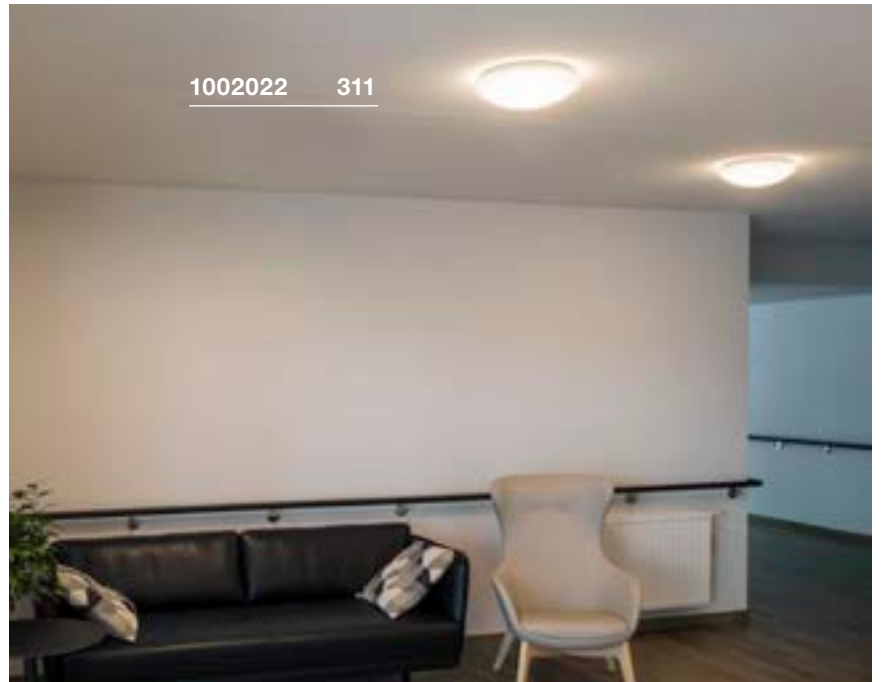
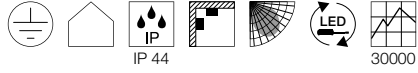

LIPSY® 30
CW, Dome



Maßzeichnung

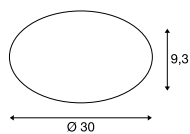

Variante	Art. Nr.
1400/1600lm 3000/4000K CRI>80 0,6 kg	
<input type="checkbox"/> weiß	1002020

LIPSY® 40
CW, Dome



Maßzeichnung

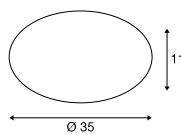

Variante	Art. Nr.
1800/2000lm 3000/4000K CRI>80 0,77 kg	
<input type="checkbox"/> weiß	1002021

LIPSY® 50
CW, Dome



Maßzeichnung

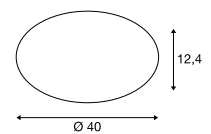

Variante	Art. Nr.
2200/2400lm 3000/4000K CRI>80 0,96 kg	
<input type="checkbox"/> weiß	1002022

LIPSY®
CW, Drum

A-A++ Spektrum
A++-E

- Farbtemperatur (3000K/4000K) über Schalter einstellbar

Produktangaben

220-240V ~50/60Hz | 500mA
Systemleistung: 15W/18W/21W
Material: Aluminium / Polycarbonat (PC)

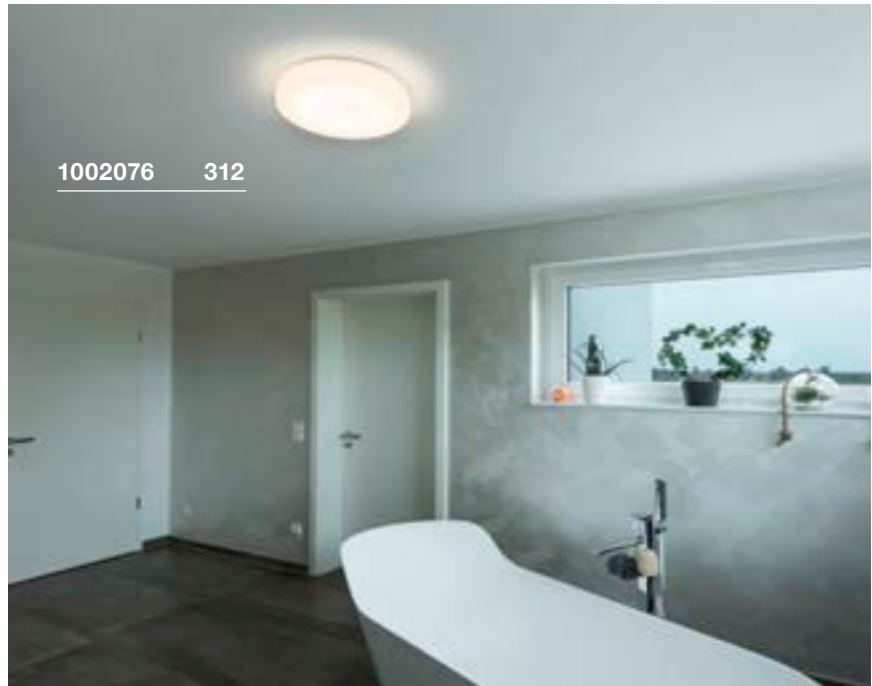
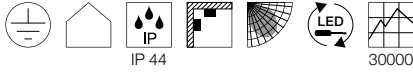

LIPSY® 30
CW, Drum



Maßzeichnung

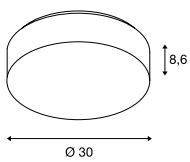

LIPSY® 40
CW, Drum



Maßzeichnung

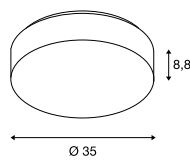

LIPSY® 50
CW, Drum



Maßzeichnung

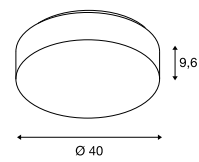

Variante	Art. Nr.
1400/1600lm 3000/4000K CRI>80 0,6 kg □ weiß	1002075

Variante	Art. Nr.
1800/2000lm 3000/4000K CRI>80 0,77 kg □ weiß	1002076

Variante	Art. Nr.
2200/2400lm 3000/4000K CRI>80 0,96 kg □ weiß	1002077

LIPSY®
CW, Drum, DALI

A-A++ Spektrum
A++-E

- Lichtfarbe schaltbar

Produktangaben

220-240V ~50/60Hz | 500mA
Systemleistung: 18W/21W
Material: Aluminium / Polycarbonat (PC)
Dimmbar: DALI

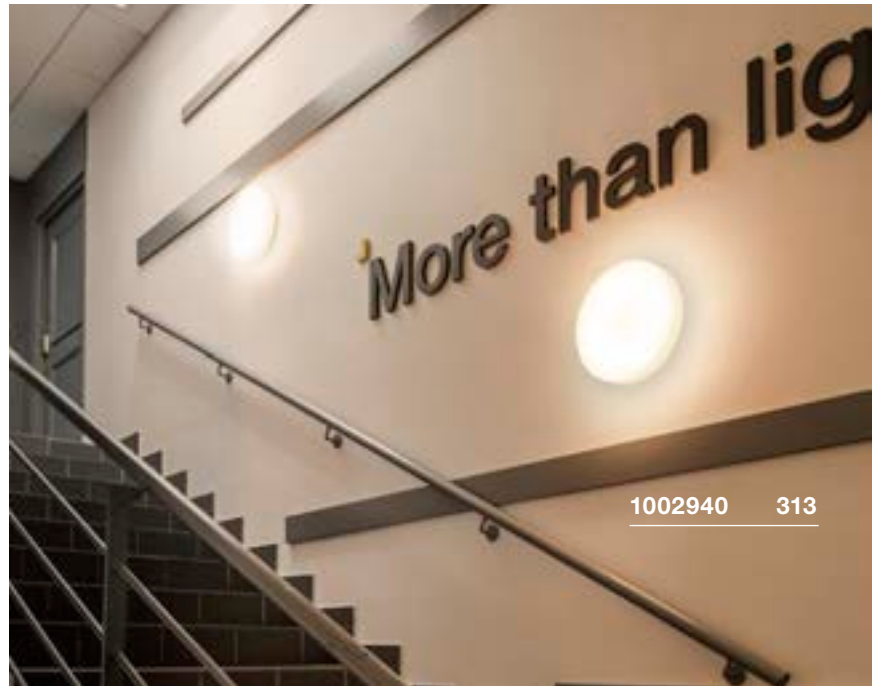
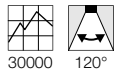
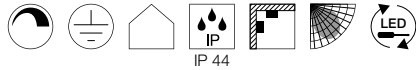

1002940 313



LIPSY® 40
CW, Drum, DALI



Maßzeichnung

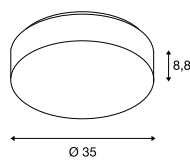

Variante	Art. Nr.
1800/2000lm 3000/4000K CRI>80 0,77 kg	
<input type="checkbox"/> weiß	1002940

LIPSY® 50
CW, Drum, DALI



Maßzeichnung

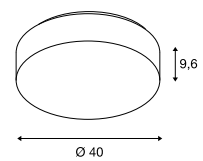

Variante	Art. Nr.
2200/2400lm 3000/4000K CRI>80 0,96 kg	
<input type="checkbox"/> weiß	1002941

MARONA
CW, TRIAC

A-A++ Spektrum A+-E



155156 314

Produktangaben

200-240V ~50/60Hz | 430mA
Systemleistung: 15W
Material: Polymethylacrylat (PMMA) / Stahl
Dimmbar: Triac C, Triac L

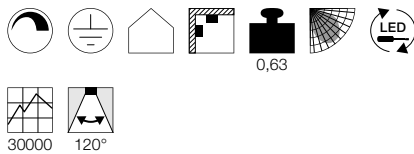

Maßzeichnung

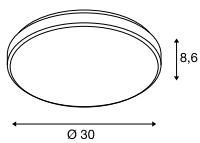

Variante	Art. Nr.
1200lm 3000K CRI>80 ■ chrom	155152
1200lm 3000K CRI>80 ■ matt grau	155156

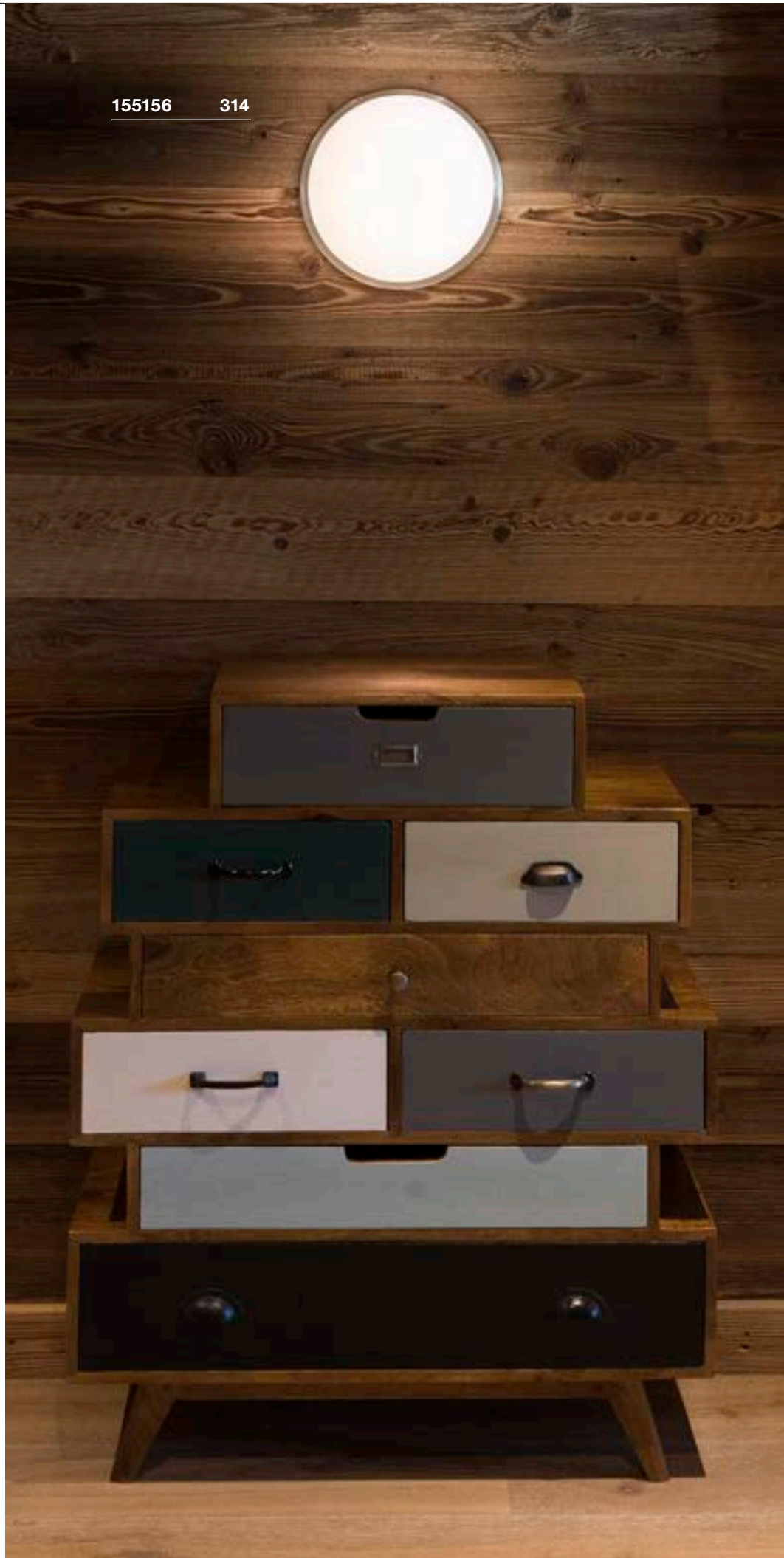

MOLDI 32
CW

A-A++ Spektrum A++-E

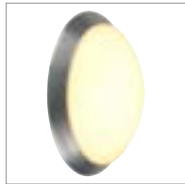

- Premium LED

Produktangaben

100-240V ~50/60Hz | 450mA
Systemleistung: 22W
Material: Aluminium/Kunststoff P



Maßzeichnung

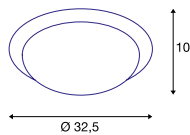

MOLDI 46
CW

A-A++ Spektrum A++-E

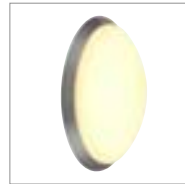

- Premium LED

Produktangaben

100-240V ~50/60Hz | 700mA
Systemleistung: 34W
Material: Aluminium/Kunststoff P

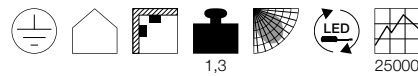

Maßzeichnung

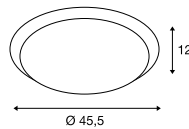

MOLDI 46
CW, Sensor

A-A++ Spektrum A++-E

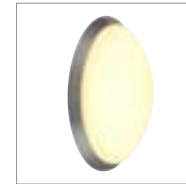

- Premium LED
- Mit integriertem MR (Mikrowellensensor)

Produktangaben

100-240V ~50/60Hz | 700mA
Systemleistung: 34W
Material: Aluminium/Kunststoff P

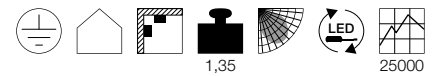

Maßzeichnung

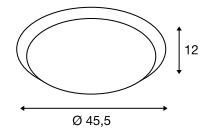



Variante	Art. Nr.
1150lm 3000K CRI>80 ■ matt aluminium	134323

Variante	Art. Nr.
2010lm 3000K CRI>80 ■ matt aluminium	134333

Variante	Art. Nr.
2010lm 3000K CRI>80 ■ matt aluminium	134343

MELAN
CW, E27

E-A++ Spektrum
A++-E 

 +



Produktangaben

230V ~50Hz
Material: Aluminium / Glas

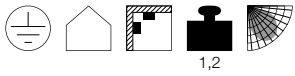

Maßzeichnung

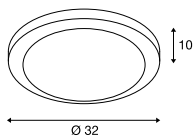

Leuchtmittelpfehlung

LED E27 7W 280°
2200-2700K 830lm EEK=A++
7kWh/1000h
Art. Nr. 1002126



LED E27 9,1W 240°
2700K 760lm EEK=A+
10kWh/1000h
Art. Nr. 560402



Leuchtmittelangaben

max. 60W
Ø: 7 cm max. L: 16 cm max.

Variante	Art. Nr.
E27	
<input type="checkbox"/> matt aluminium	155236

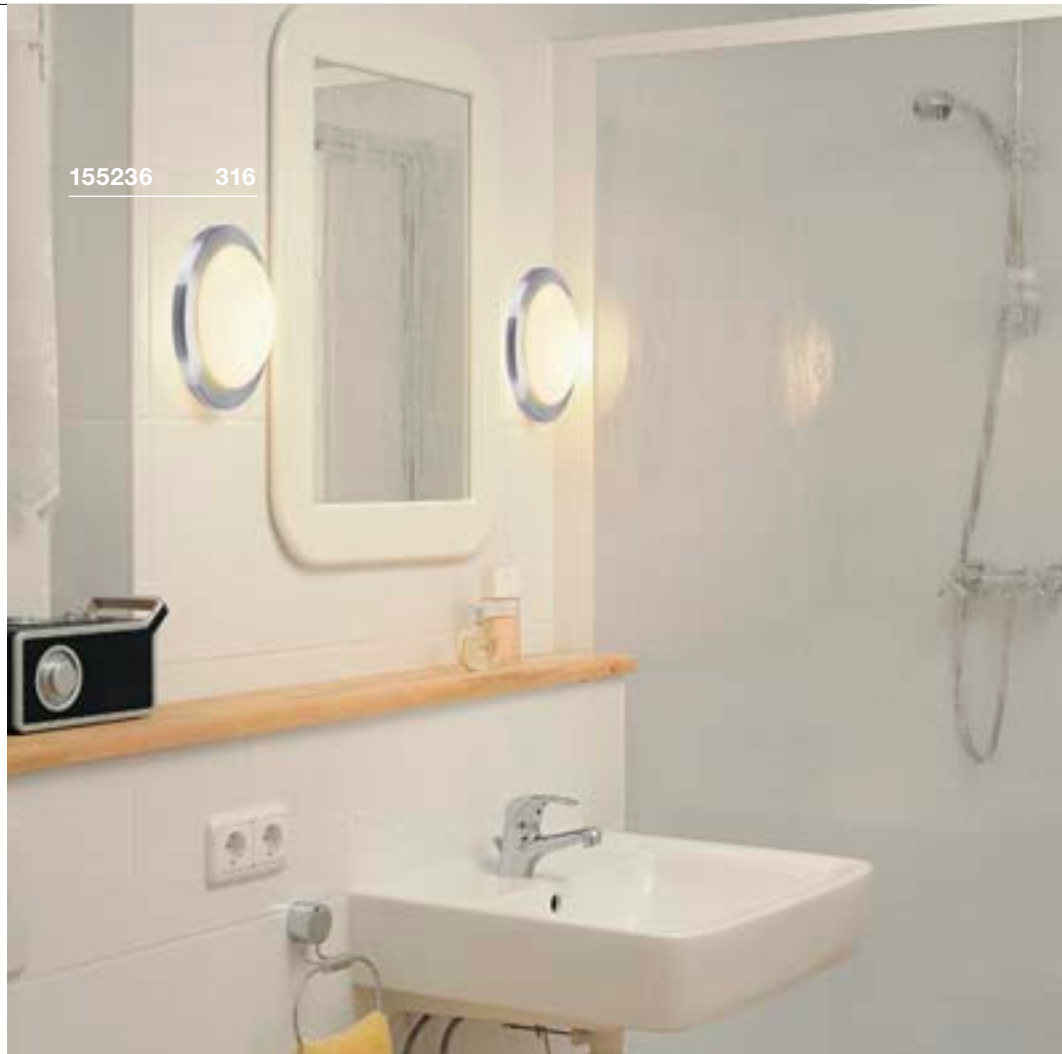



155180 317

GLASSA
CW, square, E27

E-A++ Spektrum A++-E



Produktangaben

230V ~50Hz
Material: satiniertes Glas/Stahl

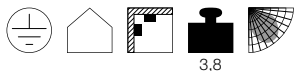

3,8

Maßzeichnung

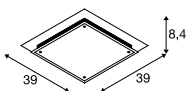

Leuchtmittlempfehlung

LED E27 7W 280°
2700K 790lm EEK=A++
7kWh/1000h
Art. Nr. 1002124



LED E27 8,5W
2700K 806lm EEK=A+
10kWh/1000h
Art. Nr. 560161



Leuchtmittelangaben

2x max. 60W
Ø: 4,8 cm max. L: 14,8 cm max.

Variante	Art. Nr.
E27	
■ matt transparent / chrom	155180

GLASSA
CW, round, E27

E-A++ Spektrum A++-E

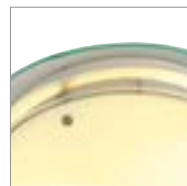
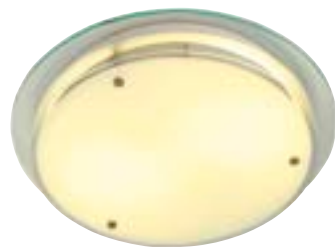

Produktangaben

230V ~50Hz
Material: Stahl/Glas



3,5

Maßzeichnung

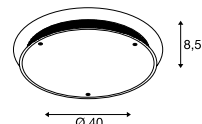

Leuchtmittlempfehlung

LED E27 7W 280°
2700K 790lm EEK=A++
7kWh/1000h
Art. Nr. 1002124



LED E27 8,5W
2700K 806lm EEK=A+
10kWh/1000h
Art. Nr. 560161



Leuchtmittelangaben

2x max. 60W
Ø: 4,8 cm max. L: 13,6 cm max.

Variante	Art. Nr.
E27	
■ matt transparent / chrom	155185

SIMA
CW, round, TRIAC

A-A++ Spektrum
A+-E



- Flache, robuste Bauform
- Mit Abstandhalter zur Kabelaufputzmontage

Produktangaben

220-240V ~50/60Hz | 350mA
Systemleistung: 25W
Material: Polycarbonat (PC)
Dimmbar: Triac C, Triac L

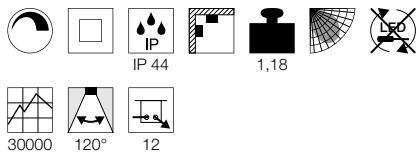

Maßzeichnung

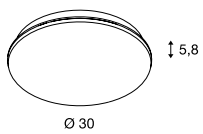

163020 318

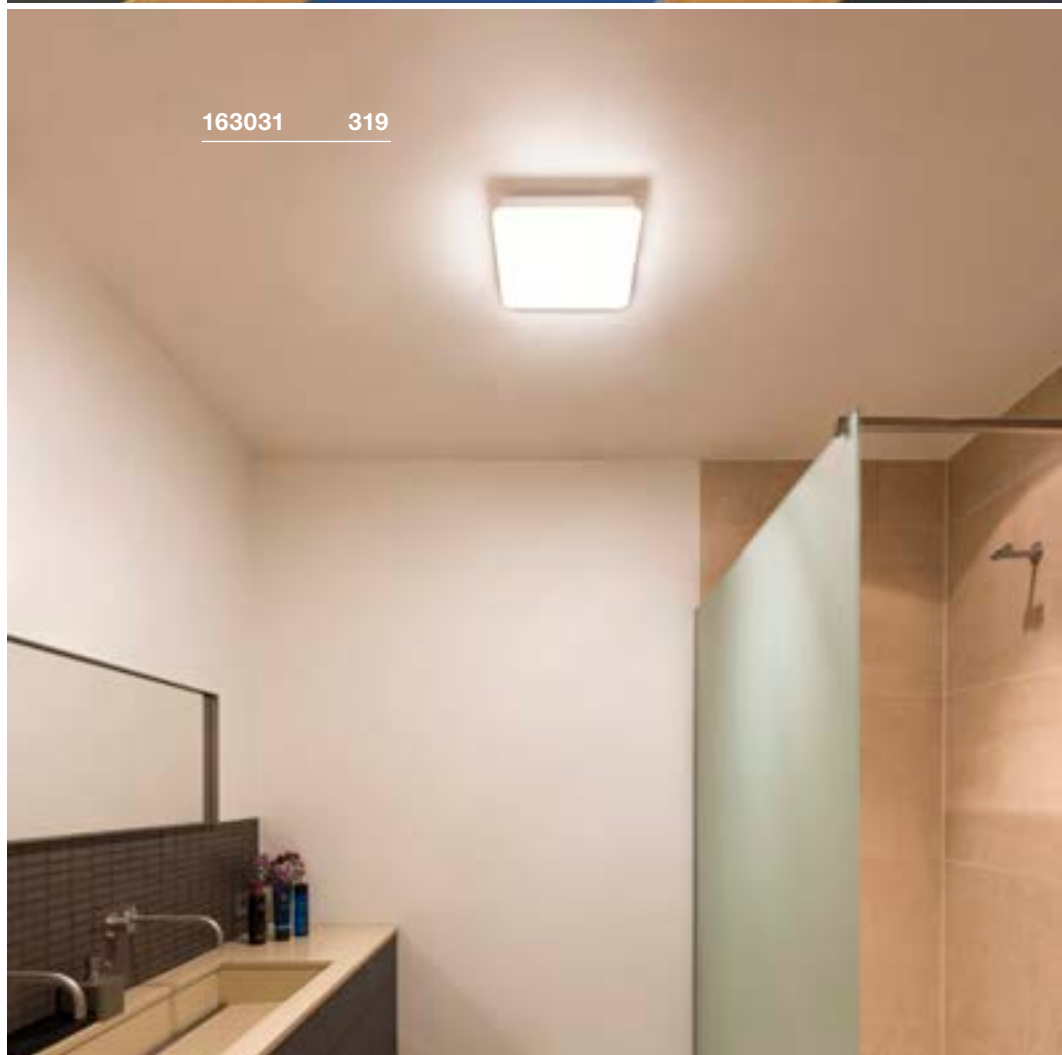

163031 319

Variante	Art. Nr.
2300lm 3000K CRI>80 □ weiß	163020

SIMA
CW, round, Sensor

A-A++ Spektrum A++-E



- Flache, robuste Bauform
- Mit Abstandhalter zur Kabelaufputzmontage
- Bewegungsmelder mit MR (Microwellen-) Technik im Leuchtengehäuse integriert

Produktangaben

220-240V ~50/60Hz | 350mA
Systemleistung: 27W
Material: Polycarbonat (PC)

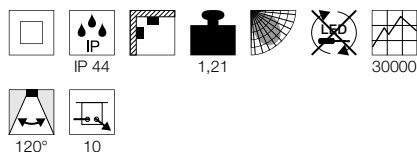

Maßzeichnung

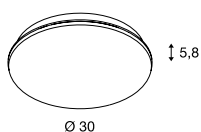

SIMA
CW, square, TRIAC

A-A++ Spektrum A++-E



- Flache, robuste Bauform
- Mit Abstandhalter zur Kabelaufputzmontage

Produktangaben

220-240V ~50/60Hz | 350mA
Systemleistung: 25W
Material: Polycarbonat (PC)
Dimmbar: Triac C, Triac L

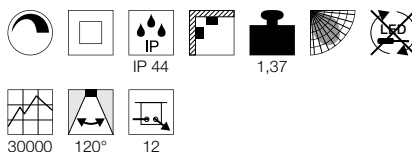

Maßzeichnung

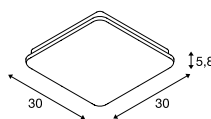

SIMA
CW, square, Sensor

A-A++ Spektrum A++-E

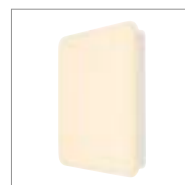

- Flache, robuste Bauform
- Mit Abstandhalter zur Kabelaufputzmontage
- Bewegungsmelder mit MR (Microwellen-) Technik im Leuchtengehäuse integriert

Produktangaben

220-240V ~50/60Hz | 350mA
Systemleistung: 27W
Material: Polycarbonat (PC)

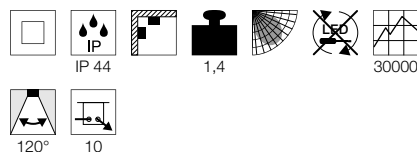

Maßzeichnung

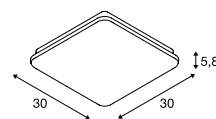

Variante	Art. Nr.
2300lm 3000K CRI>80	
□ weiß	163021

Variante	Art. Nr.
2300lm 3000K CRI>80	
□ weiß	163030

Variante	Art. Nr.
2300lm 3000K CRI>80	
□ weiß	163031

1001884 321



MEDO 30 CORONA
CW, TRIAC



A-A++ Spektrum A++-E



- Mit Corona Effekt
- Farbtemperatur (3000K/4000K) über Schalter einstellbar

Produktangaben

220-240V ~50/60Hz | 350mA
Systemleistung: 15W
Material: Aluminium / Polycarbonat (PC)
Dimmbar: Triac C

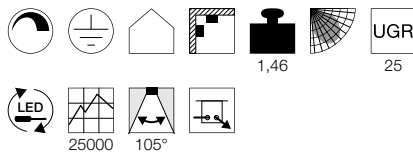

Maßzeichnung

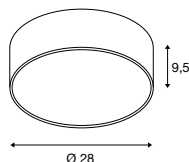

Hinweis

Abhängeset exkl.

Zubehörempfehlung

- Abhängeset 1,5m
Art. Nr. 135250
- Abhängeset 1,5m
Art. Nr. 135251
- Abhängeset 1,5m
Art. Nr. 135254
- Abhängeset 5m
Art. Nr. 1001950
- Abhängeset 5m
Art. Nr. 1001951
- Abhängeset 5m
Art. Nr. 1001952

Variante	Art. Nr.
Down: 1230/1280lm 3000/4000K CRI>80 Up: 20lm 3000/4000K CRI>80	
■ schwarz	1001877
Down: 1230/1280lm 3000/4000K CRI>80 Up: 20lm 3000/4000K CRI>80	
□ weiß	1001881
Down: 1230/1280lm 3000/4000K CRI>80 Up: 20lm 3000/4000K CRI>80	
■ grau	1001882

MEDO 40 CORONA
CW, TRIAC



A-A++ Spektrum A++-E

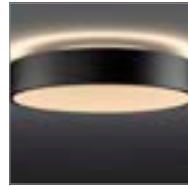

- Mit Corona Effekt
- Farbtemperatur (3000K/4000K) über Schalter einstellbar

Produktangaben

220-240V ~50/60Hz | 700mA
Systemleistung: 30W
Material: Aluminium / Polycarbonat (PC)
Dimmbar: Triac C

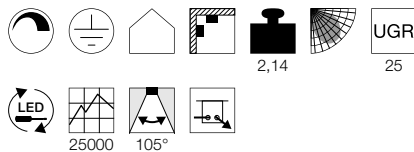

Maßzeichnung

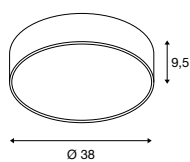

Hinweis

Abhängeset exkl.

Zubehörempfehlung

- Abhängeset 1,5m
Art. Nr. 135250
- Abhängeset 1,5m
Art. Nr. 135251
- Abhängeset 1,5m
Art. Nr. 135254
- Abhängeset 5m
Art. Nr. 1001950
- Abhängeset 5m
Art. Nr. 1001951
- Abhängeset 5m
Art. Nr. 1001952

Variante	Art. Nr.
Down: 2750/2900lm 3000/4000K CRI>80 Up: 50lm 3000/4000K CRI>80	
■ schwarz	1001883
Down: 2750/2900lm 3000/4000K CRI>80 Up: 50lm 3000/4000K CRI>80	
□ weiß	1001884
Down: 2750/2900lm 3000/4000K CRI>80 Up: 50lm 3000/4000K CRI>80	
■ grau	1001885

MEDO 60 CORONA
CW, TRIAC



A-A++ Spektrum A++-E

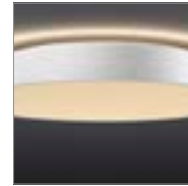

- Mit Corona Effekt
- Farbtemperatur (3000K/4000K) über Schalter einstellbar

Produktangaben

220-240V ~50/60Hz | 1050mA
Systemleistung: 40W
Material: Aluminium / Polycarbonat (PC)
Dimmbar: Triac C

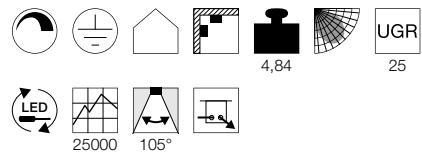

Maßzeichnung

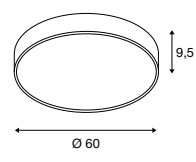

Hinweis

Abhängeset exkl.

Zubehörempfehlung

- Abhängeset 1,5m
Art. Nr. 135250
- Abhängeset 1,5m
Art. Nr. 135251
- Abhängeset 1,5m
Art. Nr. 135254
- Abhängeset 5m
Art. Nr. 1001950
- Abhängeset 5m
Art. Nr. 1001951
- Abhängeset 5m
Art. Nr. 1001952

Variante	Art. Nr.
Down: 4350/4750lm 3000/4000K CRI>80 Up: 120lm 3000/4000K CRI>80	
■ schwarz	1001886
Down: 4350/4750lm 3000/4000K CRI>80 Up: 120lm 3000/4000K CRI>80	
□ weiß	1001887
Down: 4350/4750lm 3000/4000K CRI>80 Up: 120lm 3000/4000K CRI>80	
■ grau	1001888

1002858 323



MALANG
CW, SLV VALETO®

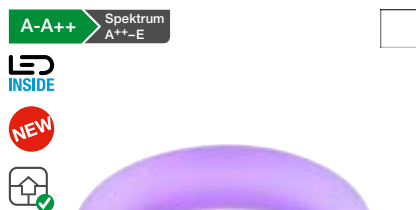

- Integrierbar in das SLV VALETO® System und andere ZigBee® Systeme
- Panel separat steuerbar von warm- bis kaltweiß und dimmbar
- Ring separat steuerbar in RGBW-Farben und dimmbar

Produktangaben

100-240V ~50/60Hz | 24V DC
Systemleistung: 39W
Material: Aluminium / Polycarbonat (PC)

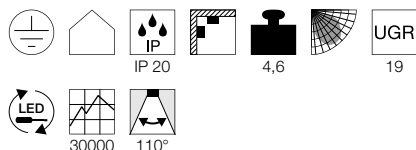

Maßzeichnung

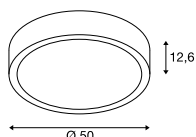

Hinweis

Fernsteuerbar und dimmbar mit SLV VALETO® CCT/RGBW Fernbedienung [1002994] oder Gateway [1002411]

Zubehöreffahrung

- Abhängeset 1,5m
Art. Nr. 135250
- Abhängeset 1,5m
Art. Nr. 135251
- Abhängeset 1,5m
Art. Nr. 135254
- Abhängeset 5m
Art. Nr. 1001950
- Abhängeset 5m
Art. Nr. 1001951
- Abhängeset 5m
Art. Nr. 1001952
- Fernbedienung CCT/RGBW
Art. Nr. 1002994

Variante	Art. Nr.
Ring: 350lm RGB+W (3000K) CRI>80 Panel: 2100-2400lm 2700-6500K CRI>80 □ weiß	1002858

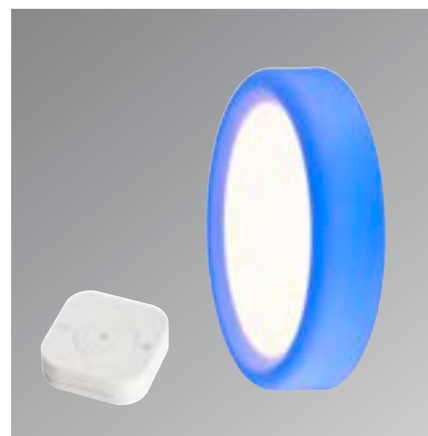

Der dekorative **RING** ist separat steuerbar. Schaffen Sie ein stimmungsvolles Ambiente, indem Sie verschiedene Lichtfarben einstellen und das Licht dimmen.

Das **PANEL** ist separat steuerbar. Sie können die Farbtemperatur von 2700-6500K einstellen und das Licht dimmen.



Mit unserem SLV VALETO® SMART LIGHT SYSTEM haben Sie die Wahl: Steuern Sie das Licht Zuhause mit unserer SLV VALETO® Fernbedienung (1002994), oder einer App auf Ihrem Smartphone über unser SLV VALETO® Gateway (1002411).

Dank des neuesten ZigBee Standards (ZigBee 3.0) sind Ihnen bei Ihrer smarten Lichtsteuerung keine Grenzen gesetzt.



Fernbedienung
Art. Nr. 1002994



Gateway
Art. Nr. 1002411



SLV VALETO®
App

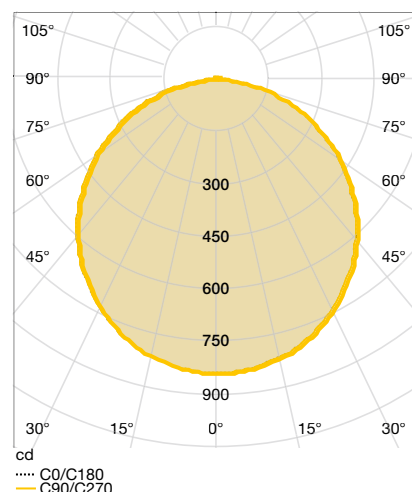
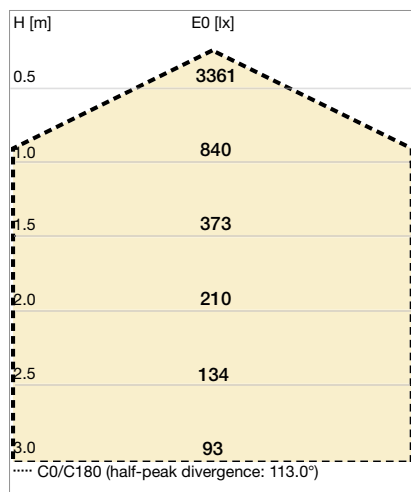

SENSER
CW, square, TRIAC



A-A++ Spektrum A++-E

Produktangaben

220-240V ~50/60Hz
Material: Aluminium
Dimmbar: Triac C

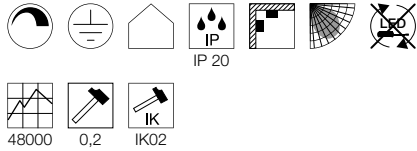

SENSER 12
CW, square, TRIAC



Maßzeichnung

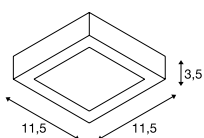

Variante	Art. Nr.
480lm 3000K CRI>80 8,2W 0,27 kg □ matt weiß	1003017

SENSER 18
CW, square, TRIAC



Maßzeichnung

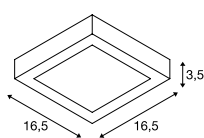

Variante	Art. Nr.
880lm 3000K CRI>80 12W 0,39 kg □ matt weiß	1003018

SENSER 24
CW, square, TRIAC



Maßzeichnung

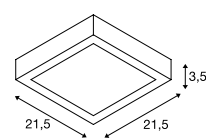

Variante	Art. Nr.
1200lm 3000K CRI>80 15W 0,5 kg □ matt weiß	1003019

SENSER
CW, round, TRIAC



A-A++ Spektrum
A++-E

Produktangaben

220-240V ~50/60Hz
Material: Aluminium
Dimmbar: Triac C

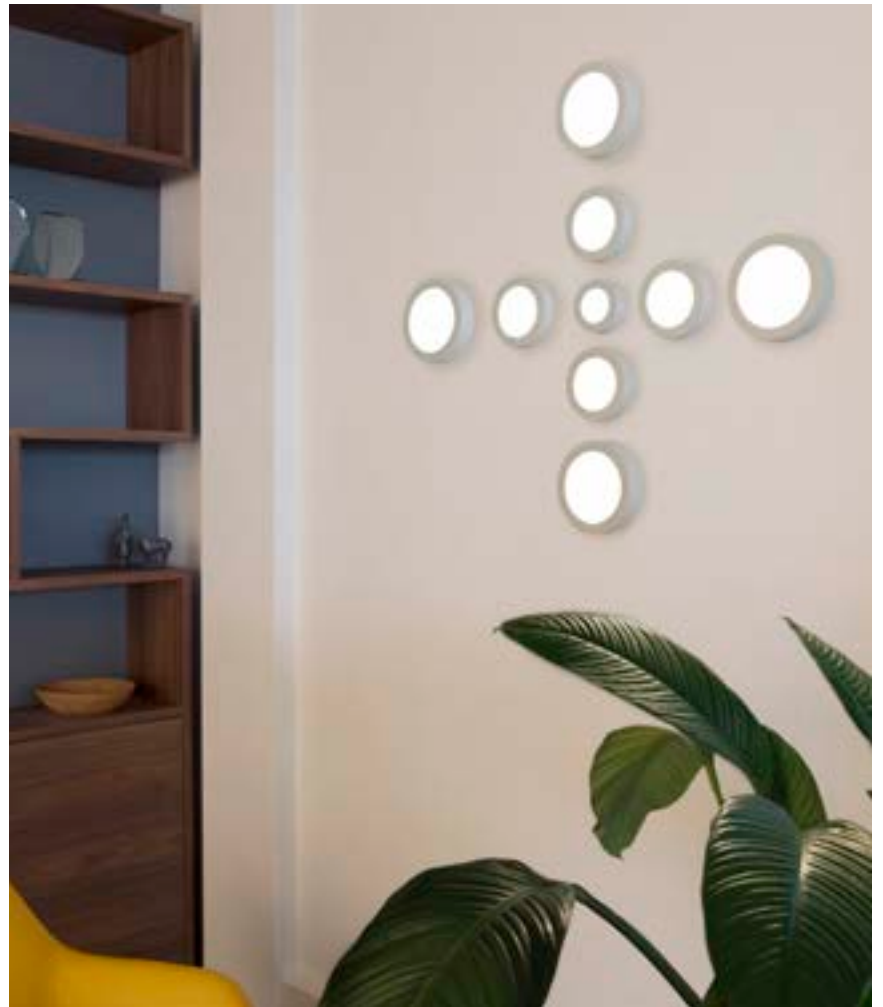
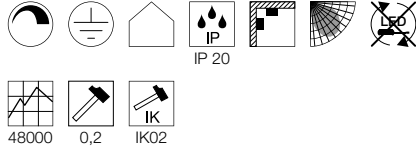

SENSER 12
CW, round, TRIAC



Maßzeichnung

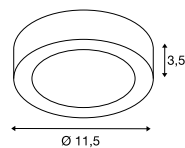

Variante	Art. Nr.
480lm 3000K CRI>80 8,2W 0,23 kg □ matt weiß	1003014

SENSER 18
CW, round, TRIAC



Maßzeichnung

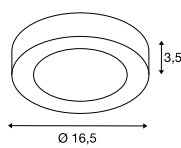

Variante	Art. Nr.
880lm 3000K CRI>80 12W 0,34 kg □ matt weiß	1003015

SENSER 24
CW, round, TRIAC



Maßzeichnung

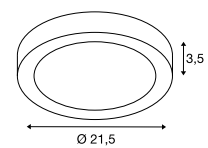

Variante	Art. Nr.
1200lm 3000K CRI>80 15W 0,47 kg □ matt weiß	1003016



BENA Video



bit.ly/slv-bena





BENA 120
CW

A-A++ Spektrum A++-E



• Einfache Installation

Produktangaben

220-240V ~50/60Hz | 700mA
Systemleistung: 28W
Material: Polymethylacrylat (PMMA) / Stahl

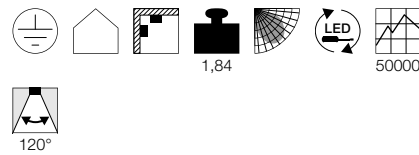

Maßzeichnung

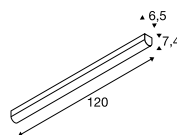

BENA 150
CW

A-A++ Spektrum A++-E

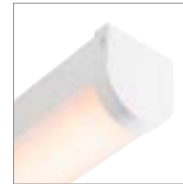

• Einfache Installation

Produktangaben

220-240V ~50/60Hz | 700mA
Systemleistung: 38W
Material: Polymethylacrylat (PMMA) / Stahl

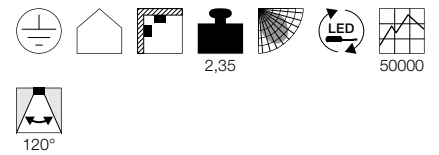

Maßzeichnung

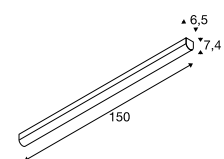

Variante	Art. Nr.
3200lm 3000K CRI>80 □ weiß	631337
3400lm 4000K CRI>80 □ weiß	631347

Variante	Art. Nr.
4400lm 3000K CRI>80 □ weiß	631339
4600lm 4000K CRI>80 □ weiß	631349

SIGHT 60
CW



A-A++ Spektrum
A++-E

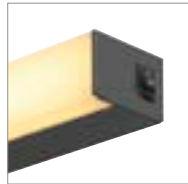

• Schalter am Leuchtengehäuse

Produktangaben

220-240V ~50/60Hz | 700mA
Systemleistung: 20W
Material: Aluminium / Acryl

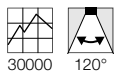
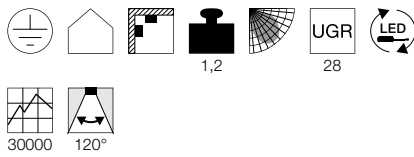

Maßzeichnung

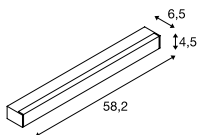

SIGHT 115
CW



A-A++ Spektrum
A++-E

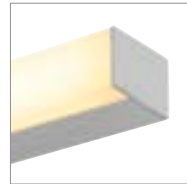

Produktangaben

220-240V ~50/60Hz | 700mA
Systemleistung: 37,3W
Material: Aluminium / Acryl

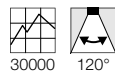
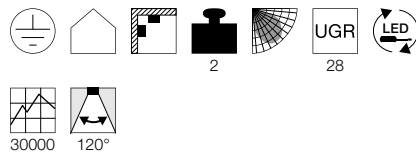

Maßzeichnung

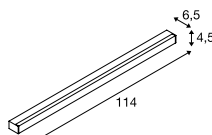

1001286 328



Variante	Art. Nr.
1490lm 3000K CRI>80 ■ schwarz	1001283
1490lm 3000K CRI>80 □ weiß	1001284
1490lm 3000K CRI>80 ■ grau	1001285

Variante	Art. Nr.
3100lm 3000K CRI>80 ■ schwarz	1001286
3100lm 3000K CRI>80 □ weiß	1001287
3100lm 3000K CRI>80 ■ grau	1001288

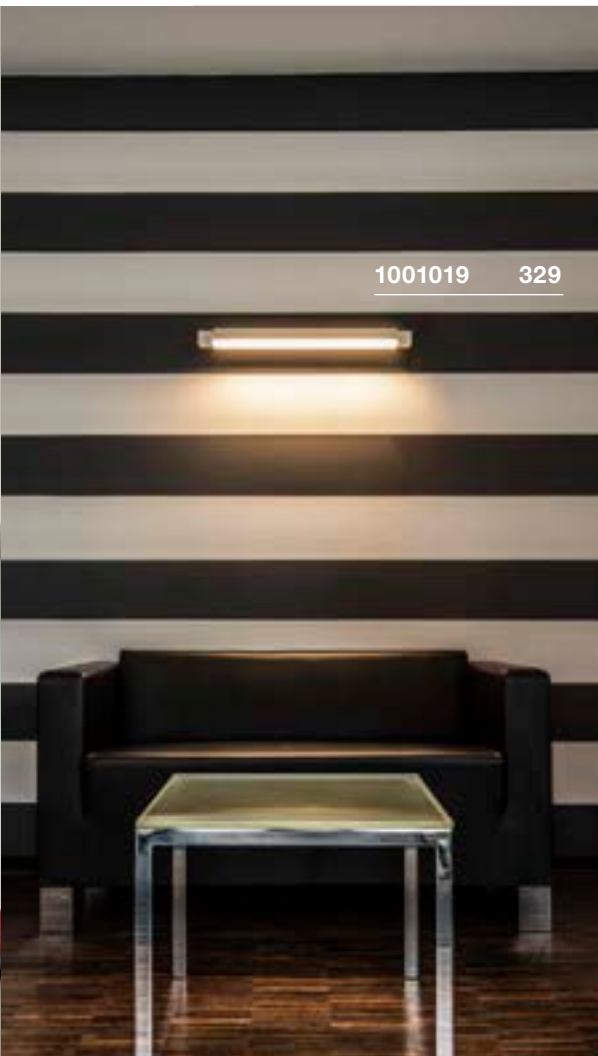

1001019 329



157660 329

LONG GRILL CW

A-A++ Spektrum A++-E

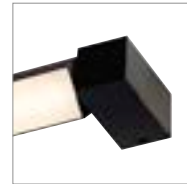

• Leuchteneinheit 270° schwenkbar

Produktangaben

220-240V ~50/60Hz | 700mA
Systemleistung: 20W
Material: Aluminium / Acryl

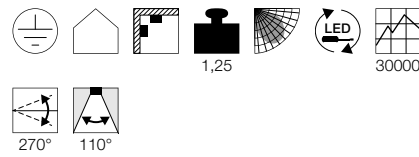

Maßzeichnung

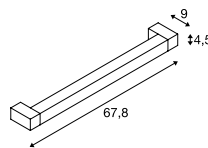

OPEN GRILL CW

892

A-A++ Spektrum A++-E



• Leuchteneinheit 270° schwenkbar

Produktangaben

220-240V ~50/60Hz | 1050mA
Systemleistung: 54W
Material: Aluminium / Acryl

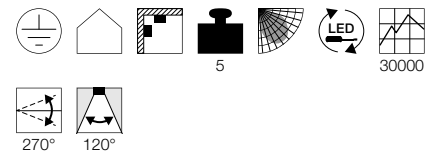

Maßzeichnung

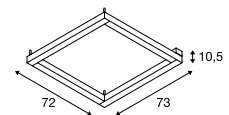

Variante	Art. Nr.
1600lm 3000K CRI>80 ■ schwarz	1001020
1600lm 3000K CRI>80 □ weiß	1001019

Variante	Art. Nr.
4500lm 3000K CRI>80 ■ schwarz	1001293
4500lm 3000K CRI>80 □ weiß	1001294

PROFESSIONELL AUFGESTELLT.

3-PHASEN-HOCHVOLT-STROMSCHIENEN FÜR NEUE LICHTAKZENTE.

Besonders dort, wo es viel zu sehen gibt, ist eine gut durchdachte Beleuchtung unerlässlich. 3-Phasen-Hochvolt-Stromschienen sind darum besonders für Shops und Messestände ideal. Sie ermöglichen eine perfekte Ausleuchtung und rücken Produkte und Ausstellungsstücke ins rechte Licht.

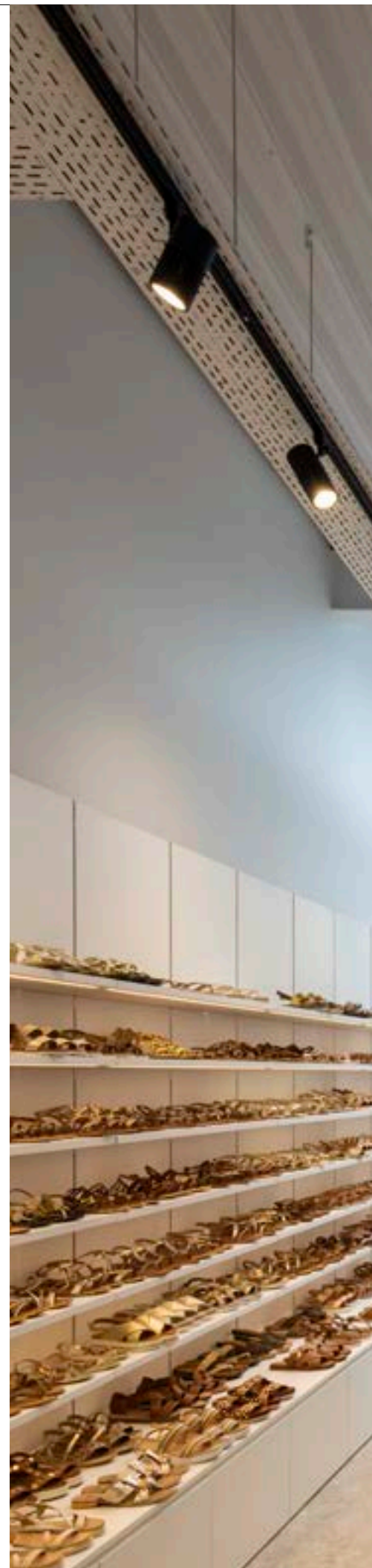

1003026 336





176081 356





1001269 348

HOCHVOLT-STROMSCHIENE 3PHASEN

 334	 334	 335	 336	 337	 342	 343	 343
 344	 344	 345	 345	 346	 346	 346	 348
 349	 349	 350	 351	 351	 351	 352	 352
 353	 353	 354	 355	 355	 356	 356	 356
 357	 358	 358	 359	 359	 360	 360	 361
 361	 361	 362	 363	 363	 363		

Passende Einbau- und Aufbauschielen sowie Zubehör finden Sie auf den Seiten 339-341, 365-373

 Weitere Leuchten und Varianten finden Sie online unter www.slv.com

EURO SPOT TRACK
3Ph., DALI, 235mm



A-A++ Spektrum A++-E



NEW VARIANT



- Premium LED mit CRI>90

Produktangaben

220-240V ~50/60Hz | 1000mA
Systemleistung: 42W
Material: Aluminium
Dimmbar: Dali

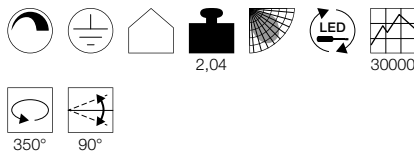

Maßzeichnung

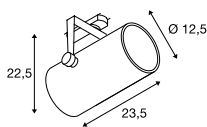

Variante	Art. Nr.
2900lm 3000K CRI 15°	
■ schwarz	1002809
2900lm 3000K CRI 15°	
□ weiß	1002810
3200lm 4000K CRI 15°	
■ schwarz	1002811
3200lm 4000K CRI 15°	
□ weiß	1002812
2900lm 3000K CRI 38°	
■ schwarz	1002813
2900lm 3000K CRI 38°	
□ weiß	1002814
3200lm 4000K CRI 38°	
■ schwarz	1002815
3200lm 4000K CRI 38°	
□ weiß	1002816
2850lm 3000K CRI 60°	
■ schwarz	1002817
2850lm 3000K CRI 60°	
□ weiß	1002818
3150lm 4000K CRI 60°	
■ schwarz	1002819
3150lm 4000K CRI 60°	
□ weiß	1002820

EURO SPOT TRACK
3Ph., DALI, 255mm



A-A++ Spektrum A++-E



NEW VARIANT



- Premium LED mit CRI>90

Produktangaben

220-240V ~50/60Hz | 1200mA
Systemleistung: 47W
Material: Aluminium
Dimmbar: Dali

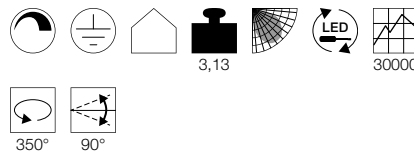

Maßzeichnung

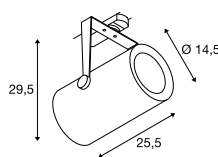

Variante	Art. Nr.
4800lm 3000K CRI>90 40°	
■ schwarz	1002663
4800lm 3000K CRI>90 40°	
□ weiß	1002664
4800lm 4000K CRI>90 40°	
■ schwarz	1002665
4800lm 4000K CRI>90 40°	
□ weiß	1002666





1002667 335

EURO SPOT TRACK
3Ph., DALI, 173mm

886

A-A++ Spektrum
A++-E



- Premium LED mit CRI>90

Produktangaben

220-240V ~50/60Hz | 500mA
 Systemleistung: 20W
 Material: Aluminium
 Dimmbar: Dali

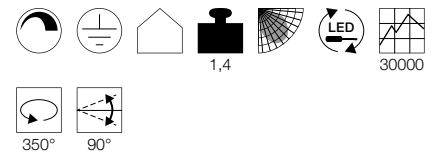
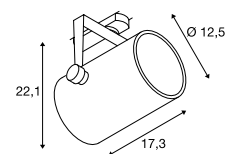
Maßzeichnung

Variante	Art. Nr.
1900lm 3000K CRI>90 15°	
■ schwarz	1002667
1900lm 3000K CRI>90 15°	
□ weiß	1002668
1900lm 3000K CRI>90 38°	
■ schwarz	1002669
1900lm 3000K CRI>90 38°	
□ weiß	1002670
1900lm 3000K CRI>90 60°	
■ schwarz	1002671
1900lm 3000K CRI>90 60°	
□ weiß	1002672
2000lm 4000K CRI>90 15°	
■ schwarz	1002673
2000lm 4000K CRI>90 15°	
□ weiß	1002674
2000lm 4000K CRI>90 38°	
■ schwarz	1002675
2000lm 4000K CRI>90 38°	
□ weiß	1002676
2000lm 4000K CRI>90 60°	
■ schwarz	1002677
2000lm 4000K CRI>90 60°	
□ weiß	1002678

STRUCTEC
3Ph., DALI



1003025 336

A-A++ Spektrum A++-E

LED INSIDE

NEW VARIANT



- Premium LED mit CRI>90

Produktangaben

200-240V ~50/60Hz | 700mA
Systemleistung: 29W
Material: Aluminium
Dimmbar: Dali

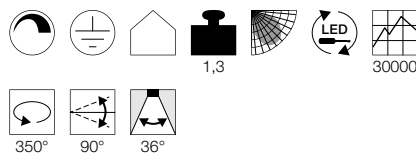

Maßzeichnung

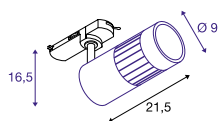

Variante	Art. Nr.
2500lm 3000K CRI97	
■ matt schwarz	1003024
2500lm 3000K CRI97	
□ matt weiß	1003025
2600lm 4000K CRI97	
■ matt schwarz	1003026
2600lm 4000K CRI97	
□ matt weiß	1003027

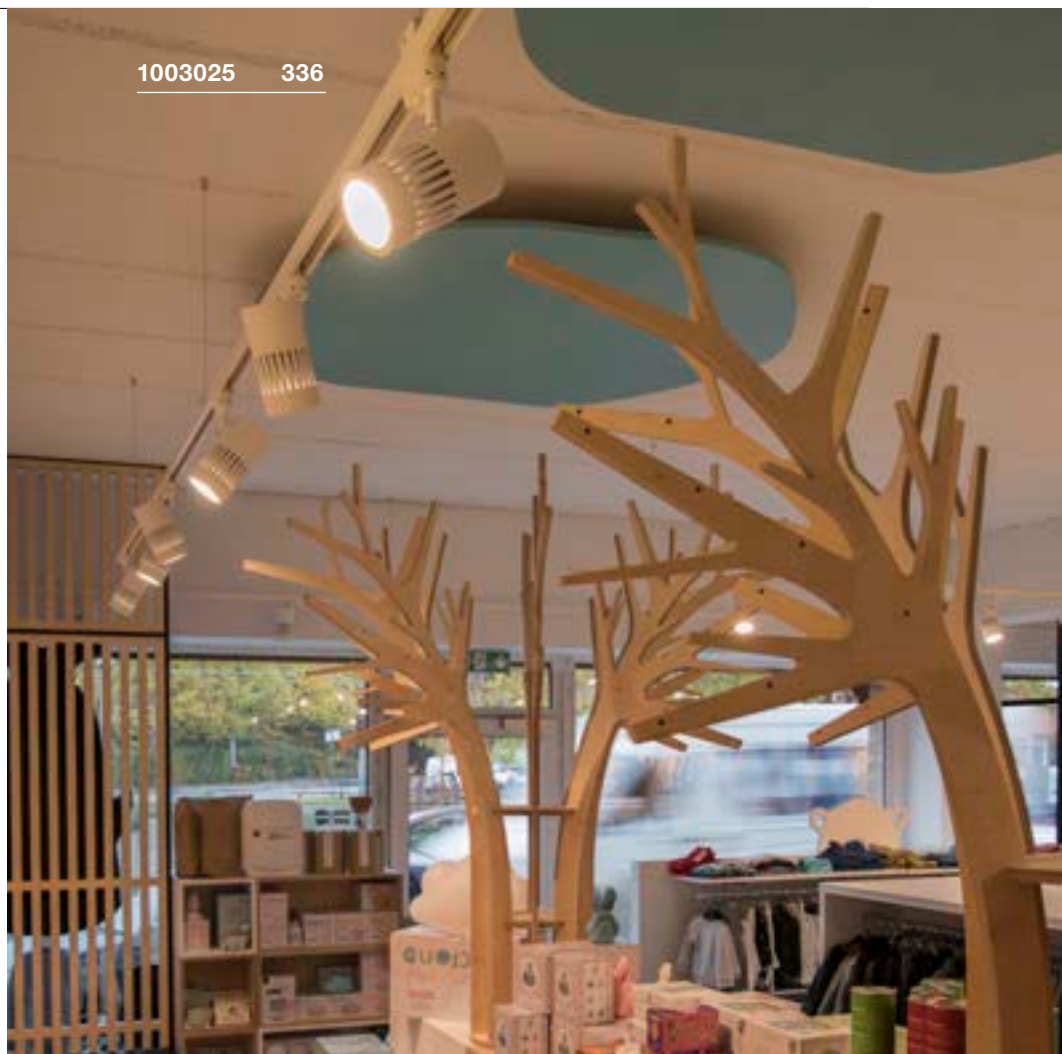



1002661 337

SIGHT TRACK
3Ph., DALI
 895

A-A++

Spektrum
A++-ENEW
VARIANT

Produktangaben

220-240V 0/~50/60Hz | 700mA
Systemleistung: 40W
Material: Aluminium / Acryl
Dimmbar: Dali

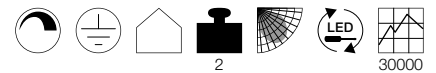

2



30000

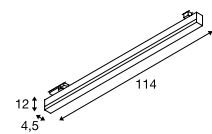

120°

Maßzeichnung



Variante	Art. Nr.
3100lm 3000K CRI>80	
■ schwarz	1002661 
3100lm 3000K CRI>80	
□ weiß	1002662 



1002667 335



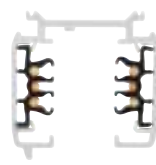

S-TRACK 3PHASEN-AUFBAUSCHIENE DALI



S-TRACK
3Phasen Aufbauschiene, DALI, 2m



S-TRACK
3Phasen Aufbauschiene, DALI, 2m

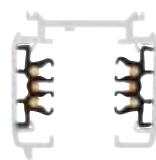

		
Bemessungsspannung	220-250V ~50/60Hz	220-250V ~50/60Hz
Strombelastung max.	16A	16A
mech. Belastung max.	300N	300N
mech. Belastung max.	30 kg	30 kg
Einspeisemöglichkeit	nein	nein
Material	Aluminium	Aluminium
Farbe	schwarz	weiß
Länge	200 cm	200 cm
Breite	3,6 cm	3,6 cm
Höhe	3,6 cm	3,6 cm
Gewicht	1,84 kg	1,84 kg
Art. Nr.	1002631	1002632



S-TRACK
3Phasen Aufbauschiene, DALI, 3m



S-TRACK
3Phasen Aufbauschiene, DALI, 3m

		
Bemessungsspannung	220-250V ~50/60Hz	220-250V ~50/60Hz
Strombelastung max.	16A	16A
mech. Belastung max.	300N	300N
mech. Belastung max.	30 kg	30 kg
Einspeisemöglichkeit	nein	nein
Material	Aluminium	Aluminium
Farbe	schwarz	weiß
Länge	300 cm	300 cm
Breite	3,6 cm	3,6 cm
Höhe	3,6 cm	3,6 cm
Gewicht	2,76 kg	2,76 kg
Art. Nr.	1002633	1002634



1001002 356

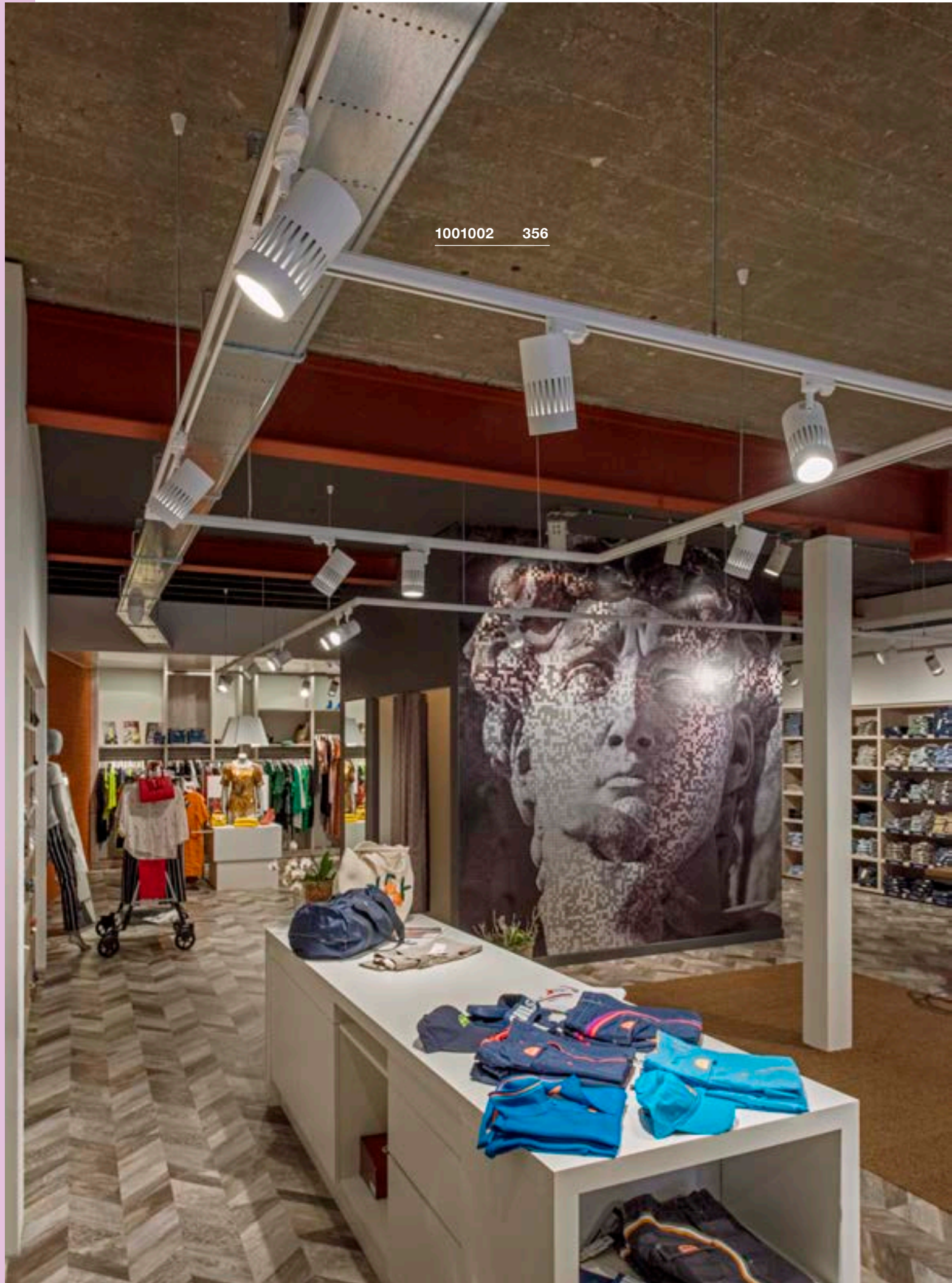

ZUBEHÖR S-TRACK 3PHASEN-AUFBAUSCHIENE DALI

Einspeiser, DALI, Erde links

16A max.
Polycarbonat (PC)
L: 13,9 cm B: 3,5 cm H: 3,3 cm
Gewicht: 0,06 kg
1 Stk.



Variante	Art. Nr.
<input checked="" type="checkbox"/> schwarz	1002638
<input type="checkbox"/> weiß	1002640

L-Verbinder, DALI, Erde außen

16A max.
Polycarbonat (PC)
L: 11,9 cm B: 11,9 cm H: 3,3 cm
Gewicht: 0,13 kg
1 Stk.



Variante	Art. Nr.
<input checked="" type="checkbox"/> schwarz	1002648
<input type="checkbox"/> weiß	1002650

Deckenabhangung

Edelstahl / Messing
L: 500 cm
Gewicht: 0,2 kg
Max. 10 kg
2 Stk.



Variante	Art. Nr.
<input type="checkbox"/> nickel	1002845

Einspeiser, DALI, Erde rechts

10A max.
Polycarbonat (PC)
L: 13,9 cm B: 3,5 cm H: 3,3 cm
Gewicht: 0,06 kg
1 Stk.



Variante	Art. Nr.
<input checked="" type="checkbox"/> schwarz	1002637
<input type="checkbox"/> weiß	1002639

T-Verbinder, DALI, Erde rechts

16A max.
Polycarbonat (PC)
L: 20,3 cm B: 11,9 cm H: 3,3 cm
Gewicht: 0,2 kg
1 Stk.



Variante	Art. Nr.
<input checked="" type="checkbox"/> schwarz	1002651
<input type="checkbox"/> weiß	1002653

3Ph-Adapter mit Haken

Kunststoff / Stahl
Ø: 2,6 cm H: 5,2 cm
Gewicht: 0,01 kg
Max. 10 kg
1 Stk.



Variante	Art. Nr.
<input checked="" type="checkbox"/> schwarz	175190
<input type="checkbox"/> weiß	1001393

Mini-Verbinder, DALI

16A max.
Polycarbonat (PC)
L: 10,6 cm B: 2,5 cm H: 2,8 cm
Gewicht: 0,04 kg
1 Stk.



Variante	Art. Nr.
<input checked="" type="checkbox"/> schwarz	1002641
<input type="checkbox"/> weiß	1002642

T-Verbinder, DALI, Erde links

16A max.
Polycarbonat (PC)
L: 20,3 cm B: 11,9 cm H: 3,3 cm
Gewicht: 0,2 kg
1 Stk.



Variante	Art. Nr.
<input checked="" type="checkbox"/> schwarz	1002652
<input type="checkbox"/> weiß	1002654

Drahtseilabhangung-Set mit Stange

Aluminium / Kunststoff
L: 100 cm B: 6 cm H: 4 cm
Gewicht: 0,2 kg
Max. 10 kg
1 Stk.



Variante	Art. Nr.
<input checked="" type="checkbox"/> schwarz	175160
<input type="checkbox"/> weiß	1001390

Längsverbinder, DALI

10A max.
Polycarbonat (PC)
L: 20,3 cm B: 3,5 cm H: 3,3 cm
Gewicht: 0,13 kg
1 Stk.



Variante	Art. Nr.
<input checked="" type="checkbox"/> schwarz	1002643
<input type="checkbox"/> weiß	1002644

X-Verbinder, DALI

16A max.
Polycarbonat (PC)
L: 20,3 cm B: 20,3 cm H: 3,3 cm
Gewicht: 0,27 kg
1 Stk.



Variante	Art. Nr.
<input checked="" type="checkbox"/> schwarz	1002655
<input type="checkbox"/> weiß	1002656

Endkappe

Kunststoff
L: 3,5 cm B: 3,3 cm H: 3,2 cm
Gewicht: 0,01 kg
1 Stk.



Variante	Art. Nr.
<input checked="" type="checkbox"/> schwarz	175060
<input type="checkbox"/> weiß	1001380

Flexverbinder, DALI

16A max.
Polycarbonat (PC)
L: 28,5 cm B: 3,5 cm H: 3,3 cm
Gewicht: 0,18 kg
1 Stk.



Variante	Art. Nr.
<input checked="" type="checkbox"/> schwarz	1002645
<input type="checkbox"/> weiß	1002646

Befestigungsklammer, DALI

Stahl
L: 4 cm B: 3,4 cm H: 1,25 cm
Gewicht: 0,02 kg
1 Stk.



Variante	Art. Nr.
<input checked="" type="checkbox"/> schwarz	1002657
<input type="checkbox"/> weiß	1002658

L-Verbinder, DALI, Erde innen

16A max.
Polycarbonat (PC)
L: 11,9 cm B: 11,9 cm H: 3,3 cm
Gewicht: 0,13 kg
1 Stk.



Variante	Art. Nr.
<input checked="" type="checkbox"/> schwarz	1002647
<input type="checkbox"/> weiß	1002649

Adapter, DALI

10A max.
Polycarbonat (PC)
L: 11,3 cm B: 5,5 cm H: 3,3 cm
Gewicht: 0,062 kg
Max. 5 kg
1 Stk.



Variante	Art. Nr.
<input checked="" type="checkbox"/> schwarz	1002660
<input type="checkbox"/> weiß	1002659

SPOT TRACK
3Ph., E27



D-A+ Spektrum A++-E



- Stabiles Gelenk

Produktangaben

230V ~50Hz
Material: Aluminium

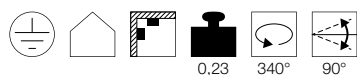

0,23 340° 90°

Maßzeichnung

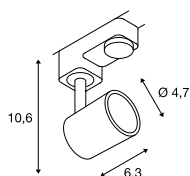

Leuchtmittlempfehlung

LED E27 11,5W 38°
3000K 760lm EEK=A+
12kWh/1000h

Art. Nr. 551933



LED E27 17W 45°
3000K 1430lm EEK=A+
17kWh/1000h

Art. Nr. 560473



Leuchtmittelangaben

max. 75W QPAR20
optional: QPAR30

Variante	Art. Nr.
E27 QPAR20	
■ schwarz	152200
E27 QPAR20	
□ weiß	152201
E27 QPAR20	
■ grau	152204



152201 342



152640 343



152640 343

AVO TRACK
3Ph., QPAR51



E-A++ Spektrum A++-E

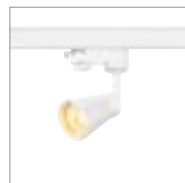

Produktangaben

230V ~50/60Hz
Material: Stahl

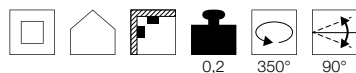

Maßzeichnung

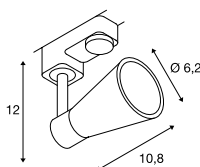

Leuchtmittlempfehlung

LED GU10 7,2W 36°
3000K 520lm EEK=A+
8kWh/1000h
Art. Nr. 1001563



LED GU10 5,5W 38°
2700K 400lm EEK=A+
6kWh/1000h
Art. Nr. 1001030



Leuchtmittelangaben

max. 50W QPAR51
Ø: 5 cm max.

Variante	Art. Nr.
GU10 QPAR51	
■ schwarz	152640
□ weiß	152641
■ grau	152644

ALTRA DICE TRACK
3Ph., QPAR51



E-A++ Spektrum A++-E



Produktangaben

220-240V ~50/60Hz
Material: Aluminium

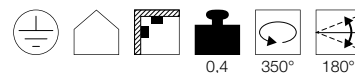

Maßzeichnung

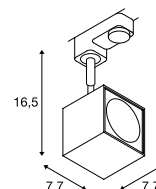

Leuchtmittlempfehlung

LED GU10 7,2W 36°
3000K 520lm EEK=A+
8kWh/1000h
Art. Nr. 1001563



LED GU10 5,5W 38°
2700K 400lm EEK=A+
6kWh/1000h
Art. Nr. 1001030



Leuchtmittelangaben

max. 50W QPAR51
Ø: 5 cm max. L: 5,7 cm max.

Variante	Art. Nr.
GU10 QPAR51	
■ schwarz	152320
□ weiß	152321
■ grau	152324

LIGHT EYE® 150
TRACK
3Ph., QPAR51



E-A++ Spektrum A++-E

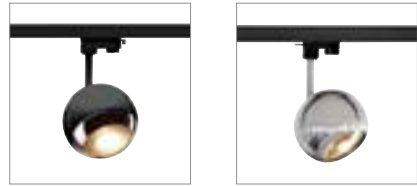

- Leuchteinheit 350° dreh-, und 90° schwenkbar

Produktangaben

230V ~50Hz
Material: Stahl

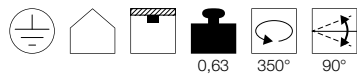

Maßzeichnung

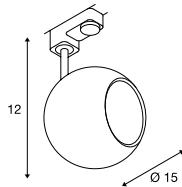

Leuchtmittlempfehlung

GU10 7W 25°
3000K 620lm EEK=A+
8kWh/1000h
Art. Nr. 1001570



LED GU10 7,9W 40°
4000K 760lm EEK=A+
8kWh/1000h
Art. Nr. 560724



Leuchtmittelangaben

max. 75W QPAR111

Variante	Art. Nr.
GU10 QPAR111	
■ schwarz	1000707
■ GU10 QPAR111	
■ weiß / chrom	1000708
■ GU10 QPAR111	
■ chrom	153102

PARA CONE 14
3Ph., QPAR51



E-A++ Spektrum A++-E

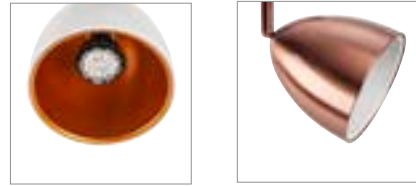

Produktangaben

220-240V ~50/60Hz
Material: Stahl
Produktmaße: Ø: 13,5 cm H: 22,50 cm



Maßzeichnung

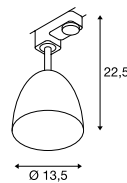

Leuchtmittelangaben

max. 25W QPAR51

Variante	Art. Nr.
GU10 QPAR111	
■ glänzend schwarz	1002876
■ GU10 QPAR111	
□ glänzend weiß	1002877
■ GU10 QPAR111	
■ kupfer	1002878

1000708 344



1002878 344





1001471 345



1001475 345

LENITO TRACK
3Ph.



A-A++ Spektrum A++-E



- Hohe Effizienz
- Breite, homogene Ausleuchtung

Produktangaben

220-240V ~50/60Hz | 160mA
Systemleistung: 23W
Material: Aluminium / Polycarbonat (PC)

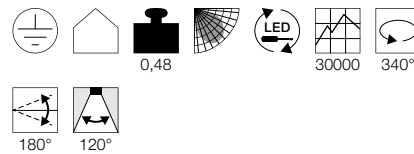

Maßzeichnung

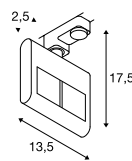

Variante	Art. Nr.
2500lm 3000K CRI>80 □ weiß	1001466
2450lm 3000K CRI>80 ■ schwarz	1001467

MERADO FLOOD TRACK
3Ph., TRIAC



A-A++ Spektrum A++-E



- Asymmetrische Lichtverteilung
- Zur gleichmäßigen Ausleuchtung

Produktangaben

220-240V ~50/60Hz | 1000mA
Systemleistung: 40W
Material: Aluminium / Kunststoff
Dimmbar: Triac C, Triac L

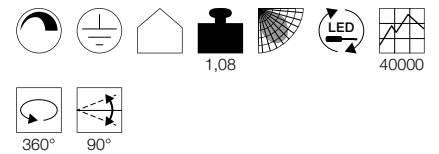

Maßzeichnung

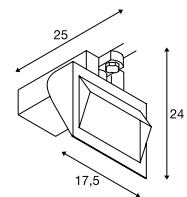

Variante	Art. Nr.
3000lm 3000K CRI>80 □ weiß	1001470
3000lm 3000K CRI>80 ■ schwarz	1001471
3200lm 4000K CRI>80 □ weiß	1001474
3200lm 4000K CRI>80 ■ schwarz	1001475

HELIA 50 TRACK
3Ph.

888

A-A++ Spektrum A++-E



• Premium LED mit CRI>90

Produktangaben

220-240V ~50/60Hz | 500mA
Systemleistung: 11W
Material: Aluminium

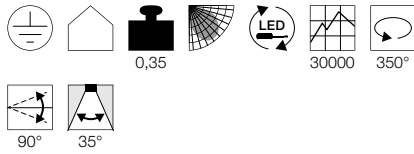

Maßzeichnung

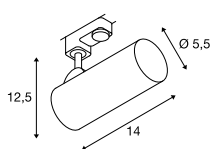

NOBLO SPOT
3Ph.

892

A-A++ Spektrum A++-E



Produktangaben

220-240V ~50/60Hz | 350mA
Systemleistung: 7,5W
Material: Aluminium

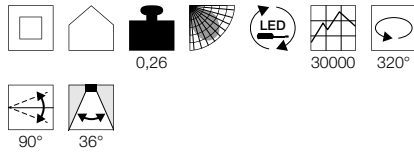

Maßzeichnung

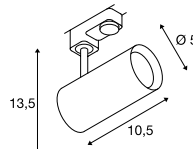

ENOLA C TRACK
3Ph.

886

A-A++ Spektrum A++-E



Produktangaben

220-240V ~50/60Hz | 500mA
Systemleistung: 12W
Material: Aluminium

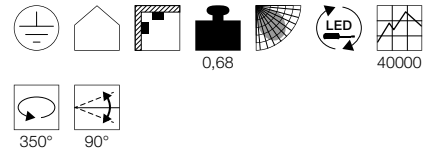

Maßzeichnung

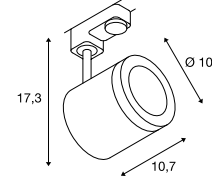

Variante	Art. Nr.
750lm 3000K CRI>90	
■ schwarz	152960
750lm 3000K CRI>90	
□ weiß	152961

Variante	Art. Nr.
620lm 2700K CRI>80	
■ schwarz	1001865
620lm 2700K CRI>80	
□ weiß	1001866
620lm 2700K CRI>80	
■ grau	1001867

Variante	Art. Nr.
900lm 3000K CRI>80 35°	
■ schwarz	152420
900lm 3000K CRI>80 35°	
□ weiß	152421
900lm 3000K CRI>80 55°	
■ schwarz	152430
900lm 3000K CRI>80 55°	
□ weiß	152431

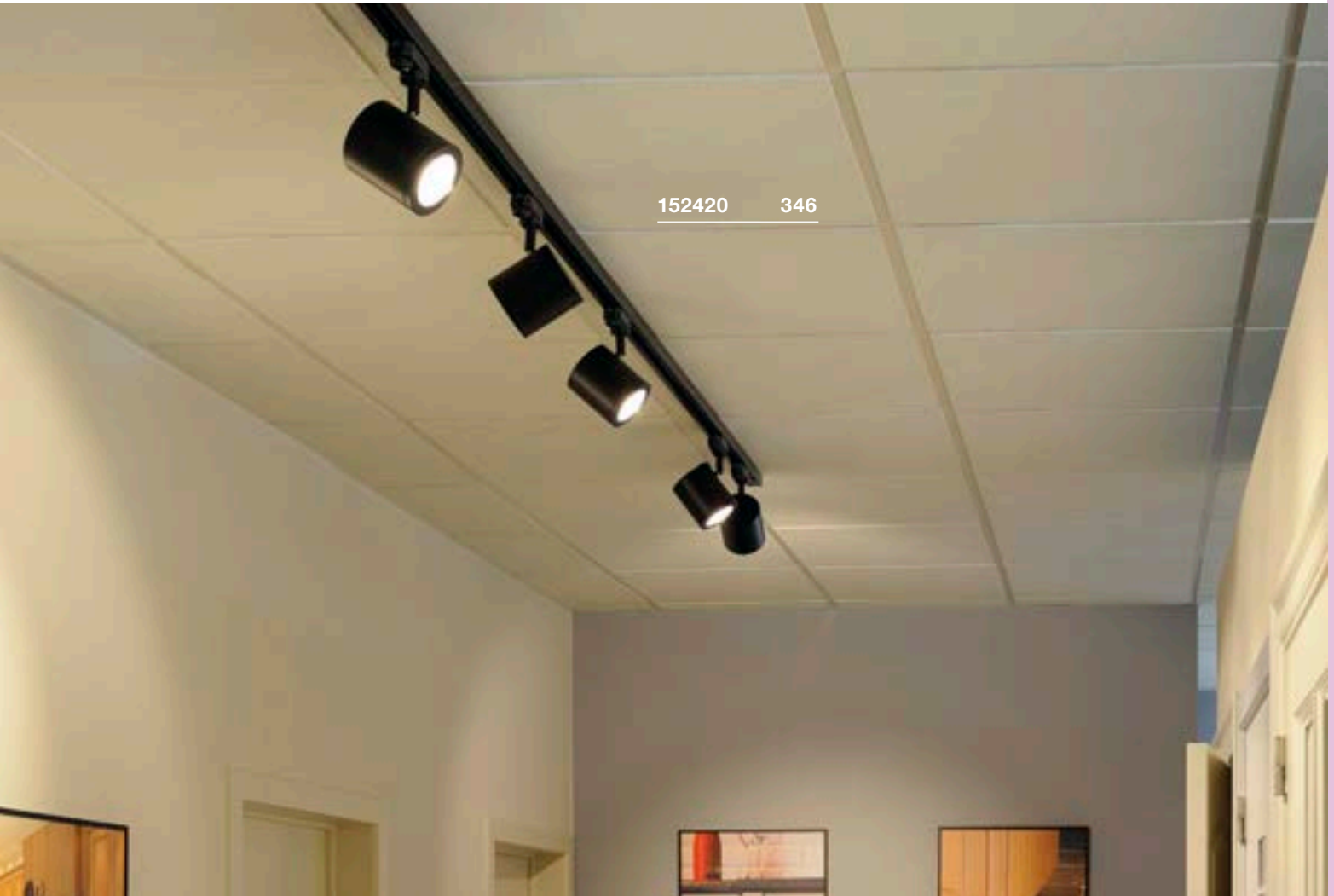

SPOT T
3Ph.



1001269 348

Produktangaben

220-240V ~50/60Hz
Systemleistung: 39W
Material: Aluminium / Kunststoff

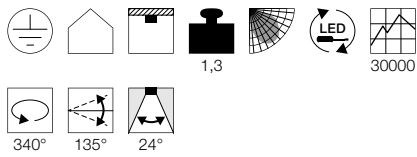

Maßzeichnung

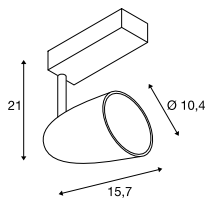

Variante	Art. Nr.
3100lm 3000K CRI>80	
■ schwarz	1001269
3100lm 3000K CRI>80	
□ weiß	1001270



152980 349

BILAS TRACK
3Ph., TRIAC



A-A++ Spektrum A++-E



• Hochvolt LED

Produktangaben

230V ~50/60Hz
Systemleistung: 16W
Material: Aluminium / Glas
Dimmbar: Triac C, Triac L

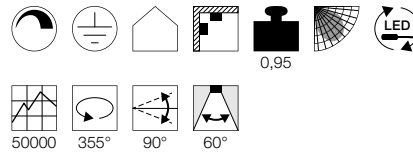

Maßzeichnung

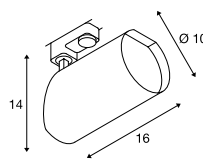

1001292 349

SIGHT TRACK
3Ph.



A-A++ Spektrum A++-E



Produktangaben

220-240V ~50/60Hz | 700mA
Systemleistung: 37W
Material: Aluminium / Acryl

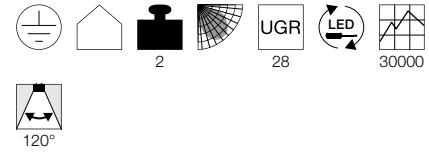

Maßzeichnung

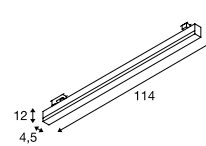

Variante	Art. Nr.
1000lm 2700K CRI>80	
■ matt schwarz	152980
1000lm 2700K CRI>80	
□ matt weiß	152981

Variante	Art. Nr.
3100lm 3000K CRI>80	
■ schwarz	1001289
3100lm 3000K CRI>80	
□ weiß	1001290
3100lm 3000K CRI>80	
■ grau	1001292

PURI TRACK
3Ph., QPAR51



E-A++ Spektrum
A++-E

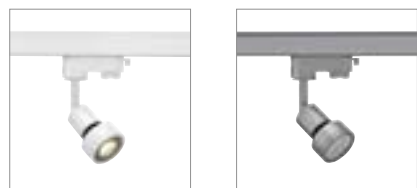

Produktangaben

220-240V ~50/60Hz
Material: Aluminium / Polycarbonat (PC)

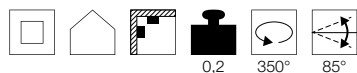

0,2 350° 85°

Maßzeichnung

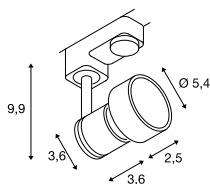

Leuchtmittlempfehlung

LED GU10 7,2W 36°
4000K 540lm EEK=A+
8kWh/1000h



Art. Nr. 1001565

LED GU10 7,2W 36°
2700K 520lm EEK=A+
8kWh/1000h



Art. Nr. 1001560

Leuchtmittelangaben

max. 50W QPAR51
Ø: 11 cm max. L: 7,8 cm max.
optional: QPAR111

Variante	Art. Nr.
GU10 QPAR51	
■ matt schwarz	153560
GU10 QPAR51	
□ weiß	153561
GU10 QPAR51	
■ grau	153564

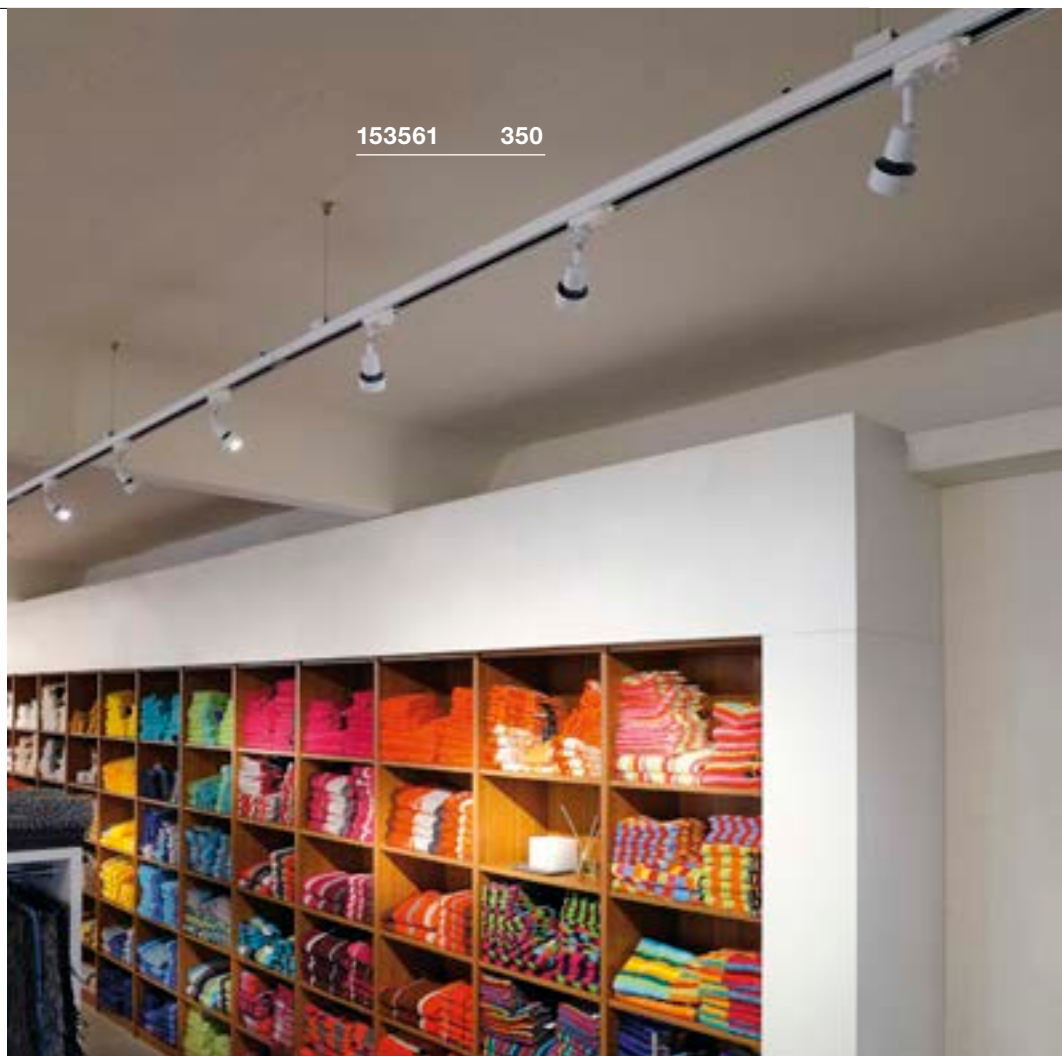

153561 350



153560 351

PURI TRACK
3Ph., QPAR51



E-A++ Spektrum A++-E

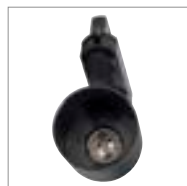

BIMA
3Ph., single, QPAR51



E-A++ Spektrum A++-E

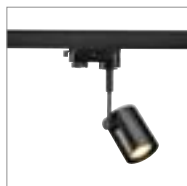

BIMA
3Ph., double, QPAR51



E-A++ Spektrum A++-E

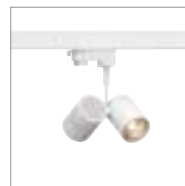
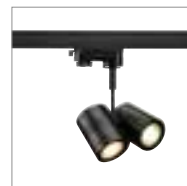

• Die Leuchtenköpfe sind gegenläufig schwenkbar

Produktangaben

230V ~50Hz
Material: Aluminium / Kunststoff



Maßzeichnung

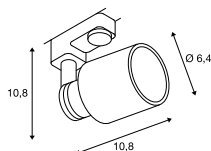

Produktangaben

220-240V ~50/60Hz
Material: Aluminium

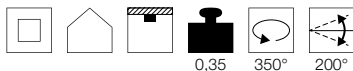

Maßzeichnung

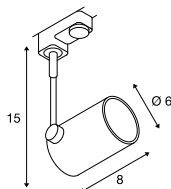

Produktangaben

220-240V ~50/60Hz
Material: Aluminium

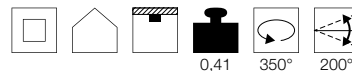

Maßzeichnung

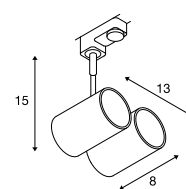

Leuchtmittlempfehlung

LED GU10 7,2W 36°
3000K 520lm EEK=A+
8kWh/1000h
Art. Nr. 1001563



LED GU10 5,5W 38°
2700K 400lm EEK=A+
6kWh/1000h
Art. Nr. 1001030



Leuchtmittelangaben

max. 10W QPAR51

Variante	Art. Nr.
GU10 QPAR51	
■ schwarz	1001871
GU10 QPAR51	
□ weiß	1001872
GU10 QPAR51	
■ grau	1001873

Leuchtmittlempfehlung

LED GU10 5,5W 38°
2700K 400lm EEK=A+
6kWh/1000h
Art. Nr. 1001030



LED GU10 7,2W 36°
3000K 520lm EEK=A+
8kWh/1000h
Art. Nr. 1001562



Leuchtmittelangaben

max. 50W QPAR51
Ø: 5 cm max. L: 5,7 cm max.

Variante	Art. Nr.
GU10 QPAR51	
■ matt schwarz	152240
GU10 QPAR51	
□ matt weiß	152241
GU10 QPAR51	
■ grau	152242

Leuchtmittlempfehlung

LED GU10 7,2W 36°
4000K 540lm EEK=A+
8kWh/1000h
Art. Nr. 1001565



LED GU10 7,2W 36°
2700K 520lm EEK=A+
8kWh/1000h
Art. Nr. 1001560



Leuchtmittelangaben

2x max. 50W QPAR51
Ø: 5 cm max. L: 5,7 cm max.

Variante	Art. Nr.
GU10 QPAR51	
■ matt schwarz	152230
GU10 QPAR51	
□ matt weiß	152231
GU10 QPAR51	
■ grau	152232

TEC KALU TRACK
3Ph., double, TRIAC



A-A++ Spektrum A++-E

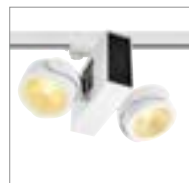

TEC KALU TRACK
3Ph., quad, TRIAC



A-A++ Spektrum A++-E

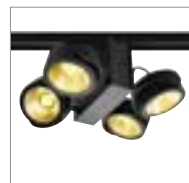

Produktangaben

220-240V ~50/60Hz | 700mA
Systemleistung: 31W
Material: Aluminium / Polycarbonat (PC)
Dimmbar: Triac C

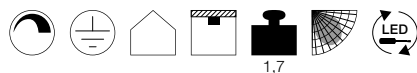

1,7



40000 360° 120°

Produktangaben

220-240V ~50/60Hz | 700mA
Systemleistung: 60W
Material: Aluminium / Polycarbonat (PC)
Dimmbar: Triac C

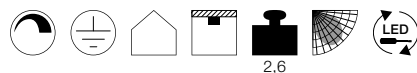

2,6



40000 360° 120°

Maßzeichnung

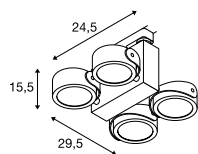

Maßzeichnung

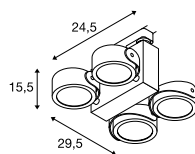

Variante	Art. Nr.
1900lm 3000K CRI>80 24° ■ schwarz	1001427
1900lm 3000K CRI>80 24° ■ weiß / schwarz	1001428
1900lm 3000K CRI>80 60° ■ schwarz	1001419
1900lm 3000K CRI>80 60° ■ weiß / schwarz	1001420

Variante	Art. Nr.
3800lm 3000K CRI>80 24° ■ schwarz	1001429
3800lm 3000K CRI>80 24° ■ weiß / schwarz	1001430
3800lm 3000K CRI>80 60° ■ schwarz	1001421
3800lm 3000K CRI>80 60° ■ weiß / schwarz	1001422





EURO CUBE
3Ph.

A-A++ Spektrum A++-E

LED INSIDE



- Premium LED mit CRI>90

Produktangaben

220-240V ~50/60Hz
Systemleistung: 28,5W
Material: Aluminium

1,2 25000

350° 170°

Maßzeichnung

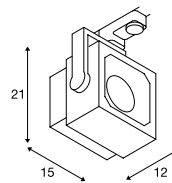

EURO CUBE
3Ph.

A-A++ Spektrum A++-E

LED INSIDE



- Premium LED mit CRI>90

Produktangaben

220-240V ~50/60Hz
Systemleistung: 28,5W
Material: Aluminium

1,2 25000

350° 170°

Maßzeichnung

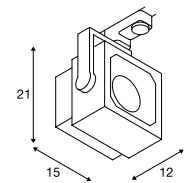

Variante	Art. Nr.
2100lm 3000K CRI>90 60°	
■ schwarz	152750
□ weiß	152751
■ grau	152754
1950lm 3000K CRI>90 90°	
■ schwarz	152760
□ weiß	152761
■ grau	152764

Variante	Art. Nr.
2150lm 4000K CRI>90 60°	
■ schwarz	152780
□ weiß	152781
■ grau	152784
2050lm 4000K CRI>90 90°	
■ schwarz	152790
□ weiß	152791
■ grau	152794

SUPROS 78 TRACK
3Ph., TRIAC



A-A++ Spektrum
A++-E

LED
INSIDE



152661 354

Produktangaben

220-240V ~50/60Hz | 250mA
Systemleistung: 12W
Material: Aluminium
Dimmbar: Triac C, Triac L

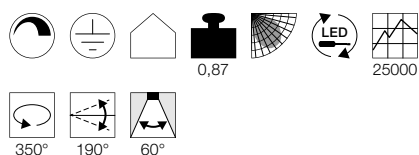

Maßzeichnung

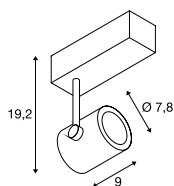

Zubehörempfehlung

- Linse 20°
Art. Nr. 116302
- Linse 40°
Art. Nr. 116304
- Abschatter
Art. Nr. 1000677
- Abschatter
Art. Nr. 1000678

Variante	Art. Nr.
700lm 3000K CRI>80 ■ schwarz	152660
700lm 3000K CRI>80 □ weiß	152661





152801

355



152620

355

SUPROS TRACK 3Ph.



A-A++ Spektrum A++-E

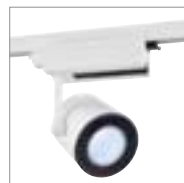

Produktangaben

220-240V ~50/60Hz | 750mA
Systemleistung: 31W
Material: Aluminium

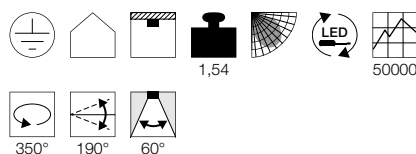

Maßzeichnung

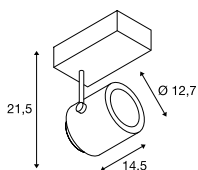

Hinweis

Weitere Farbtemperaturen auf Anfrage erhältlich

Zubehörempfehlung

- Reflek or 20°
Art. Nr. 114102
- Reflek or 40°
Art. Nr. 114104
- Abschatter
Art. Nr. 1000679
- Abschatter
Art. Nr. 1000680

Variante	Art. Nr.
2600lm 3000K CRI>80 ■ schwarz	152620
2600lm 3000K CRI>80 □ weiß	152621
2850lm 4000K CRI>80 ■ schwarz	152680
2850lm 4000K CRI>80 □ weiß	152681

SUPROS TRACK 3Ph.



A-A++ Spektrum A++-E



Produktangaben

220-240V ~50/60Hz | 950mA
Systemleistung: 36W
Material: Aluminium / Glas

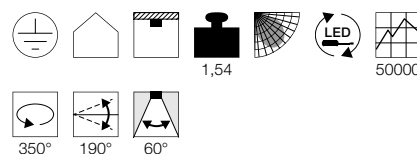

Maßzeichnung

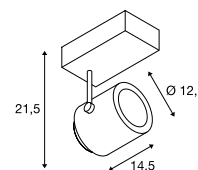

Hinweis

Weitere Farbtemperaturen auf Anfrage erhältlich

Zubehörempfehlung

- Reflek or 20°
Art. Nr. 114102
- Reflek or 40°
Art. Nr. 114104
- Abschatter
Art. Nr. 1000679
- Abschatter
Art. Nr. 1000680

Variante	Art. Nr.
3100lm 3000K CRI>80 ■ schwarz	152800
3100lm 3000K CRI>80 □ weiß	152801
3300lm 4000K CRI>80 ■ schwarz	152810
3300lm 4000K CRI>80 □ weiß	152811

STRUCTEC
3Ph.



A-A++ Spektrum A++-E



- Premium LED mit CRI>90

Produktangaben

220-240V ~50/60Hz
Systemleistung: 28W
Material: Aluminium

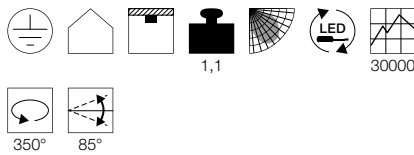

Maßzeichnung

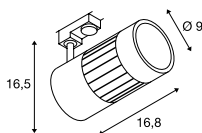

Variante	Art. Nr.
2700lm 3000K CRI>90 36°	
■ schwarz	1000980
2700lm 3000K CRI>90 36°	
□ weiß	1000981
2700lm 3000K CRI>90 36°	
■ grau	1000982
2650lm 3000K CRI>90 60°	
■ schwarz	1000983
2650lm 3000K CRI>90 60°	
□ weiß	1000984
2650lm 3000K CRI>90 60°	
■ grau	1000985
2800lm 4000K CRI>90 36°	
■ schwarz	1000986
2800lm 4000K CRI>90 36°	
□ weiß	1000987
2800lm 4000K CRI>90 36°	
■ grau	1000988
2750lm 4000K CRI>90 60°	
■ schwarz	1000989
2750lm 4000K CRI>90 60°	
□ weiß	1000990
2750lm 4000K CRI>90 60°	
■ grau	1000991

STRUCTEC
3Ph.



A-A++ Spektrum A++-E

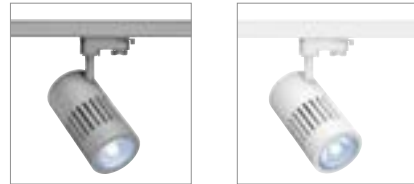

- Premium LED mit CRI>90

Produktangaben

220-240V ~50/60Hz
Systemleistung: 35W
Material: Aluminium

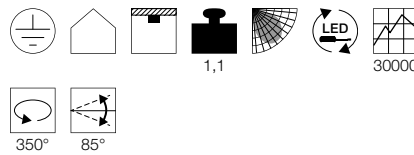

Maßzeichnung

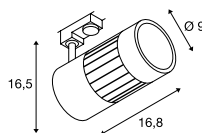

Variante	Art. Nr.
3200lm 3000K CRI>90 36°	
■ schwarz	1000992
3200lm 3000K CRI>90 36°	
□ weiß	1000993
3200lm 3000K CRI>90 36°	
■ grau	1000994
3150lm 3000K CRI>90 60°	
■ schwarz	1000995
3150lm 3000K CRI>90 60°	
□ weiß	1000996
3150lm 3000K CRI>90 60°	
■ grau	1000997
3450lm 4000K CRI>90 36°	
■ schwarz	1000998
3450lm 4000K CRI>90 36°	
□ weiß	1000999
3400lm 4000K CRI>90 60°	
■ schwarz	1001001
3400lm 4000K CRI>90 60°	
□ weiß	1001002
3400lm 4000K CRI>90 60°	
■ grau	1001003

STRUCTEC
3 Ph., R9



A-A++ Spektrum A++-E



- Premium LED
- Hohe Farbwiedergabeeigenschaft R9/CRI>95
- Schmale Formgebung vielseitig integrierbar

Produktangaben

220-240V ~50/60Hz | 900mA
Systemleistung: 35W
Material: Aluminium

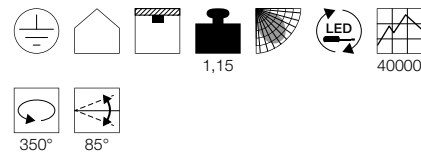

Maßzeichnung

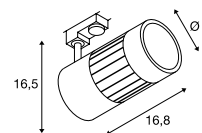

Variante	Art. Nr.
2460lm 3000K CRI>95 36°	
■ schwarz	176080
2460lm 3000K CRI>95 36°	
□ weiß	176081
2250lm 3000K CRI>95 60°	
■ schwarz	176090
2250lm 3000K CRI>95 60°	
□ weiß	176091



1000980 356

STRUCTEC ZOOM
3Ph.

896

A-A++ Spektrum A++-E



LED INSIDE



- Premium LED mit CRI>90
- Einstellbar von 25° bis 60°
- Moderne Lichtlösung für vielfältige Beleuchtungskonzepte

Produktangaben

220-240V ~50/60Hz
Systemleistung: 35W
Material: Aluminium

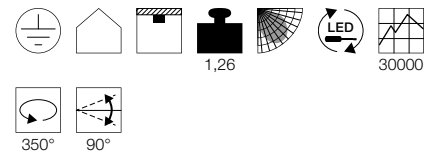

Maßzeichnung

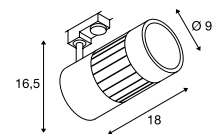

176081 356



1001002 356

Variante	Art. Nr.
3000lm 3000K CRI>90	
■ schwarz	1000656
3000lm 3000K CRI>90	
□ weiß	1000657
3000lm 3000K CRI>90	
■ grau	1000658

KALU TRACK
3Ph., QPAR111



E-A++ Spektrum
A++-E



KALU TRACK
3Ph., QR111



D-A+ Spektrum
A++-E



Produktangaben

230V ~50Hz |
Material: Aluminium / Kunststoff

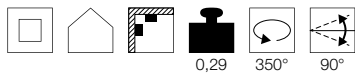

Produktangaben

230V ~50Hz | 12V AC
Material: Aluminium / Kunststoff

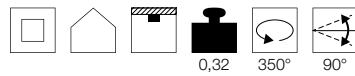

Maßzeichnung

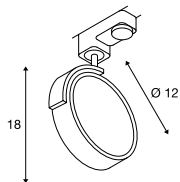

Maßzeichnung

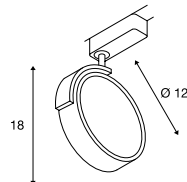

Leuchtmittlempfehlung

GU10 7,9W 40°
2700K 730lm EEK=A+
8kWh/1000h
Art. Nr. 560732



LED GU10 13W 140°
4000K 1100lm EEK=A+
13kWh/1000h
Art. Nr. 1001245



Leuchtmittlempfehlung

G53 15W 140°
2700K 680lm EEK=A
16kWh/1000h
Art. Nr. 551612



LED G53 15W 40°
3000K 760lm EEK=A
17kWh/1000h
Art. Nr. 560234



Leuchtmittelangaben

max. 75W QPAR111

Leuchtmittelangaben

max. 50W QR111

Variante	Art. Nr.
GU10 QPAR111	
■ schwarz	152610
GU10 QPAR111	
□ weiß	152611
GU10 QPAR111	
■ grau	152614

Variante	Art. Nr.
G53 QR111	
■ schwarz	153580
G53 QR111	
□ weiß	153581
G53 QR111	
■ grau	153584



152614 358



153580 358



152601 359



153600 359

KALU TRACK
3Ph., TRIAC



A-A++ Spektrum A++-E



KALU TRACK
3Ph., TRIAC



A-A++ Spektrum A++-E



• Leuchteneinheit 340° dreh- und 120° schwenkbar

Produktangaben

220-240V ~50/60Hz
Systemleistung: 13W
Material: Aluminium
Dimmbar: Triac C

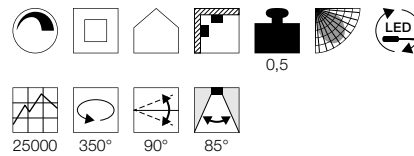

Maßzeichnung

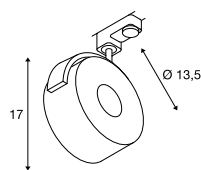

Produktangaben

220-240V ~50/60Hz | 350mA
Systemleistung: 17W
Material: Aluminium / Polycarbonat (PC)
Dimmbar: Triac C

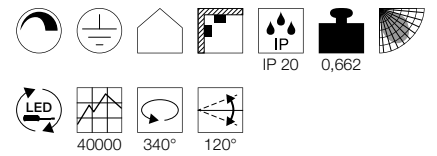

Maßzeichnung

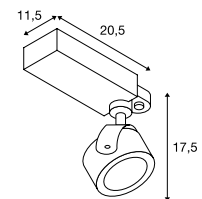

Variante	Art. Nr.
860lm 3000K CRI>80	
■ schwarz	152600
860lm 3000K CRI>80	
□ weiß	152601

Variante	Art. Nr.
1000lm 3000K CRI>80 24°	
■ schwarz	153600
1000lm 3000K CRI>80 60°	
■ schwarz	1000769

EURO SPOT TRACK
3Ph., QPAR51

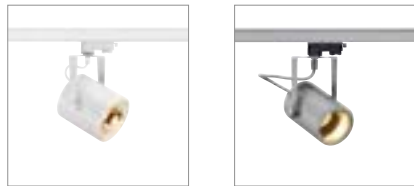
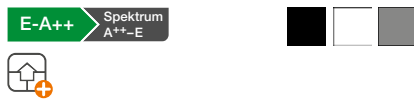

Produktangaben

230V ~50Hz
Material: Aluminium / Glas

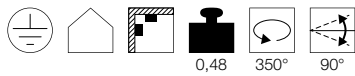

Maßzeichnung

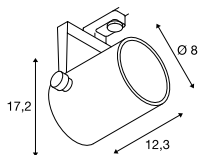

Leuchtmittlempfehlung

LED GU10 7,2W 36°
4000K 540lm EEK=A+
8kWh/1000h
Art. Nr. 1001565



LED GU10 7W 25/40/55°
3000K 300lm EEK=A
7kWh/1000h
Art. Nr. 560603



Leuchtmittelangaben

max. 25W QPAR51

Variante	Art. Nr.
GU10 QPAR51	
■ schwarz	153850
GU10 QPAR51	
□ weiß	153851
GU10 QPAR51	
■ grau	153854

EURO SPOT TRACK
3Ph., QPAR111

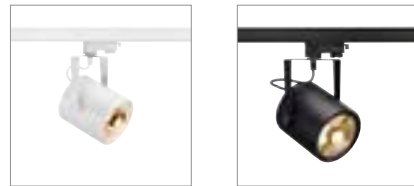
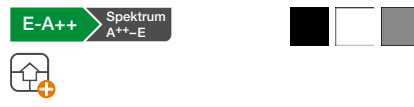

Produktangaben

230V ~50Hz
Material: Aluminium



Maßzeichnung

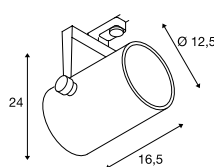

Leuchtmittlempfehlung

LED GU10 10W 38°
3000K 630lm EEK=A+
10kWh/1000h
Art. Nr. 1001029



LED GU10 7W 13°
3000K 660lm EEK=A+
8kWh/1000h
Art. Nr. 1001568



Leuchtmittelangaben

max. 75W QPAR111

Variante	Art. Nr.
GU10 QPAR111	
■ schwarz	153420
GU10 QPAR111	
□ weiß	153421
GU10 QPAR111	
■ grau	153424

153851 360



153810 361



EURO SPOT TRACK
3Ph.



A-A++ Spektrum A++-E

LED
INSIDE



Produktangaben

220-240V ~50/60Hz
Systemleistung: 11W
Material: Aluminium

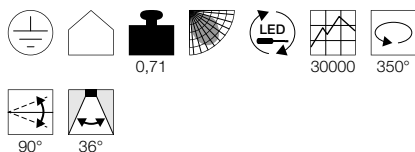

Maßzeichnung

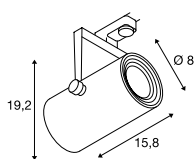

Variante	Art. Nr.
650lm 3000K CRI>80 ■ schwarz	1001367
650lm 3000K CRI>80 □ weiß	1001368
650lm 3000K CRI>80 ■ grau	1001369

EURO SPOT TRACK
3Ph., TRIAC



A-A++ Spektrum A++-E

LED
INSIDE



Produktangaben

220-240V ~50/60Hz
Systemleistung: 21W
Material: Aluminium
Dimmbar: Triac C, Triac L

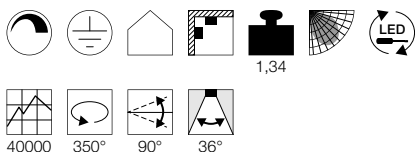

Maßzeichnung

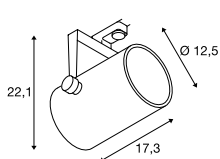

Variante	Art. Nr.
1350lm 3000K CRI>80 ■ schwarz	153810
1350lm 3000K CRI>80 □ weiß	153811
1350lm 3000K CRI>80 ■ grau	153814

EURO SPOT TRACK
3Ph.



A-A++ Spektrum A++-E

LED
INSIDE



Produktangaben

220-240V ~50/60Hz | 1500mA
Systemleistung: 61W
Material: Aluminium / Glas

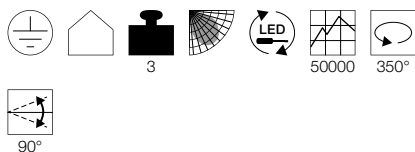

Maßzeichnung

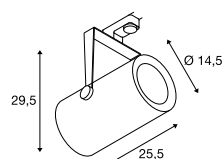

Variante	Art. Nr.
5500lm 3000K CRI>80 12° ■ schwarz	1001476
5500lm 3000K CRI>80 12° □ weiß	1001477
5500lm 3000K CRI>80 12° ■ grau / transparent	1001478
5500lm 3000K CRI>80 38° ■ schwarz	1001484
5500lm 3000K CRI>80 38° □ weiß	1001480
5500lm 3000K CRI>80 38° ■ grau / transparent	1001479
5500lm 3000K CRI>80 60° ■ schwarz	1001481
5500lm 3000K CRI>80 60° □ weiß	1001482
5500lm 3000K CRI>80 60° ■ grau / transparent	1001483

SIGHT TRACK
3Ph., PD



A-A++ Spektrum
A++-E



Produktangaben

220-240V ~50/60Hz | 700mA
Systemleistung: 40W
Material: Aluminium / Acryl

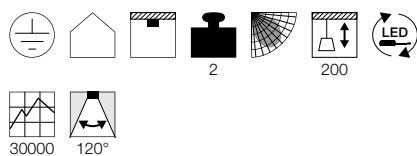

Maßzeichnung

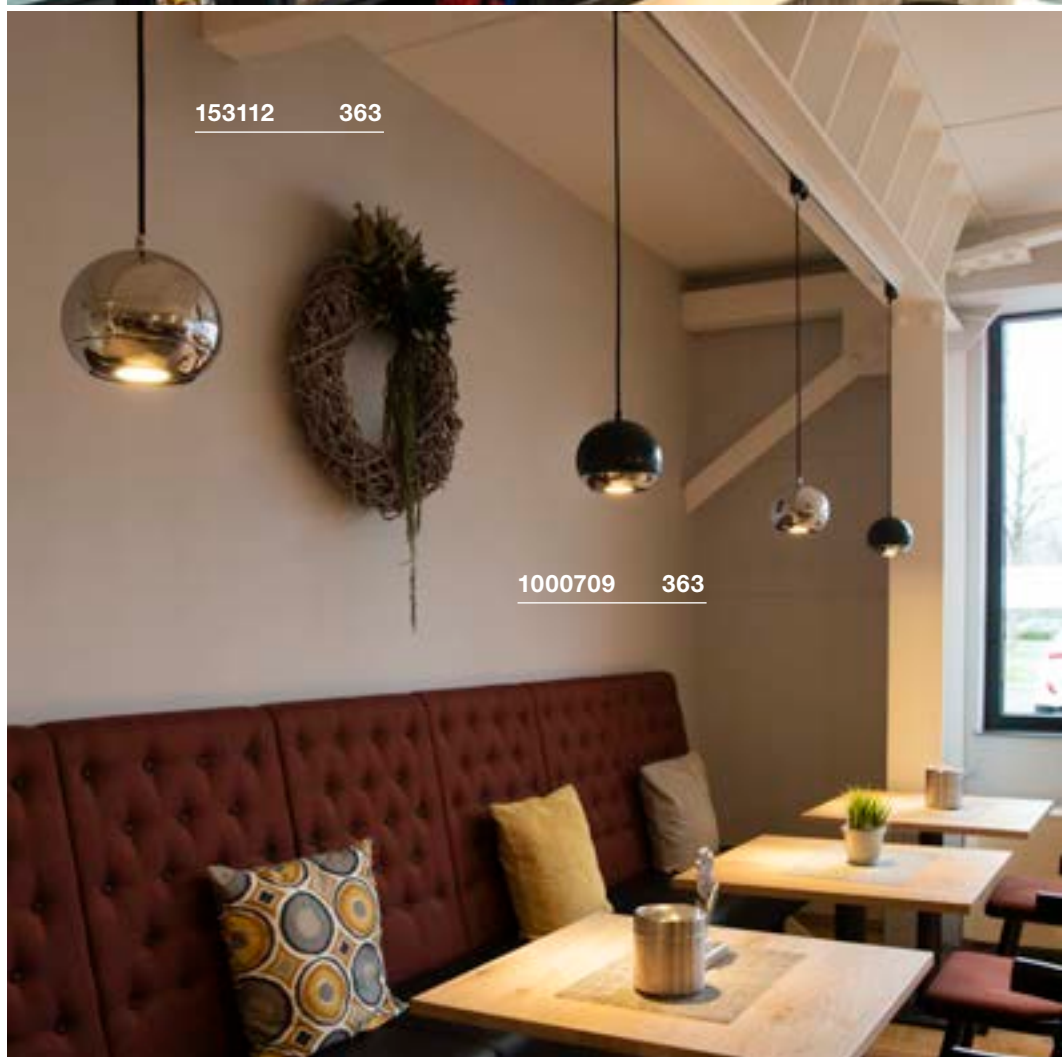
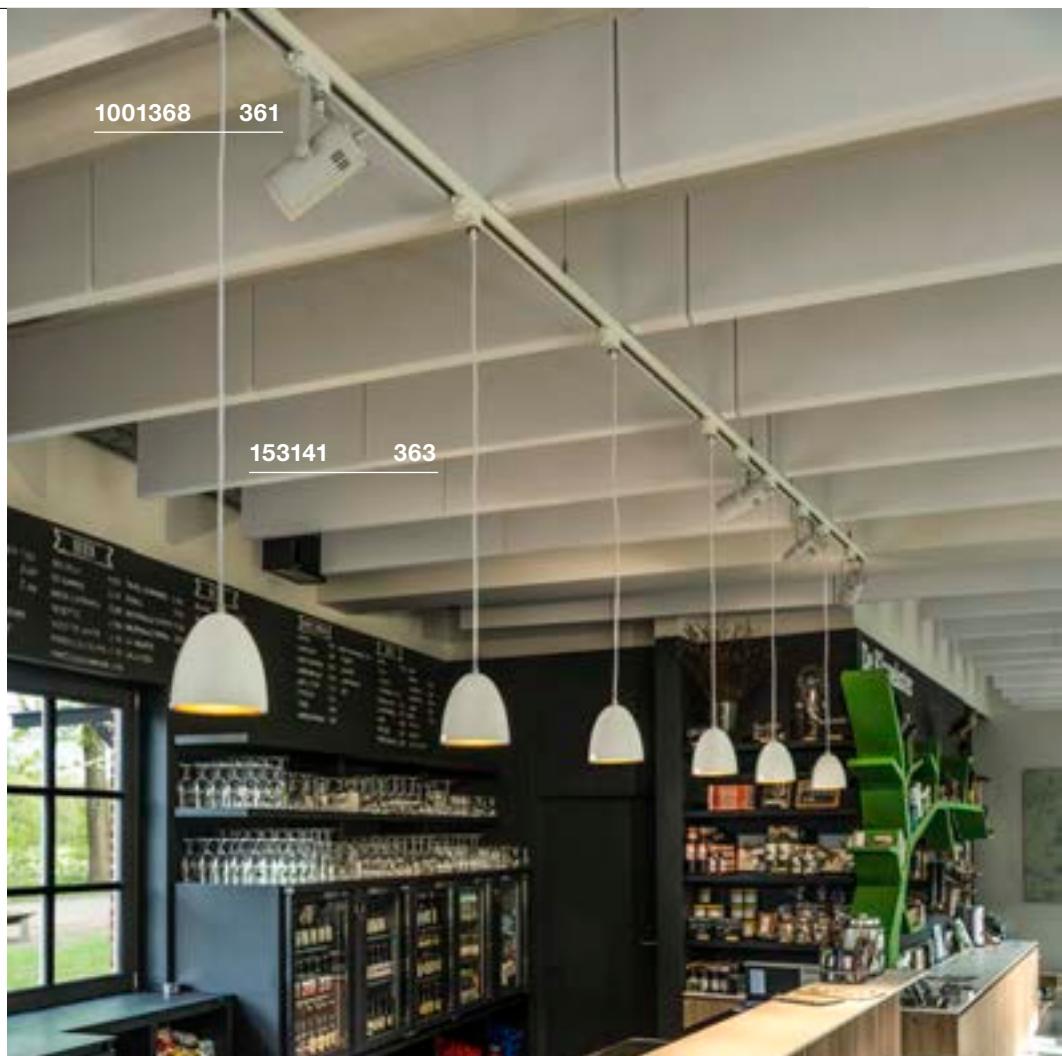
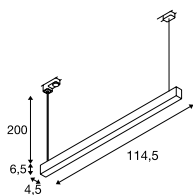

Variante	Art. Nr.
3100lm 3000K CRI>80	
■ schwarz	1002048
3100lm 3000K CRI>80	
□ weiß	1002049
3100lm 3000K CRI>80	
■ grau	1002050

LIGHT EYE® 150
3Ph., PD, QPAR111



E-A++ Spektrum A++-E

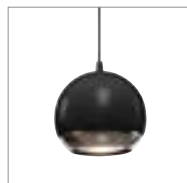

PARA CONE 14
3Ph., PD, QPAR51



E-A++ Spektrum A++-E

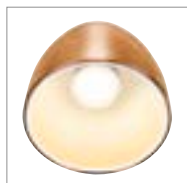

FORCHINI M 40 TRACK
3Ph., PD, E27



E-A++ Spektrum A++-E



- Doppelwandige Konstruktion mit innenliegendem Reflekt
- Textilkabel in Gehäusefarbe

Produktangaben

230V ~50Hz
Material: Stahl

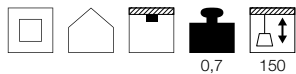

0,7 150

Maßzeichnung

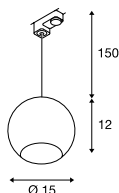

Produktangaben

220-240V ~50/60Hz
Material: Aluminium

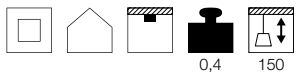

0,4 150

Maßzeichnung

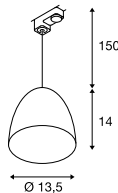

Produktangaben

230V ~50Hz
Material: Aluminium / Stahl

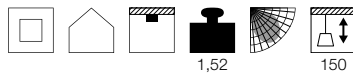

1,52 150

Maßzeichnung

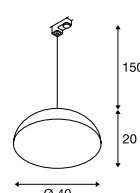

Leuchtmittlempfehlung

LED GU10 10W 38°
3000K 630lm EEK=A+
10kWh/1000h
Art. Nr. 1001029



LED GU10 9,5W 25°
2200-6700K 750lm
Art. Nr. 1001922



Leuchtmittelangaben

max. 75W QPAR111

Variante	Art. Nr.
GU10 QPAR111	
■ schwarz / chrom	1000709
GU10 QPAR111	
■ weiß / chrom	1000710
GU10 QPAR111	
■ chrom	153112

Leuchtmittlempfehlung

LED E27 7W 330°
2700K 806lm EEK=A+
8kWh/1000h
Art. Nr. 1001035



LED E27 7W 280°
2200-2700K 830lm EEK=A++
7kWh/1000h
Art. Nr. 1002126



Leuchtmittelangaben

max. 35W QPAR51

Variante	Art. Nr.
GU10 QPAR51	
■ kupfer	1002686
GU10 QPAR51	
■ glänzend schwarz	153140
GU10 QPAR51	
□ weiß	153141

Leuchtmittlempfehlung

LED E27 7W 330°
2700K 806lm EEK=A+
8kWh/1000h
Art. Nr. 1001035



LED E27 7W 280°
2200-2700K 830lm EEK=A++
7kWh/1000h
Art. Nr. 1002126



Leuchtmittelangaben

max. 40W
Ø: 6,8 cm max. L: 15,2 cm max.

Variante	Art. Nr.
E27	
■ schwarz / gold	153130
E27	
■ weiß / gold	153131

PLANUNGSHILFE S-TRACK 3PHASEN-AUFBAUSCHIENE

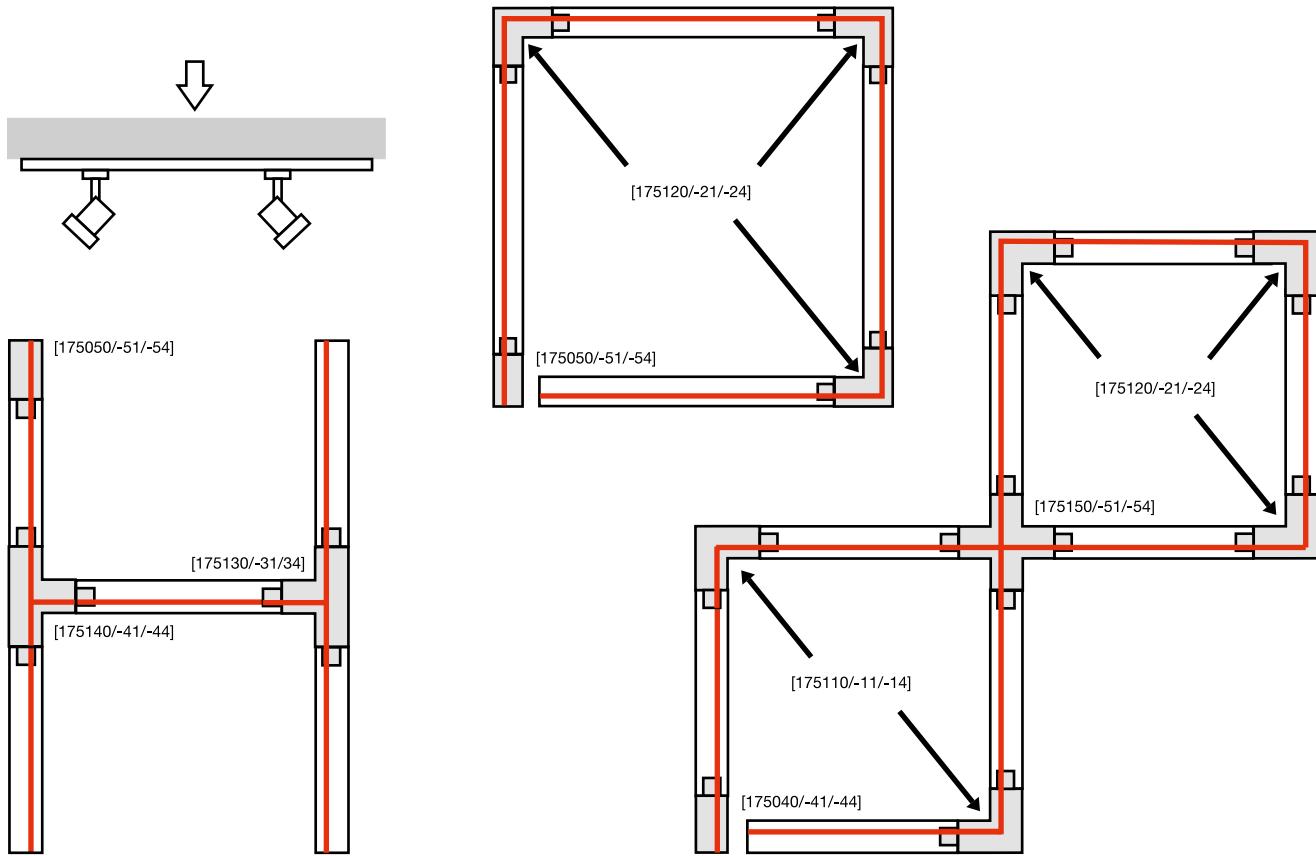

S-TRACK 3PHASEN-AUFBAUSCHIENE

				
		S-TRACK 3Phasen Aufbauschiene, 1m	S-TRACK 3Phasen Aufbauschiene, 1m	S-TRACK 3Phasen Aufbauschiene, 1m
				
Bemessungsspannung	220-250V ~50Hz	220-250V ~50Hz	220-250V ~50Hz	220-250V ~50Hz
Strombelastung max.	16A	16A	16A	16A
Einspeisemöglichkeit	nein	nein	nein	nein
Material	Aluminium / Kunststoff	Aluminium / Kunststoff	–	–
Farbe	schwarz	weiß	–	–
Länge	99,5 cm	99,5 cm	99,5 cm	99,5 cm
Breite	3,6 cm	3,6 cm	3,6 cm	3,6 cm
Höhe	3,6 cm	3,6 cm	3,6 cm	3,6 cm
Gewicht	0,9 kg	0,9 kg	0,9 kg	0,9 kg
Art. Nr.	175010	1001375	175014	

				
		S-TRACK 3Phasen Aufbauschiene, 2m	S-TRACK 3Phasen Aufbauschiene, 2m	S-TRACK 3Phasen Aufbauschiene, 2m
				
Bemessungsspannung	220-250V ~50Hz	220-250V ~50Hz	220-250V ~50Hz	220-250V ~50Hz
Strombelastung max.	16A	16A	16A	16A
Einspeisemöglichkeit	nein	nein	nein	nein
Material	Aluminium / Kunststoff	Aluminium / Kunststoff	–	–
Farbe	schwarz	weiß	–	–
Länge	199,5 cm	199,5 cm	199,5 cm	199,5 cm
Breite	3,6 cm	3,6 cm	3,6 cm	3,6 cm
Höhe	3,6 cm	3,6 cm	3,6 cm	3,6 cm
Gewicht	1,8 kg	1,8 kg	1,8 kg	1,8 kg
Art. Nr.	175020	1001376	175024	

				
		S-TRACK 3Phasen Aufbauschiene, 3m	S-TRACK 3Phasen Aufbauschiene, 3m	S-TRACK 3Phasen Aufbauschiene, 3m
				
Bemessungsspannung	220-250V ~50Hz	220-250V ~50Hz	220-250V ~50Hz	220-250V ~50Hz
Strombelastung max.	16A	16A	16A	16A
Einspeisemöglichkeit	nein	nein	nein	nein
Material	Aluminium / Kunststoff	Aluminium / Kunststoff	–	–
Farbe	schwarz	weiß	–	–
Länge	299,5 cm	299,5 cm	299,5 cm	299,5 cm
Breite	3,6 cm	3,6 cm	3,6 cm	3,6 cm
Höhe	3,6 cm	3,6 cm	3,6 cm	3,6 cm
Gewicht	2,7 kg	2,7 kg	2,7 kg	2,7 kg
Art. Nr.	175030	1001377	175034	



152960 346

175100 367

ZUBEHÖR S-TRACK 3PHASEN-AUFBAUSCHIENE

3Ph-Adapter mit Haken

Kunststoff / tahl
 Ø: 2,6 cm H: 5,2 cm
 Gewicht: 0,01 kg
 Max. 10 kg
 1 Stk.



Variante	Art. Nr.
■ schwarz	175190
□ weiß	1001393
■ grau	175194

Mini-Verbinder

16A max.
 Aluminium / Kunststoff
 L: 6,8 cm B: 2,5 cm H: 2,6 cm
 Gewicht: 0,03 kg
 1 Stk.



Variante	Art. Nr.
■ schwarz	175070
□ weiß	1001381
■ grau	175074

Mini-Verbinder, mechanisch

Kunststoff
 L: 6,8 cm B: 3,1 cm H: 2,6 cm
 Gewicht: 0,02 kg
 1 Stk.



Variante	Art. Nr.
■ schwarz	175080
□ weiß	1001382
■ grau	175084

Leuchtenadapter

16A max.
 Aluminium / Kunststoff
 L: 8,4 cm B: 5,5 cm H: 3,3 cm
 Gewicht: 0,08 kg
 Inkl. Zugentlastung
 Max. 10 kg
 1 Stk.



Variante	Art. Nr.
■ schwarz	175200
□ weiß	1001394
■ grau	175204

L-Verbinder, Erde innen

16A max.
 Aluminium / Kunststoff
 L: 6,7 cm B: 6,7 cm H: 3,3 cm
 Gewicht: 0,11 kg
 Erde innen, mit Einspeisemöglichkeit.
 1 Stk.



Variante	Art. Nr.
■ schwarz	175110
□ weiß	1001385
■ grau	175114

Flexverbinder

16A max.
 Aluminium / Kunststoff
 L: 16,2 cm B: 3,5 cm H: 3,3 cm
 Gewicht: 0,14 kg
 1 Stk.



Variante	Art. Nr.
■ schwarz	175100
□ weiß	1001384
■ grau	175104

Leuchtenadapter, mechanisch

Aluminium / Kunststoff
 L: 6,6 cm B: 6,6 cm H: 3,1 cm
 Gewicht: 0,14 kg
 Max. 10 kg
 1 Stk.



Variante	Art. Nr.
■ schwarz	175210
□ weiß	1001395
■ grau	175214

L-Verbinder, Erde außen

16A max.
 Aluminium / Kunststoff
 L: 6,7 cm B: 6,7 cm H: 3,3 cm
 Gewicht: 0,11 kg
 Erde außen, mit Einspeisemöglichkeit.
 1 Stk.



Variante	Art. Nr.
■ schwarz	175120
□ weiß	1001386
■ grau	175124

Stoßstellenverbinder

Aluminium
 L: 18,2 cm B: 3,3 cm H: 2,1 cm
 Gewicht: 0,08 kg
 1 Stk.



Variante	Art. Nr.
■ schwarz	175180
□ weiß	1001392
■ grau	175184

Einspeiser, Erde rechts

16A max.
 Aluminium / Kunststoff
 L: 6,5 cm B: 3,5 cm H: 3,3 cm
 Gewicht: 0,06 kg
 Erde rechts.
 1 Stk.



Variante	Art. Nr.
■ schwarz	175040
□ weiß	1001378
■ grau	175044

X-Verbinder

16A max.
 Aluminium / Kunststoff
 L: 10 cm B: 10 cm H: 3,3 cm
 Gewicht: 0,23 kg
 2 Stromkreise.
 1 Stk.



Variante	Art. Nr.
■ schwarz	175150
□ weiß	1001389
■ grau	175154

Deckenabhangung

Edelstahl / Messing
 L: 500 cm
 Gewicht: 0,2 kg
 Max. 10 kg
 2 Stk.



Variante	Art. Nr.
■ nickel	1002845

Einspeiser, Erde links

16A max.
 Aluminium / Kunststoff
 L: 6,5 cm B: 3,5 cm H: 3,3 cm
 Gewicht: 0,06 kg
 Erde links.
 1 Stk.



Variante	Art. Nr.
■ schwarz	175050
□ weiß	1001379
■ grau	175054

T-Verbinder, Erde links

16A max.
 Aluminium / Kunststoff
 L: 10 cm B: 6,7 cm H: 3,3 cm
 Gewicht: 0,17 kg
 Erde links, mit Einspeisemöglichkeit.
 1 Stk.



Variante	Art. Nr.
■ schwarz	175130
□ weiß	1001387
■ grau	175134

Drahtseilabhangung-Set mit Stange

Aluminium / Kunststoff
 L: 100 cm B: 6 cm H: 4 cm
 Gewicht: 0,2 kg
 Max. 10 kg
 1 Stk.



Variante	Art. Nr.
■ schwarz	175160
□ weiß	1001390
■ grau	175164

Längsverbinder mit Einspeisemöglichkeit

16A max.
 Aluminium / Kunststoff
 L: 9,9 cm B: 3,5 cm H: 3,3 cm
 Gewicht: 0,11 kg
 Mit Einspeisemöglichkeit.
 1 Stk.



Variante	Art. Nr.
■ schwarz	175090
□ weiß	1001383
■ grau	175094

T-Verbinder, Erde rechts

16A max.
 Aluminium / Kunststoff
 L: 10 cm B: 6,7 cm H: 3,3 cm
 Gewicht: 0,17 kg
 Erde rechts, mit Einspeisemöglichkeit.
 1 Stk.



Variante	Art. Nr.
■ schwarz	175140
□ weiß	1001388
■ grau	175144

Endkappe

Kunststoff
 L: 3,5 cm B: 3,3 cm H: 3,2 cm
 Gewicht: 0,01 kg
 1 Stk.



Variante	Art. Nr.
■ schwarz	175060
□ weiß	1001380
■ grau	175064

PLANUNGSHILFE EUTRAC® 3PHASEN-AUFBAUSCHIENE

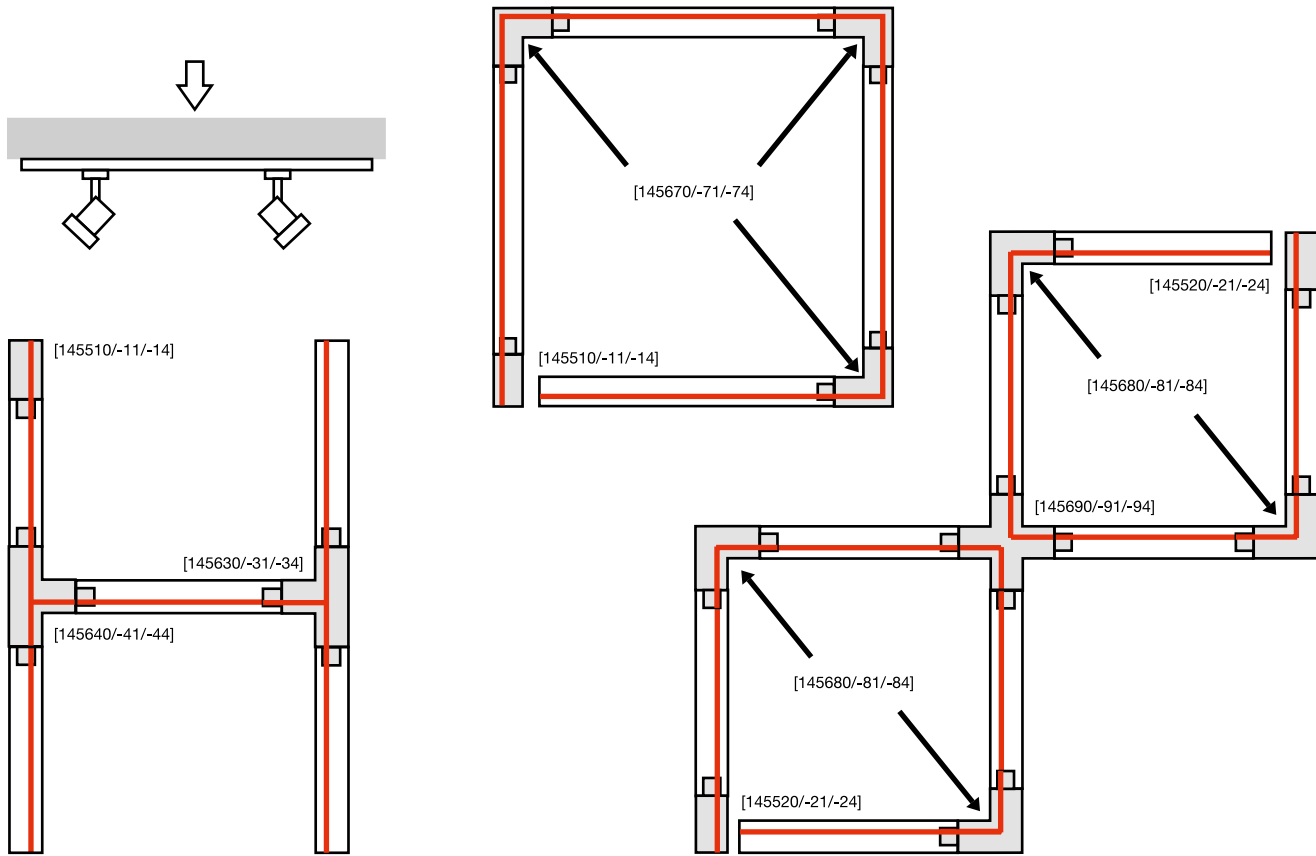

EUTRAC® 3PHASEN-AUFBAUSCHIENE

				
		EUTRAC® 3Phasen Aufbauschiene, 1m	EUTRAC® 3Phasen Aufbauschiene, 1m	EUTRAC® 3Phasen Aufbauschiene, 1m
	 	 	 	
Bemessungsspannung	230V ~50Hz	230V ~50Hz	230V ~50Hz	230V ~50Hz
Strombelastung max.	16A	16A	16A	16A
Einspeisemöglichkeit	nein	nein	nein	nein
Material	Aluminium / Kunststoff	Aluminium / Kunststoff	Aluminium / Kunststoff	Aluminium / Kunststoff
Farbe	schwarz	weiß	weiß	grau
Länge	100 cm	100 cm	100 cm	100 cm
Breite	3,6 cm	3,6 cm	3,6 cm	3,6 cm
Höhe	3,2 cm	3,2 cm	3,2 cm	3,2 cm
Gewicht	1 kg	1 kg	1 kg	1 kg
Art. Nr.	145100	1001510	145102	

				
		EUTRAC® 3Phasen Aufbauschiene, 2m	EUTRAC® 3Phasen Aufbauschiene, 2m	EUTRAC® 3Phasen Aufbauschiene, 2m
	 	 	 	
Bemessungsspannung	230V ~50Hz	230V ~50Hz	230V ~50Hz	230V ~50Hz
Strombelastung max.	16A	16A	16A	16A
Einspeisemöglichkeit	nein	nein	nein	nein
Material	Aluminium / Kunststoff	Aluminium / Kunststoff	Aluminium / Kunststoff	Aluminium / Kunststoff
Farbe	schwarz	weiß	weiß	grau
Länge	200 cm	200 cm	200 cm	200 cm
Breite	3,6 cm	3,6 cm	3,6 cm	3,6 cm
Höhe	3,2 cm	3,2 cm	3,2 cm	3,2 cm
Gewicht	2 kg	2 kg	2 kg	2 kg
Art. Nr.	145200	1001511	145202	

				
		EUTRAC® 3Phasen Aufbauschiene, 3m	EUTRAC® 3Phasen Aufbauschiene, 3m	EUTRAC® 3Phasen Aufbauschiene, 3m
	 	 	 	
Bemessungsspannung	230V ~50Hz	230V ~50Hz	230V ~50Hz	230V ~50Hz
Strombelastung max.	16A	16A	16A	16A
Einspeisemöglichkeit	nein	nein	nein	nein
Material	Aluminium / Kunststoff	Aluminium / Kunststoff	Aluminium / Kunststoff	Aluminium / Kunststoff
Farbe	schwarz	weiß	weiß	grau
Länge	300 cm	300 cm	300 cm	300 cm
Breite	3,6 cm	3,6 cm	3,6 cm	3,6 cm
Höhe	3,2 cm	3,2 cm	3,2 cm	3,2 cm
Gewicht	3 kg	3 kg	3 kg	3 kg
Art. Nr.	145300	1001512	145302	

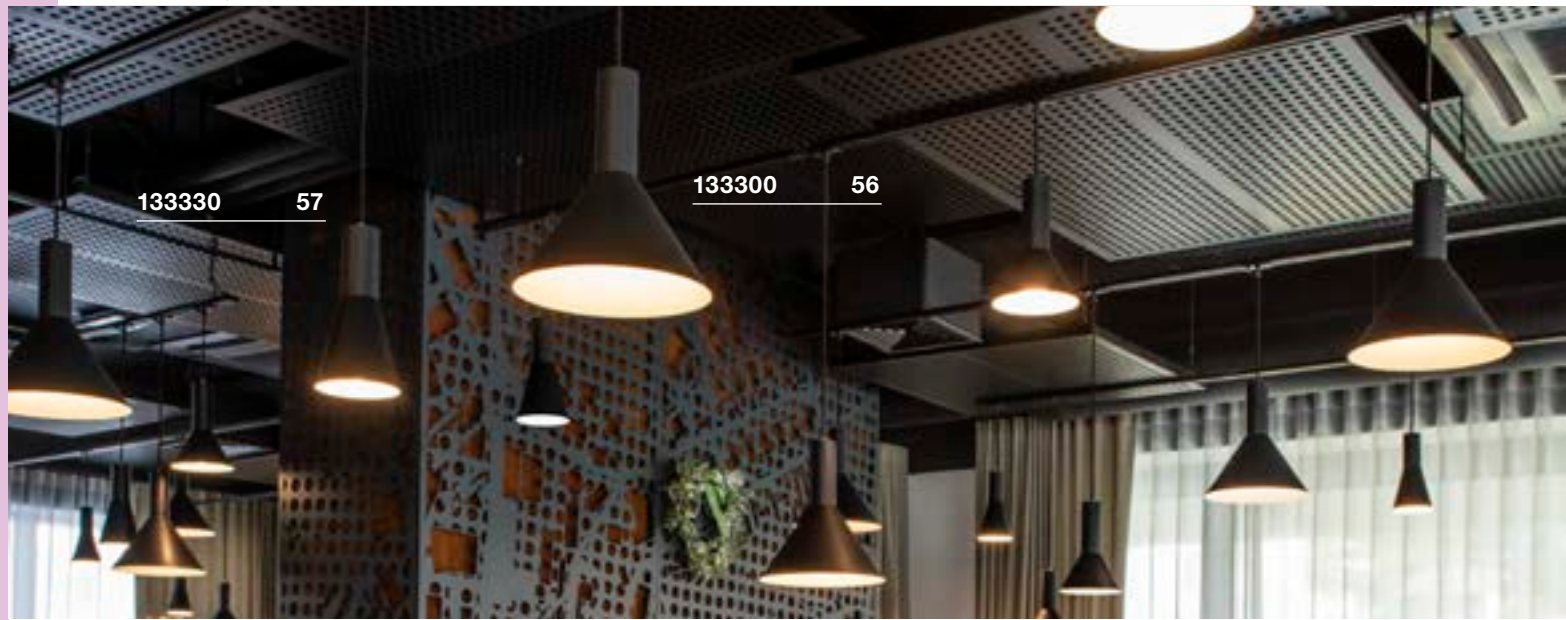

133330

57

133300

56

ZUBEHÖR EUTRAC® 3PHASEN-AUFBAUSCHIENE

Einspeiser, links

16A max.
Kunststoff
L: 11,2 cm B: 3,6 cm H: 3,2 cm
Gewicht: 0,08 kg
Erde links.
1 Stk.



Variante	Art. Nr.
■ schwarz	145510
□ weiß	1001513
■ grau	145514

Längsverbinder mit Einspeisemöglichkeit

16A max.
Kunststoff / tahl
L: 26 cm B: 3,6 cm H: 3,2 cm
Gewicht: 0,15 kg
1 Stk.



Variante	Art. Nr.
■ schwarz	145660
□ weiß	1001517
■ grau	145664

Einspeiser, rechts

16A max.
Kunststoff
L: 11,2 cm B: 3,6 cm H: 3,2 cm
Gewicht: 0,08 kg
Erde rechts
1 Stk.



Variante	Art. Nr.
■ schwarz	145520
□ weiß	1001514
■ grau	145524

T-Verbinder, Erde links

16A max.
Kunststoff / tahl
L: 26 cm B: 18,5 cm H: 3,2 cm
Gewicht: 0,35 kg
1 Stk.



Variante	Art. Nr.
■ schwarz	145630
□ weiß	1001518
■ grau	145634

Mitteinspeiser

16A max.
Kunststoff
L: 13 cm B: 3,6 cm H: 3,6 cm
Gewicht: 0,08 kg
1 Stk.



Variante	Art. Nr.
■ schwarz	145530
□ weiß	1001515
■ grau	145534

T-Verbinder, Erde rechts

16A max.
Kunststoff / tahl
L: 26 cm B: 18,5 cm H: 3,2 cm
Gewicht: 0,35 kg
1 Stk.



Variante	Art. Nr.
■ schwarz	145640
□ weiß	1001519
■ grau	145644

Längsverbinder

16A max.
Kunststoff
L: 5,8 cm B: 1,5 cm H: 2,6 cm
Gewicht: 0,03 kg
1 Stk.



Variante	Art. Nr.
■ schwarz	145560
□ weiß	1001516
■ grau	145564

L-Verbinder, Erde außen

16A max.
Kunststoff / tahl
L: 15 cm B: 15 cm H: 3,2 cm
Gewicht: 0,24 kg
1 Stk.



Variante	Art. Nr.
■ schwarz	145670
□ weiß	1001520
■ grau	145674

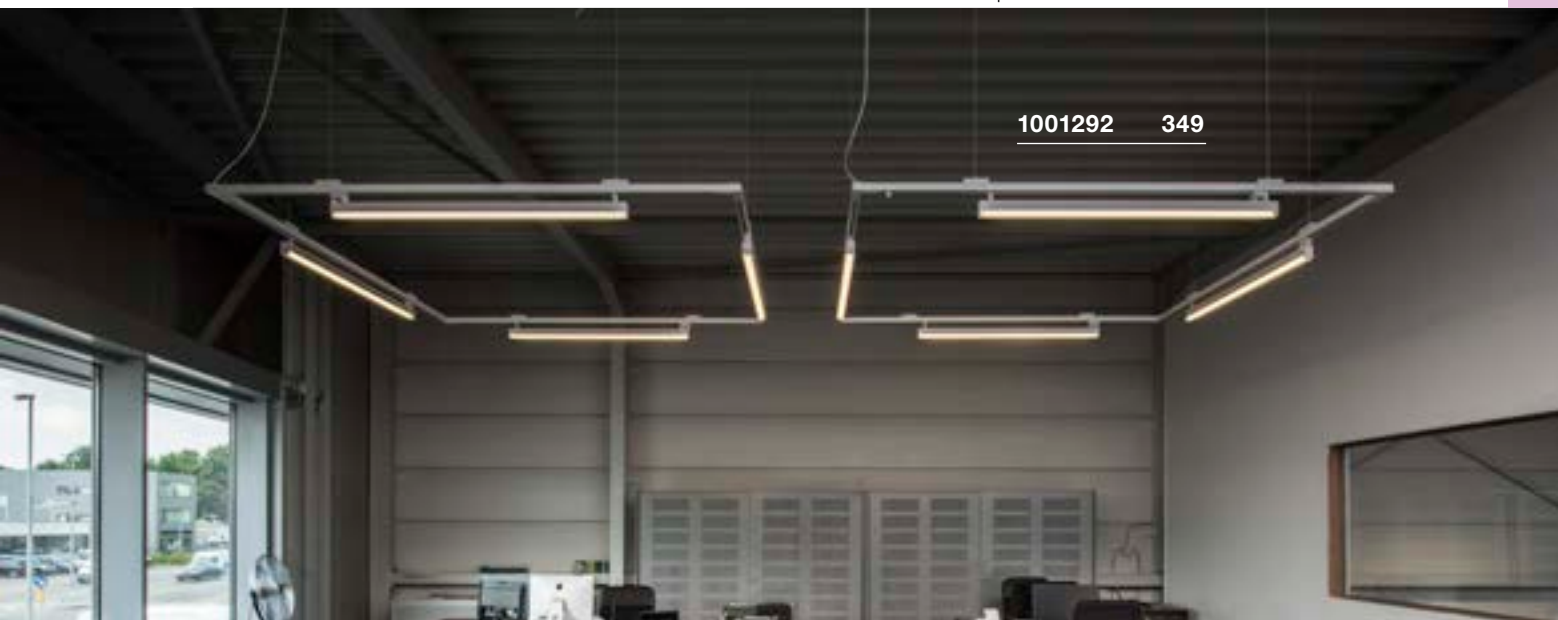

1001292 349

ZUBEHÖR EUTRAC® 3PHASEN-AUFBAUSCHIENE

L-Verbinder, Erde innen

16A max.
Kunststoff / tahl
L: 15 cm B: 15 cm H: 3,2 cm
Gewicht: 0,24 kg
1 Stk.



Variante	Art. Nr.
■ schwarz	145680
□ weiß	1001521
■ grau	145684

Steckdose

6,3A max.
Kunststoff
L: 9,6 cm B: 6,5 cm H: 9 cm
Gewicht: 0,17 kg
1 Stk.



Variante	Art. Nr.
■ schwarz	145700
□ weiß	1001525

Pendelabhängung, starr

Kunststoff / tahl
Ø: 7 cm L: 120 cm H: 122 cm
Gewicht: 0,49 kg
1 Stk.



Variante	Art. Nr.
■ schwarz	145710
□ weiß	1001528
■ grau	145714

X-Verbinder

16A max.
Kunststoff / tahl
L: 26 cm B: 26 cm H: 3,2 cm
Gewicht: 0,27 kg
1 Stk.



Variante	Art. Nr.
■ schwarz	145690
□ weiß	1001522
■ grau	145694

Universal Punktauslass

16A max.
Kunststoff
Ø: 11,9 cm H: 3,1 cm
1 Stk.



Variante	Art. Nr.
□ weiß	1001526
■ grau	145834
■ schwarz	145830

Pendelabhängung, starr

Kunststoff / tahl
Ø: 7 cm L: 60 cm H: 63,5 cm
Gewicht: 0,28 kg
1 Stk.



Variante	Art. Nr.
■ schwarz	145720
□ weiß	1001529
■ grau	145724

Stoßstellenverbinder

Kunststoff
L: 10 cm B: 3,6 cm H: 1,9 cm
Gewicht: 0,06 kg
1 Stk.



Variante	Art. Nr.
■ schwarz	145600
□ weiß	1001523
■ grau	145604

Endkappe

Kunststoff
L: 3,6 cm B: 1,7 cm H: 3,2 cm
Gewicht: 0,01 kg
2 Stk.



Variante	Art. Nr.
■ schwarz	145590
□ weiß	1001527
■ grau	145594

Pendelclip

Aluminium
L: 5 cm B: 3,6 cm H: 1,9 cm
Gewicht: 0,04 kg
1 Stk.



Variante	Art. Nr.
■ schwarz	145730
□ weiß	1001530
■ grau	145734

Flexverbinder

16A max.
Kunststoff / tahl
L: 22 cm B: 3,6 cm H: 3,2 cm
Gewicht: 0,23 kg
1 Stk.



Variante	Art. Nr.
■ schwarz	145580
□ weiß	1001524
■ grau	145584

Deckenabhängung

Edelstahl / Messing
L: 500 cm
Gewicht: 0,2 kg
2 Stk.



Variante	Art. Nr.
■ nickel	1002845

Pendelleuchtenadapter 3-Phasen

10A max.
Kunststoff
1 Stk.



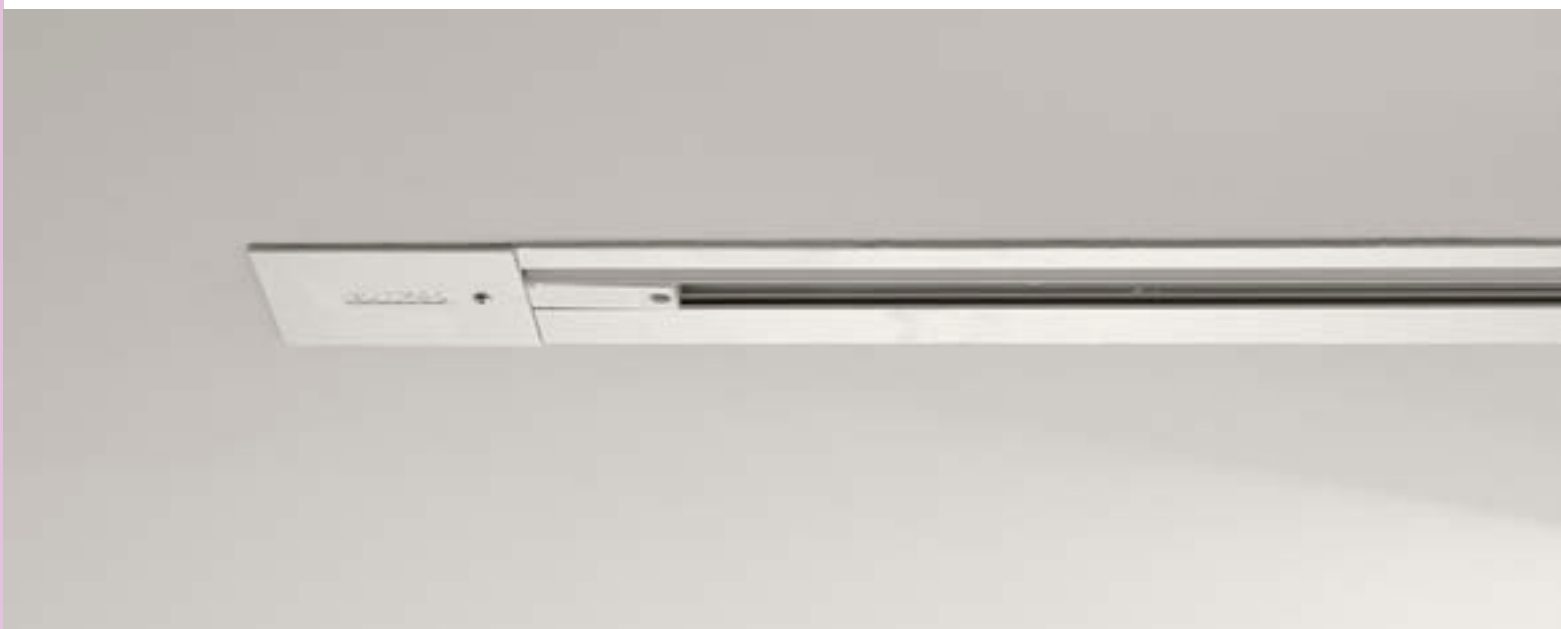

Variante	Art. Nr.
■ schwarz	145990
□ weiß	1001542
■ grau	145994



3PHASEN-EINBAUSCHIENE

Einbauschiene

	EUTRAC® 3Phasen Einbauschiene, 2 m	EUTRAC® 3Phasen Einbauschiene, 3 m
		
Bemessungsspannung	230V ~50Hz	230V ~50Hz
Strombelastung max.	16A	16A
Material	Aluminium/Kunststoff	Aluminium/Kunststoff
Farbe	weiß	weiß
Länge	200 cm	300 cm
Breite	5,9 cm	5,9 cm
Höhe	4,1 cm	4,1 cm
Einbau-B	4 cm	4 cm
Gewicht	2,6 kg	3,9 kg
Art. Nr.	1001531	1001532



ZUBEHÖR 3PHASEN-EINBAUSCHIENE

Einspeiser, Schutzleiter links

16A max.
Kunststoff / tahl
L: 12,2 cm B: 6 cm H: 3,4 cm
Gewicht: 0,1 kg
1 Stk.



Variante	Art. Nr.
<input type="checkbox"/> weiß	1001533

Endkappe

Kunststoff
L: 2,7 cm B: 6 cm H: 3,2 cm
Gewicht: 0,02 kg
1 Stk.



Variante	Art. Nr.
<input type="checkbox"/> weiß	1001538

Montage Federclip

Stahl
L: 2 cm B: 1 cm H: 2,5 cm
Gewicht: 0,03 kg
6 Stk.



Variante	Art. Nr.
<input checked="" type="checkbox"/> grau	145551

Einspeiser, Schutzleiter rechts

16A max.
Kunststoff / tahl
L: 12,2 cm B: 6 cm H: 3,4 cm
Gewicht: 0,1 kg
1 Stk.



Variante	Art. Nr.
<input type="checkbox"/> weiß	1001534

L-Verbinder

16A max.
Kunststoff / tahl
L: 16 cm B: 16 cm H: 3,2 cm
Gewicht: 0,24 kg
Erde innen, mit Einspeisemöglichkeit
1 Stk.



Variante	Art. Nr.
<input type="checkbox"/> weiß	1001537

Pendelleuchtenadapter

10A max.
Kunststoff
Gewicht: 0,07 kg
1 Stk.



Variante	Art. Nr.
<input checked="" type="checkbox"/> schwarz	145990
<input type="checkbox"/> weiß	1001542
<input checked="" type="checkbox"/> grau	145994

L-Verbinder

16A max.
Kunststoff / tahl
L: 16 cm B: 16 cm H: 3,2 cm
Gewicht: 0,24 kg
Erde außen, mit Einspeisemöglichkeit
1 Stk.



Variante	Art. Nr.
<input type="checkbox"/> weiß	1001536

Längsverbinder

16A max.
Kunststoff / tahl
L: 6,2 cm B: 2,5 cm H: 2,7 cm
Gewicht: 0,09 kg
1 Stk.



Variante	Art. Nr.
<input type="checkbox"/> weiß	1001539

HALTEN, WAS SIE VERSPRECHEN.

2-PHASEN-DESIGNSCHIENE FÜR GEHOBENES WOHNAMBIENTE.

Wo Funktionalität und Komfort aufeinandertreffen, entstehen hohe Anforderungen an das passende Produkt. Die D-TRACK® 2-Phasen-Designschiene ist daher die perfekte Lösung für alle, die optische Highlights setzen und dabei alle Möglichkeiten der Lichtgestaltung nutzen möchten.

140261 378

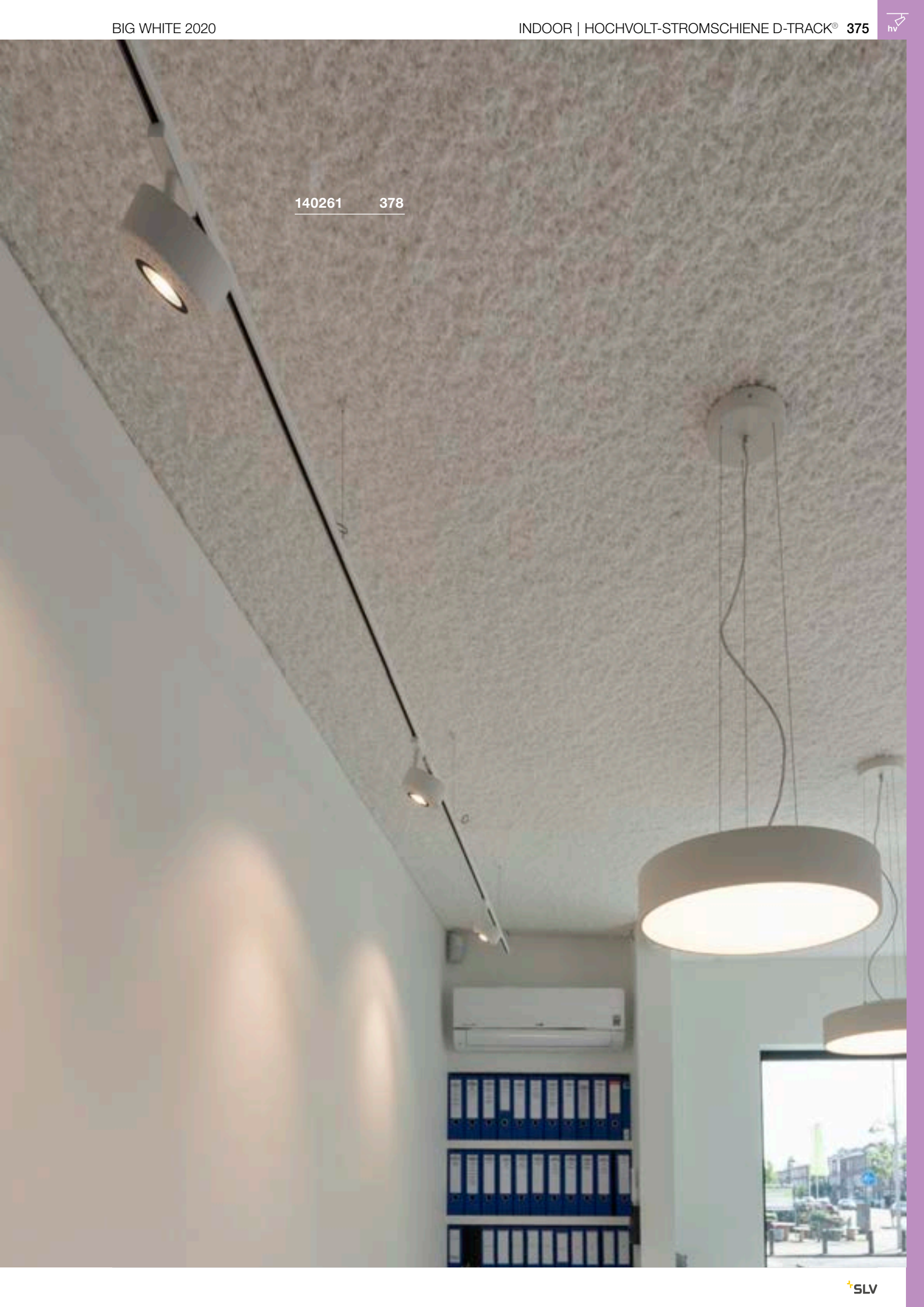



1001354 378

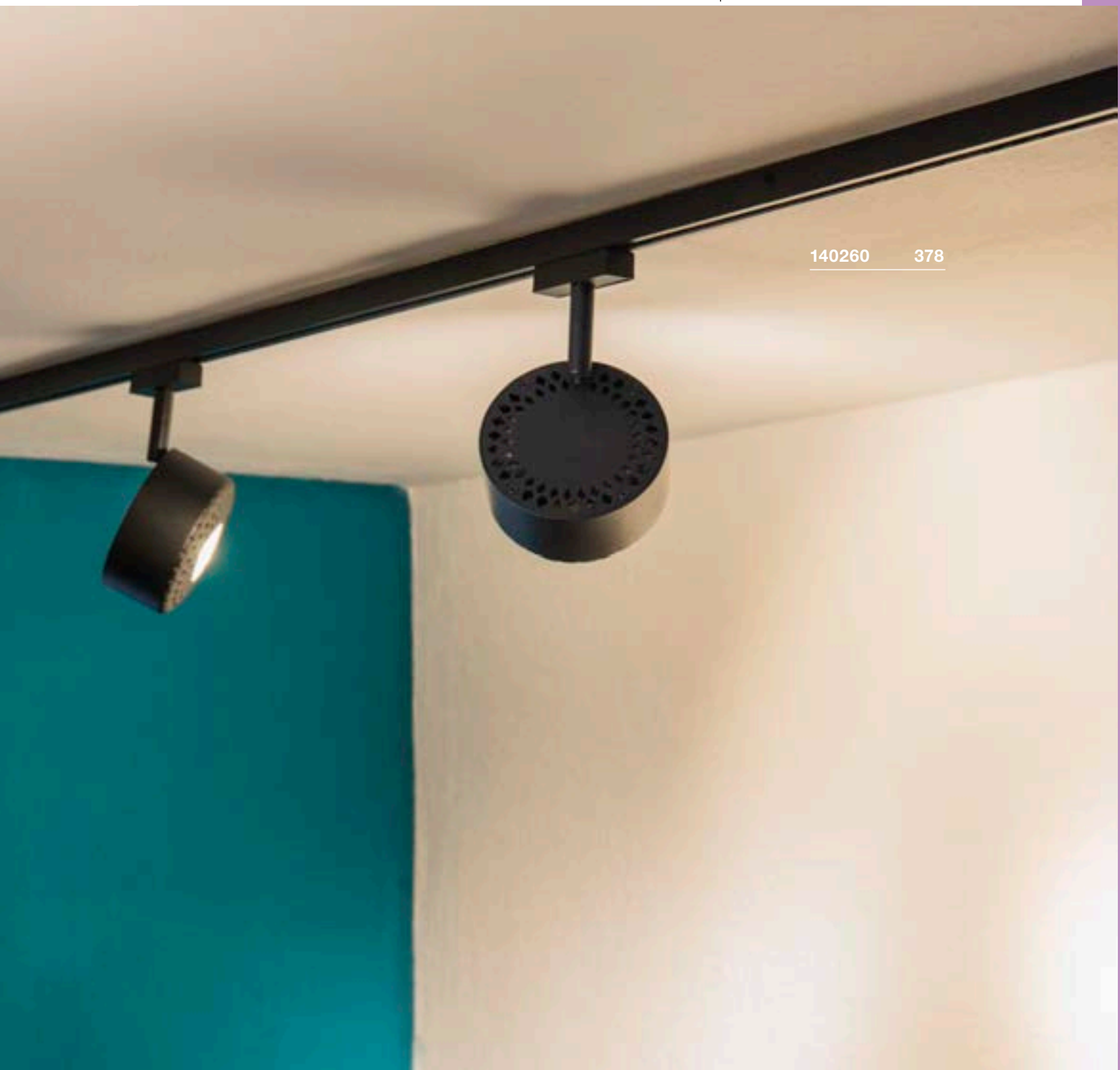

140260

378

HOCHVOLT-STROMSCHIENE D-TRACK®



Passende Stromschienen und Zubehör finden Sie auf den Seiten 380-381

 Weitere Leuchten und Varianten finden Sie online unter www.slv.com

REVILO TRACK
D-TRACK®



REVILO
D-TRACK®



TOTHEE
D-TRACK®, TRIAC



Produktangaben

220-240V ~50/60Hz
Systemleistung: 9,5W
Material: Aluminium / Stahl

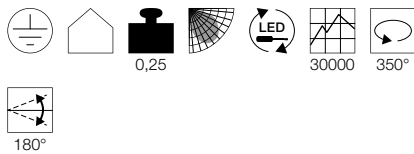

Maßzeichnung

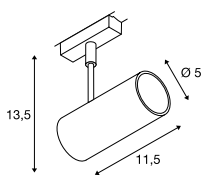

Zubehörempfehlung

- Dekoring Art. Nr. 140240
- Dekoring Art. Nr. 140241
- Dekoring Art. Nr. 140243

Variante	Art. Nr.
620lm 2700K CRI>80 15° ■ schwarz	140200
620lm 2700K CRI>80 15° □ weiß	140201
620lm 2700K CRI>80 36° ■ schwarz	140210
620lm 2700K CRI>80 36° □ weiß	140211

Produktangaben

220-240V ~50/60Hz
Systemleistung: 9,5W
Material: Aluminium / Stahl

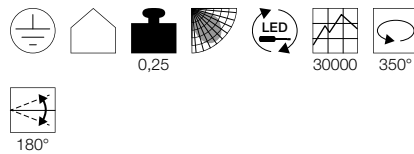

Maßzeichnung

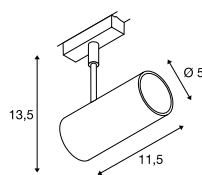

Zubehörempfehlung

- Dekoring Art. Nr. 140240
- Dekoring Art. Nr. 140241
- Dekoring Art. Nr. 140243

Variante	Art. Nr.
670lm 3000K CRI>80 15° ■ schwarz	1001352
550lm 3000K CRI>80 15° □ weiß	140221
670lm 3000K CRI>80 36° ■ schwarz	1001354
670lm 3000K CRI>80 36° □ weiß	1001355

Produktangaben

220-240V ~50/60Hz | 350mA
Systemleistung: 17W
Material: Aluminium
Dimmbar: Triac C, Triac L

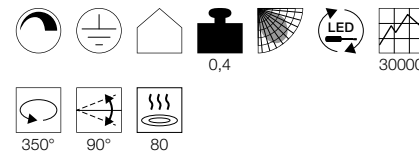

Maßzeichnung

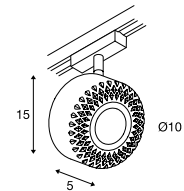

Variante	Art. Nr.
1250lm 3000K CRI>80 25° ■ schwarz	140250
1250lm 3000K CRI>80 25° □ weiß	140251
1250lm 3000K CRI>80 50° ■ schwarz	140260
1250lm 3000K CRI>80 50° □ weiß	140261



1001355 378



140250 378

D-TRACK®



Stromschiene 1m



D-TRACK®
1m, 2 Ph. Aufbauschiene



D-TRACK®
1m, 2 Ph. Aufbauschiene

Bemessungsspannung	230V ~50Hz/60Hz	230V ~50Hz/60Hz
Strombelastung max.	10A	10A
mech. Belastung max.	100N	100N
mech. Belastung max.	10 kg	10 kg
Material	Aluminium / Kunststoff	Aluminium / Kunststoff
Farbe	schwarz	weiß
Länge	100 cm	100 cm
Breite	1,8 cm	1,8 cm
Höhe	1,8 cm	1,8 cm
Gewicht	0,4 kg	0,4 kg
Art. Nr.	172010	172011

Hinweis Max. 10A pro Phase. Max. 10A pro Phase.



Stromschiene 2m



D-TRACK®
2m, 2 Ph. Aufbauschiene



D-TRACK®
2m, 2 Ph. Aufbauschiene

Bemessungsspannung	230V ~50Hz/60Hz	230V ~50Hz/60Hz
Strombelastung max.	10A	10A
mech. Belastung max.	200N	200N
mech. Belastung max.	20 kg	20 kg
Material	Aluminium / Kunststoff	Aluminium / Kunststoff
Farbe	schwarz	weiß
Länge	200 cm	200 cm
Breite	1,8 cm	1,8 cm
Höhe	1,8 cm	1,8 cm
Gewicht	0,8 kg	0,8 kg
Art. Nr.	172020	172021

Hinweis Max. 10A pro Phase. Max. 10A pro Phase.



Stromschiene 3m



D-TRACK®
3m, 2Ph. Aufbauschiene



D-TRACK®
3m, 2Ph. Aufbauschiene

Bemessungsspannung	230V ~50Hz/60Hz	230V ~50Hz/60Hz
max. Strombelastung	10A	10A
mech. Belastung max.	300N	300N
mech. Belastung max.	30 kg	30 kg
Material	Aluminium / Kunststoff	Aluminium / Kunststoff
Farbe	schwarz	weiß
Länge	295 cm	295 cm
Breite	1,8 cm	1,8 cm
Höhe	1,8 cm	1,8 cm
Gewicht	1,2 kg	1,2 kg
Art. Nr.	172030	172031

Hinweis Max. 10A pro Phase. Max. 10A pro Phase.

PLANUNGSHILFE D-TRACK®

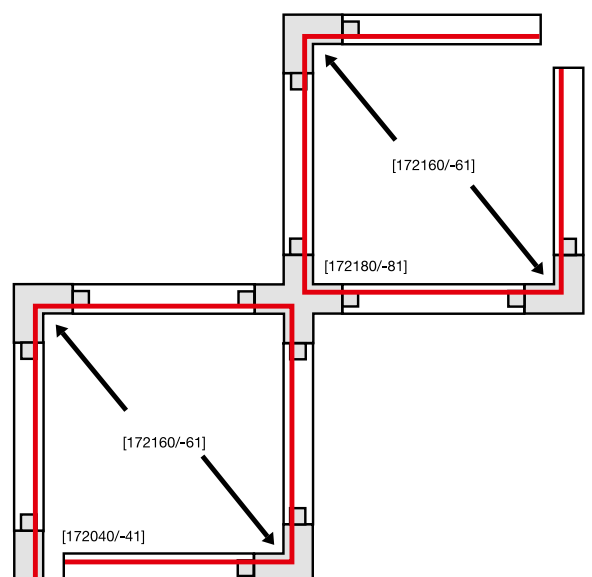
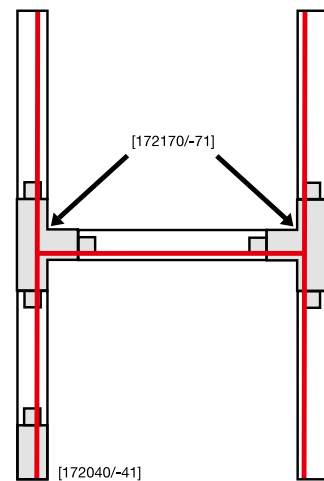
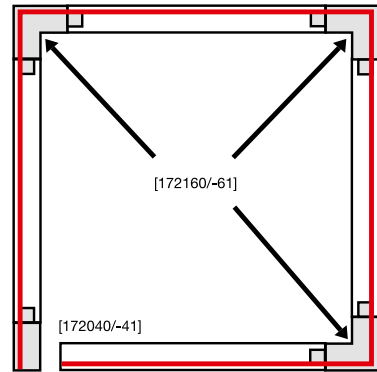
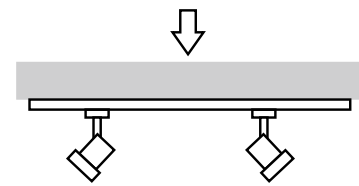

ZUBEHÖR D-TRACK®

Endeinspeiser

10A max.
Aluminium / Stahl
L: 22 cm B: 1,8 cm H: 1,8 cm
Gewicht: 0,09 kg
1 Stk.



Variante	Art. Nr.
<input checked="" type="checkbox"/> schwarz	172040
<input type="checkbox"/> weiß	172041

Endeinspeiser

10A max.
Aluminium / Kunststoff
L: 9,4 cm B: 1,8 cm H: 1,8 cm
Gewicht: 0,42 kg
1 Stk.



Variante	Art. Nr.
<input checked="" type="checkbox"/> schwarz	172090
<input type="checkbox"/> weiß	172091

Isolierverbinder

Stahl / Kunststoff
L: 7 cm B: 1,5 cm H: 1,5 cm
Gewicht: 0,03 kg
1 Stk.



Variante	Art. Nr.
<input type="checkbox"/> transparent	172145

Mitteleinspeiser

10A max.
Aluminium / Stahl
L: 37,5 cm B: 1,8 cm H: 1,8 cm
Gewicht: 0,26 kg
1 Stk.



Variante	Art. Nr.
<input checked="" type="checkbox"/> schwarz	172050
<input type="checkbox"/> weiß	172051

Mitteleinspeiser

10A max.
Aluminium / Kunststoff
L: 15,7 cm B: 1,8 cm H: 1,8 cm
Gewicht: 0,39 kg
1 Stk.



Variante	Art. Nr.
<input checked="" type="checkbox"/> schwarz	172100
<input type="checkbox"/> weiß	172101

Flexverbinder

10A max.
Aluminium / Kunststoff
L: 29 cm B: 1,8 cm H: 1,8 cm
Gewicht: 0,12 kg
13,5 cm Kabellänge.
1 Stk.



Variante	Art. Nr.
<input checked="" type="checkbox"/> schwarz	172190
<input type="checkbox"/> weiß	172191

Endeinspeiser

10A max.
Aluminium / Stahl
L: 11,7 cm B: 8 cm H: 4 cm
Gewicht: 0,38 kg
1 Stk.



Variante	Art. Nr.
<input checked="" type="checkbox"/> schwarz	172060
<input type="checkbox"/> weiß	172061

Endkappe

Kunststoff
L: 1,1 cm B: 1,8 cm H: 1,8 cm
Gewicht: 0,01 kg
1 Stk.



Variante	Art. Nr.
<input checked="" type="checkbox"/> schwarz	172110
<input type="checkbox"/> weiß	172111

Seilabhängung

Aluminium / Stahl
L: 100 cm
Gewicht: 0,02 kg
1 Stk.



Variante	Art. Nr.
<input checked="" type="checkbox"/> schwarz	172200
<input type="checkbox"/> weiß	172201

Mitteleinspeiser

10A max.
Aluminium / Stahl
L: 15,5 cm B: 8 cm H: 4 cm
Gewicht: 0,26 kg
1 Stk.



Variante	Art. Nr.
<input checked="" type="checkbox"/> schwarz	172070
<input type="checkbox"/> weiß	172071

Alu-Abdeckung

Aluminium / Kunststoff
L: 100 cm B: 1,8 cm H: 0,2 cm
Gewicht: 0,06 kg
Inkl. 10 Befestigungsclips.
1 Stk.



Variante	Art. Nr.
<input checked="" type="checkbox"/> schwarz	172120
<input type="checkbox"/> weiß	172121

Adapter

2A max.
Aluminium / Kunststoff
L: 7 cm B: 1,9 cm H: 3,2 cm
Gewicht: 0,05 kg
Inkl. Zugentlastung für Pendelleuchten. Geeignet für Produkte mit M10 Gewinde.
1 Stk.



Variante	Art. Nr.
<input checked="" type="checkbox"/> schwarz	172220
<input type="checkbox"/> weiß	172221

Endeinspeiser

10A max.
Aluminium / Kunststoff
L: 9,4 cm B: 1,8 cm H: 1,8 cm
Gewicht: 0,25 kg
Inkl. Anschlussbox mit Zugentlastung
1 Stk.



Variante	Art. Nr.
<input checked="" type="checkbox"/> schwarz	172080
<input type="checkbox"/> weiß	172081

Linearverbinder

10A max.
Stahl / Kunststoff
L: 7 cm B: 1,5 cm H: 1,5 cm
Gewicht: 0,03 kg
1 Stk.



Variante	Art. Nr.
<input checked="" type="checkbox"/> grau	172134

BLEIBEN IN DER SPUR.

EINFACH GUT BELEUCHTET MIT
1PHASEN-HOCHVOLT-STROMSCHIENEN.

Die flache Schiene aus Aluminium lässt sich – dank der im Profil vorhandenen Bohrungen – schnell und unkompliziert an die Wand oder Decke anbringen. Dabei haben Sie die Wahl zwischen einer Einbauversion und einer Aufbauversion, die in mehreren Farben erhältlich sind.

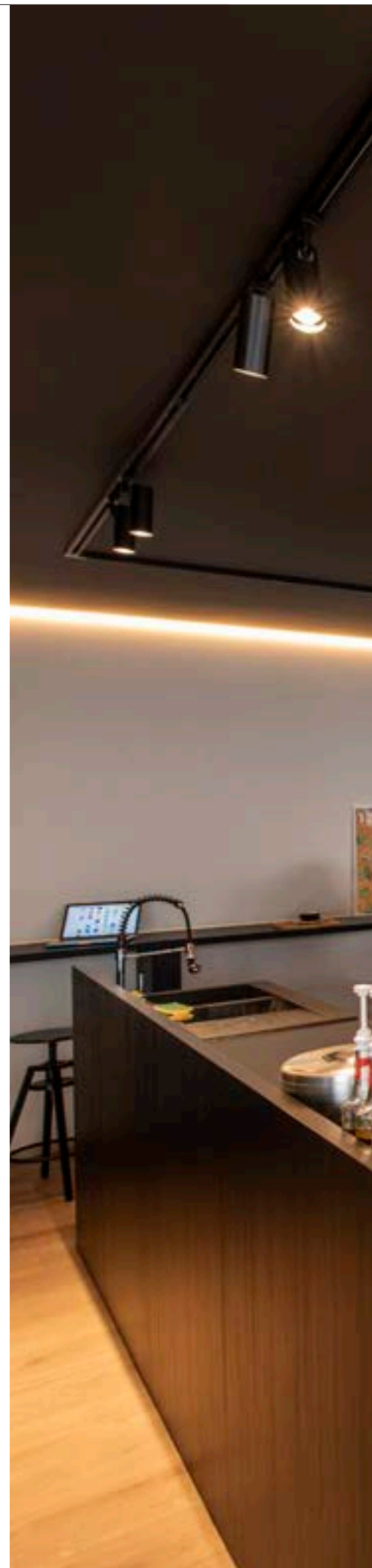

143580 397



1001862 396





1001868 387

HOCHVOLT-STROMSCHIENE 1PHASEN



Passende Einbau- und Aufbauschielen sowie Zubehör finden Sie auf den Sei en 402-405

Weitere Leuchten und Varianten finden Sie online un er www.slv.com

NOBLO SPOT
1Ph., Triple Track Set



A-A++ Spektrum
A++-E



NEW
VARIANT

LED
INSIDE

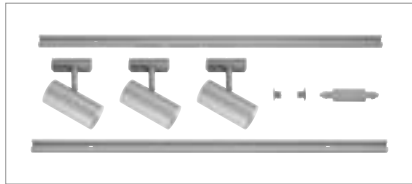

PURI TRACK
1Ph., Triple Track Set



E-A++ Spektrum
A+++-E

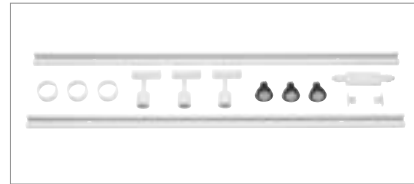

Produktangaben

220-240V ~50/60Hz | 350mA
Systemleistung: 22,5W
Material: Aluminium

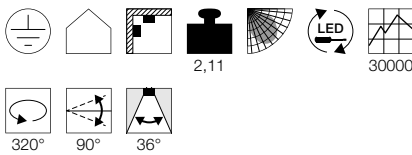

2,11

30000

Hinweis

Das Set besteht aus:

- 2x 1m Hochvoltschiene [143010/-1/-2]
- 1x Einspeiser/Längsverbinder [143100/-1/-2]
- 1x 2 Endkappen [143130/-1/-2]
- 3x Leuchtenkopf NOBLO [1001862/-3/-4]

Produktangaben

230V ~50Hz
Systemleistung: 12,9W
Material: Aluminium

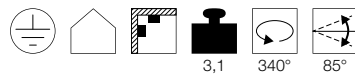

3,1

340°

85°

Hinweis

Das Set besteht aus:

- 2x 1m Hochvoltschiene
- 1x Längsverbinder
- 1x 2 Endkappen
- 3x Leuchtenkopf PURI
- 3x LED GU10 Leuchtmittel
- 3x Dekoring für GU10

Leuchtmittelangaben

3x 4,3W LED GU10 51mm

Variante	Art. Nr.
1860lm 2700K CRI>80 ■ schwarz	1002610
1860lm 2700K CRI>80 □ weiß	1002611
1860lm 2700K CRI>80 ■ grau	1002612

Variante	Art. Nr.
GU10 LED GU10 51mm ■ schwarz	143190
GU10 LED GU10 51mm □ weiß	143191
GU10 LED GU10 51mm ■ grau	143194

1002611 387



144201 387



1001868 387



PURIA TRACK
1Ph., QPAR51

E-A++ Spektrum A++-E



AVO TRACK
1Ph., QPAR51



E-A++ Spektrum A++-E



PURI TRACK
1Ph., QPAR51



E-A++ Spektrum A++-E



Produktangaben

230V ~50Hz
Material: Aluminium / Glas



0,18 340° 90°

Maßzeichnung

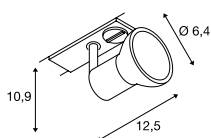

Produktangaben

230V ~50/60Hz
Material: Stahl



0,15 350° 85°

Maßzeichnung

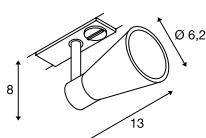

Produktangaben

230V ~50Hz
Material: Aluminium / Kunststoff



0,25 340° 85°

Maßzeichnung

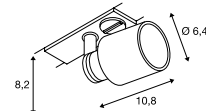

Leuchtmittlempfehlung

LED GU10 5,5W 38°
3000K 440lm EEK=A+
6kWh/1000h
Art. Nr. 551902



LED GU10 7W 25/40/55°
3000K 300lm EEK=A
7kWh/1000h
Art. Nr. 560603



Leuchtmittelangaben

max. 10W QPAR51

Variante	Art. Nr.
GU10 QPAR51	
■ matt schwarz	143450
GU10 QPAR51	
□ weiß / matt transparent	143451
GU10 QPAR51	
■ grau	143454

Leuchtmittlempfehlung

LED GU10 7,2W 36°
3000K 520lm EEK=A+
8kWh/1000h
Art. Nr. 1001563



LED GU10 5,5W 38°
2700K 400lm EEK=A+
6kWh/1000h
Art. Nr. 1001030



Leuchtmittelangaben

max. 50W QPAR51
Ø: 5 cm max.

Variante	Art. Nr.
GU10 QPAR51	
■ schwarz	144200
GU10 QPAR51	
□ weiß	144201
GU10 QPAR51	
■ grau	144204

Leuchtmittlempfehlung

LED GU10 5,5W 38°
2700K 400lm EEK=A+
6kWh/1000h
Art. Nr. 1001030



LED GU10 7,2W 36°
3000K 520lm EEK=A+
8kWh/1000h
Art. Nr. 1001562



Leuchtmittelangaben

max. 10W QPAR51

Variante	Art. Nr.
GU10 QPAR51	
■ schwarz	1001868
GU10 QPAR51	
□ weiß	1001869
GU10 QPAR51	
■ grau	1001870

PURI TRACK
1Ph., QPAR51



E-A++ Spektrum A++-E



SPOT TRACK
1Ph., E27



D-A+ Spektrum A++-E



LIGHT EYE® 90
1Ph., QPAR51



E-A++ Spektrum A++-E

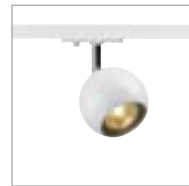

• Der optionale Dekoring für das Leuchtmittel in der passenden Farbe verringert den Abstand zwischen Gehäuse und Leuchtmittel

Produktangaben

230V ~50Hz
Material: Aluminium / Polycarbonat (PC)



Produktangaben

230V ~50Hz
Material: Aluminium

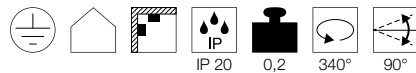

Produktangaben

230V ~50/60Hz
Material: Stahl

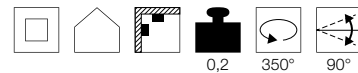

Maßzeichnung

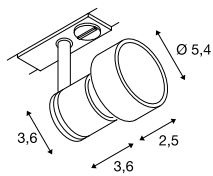

Maßzeichnung

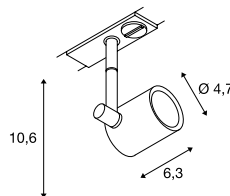

Maßzeichnung

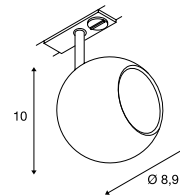

Leuchtmittlempfehlung

LED GU10 7,2W 36°
4000K 540lm EEK=A+
8kWh/1000h
Art. Nr. 1001565



LED GU10 7,2W 36°
2700K 520lm EEK=A+
8kWh/1000h
Art. Nr. 1001560



Leuchtmittelangaben

max. 50W QPAR51

Variante	Art. Nr.
GU10 QPAR51 ■ matt schwarz	143390
GU10 QPAR51 □ weiß	143391
GU10 QPAR51 ■ grau	143392

Leuchtmittlempfehlung

LED E27 11,5W 38°
3000K 760lm EEK=A+
12kWh/1000h
Art. Nr. 551933



LED E27 17W 45°
3000K 1430lm EEK=A+
17kWh/1000h
Art. Nr. 560473



Leuchtmittelangaben

max. 75W QPAR20
optional: QPAR30

Variante	Art. Nr.
E27 QPAR20 ■ schwarz	1001874
E27 QPAR20 □ weiß	1001875
E27 QPAR20 ■ grau	1001876

Zubehörempfehlung

- Leuchtmittel Dekoring Ø 5,7cm
Art. Nr. 151040
- Leuchtmittel Dekoring Ø 5,7cm
Art. Nr. 151041
- Leuchtmittel Dekoring Ø 5,7cm
Art. Nr. 151049



Leuchtmittlempfehlung

LED GU10 5,5W 38°
2700K 400lm EEK=A+
6kWh/1000h
Art. Nr. 1001030



LED GU10 7,2W 36°
2700K 520lm EEK=A+
8kWh/1000h
Art. Nr. 1001560



Leuchtmittelangaben

max. 50W QPAR51

Variante	Art. Nr.
GU10 QPAR51 ■ weiß / chrom	144011
GU10 QPAR51 ■ gold	144013
GU10 QPAR51 ■ kupfer	144019
GU10 QPAR51 ■ schwarz / chrom	144010

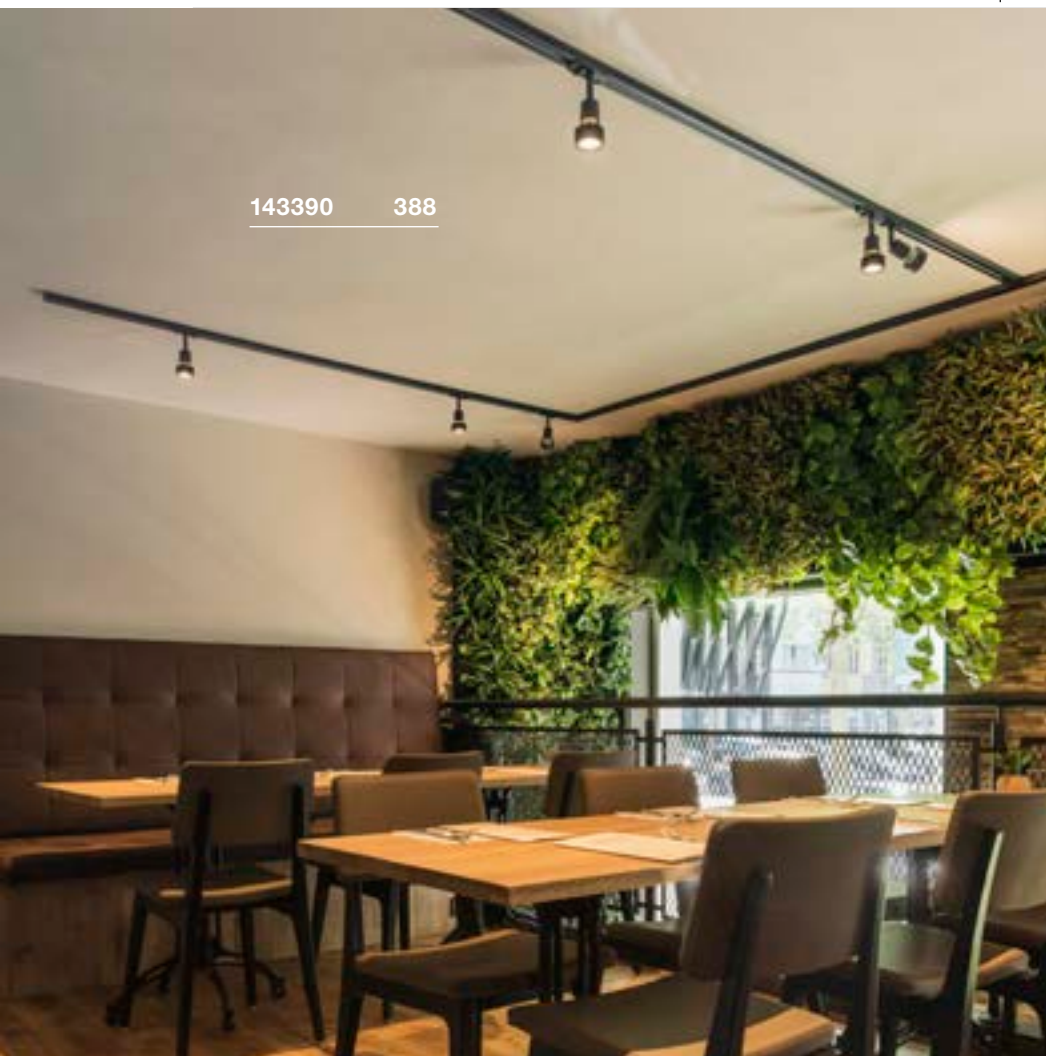

143390 388

PARA CONE 14

1Ph., QPAR51

 893

E-A++ Spektrum
A++-E



NEW
VARIANT



Produktangaben

220-240V ~50/60Hz
Material: Stahl

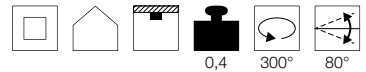

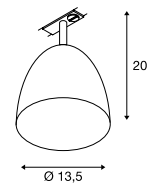

0,4 300° 80°

Maßzeichnung



Leuchtmittelangaben

max. 25W QPAR51

Variante	Art. Nr.
GU10 ■ glänzend schwarz	1002873 
GU10 □ glänzend weiß	1002874 
GU10 ■ kupfer	1002875 

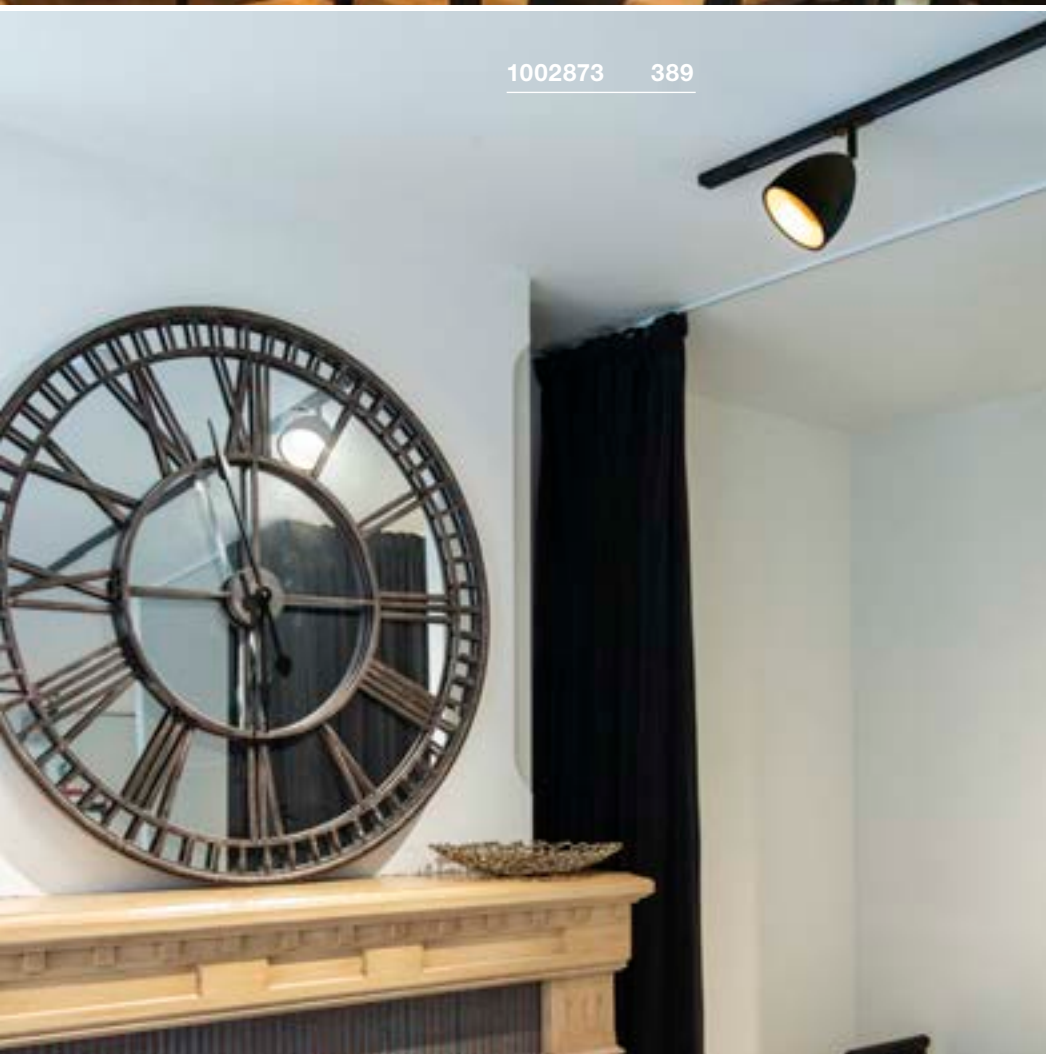

1002873 389

ENOLA B TRACK
1Ph., QPAR51



E-A++ Spektrum A++-E



1002113 390



Produktangaben

230V ~50/60Hz
Material: Aluminium / Stahl

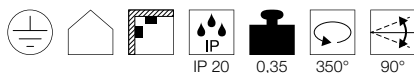

Maßzeichnung

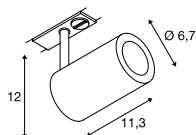

Leuchtmittlempfehlung

LED GU10 5,5W 38°
2700K 400lm EEK=A+
6kWh/1000h



Art. Nr. 1001030

LED GU10 7,2W 36°
3000K 520lm EEK=A+
8kWh/1000h



Art. Nr. 1001562

Leuchtmittelangaben

max. 50W QPAR51
Ø: 5 cm max. L: 6,7 cm max.

Variante	Art. Nr.
GU10 QPAR51	
■ schwarz	1002110
GU10 QPAR51	
□ weiß	1002111
GU10 QPAR51	
■ grau	1002113





143440 391



143430 391

BIMA
1Ph., single, QPAR51



E-A++ Spektrum A++-E



BIMA
1Ph., double, QPAR51



E-A++ Spektrum A++-E



Produktangaben

220-240V ~50/60Hz
Material: Aluminium



Produktangaben

220-240V ~50/60Hz
Material: Aluminium



Maßzeichnung

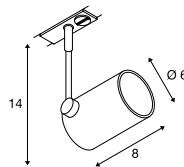

Maßzeichnung

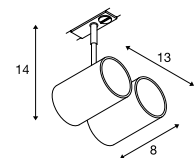

Leuchtmittlempfehlung

LED GU10 7,2W 36°
3000K 520lm EEK=A+
8kWh/1000h
Art. Nr. 1001563



LED GU10 5,5W 38°
2700K 400lm EEK=A+
6kWh/1000h
Art. Nr. 1001030



Leuchtmittlempfehlung

LED GU10 7,2W 36°
3000K 520lm EEK=A+
8kWh/1000h
Art. Nr. 1001563



LED GU10 7,2W 36°
4000K 540lm EEK=A+
8kWh/1000h
Art. Nr. 1001566



Leuchtmittelangaben

max. 50W QPAR51
Ø: 5 cm max. L: 5,7 cm max.

Variante	Art. Nr.
GU10 QPAR51	
■ matt schwarz	143440
□ GU10 QPAR51	
□ matt weiß	143441
GU10 QPAR51	
■ grau	143442

Leuchtmittelangaben

2x max. 50W QPAR51
Ø: 5 cm max. L: 5,7 cm max.

Variante	Art. Nr.
GU10 QPAR51	
■ matt schwarz	143430
□ GU10 QPAR51	
□ matt weiß	143431
GU10 QPAR51	
■ grau	143432

EURO SPOT TRACK
1Ph. QPAR51



E-A++ Spektrum
A++-E



EURO SPOT TRACK
1Ph.



A-A++ Spektrum
A++-E

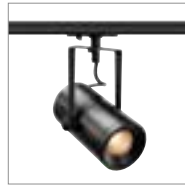

Produktangaben

230V ~50Hz
Material: Aluminium / Glas



0,47

350°

90°

Produktangaben

230V ~50Hz
Systemleistung: 11W
Material: Aluminium

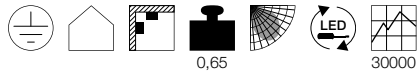

0,65

30000

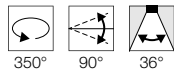

350°

90°

36°

Maßzeichnung

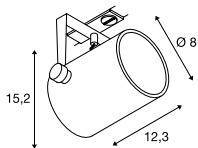

Maßzeichnung

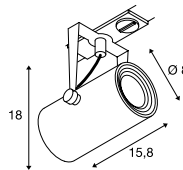

Leuchtmittlempfehlung

LED GU10 5,5W 38°
2700K 400lm EEK=A+
6kWh/1000h
Art. Nr. 1001030



LED GU10 5,1W 48°
2700-6500K 350lm EEK=A+
6kWh/1000h
Art. Nr. 1001918



Leuchtmittelangaben

max. 25W QPAR51

Variante	Art. Nr.
GU10 QPAR51	
■ schwarz	1001861
GU10 QPAR51	
□ weiß / transparent	143811
GU10 QPAR51	
■ grau	143814

Variante	Art. Nr.
650lm 3000K CRI>80	
■ schwarz	1001485
650lm 3000K CRI>80	
□ weiß	1001486
650lm 3000K CRI>80	
■ grau	1001487



1001485 392



1001486 392

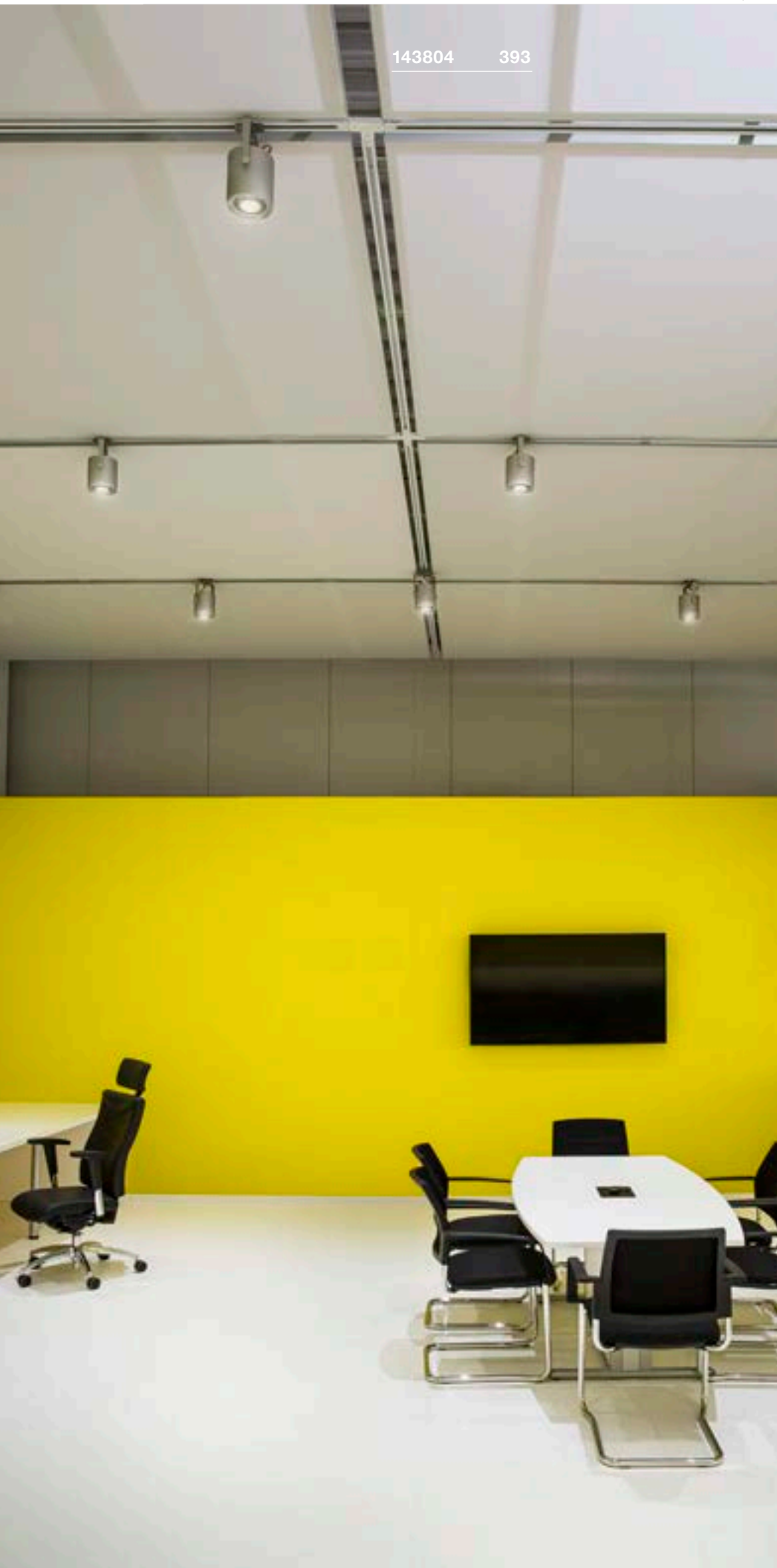

143804 393

EURO SPOT TRACK
1Ph. QPAR111
 886

E-A++

Spektrum
A++-E

Produktangaben

230V ~50Hz
Material: Aluminium



0,83

350°

90°

Maßzeichnung

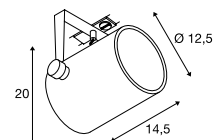

Leuchtmittlempfehlung

GU10 7W 13°
3000K 660lm EEK=A+
8kWh/1000h
Art. Nr. 1001568

LED GU10 13W 30°
2700K 1100lm EEK=A+
13kWh/1000h
Art. Nr. 1001242



Leuchtmittelangaben

max. 75W QPAR111

Variante	Art. Nr.
GU10 QPAR111	
■ schwarz	1001860
GU10 QPAR111	
□ weiß	143801
GU10 QPAR111	
■ grau	143804

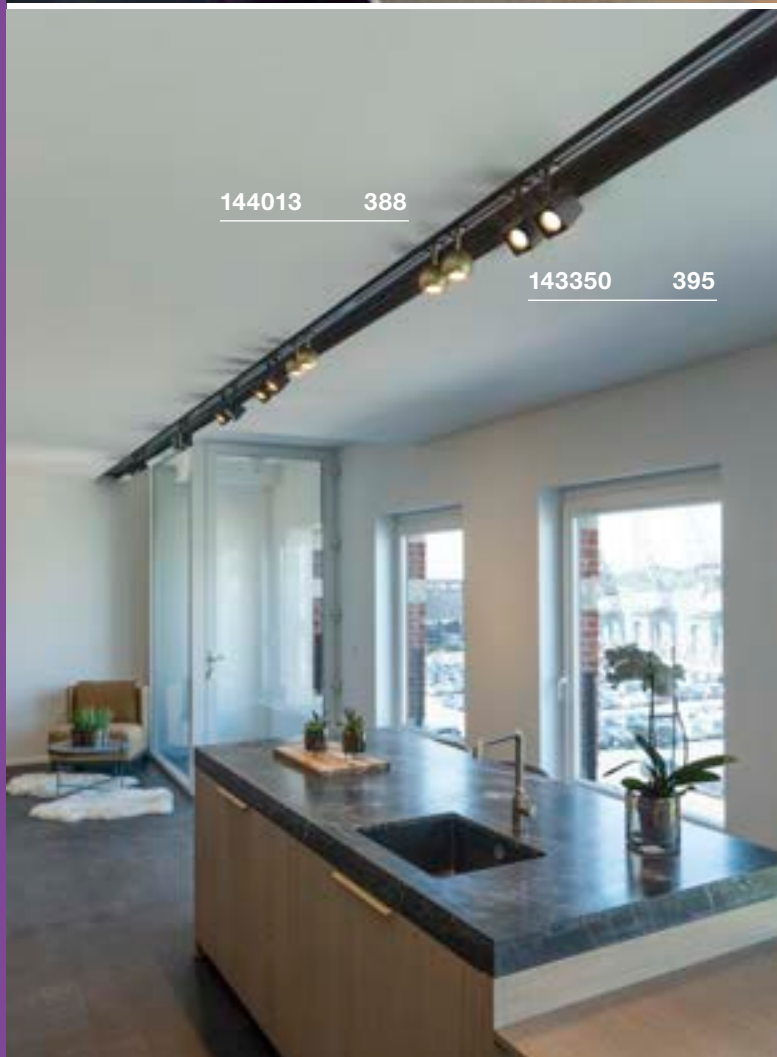
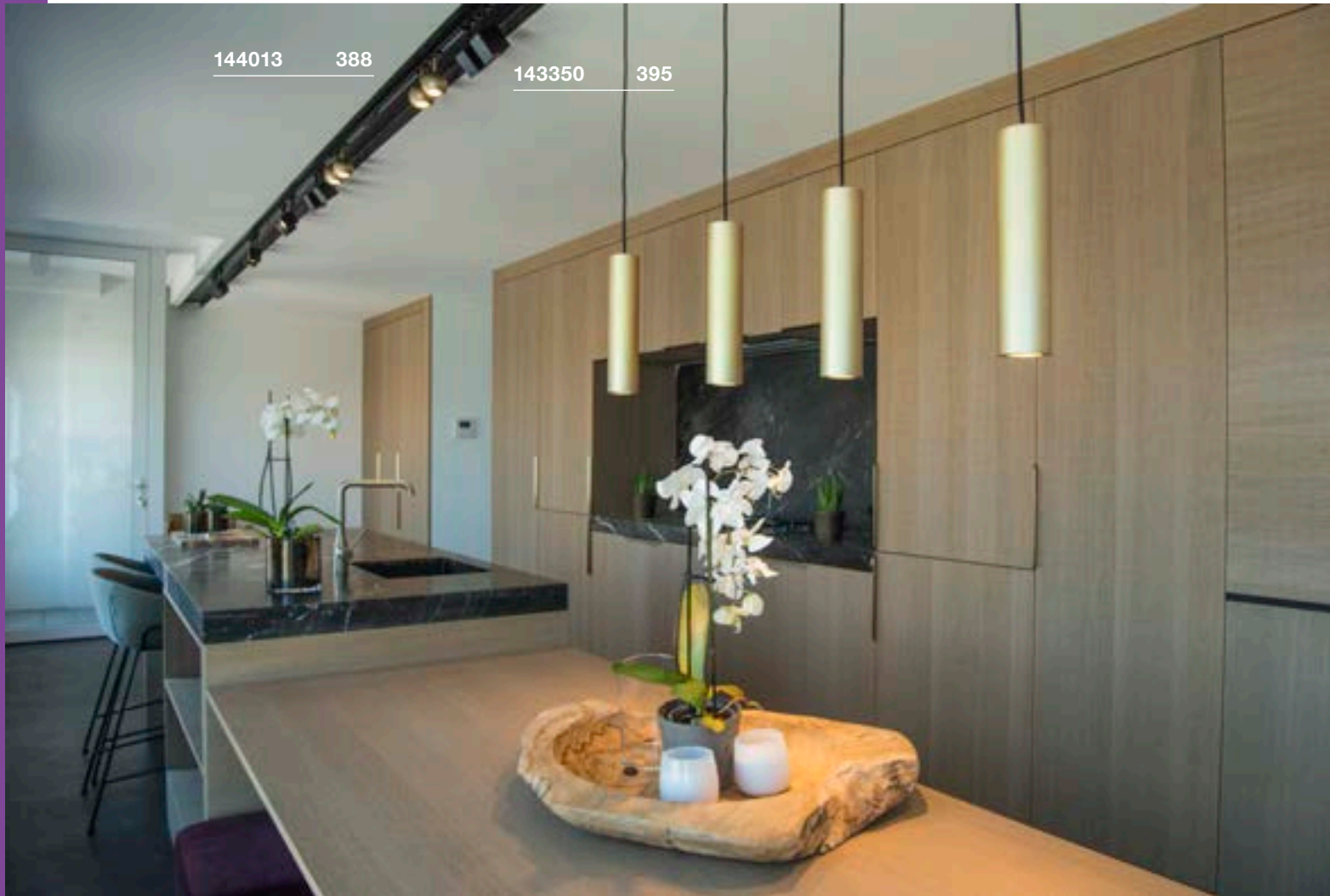

ALTRA DICE TRACK
1Ph., QPAR51



E-A++ Spektrum A++-E



Produktangaben

230V ~50/60Hz
Material: Aluminium



0,37

350° 180°

Maßzeichnung

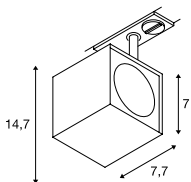

Leuchtmittlempfehlung

LED GU10 7,2W 36°
3000K 520lm EEK=A+
8kWh/1000h
Art. Nr. 1001563



LED GU10 5,5W 38°
2700K 400lm EEK=A+
6kWh/1000h
Art. Nr. 1001030



Leuchtmittelangaben

max. 50W QPAR51

Variante	Art. Nr.
GU10 QPAR51	
■ schwarz	143350
GU10 QPAR51	
□ weiß	143351
GU10 QPAR51	
■ grau	143354

KALU TRACK
1Ph., TRIAC



A-A++ Spektrum A++-E



Produktangaben

220-240V ~50/60Hz
Systemleistung: 13W
Material: Aluminium
Dimmbar: Triac C

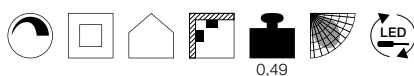

0,49

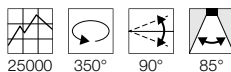

Maßzeichnung

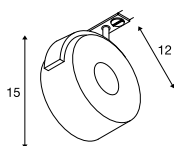

KALU TRACK
1Ph., QPAR111



E-A++ Spektrum A++-E



Produktangaben

230V ~50Hz
Material: Aluminium / Kunststoff



0,24

350° 90°

Maßzeichnung

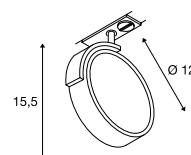

Leuchtmittlempfehlung

GU10 7,9W 25°
4000K 760lm EEK=A+
8kWh/1000h
Art. Nr. 560704



LED GU10 13W 30°
4000K 1300lm EEK=A+
13kWh/1000h
Art. Nr. 1001243



Leuchtmittelangaben

max. 75W QPAR111

Variante	Art. Nr.
GU10 QPAR111	
■ matt schwarz	143540
GU10 QPAR111	
□ weiß	143541
GU10 QPAR111	
■ grau	143544

NOBLO SPOT
1Ph.



A-A++ Spektrum
A++-E



1001863 396

Produktangaben

220-240V ~50/60Hz | 350mA
Systemleistung: 7,5W
Material: Aluminium

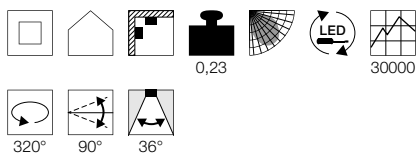

Maßzeichnung

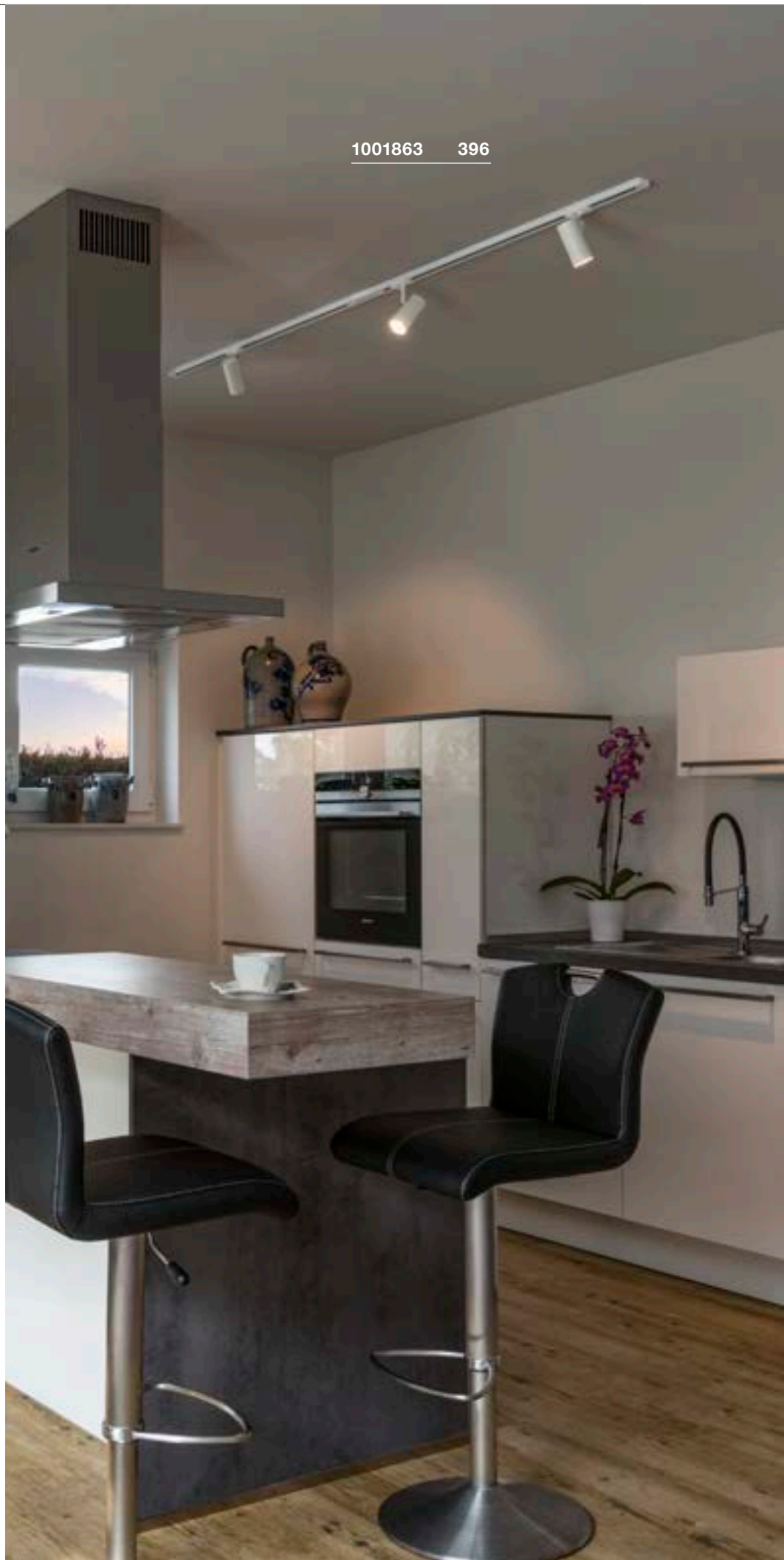
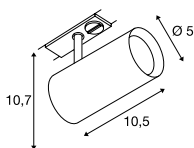

Variante	Art. Nr.
620lm 2700K CRI>80	
■ schwarz	1001862
620lm 2700K CRI>80	
□ weiß	1001863
620lm 2700K CRI>80	
■ grau	1001864



143580 397



1000712 397

HELIA 50 TRACK
1Ph.



A-A++ Spektrum A++-E



- Premium LED mit CRI>90

Produktangaben

220-240V ~50/60Hz | 500mA
Systemleistung: 11W
Material: Aluminium

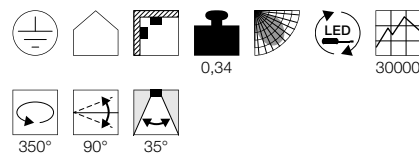

Maßzeichnung

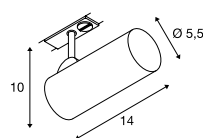

Variante	Art. Nr.
750lm 3000K CRI>90	
■ schwarz	143580
750lm 3000K CRI>90	
□ weiß	143581

ENOLA C TRACK
1Ph.



A-A++ Spektrum A++-E

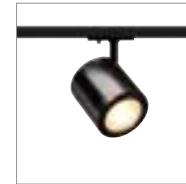

Produktangaben

220-240V ~50/60Hz | 500mA
Systemleistung: 11W
Material: Aluminium / Glas

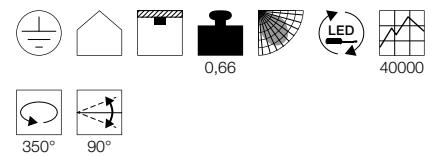

Maßzeichnung

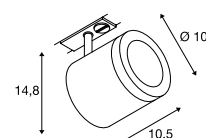

Variante	Art. Nr.
900lm 3000K CRI>80 35°	
■ schwarz	1000711
900lm 3000K CRI>80 35°	
□ weiß / transparent	143941
900lm 3000K CRI>80 55°	
■ schwarz	1000712
900lm 3000K CRI>80 55°	
□ weiß	143951

STRUCTEC
1Ph.



A-A++ Spektrum A++-E



- Premium LED mit CRI>90

Produktangaben

230V ~50/60Hz
Systemleistung: 28W
Material: Aluminium

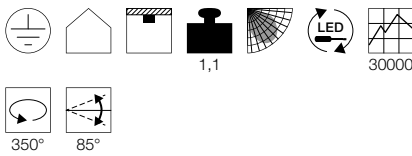

Maßzeichnung

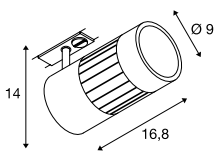

Variante	Art. Nr.
2700lm 3000K CRI>90 36° ■ schwarz	1000974
2700lm 3000K CRI>90 36° □ weiß	1000975
2700lm 3000K CRI>90 36° ■ grau	1000976
2650lm 3000K CRI>90 60° ■ schwarz	1000977
2650lm 3000K CRI>90 60° □ weiß	1000978
2650lm 3000K CRI>90 60° ■ grau	1000979

BILAS TRACK
1Ph., TRIAC



A-A++ Spektrum A++-E



- Hochvolt LED

Produktangaben

230V ~50/60Hz
Systemleistung: 16W
Material: Aluminium / Glas
Dimmbar: Triac C, Triac L

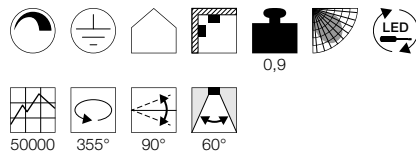

Maßzeichnung

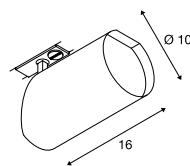

Variante	Art. Nr.
1000lm 2700K CRI>80 ■ matt schwarz	143560
1000lm 2700K CRI>80 □ matt weiß	143561



DESIGNED BY
Vincent de Smedt



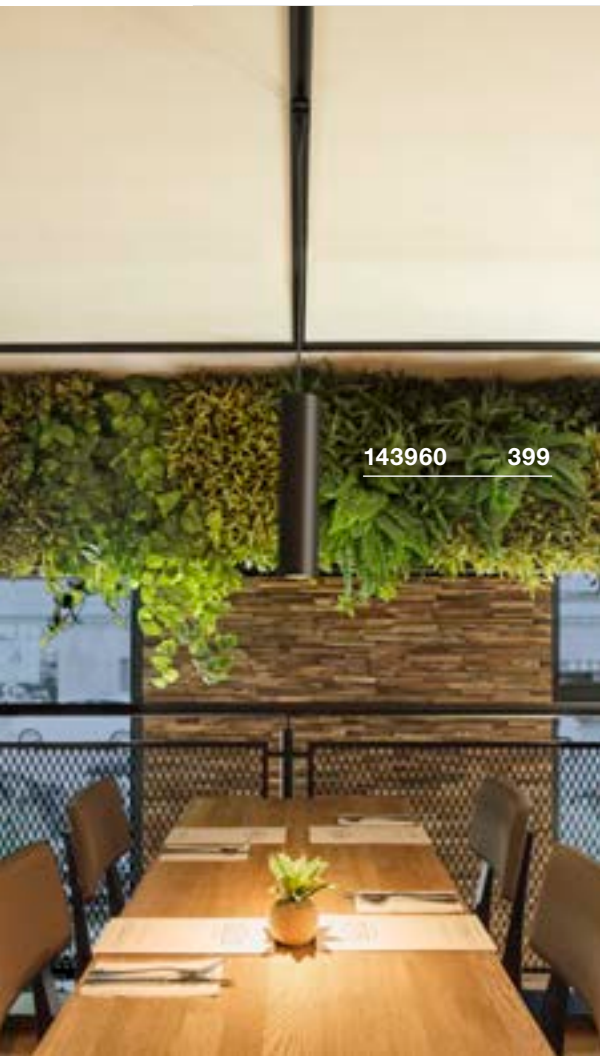

143960 399



1000713 399

ENOLA B
PD, QPAR51



E-A++ Spektrum A++-E



LIGHT EYE® 150
PD, QPAR111



E-A++ Spektrum A++-E

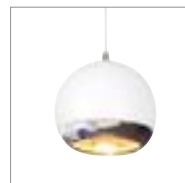

Produktangaben

230V ~50Hz
Material: Aluminium / Stahl

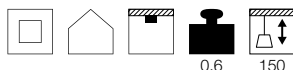

Produktangaben

230V ~50Hz
Material: Stahl

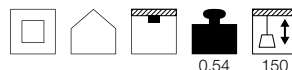

Maßzeichnung

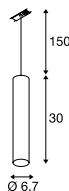

Maßzeichnung

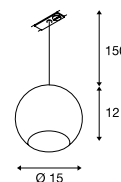

Leuchtmittlempfehlung

LED GU10 7,2W 36°
3000K 520lm EEK=A+
8kWh/1000h
Art. Nr. 1001563



LED GU10 7W 25/40/55°
3000K 300lm EEK=A
7kWh/1000h
Art. Nr. 560603



Leuchtmittelangaben

max. 50W QPAR51

Variante	Art. Nr.
GU10 QPAR51	
■ schwarz	143960
□ weiß	143961
■ grau	143964

Zubehörempfehlung

■ Deckenhaken
Art. Nr. 132670



□ Deckenhaken
Art. Nr. 132671



■ Kabelhaken
Art. Nr. 132680



□ Kabelhaken
Art. Nr. 132681



Leuchtmittlempfehlung

LED GU10 13W 30°
2700K 1100lm EEK=A+
13kWh/1000h
Art. Nr. 1001242



LED GU10 13W 140°
2700K 1000lm EEK=A+
13kWh/1000h
Art. Nr. 1001244



Leuchtmittelangaben

max. 75W QPAR111

Variante	Art. Nr.
GU10 QPAR111	
■ schwarz / chrom	1000713
■ chrom	143620
■ weiß / chrom	143621

PARA CONE 14
1Ph., PD, QPAR51



E-A++ Spektrum A++-E

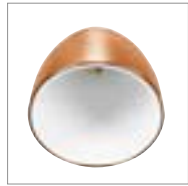
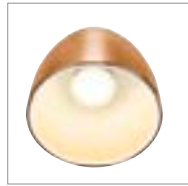

- Durch individuelle Zusammenstellung zur Leuchtenwolke kombinierbar

Produktangaben

230V ~50Hz
Material: Aluminium

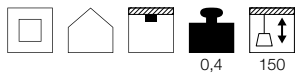

Maßzeichnung

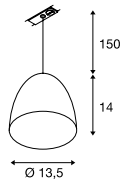

Leuchtmittlempfehlung

LED GU10 7,2W 36°
3000K 520lm EEK=A+
8kWh/1000h
Art. Nr. 1001563



LED GU10 5,5W 38°
2700K 400lm EEK=A+
6kWh/1000h
Art. Nr. 1001030



Leuchtmittelangaben

max. 35W QPAR51

Variante	Art. Nr.
GU10 QPAR51	
■ glänzend schwarz	143990
GU10 QPAR51	
□ weiß	143991
GU10 QPAR51	
■ kupfer	1001968

TONGA®
1Ph., PD, E14



E-A++ Spektrum A++-E



- Keramikschild

Produktangaben

220-240V ~50/60Hz
Material: Aluminium / Glas

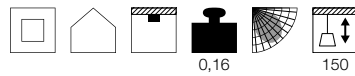

Maßzeichnung

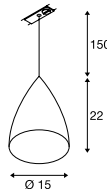

Leuchtmittlempfehlung

E14 3,4W 260°
3000K 250lm EEK=A+
4kWh/1000h
Art. Nr. 560362



LED E14 6,5W 280°
3000K 480lm EEK=A+
7kWh/1000h
Art. Nr. 560372



Leuchtmittelangaben

max. 60W C35
Ø: 5 cm max. L: 13 cm max.

Variante	Art. Nr.
E14 C35	
■ grau / glänzend milchig	143594



1001968 400



143594 400



143930 401

FORCHINI M 40 TRACK 1Ph., E27

887

E-A++ Spektrum
A++-E

- Doppelwandige Konstruktion mit innenliegendem Reflekt
- Textilkabel in Gehäusefarbe

Produktangaben

230V ~50Hz
Material: Aluminium / Stahl



1,52

150

Maßzeichnung

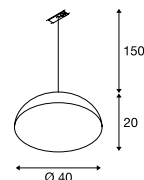

Hinweis

Pendelleuchten-Adapter Farbe silbergrau [143930] / weiß [143931] / schwarz [143932]

Leuchtmittlempfehlung

LED E27 7W 330°
2700K 806lm EEK=A+
8kWh/1000h

Art. Nr. 1001035



LED E27 7W 280°
2200-2700K 830lm EEK=A++
7kWh/1000h

Art. Nr. 1002126



Leuchtmittelangaben

max. 40W A60
Ø: 6,8 cm max. L: 15,2 cm max.

Variante	Art. Nr.
E27 A60 ■ schwarz / gold	143930
E27 A60 ■ weiß / gold	143931
E27 A60 ■ schwarz / gold	143932



143931 401

EINBAUSCHIENE 2 M

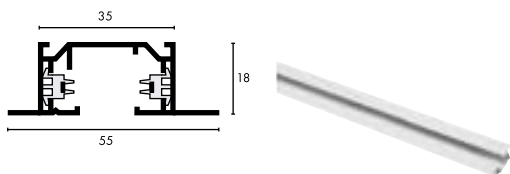

1PHASEN-EINBAUSCHIENE



Bemessungsspannung	230V ~50Hz/60Hz
Strombelastung max.	16A
Einspeisemöglichkeit	nein
Material	Aluminium
Farbe	weiß
Länge	200 cm
Breite	5,5 cm
Höhe	1,8 cm
Einbaubreite	4 cm
Gewicht	1,16 kg

Art. Nr.	143221
-----------------	---------------



Deckenabhängung

Edelstahl / Messing
L: 500 cm
Gewicht: 0,2 kg
2 Stk.

Variante	Art. Nr.
■ nickel	1002845

Eck-Verbinder, Erde außen

16A max.
Kunststoff
L: 11,2 cm B: 11,2 cm H: 2 cm
Gewicht: 0,07 kg
Erde außen
1 Stk.

Variante	Art. Nr.
□ weiß	143251

Abdeckung

Kunststoff
L: 100 cm B: 1,8 cm
Gewicht: 0,04 kg
1 Stk.

Variante	Art. Nr.
□ weiß	143291

Halterbügel

Stahl
L: 7,5 cm B: 1,5 cm H: 4 cm
Gewicht: 0,03 kg
Benötigt zur Verstärkung bei Montage mehrere Schienen der Längsverbinder inkl. Stabilisator (143271). Optional zur Verstärkung bei Eckmontage der Stabilisator Eckverbinder lang (143152)
1 Stk.

Variante	Art. Nr.
■ matt nickel	143230

Eck-Verbinder, Erde innen

16A max.
Kunststoff
L: 11,2 cm B: 11,2 cm H: 2 cm
Gewicht: 0,07 kg
Erde innen
1 Stk.

Variante	Art. Nr.
□ weiß	143261

Stabilisator, Eckverbinder lang

Stahl
L: 11,5 cm B: 11,5 cm H: 0,5 cm
Gewicht: 0,06 kg
Zur Verstärkung bei Montage mehrerer Schienen mit Deckenabhängung (143140/-1/-2)
1 Stk.

Variante	Art. Nr.
■ matt nickel	143152

Einspeiser, Erde links

16A max.
Kunststoff
L: 10,8 cm B: 5,5 cm H: 2 cm
Gewicht: 0,41 kg
Erde links
1 Stk.

Variante	Art. Nr.
□ weiß	143231

Längsverbinder inkl. Längsversteifer

Kunststoff / Stahl
L: 6,5 cm B: 1,8 cm H: 1,7 cm
Gewicht: 0,09 kg
Der Verbinder wird in der Schiene montiert, der Stabilisator auf der Rückseite der Schiene.
1 Stk.

Variante	Art. Nr.
□ weiß	143271

1Ph-Adapter mit Haken

6A max.
Polycarbonat (PC)
L: 8,2 cm B: 3,5 cm H: 7,4 cm
Gewicht: 0,05 kg
Für Pendelleuchten, die über eine zusätzliche mechanische Abhängung verfügen. Max. mechanische Belastung 20N.
1 Stk.

Variante	Art. Nr.
■ schwarz	143170
□ weiß	143171
■ grau	143172

Einspeiser, Erde rechts

16A max.
Kunststoff
L: 10,8 cm B: 5,5 cm H: 2 cm
Gewicht: 0,41 kg
Erde rechts
1 Stk.

Variante	Art. Nr.
□ weiß	143241

Endkappe, 2 Stk.

Kunststoff
L: 2,7 cm B: 5,5 cm H: 1,8 cm
Gewicht: 0,01 kg
2 Stk.

Variante	Art. Nr.
□ weiß	143281

Pendelleuchtenadapter

6A max.
Polycarbonat (PC)
L: 8,2 cm B: 3,5 cm H: 4,2 cm
Gewicht: 0,04 kg. Inkl. Zugentlastung.
Max. mechanische Belastung 20N.
1 Stk.

Variante	Art. Nr.
■ schwarz	143120
□ weiß	143121
■ grau	143124

PLANUNGSHILFE 1PHASEN-AUFBAUSCHIENE

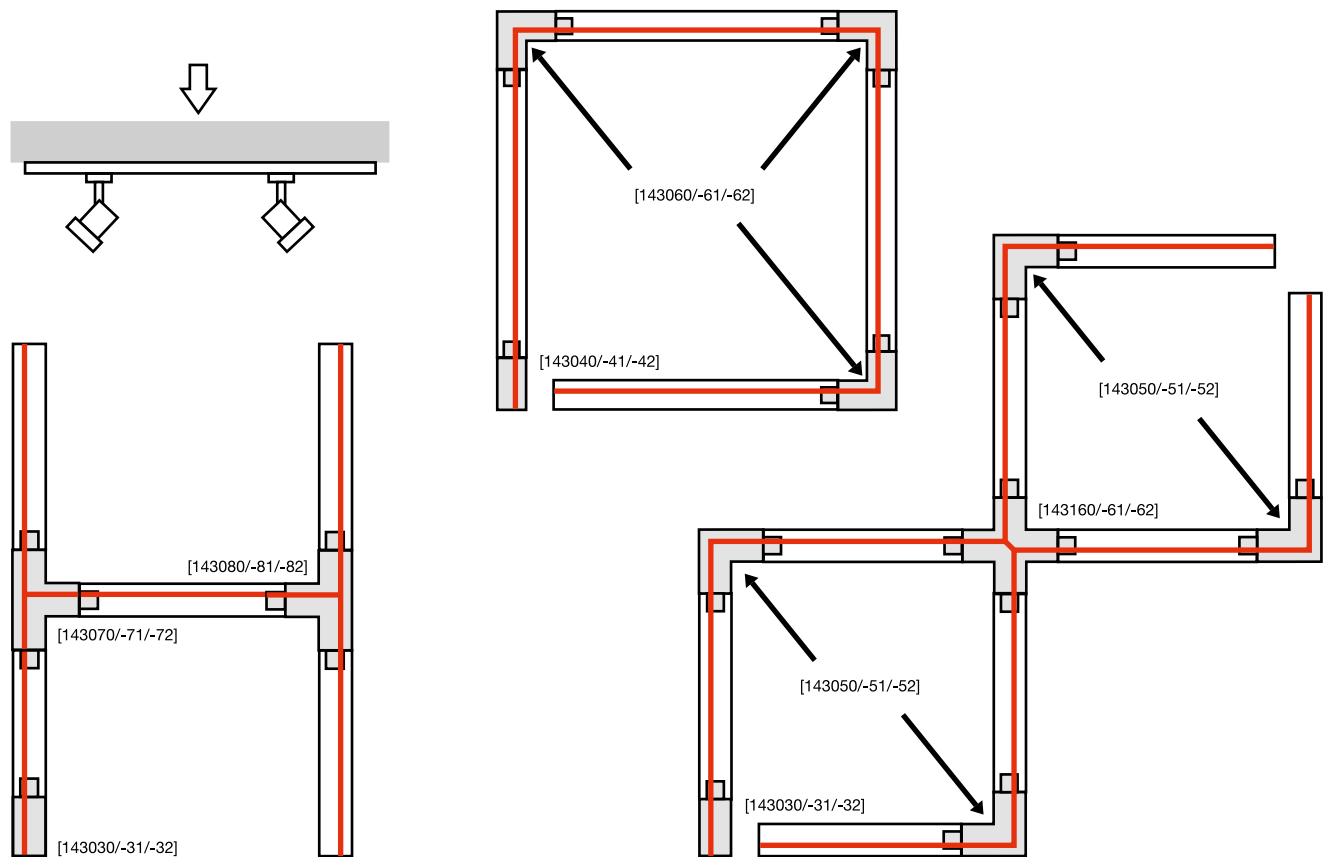

AUFBAUSCHIENEN 1 M



1PHASEN-AUFBAUSCHIENE

1PHASEN-AUFBAUSCHIENE

1PHASEN-AUFBAUSCHIENE

Bemessungsspannung	220-240V ~50/60Hz	220-240V ~50/60Hz	220-240V ~50Hz
Strombelastung max.	16A	16A	16
Einspeisemöglichkeit	nein	nein	nein
Material	Aluminium	Aluminium	Aluminium
Farbe	matt schwarz	weiß	grau
Länge	100 cm	100 cm	100 cm
Breite	3,5 cm	3,5 cm	3,5 cm
Höhe	1,8 cm	1,8 cm	1,8 cm
Gewicht	0,67 kg	0,67 kg	0,67 kg
Art. Nr.	143010	143011	143012

AUFBAUSCHIENEN 2 M



1PHASEN-AUFBAUSCHIENE

1PHASEN-AUFBAUSCHIENE

1PHASEN-AUFBAUSCHIENE

Bemessungsspannung	220-240V ~50/60Hz	220-240V ~50Hz	220-240V ~50/60Hz
Strombelastung max.	16A	16A	16A
Einspeisemöglichkeit	nein	nein	nein
Material	Aluminium	Aluminium	Aluminium
Farbe	matt schwarz	weiß	grau
Länge	200 cm	200 cm	200 cm
Breite	3,5 cm	3,5 cm	3,5 cm
Höhe	1,8 cm	1,8 cm	1,8 cm
Gewicht	1,34 kg	1,34 kg	1,34 kg
Art. Nr.	143020	143021	143022

AUFBAUSCHIENEN 3 M



1PHASEN-AUFBAUSCHIENE

1PHASEN-AUFBAUSCHIENE

1PHASEN-AUFBAUSCHIENE

Bemessungsspannung	230V ~50Hz/60Hz	230V ~50Hz/60Hz	230V ~50Hz/60Hz
Strombelastung max.	16A	16A	16A
Einspeisemöglichkeit	nein	nein	nein
Material	Aluminium	Aluminium	Aluminium
Farbe	schwarz	weiß	grau
Länge	300 cm	300 cm	300 cm
Breite	3,5 cm	3,5 cm	3,5 cm
Höhe	1,8 cm	1,8 cm	1,8 cm
Gewicht	1,6 kg	1,6 kg	1,6 kg
Art. Nr.	1002151	1002152	1002153

ZUBEHÖR 1PHASEN-AUFBAUSCHIENE

Deckenabhängung

Edelstahl / Messing
L: 500 cm
Gewicht: 0,2 kg
2 Stk.



Variante	Art. Nr.
■ nickel	1002845

Längsverbinder, elektrisch

16A max.
Polycarbonat (PC)
L: 6,4 cm B: 3,5 cm H: 1,8 cm
Gewicht: 0,02 kg
1 Stk.



Variante	Art. Nr.
■ schwarz	143090
□ weiß	143091
■ grau	143092

Endkappe, 2 Stk.

Polycarbonat (PC)
L: 0,4 cm B: 3,5 cm H: 1,8 cm
Gewicht: 0,01 kg
2 Stk.



Variante	Art. Nr.
■ schwarz	143130
□ weiß	143131
■ grau	143132

Einspeiser, Erde links

16A max.
Polycarbonat (PC)
L: 10,4 cm B: 3,5 cm H: 1,8 cm
Gewicht: 0,04 kg
Erde links
1 Stk.



Variante	Art. Nr.
■ schwarz	143030
□ weiß	143031
■ grau	143032

Längverbinder mit Einspeisemöglichkeit

16A max.
Polycarbonat (PC)
L: 17,2 cm B: 3,5 cm H: 1,8 cm
Gewicht: 0,07 kg
1 Stk.



Variante	Art. Nr.
■ schwarz	143100
□ weiß	143101
■ grau	143102

X-Verbinder

16A max.
Polycarbonat (PC)
L: 9,5 cm B: 17,2 cm H: 1,8 cm
Gewicht: 0,13 kg
1 Stk.



Variante	Art. Nr.
■ schwarz	143160
□ weiß	143161
■ grau	143162

Einspeiser, Erde rechts

16A max.
Polycarbonat (PC)
L: 10,4 cm B: 3,5 cm H: 1,8 cm
Gewicht: 0,04 kg
Erde rechts
1 Stk.



Variante	Art. Nr.
■ schwarz	143040
□ weiß	143041
■ grau	143042

T-Verbinder, Erde links

16A max.
Polycarbonat (PC)
L: 17,2 cm B: 10,4 cm H: 1,8 cm
Gewicht: 0,1 kg
Erde links
1 Stk.



Variante	Art. Nr.
■ schwarz	143070
□ weiß	143071
■ grau	143072

Stabilisator, X-Verbinder

Stahl
L: 19,7 cm B: 19,7 cm H: 0,5 cm
Gewicht: 0,11 kg
Zur Verstärkung bei Montage
mehrerer Schienen mit Decken-
abhängung (143140/-1/-2).
1 Stk.



Variante	Art. Nr.
■ grau	143169

Eck-Verbinder, Erde außen

16A max.
Polycarbonat (PC)
L: 10,4 cm B: 10,4 cm H: 1,8 cm
Gewicht: 0,07 kg
Erde außen
1 Stk.



Variante	Art. Nr.
■ schwarz	143050
□ weiß	143051
■ grau	143052

T-Verbinder, Erde rechts

16A max.
Polycarbonat (PC)
L: 17,2 cm B: 10,4 cm H: 1,8 cm
Gewicht: 0,1 kg
Erde rechts
1 Stk.



Variante	Art. Nr.
■ schwarz	143080
□ weiß	143081
■ grau	143082

Stabilisator, Längsverbinder lang

Stahl
L: 19,7 cm B: 3,2 cm H: 1,3 cm
Gewicht: 0,08 kg
Zur Verstärkung bei Montage
mehrerer Schienen mit Decken-
abhängung (143141/-2)
1 Stk.



Variante	Art. Nr.
■ matt nickel	143151

Eck-Verbinder, Erde innen

16A max.
Polycarbonat (PC)
L: 10,4 cm B: 10,4 cm H: 1,8 cm
Gewicht: 0,07 kg
Erde innen
1 Stk.



Variante	Art. Nr.
■ schwarz	143060
□ weiß	143061
■ grau	143062

Flexverbinder

16A max.
Polycarbonat (PC)
L: 16,4 cm B: 3,5 cm H: 1,8 cm
Gewicht: 0,1 kg
1 Stk.



Variante	Art. Nr.
■ schwarz	143110
□ weiß	143111
■ grau	143112

Deckenrosette

6A max.
Polycarbonat (PC)
Ø: 12,1 cm H: 2,5 cm
Gewicht: 0,1 kg
1 Stk.



Variante	Art. Nr.
■ schwarz	143380
□ weiß	143381
■ grau	143382

1Ph. Pendelleuchtenadapter

6A max.
Kunststoff P
L: 8,2 cm B: 3,5 cm H: 4,2 cm
Max. mechanische Belastung 20N.
1 Stk.



Variante	Art. Nr.
■ schwarz	143120
□ weiß	143121
■ grau	143124



SCHWUNGVOLL UND CHIC.

DAS DEKORATIVE EASYTEC® II
HOCHVOLT-SCHIENEN-SYSTEM.

Mit dem dekorativen Schienensystem können Sie in wenigen Schritten eine individuelle Lichtstimmung erzeugen. Die Trägerschienen aus Aluminium sind in verschiedenen Farben erhältlich und so ideal auf Ihre Raumumgebung abstimmbare.





184450 411

184440 411



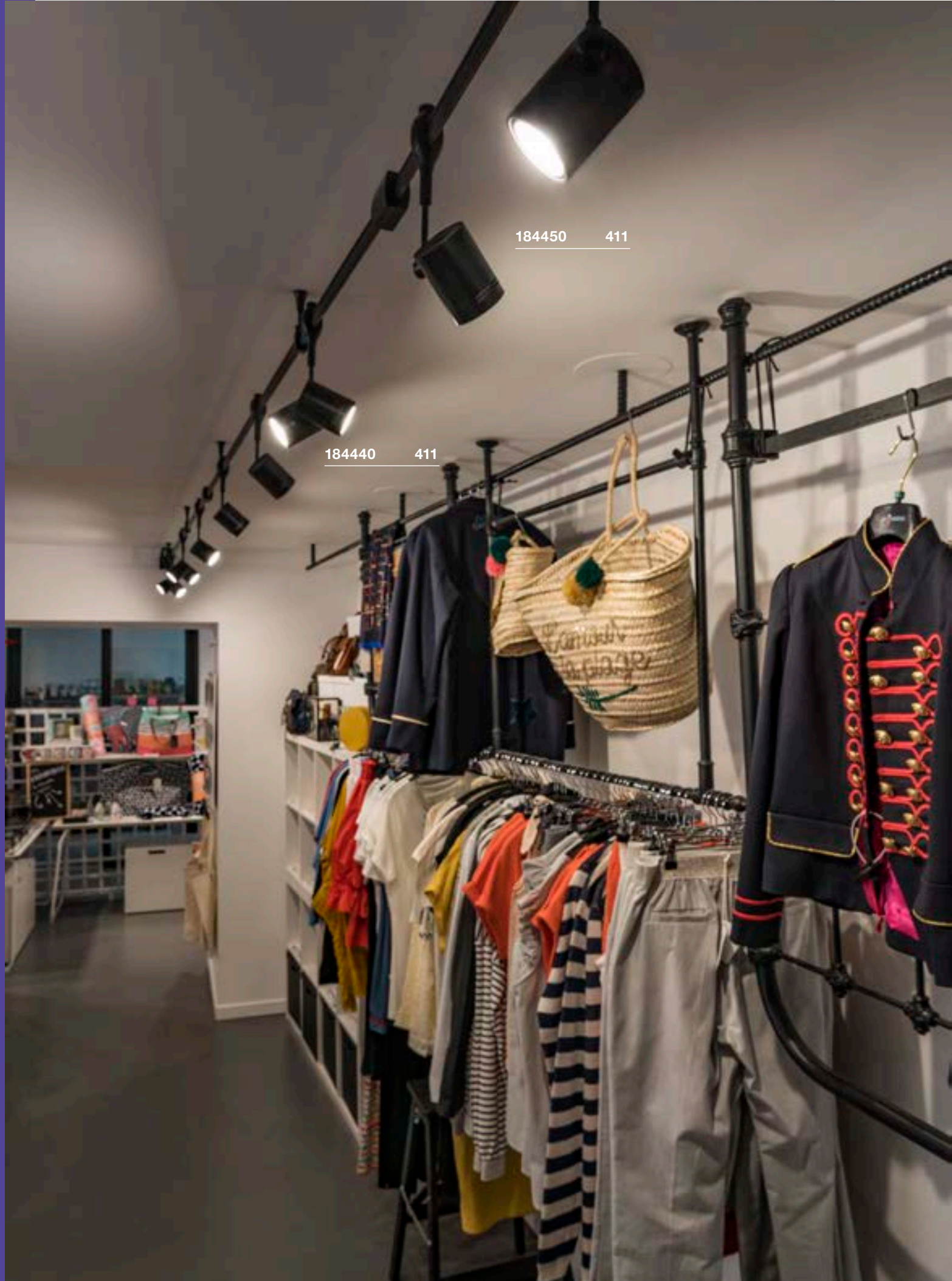

184450 411

184440 411

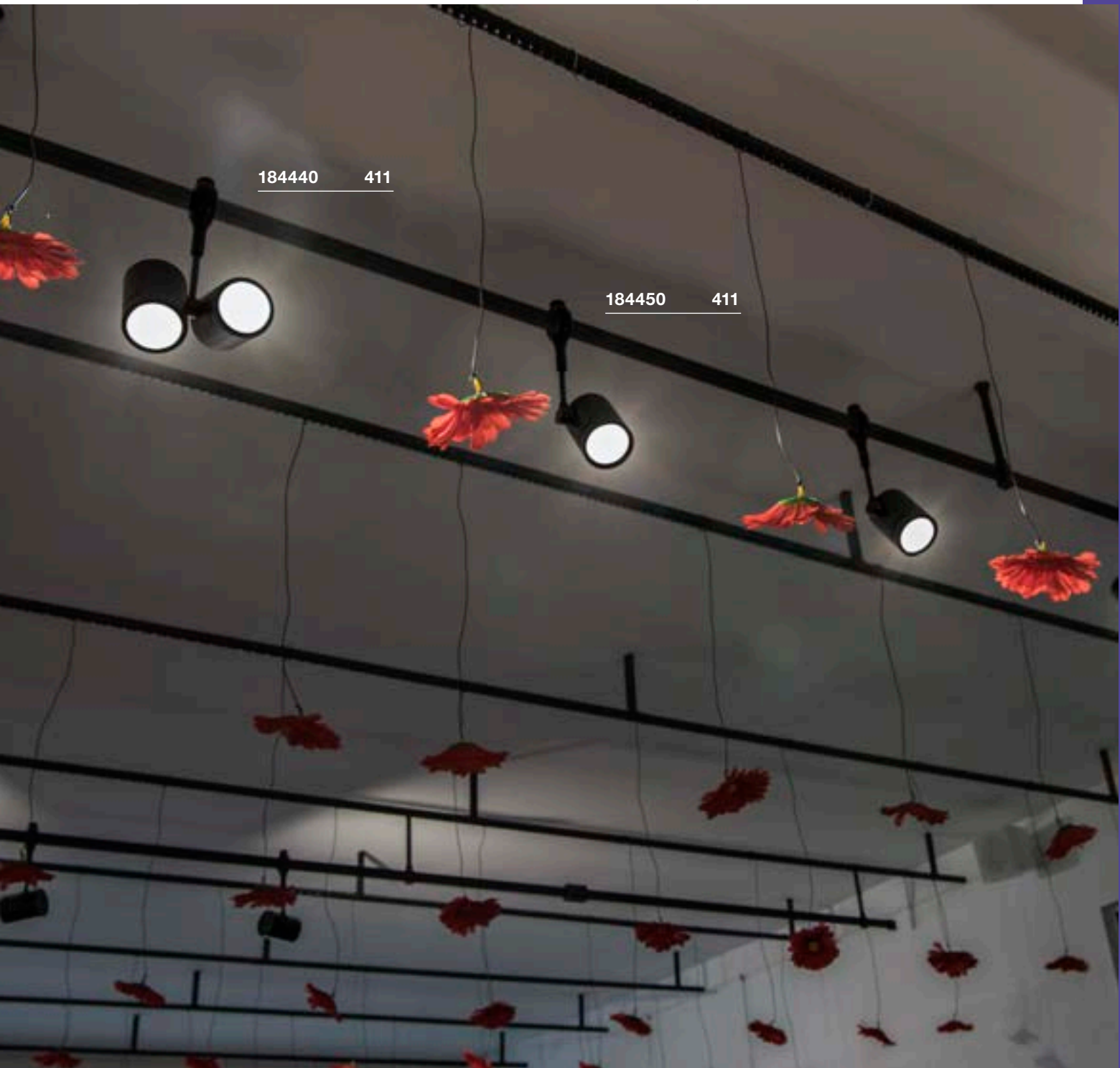

184440 411

184450 411

HOCHVOLT-STROMSCHIENE EASYTEC® II



Passende Stromschienen und Zubehör finden Sie auf der Seite 415



Weitere Leuchten und Varianten finden Sie online unter www.slv.com

HELIA 50 TRACK
EASYTEC® II



A-A++ Spektrum
A++-E



- Premium LED mit CRI>90

Produktangaben

220-240V ~50/60Hz | 500mA
Systemleistung: 11W
Material: Aluminium

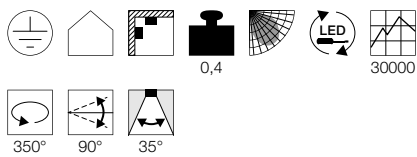

Maßzeichnung

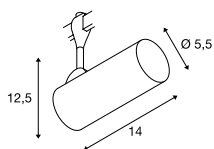

185450 411

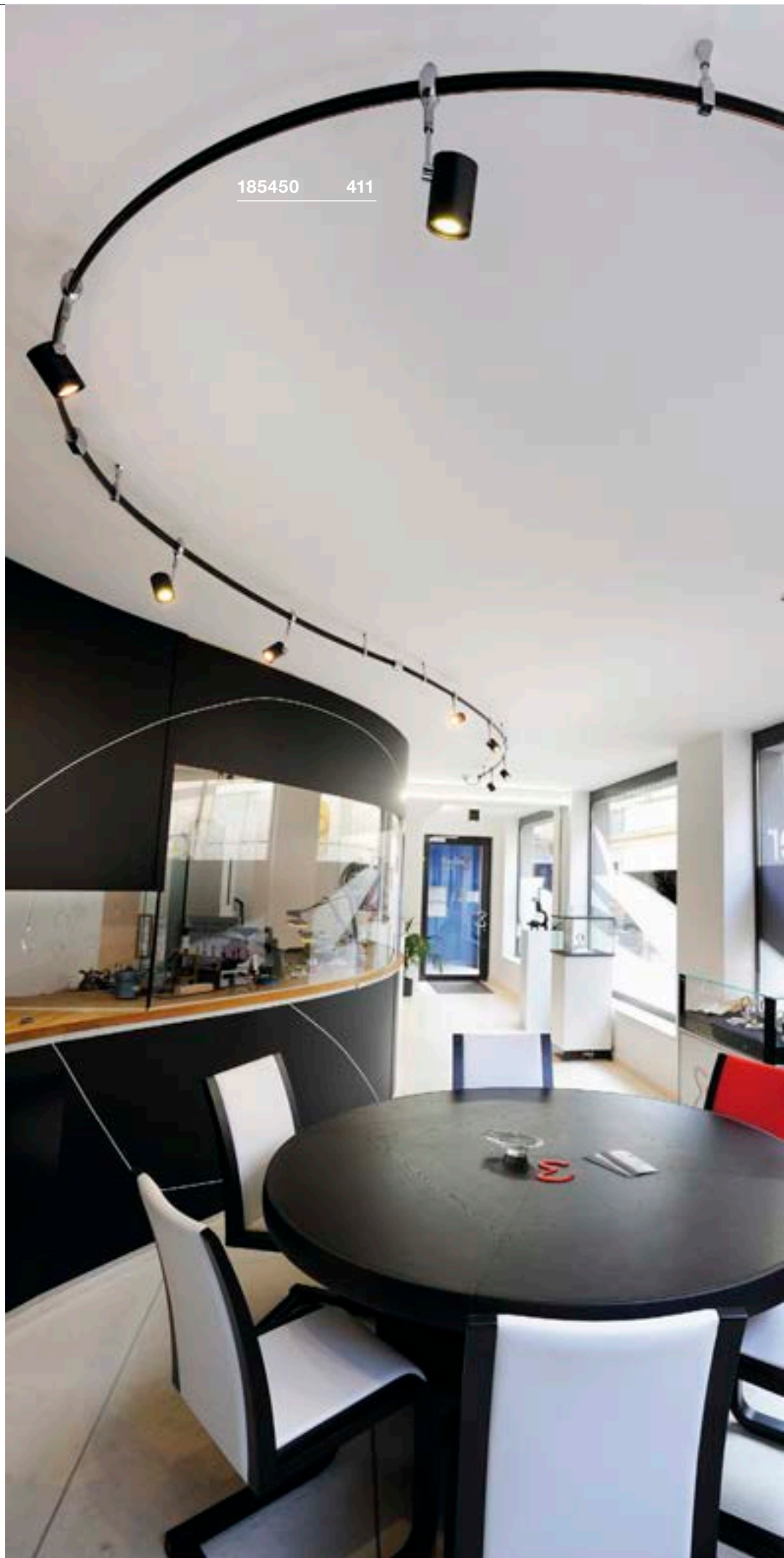

Variante	Art. Nr.
750lm 3000K CRI>90 ■ schwarz	184560

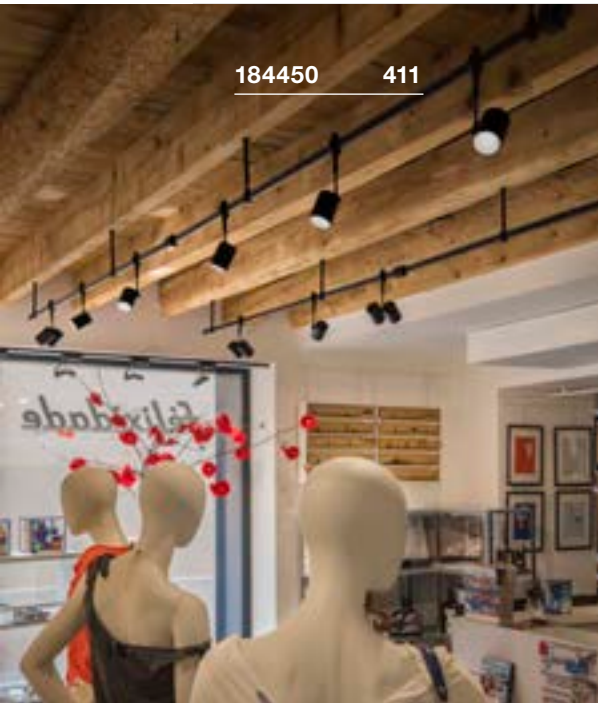

184450 411



184450 411



184440 411

BIMA
EASYTEC® II, single, QPAR51



E-A++ Spektrum A++-E



Produktangaben

220-240V ~50/60Hz
Material: Aluminium

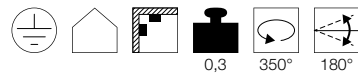

0,3 350° 180°

Maßzeichnung

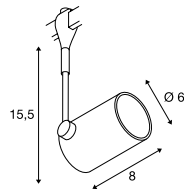

BIMA 2
EASYTEC® II, double, QPAR51



E-A++ Spektrum A++-E



Produktangaben

220-240V ~50/60Hz
Material: Aluminium

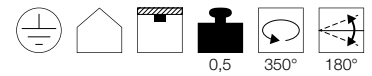

0,5 350° 180°

Maßzeichnung

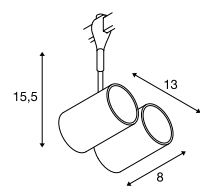

Leuchtmittlempfehlung

LED GU10 7,2W 36°
3000K 520lm EEK=A+
8kWh/1000h
Art. Nr. 1001563



LED GU10 5,5W 38°
2700K 400lm EEK=A+
6kWh/1000h
Art. Nr. 1001030



Leuchtmittelangaben

max. 50W QPAR51
Ø: 5,1 cm max. L: 5,7 cm max.

Variante	Art. Nr.
GU10 QPAR51	
■ schwarz	184450
GU10 QPAR51	
■ chrom / schwarz	185450
GU10 QPAR51	
■ grau	184452

Leuchtmittlempfehlung

LED GU10 7,2W 36°
3000K 520lm EEK=A+
8kWh/1000h
Art. Nr. 1001563



LED GU10 5,5W 38°
2700K 400lm EEK=A+
6kWh/1000h
Art. Nr. 1001030



Leuchtmittelangaben

2x max. 50W QPAR51
Ø: 5,1 cm max. L: 5,7 cm max.

Variante	Art. Nr.
GU10 QPAR51	
■ schwarz	184440
GU10 QPAR51	
■ schwarz / chrom	185440

KANO
EASYTEC® II, QPAR51

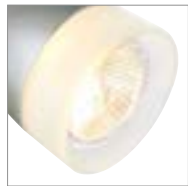
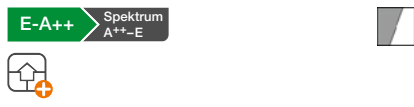

ANILA
EASYTEC® II, QPAR51

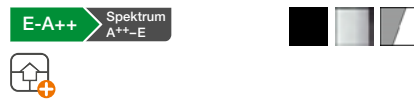

YOKI
EASYTEC® II, QPAR111

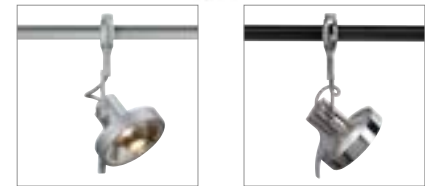
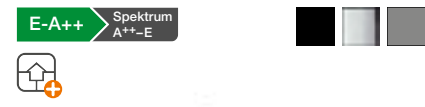

Produktangaben

220-240V ~50/60Hz
Material: Aluminium / Glas

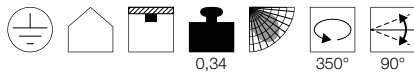

0,34 350° 90°

Produktangaben

230V ~50Hz
Material: Aluminium / Glas

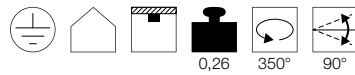

0,26 350° 90°

Produktangaben

220-240V ~50/60Hz
Material: Aluminium

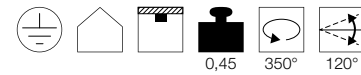

0,45 350° 120°

Maßzeichnung

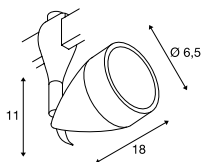

Maßzeichnung

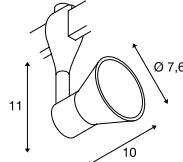

Maßzeichnung

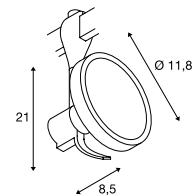

Leuchtmittlempfehlung

LED GU10 5,5W 38°
2700K 400lm EEK=A+
6kWh/1000h
Art. Nr. 1001030



LED GU10 7,2W 36°
3000K 520lm EEK=A+
8kWh/1000h
Art. Nr. 1001562



Leuchtmittlempfehlung

LED GU10 7,2W 36°
4000K 540lm EEK=A+
8kWh/1000h
Art. Nr. 1001565



LED GU10 7,2W 36°
2700K 520lm EEK=A+
8kWh/1000h
Art. Nr. 1001560



Leuchtmittlempfehlung

GU10 7W 40°
3000K 560lm EEK=A+
8kWh/1000h
Art. Nr. 1001573



LED GU10 13W 30°
2700K 1100lm EEK=A+
13kWh/1000h
Art. Nr. 1001242



Leuchtmittelangaben

max. 50W QPAR51
Ø: 5,1 cm max. L: 5,7 cm max.

Leuchtmittelangaben

max. 50W QPAR51
Ø: 5,1 cm max. L: 5,7 cm max.

Leuchtmittelangaben

max. 75W QPAR111

Variante	Art. Nr.
GU10 QPAR51	
■ grau / matt transparent	184071

Variante	Art. Nr.
GU10 QPAR51	
■ schwarz	184630
GU10 QPAR51	
■ chrom	185632
GU10 QPAR51	
■ grau / transparent	184634

Variante	Art. Nr.
GU10 QPAR111	
■ schwarz	184620
GU10 QPAR111	
■ chrom	185622
GU10 QPAR111	
■ grau	184624



185692 413



185692 413

LIGHT EYE® 90
TRACK
EASYTEC® II, QPAR51



E-A++ Spektrum
A++-E

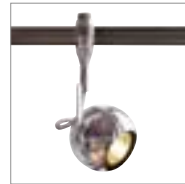
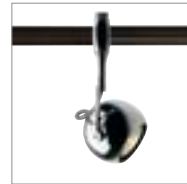

- Der Optionale Dekoring für das Leuchtmittel in der passenden Farbe verringert den Abstand zwischen Gehäuse und Leuchtmittel

Produktangaben

230V ~50Hz
Material: Stahl

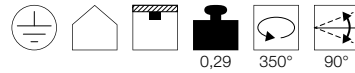

Maßzeichnung

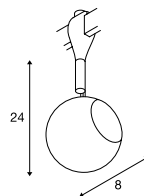

Zubehörempfehlung

Leuchtmittel Dekoring Ø 5,7cm
Art. Nr. 151049



Leuchtmittlempfehlung

LED GU10 5,5W 38°
2700K 400lm EEK=A+
6kWh/1000h
Art. Nr. 1001030



LED GU10 7,2W 36°
2700K 570lm EEK=A+
8kWh/1000h
Art. Nr. 560542



Leuchtmittelangaben

max. 50W QPAR51
Ø: 5,1 cm max. L: 5,7 cm max.

Variante	Art. Nr.
GU10 QPAR51	
■ schwarz	184690
GU10 QPAR51	
■ chrom	185692

LIGHT EYE® 150
TRACK
EASYTEC® II, QPAR111



E-A++ Spektrum
A++-E

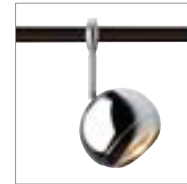

Produktangaben

230V ~50Hz
Material: Stahl

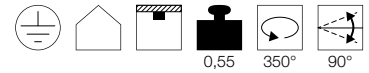

Maßzeichnung

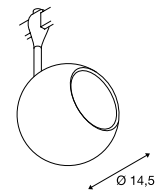

Zubehörempfehlung

Leuchtmittel Dekoring Ø 5,7cm
Art. Nr. 151049



Leuchtmittlempfehlung

LED GU10 10W 38°
3000K 630lm EEK=A+
10kWh/1000h
Art. Nr. 1001029



LED GU10 7W 13°
3000K 660lm EEK=A+
8kWh/1000h
Art. Nr. 1001568



Leuchtmittelangaben

max. 75W QPAR111

Variante	Art. Nr.
GU10 QPAR111	
■ schwarz	184580
GU10 QPAR111	
■ chrom	185582
GU10 QPAR111	
■ schwarz / chrom	185580

LIGHT EYE® 150

TRACK

EASYTEC® II, PD, QPAR111



E-A++ Spektrum A++-E

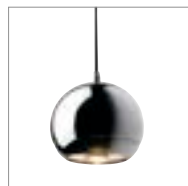
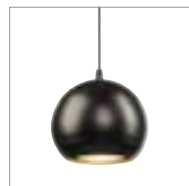
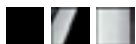

TONGA®

EASYTEC® II, PD, E14



E-A++ Spektrum A+++-E



• Keramikschild

Produktangaben

230V ~50Hz
Material: Stahl

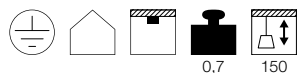

Maßzeichnung

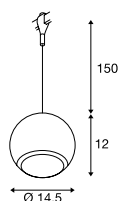

Leuchtmittlempfehlung

GU10 7,9W 40°
4000K 760lm EEK=A+
8kWh/1000h
Art. Nr. 560724



LED GU10 13W 30°
2700K 1100lm EEK=A+
13kWh/1000h
Art. Nr. 1001242



Leuchtmittelangaben

max. 75W QPAR111

Variante	Art. Nr.
GU10 QPAR111	
■ schwarz	184590
GU10 QPAR111	
■ chrom / schwarz	185590
GU10 QPAR111	
■ chrom	185592

Produktangaben

230V ~50Hz
Material: Aluminium / Glas

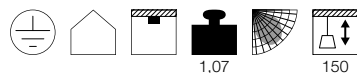

Maßzeichnung

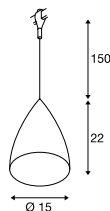

Leuchtmittlempfehlung

E14 3,4W 260°
3000K 250lm EEK=A+
4kWh/1000h
Art. Nr. 560362



LED E14 6,5W 280°
3000K 480lm EEK=A+
7kWh/1000h
Art. Nr. 560372



Leuchtmittelangaben

max. 60W C35
Ø: 5 cm max. L: 13 cm max.

Variante	Art. Nr.
E14 C35	
■ schwarz / weiß	184530
E14 C35	
■ grau / glänzend milchig	184534





185590 414



133444 414

EASYTEC® II
Schiene 2m, inkl. EndkappenEASYTEC® II
Schiene 2m, inkl. EndkappenEASYTEC® II
Schiene 2m, inkl. Endkappen

			
Bemessungsspannung	230V ~50Hz	230V ~50Hz	230V ~50Hz
Strombelastung max.	16A	16A	16A
Einspeisemöglichkeit	nein	nein	nein
Material	Aluminium	Aluminium	Aluminium
Farbe	schwarz	schwarz / chrom	grau
Länge	200 cm	200 cm	200 cm
Breite	1 cm	1 cm	1 cm
Höhe	3 cm	3 cm	3 cm
Gewicht	1 kg	1 kg	1 kg
Art. Nr.	184020	185020	184022

Einspeiser

16A max.
Aluminium / Glas
L: 7,5 cm B: 7,5 cm H: 6 cm
Gewicht: 0,23 kg
1 Stk.



Variante	Art. Nr.
■ schwarz	184004
■ chrom	185002
■ grau	184002

Deckenabhangung, fl xibel

Aluminium
Gewicht: 0,11 kg
1 Stk.



Variante	Art. Nr.
■ schwarz	184060
■ schwarz / chrom	185062
■ grau	184062

Flexverbinder

16A max.
Kunststoff
L: 21,5 cm B: 3 cm H: 4 cm
Gewicht: 0,3 kg
1 Stk.



Variante	Art. Nr.
■ schwarz	184300
■ chrom	185302
■ grau	184302

Shortbox

16A max.
Aluminium / Stahl
B: 22 cm H: 10,5 cm T: 6 cm
Gewicht: 0,57 kg
Mit der Shortbox ist eine einfache
Montage der Schienen möglich. Bei
einer seitlichen Ausladung > 75 cm
wird eine Deckenabhangung 10 cm
benötigt.
1 Stk.



Variante	Art. Nr.
■ schwarz	184010
■ schwarz / chrom	185012
■ grau	184012

Endkappen

Kunststoff
Gewicht: 0,03 kg
2 Stk.



Variante	Art. Nr.
■ schwarz	184140
■ chrom / schwarz	185142
■ grau	184142

Flexibler Deckenhalter

Aluminium
Gewicht: 0,1 kg
1 Stk.



Variante	Art. Nr.
■ grau	184332
■ schwarz	184330

Längsverbinder

16A max.
Aluminium
Gewicht: 0,08 kg
1 Stk.



Variante	Art. Nr.
■ schwarz	184030
■ chrom	185032
■ grau	184032

Isolierverbinder

Aluminium
Gewicht: 0,08 kg
1 Stk.



Variante	Art. Nr.
■ schwarz	184170
■ chrom	185172
■ grau	184172

Biegemaschiene

Stahl / Kunststoff
Gewicht: 2,76 kg
1 Stk.



Variante	Art. Nr.
■ grau	184000

Deckenabhangung

Aluminium
L: 10 cm
Gewicht: 0,1 kg
1 Stk.



Variante	Art. Nr.
■ schwarz	184040
■ chrom	185042
■ grau	184042

Pendelleuchtenadapter

3A max.
Aluminium / Kunststoff
L: 13 cm
Gewicht: 0,1 kg
1 Stk.



Variante	Art. Nr.
■ schwarz	184290
■ chrom	185294
■ grau	184292

DETAILVERLIEBT.

NIEDERVOLT-SEILSYSTEM UND VITRINENSCHIENEN SETZEN AKZENTE.

Licht hilft dabei, Räumen Atmosphäre zu geben. Überall dort, wo es gemütlich und gleichzeitig professionell sein soll, sind Niedervolt-Seilsysteme die passende Lösung – denn sie bieten Raum für individuelle Beleuchtungskonzepte und schaffen Gemütlichkeit. Für eine akzentuierte Warenausleuchtung in Vitrinen sind unsere Niedervolt-Vitrinenschienen eine ideale Lösung.

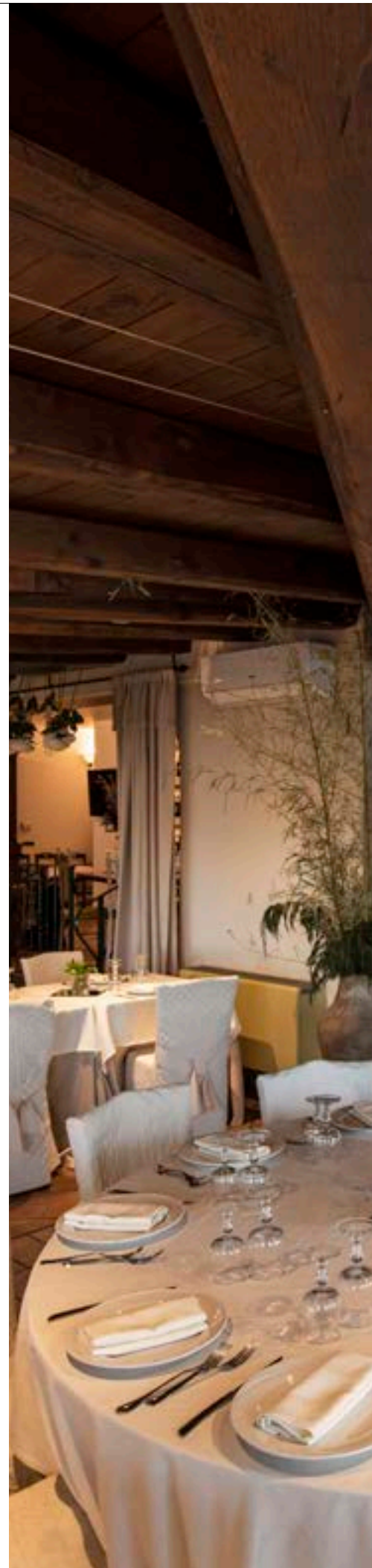



139112 423



139131 422





NIEDERVOLT-SEILSYSTEM UND VITRINENSCHIENE

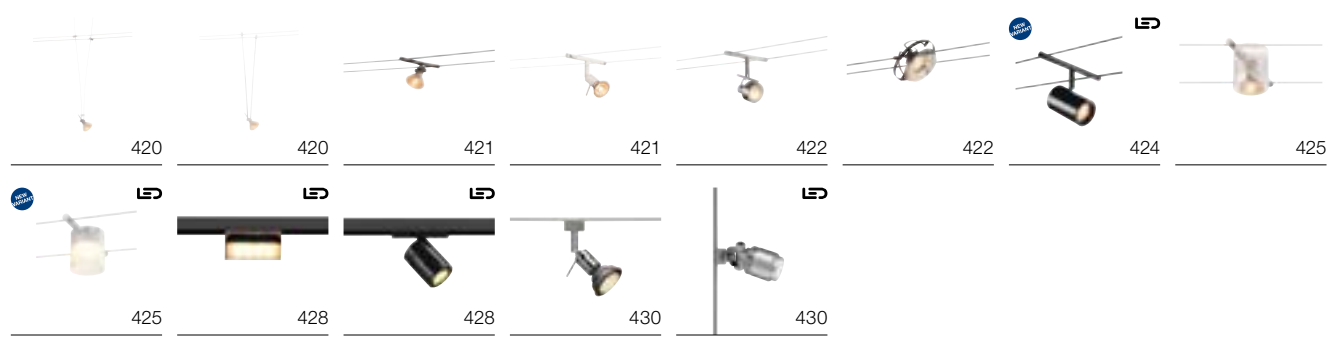

Passendes Zubehör finden Sie auf den Seiten 426, 427, 429 und 431

 Weitere Leuchten und Varianten finden Sie online unter www.slv.com

ASMARA
LV, QR-C51

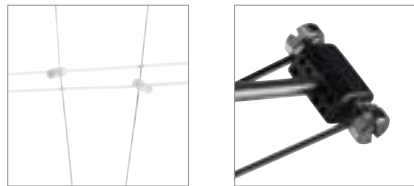

TELESKOP
LV, QR-C51

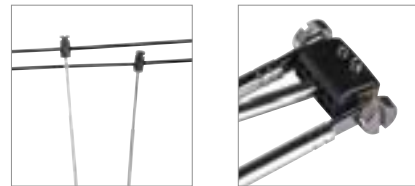

Produktangaben

12V ~50Hz
Material: Edelstahl

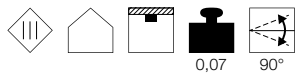

Maßzeichnung

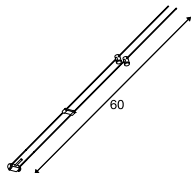

Produktangaben

12V ~50Hz
Material: Messing / Stahl

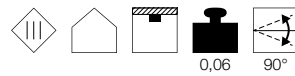

Maßzeichnung

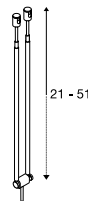

Hinweis

Teleskop von 21-51 cm einstellbar

Leuchtmittlempfehlung

LED GU5.3 5,5W 36°
2700K 450lm EEK=A+
7kWh/1000h
Art. Nr. 1001574



LED GU5.3 5,5W 36°
3000K 460lm EEK=A+
7kWh/1000h
Art. Nr. 1001575



Leuchtmittlempfehlung

LED GU5.3 5,5W 36°
2700K 450lm EEK=A+
7kWh/1000h
Art. Nr. 1001574



LED GU5.3 5,5W 36°
3000K 460lm EEK=A+
7kWh/1000h
Art. Nr. 1001575



Leuchtmittelangaben

max. 35W QR-C51

Variante	Art. Nr.
GX5.3 QR-C51	
■ schwarz	139070
GX5.3 QR-C51	
□ weiß	139071
GX5.3 QR-C51	
■ chrom	139072

Leuchtmittelangaben

max. 20W QR-C51

Variante	Art. Nr.
GX5.3 QR-C51	
■ schwarz	139080
GX5.3 QR-C51	
□ weiß	139081
GX5.3 QR-C51	
■ chrom	139082



139071 420



139081 420



139090 421



139102 421

COSMIC
LV, QR-C51



SYROS
LV, QR-C51



Produktangaben

12V ~50Hz
Material: Stahl / Messing

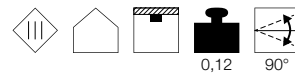

0,12 90°

Produktangaben

12V ~50Hz
Material: Stahl / Messing

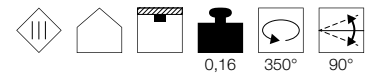

0,16 350° 90°

Maßzeichnung

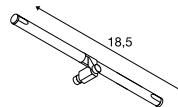

Maßzeichnung

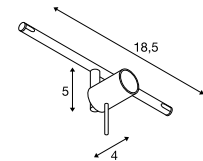

Leuchtmittlempfehlung

LED GU5.3 5,5W 36°
2700K 450lm EEK=A+
7kWh/1000h
Art. Nr. 1001574



LED GU5.3 5,5W 36°
3000K 460lm EEK=A+
7kWh/1000h
Art. Nr. 1001575



Leuchtmittlempfehlung

LED GU5.3 5,5W 36°
2700K 450lm EEK=A+
7kWh/1000h
Art. Nr. 1001574



LED GU5.3 5,5W 36°
3000K 460lm EEK=A+
7kWh/1000h
Art. Nr. 1001575



Leuchtmittelangaben

max. 35W QR-C51

Variante	Art. Nr.
GX5.3 QR-C51	
■ schwarz	139090
GX5.3 QR-C51	
□ weiß	139091
GX5.3 QR-C51	
■ chrom	139092

Leuchtmittelangaben

max. 50W QR-C51

Variante	Art. Nr.
GX5.3 QR-C51	
■ schwarz	139100
GX5.3 QR-C51	
□ weiß	139101
GX5.3 QR-C51	
■ chrom	139102

SALUNA
LV, QR-C51

C-A+ Spektrum
A++-E

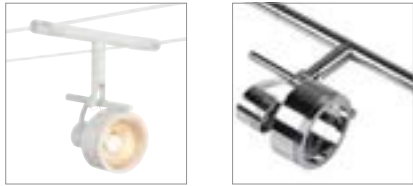

Produktangaben

12V ~50Hz
Material: Stahl / Messing

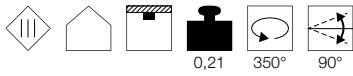

0,21 350° 90°

Maßzeichnung

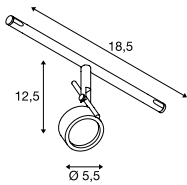

Leuchtmittlempfehlung

LED GU5.3 5,5W 36°
2700K 450lm EEK=A+
7kWh/1000h
Art. Nr. 1001574



LED GU5.3 5,5W 36°
3000K 460lm EEK=A+
7kWh/1000h
Art. Nr. 1001575



Leuchtmittelangaben

max. 35W QR-C51

Variante	Art. Nr.
GX5.3 QR-C51	
■ schwarz	139130
GX5.3 QR-C51	
□ weiß	139131
GX5.3 QR-C51	
■ chrom	139132



139131 422

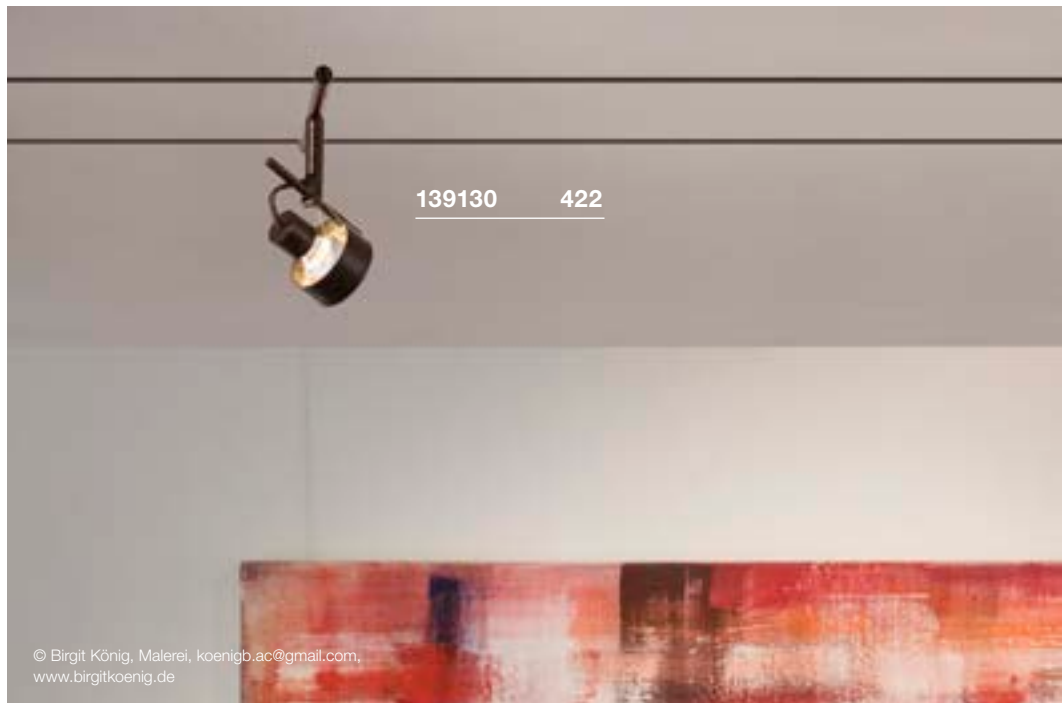

139130 422

© Birgit König, Malerei, koenigb.ac@gmail.com,
www.birgitkoenig.de

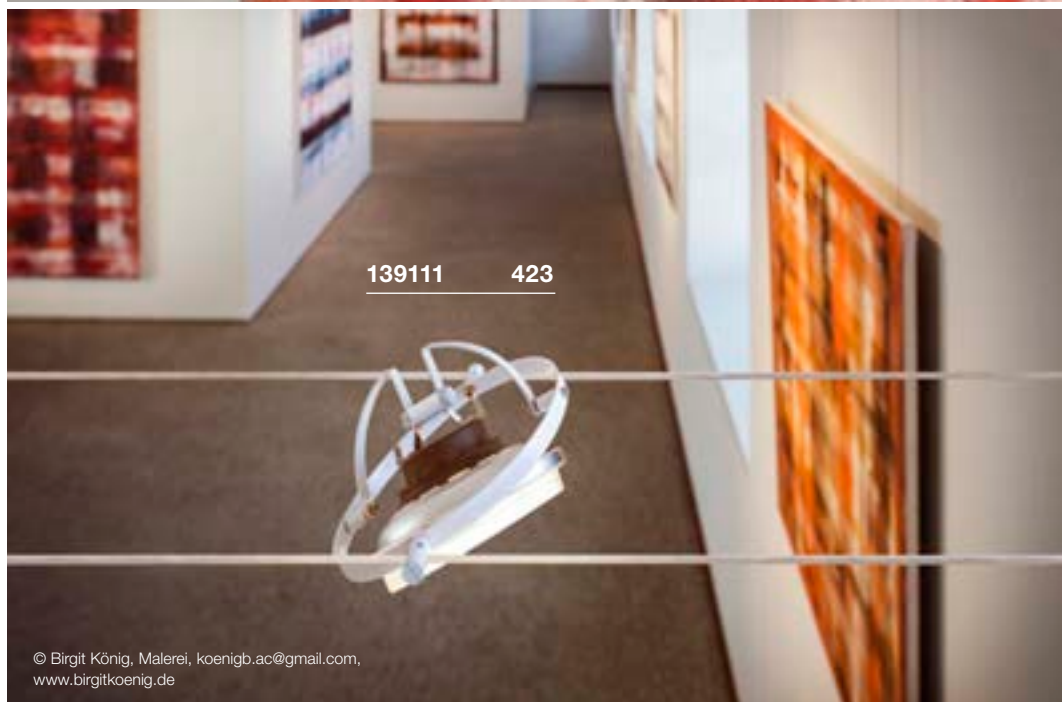

139111 423

© Birgit König, Malerei, koenigb.ac@gmail.com,
www.birgitkoenig.de

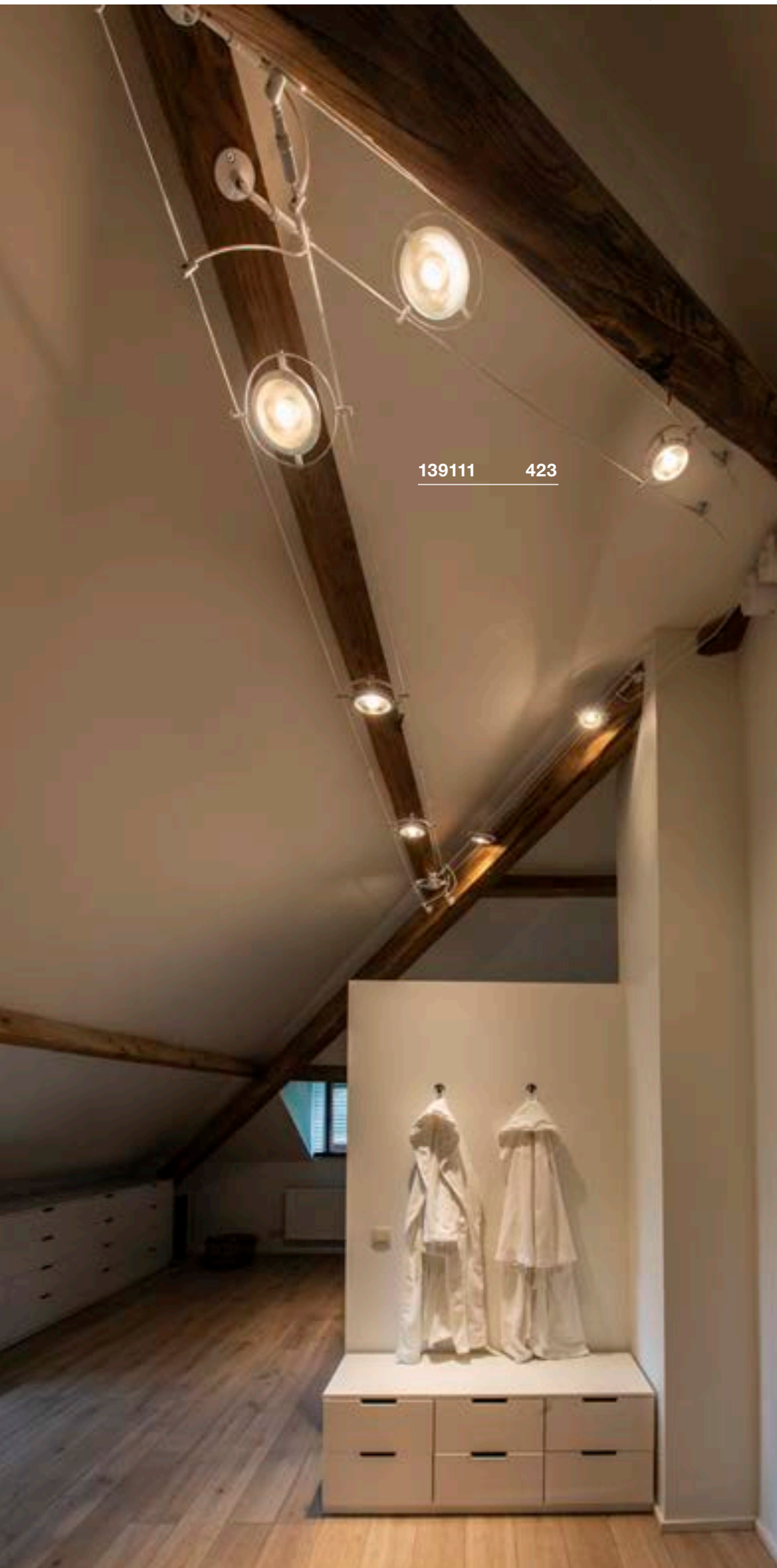

139111 423

QRB LV, QR111

C-A+ Spektrum
A++-E

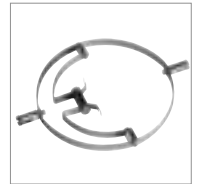
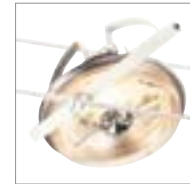

Produktangaben

12V ~50Hz
Material: Stahl

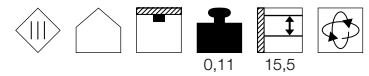

0,11 15,5

Maßzeichnung

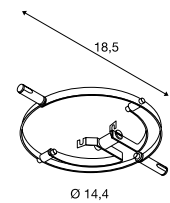

Leuchtmittlempfehlung

LED G53 15W 40°
2700K 750lm EEK=A
17kWh/1000h
Art. Nr. 560232



LED G53 15W 40°
3000K 760lm EEK=A
17kWh/1000h
Art. Nr. 560234



Leuchtmittelangaben

max. 50W QR111

Variante	Art. Nr.
G53 QR111	
■ schwarz	139110
G53 QR111	
□ weiß	139111
G53 QR111	
■ chrom	139112

NOBLO SPOT
LV, Rope Track



A-A++ Spektrum
A++-E



LED
INSIDE

NEW
VARIANT



1002695 424

Produktangaben

12V ~50Hz
Material: Aluminium / Polymethylacrylat (PMMA)

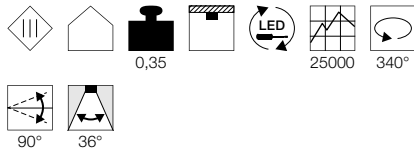

Maßzeichnung

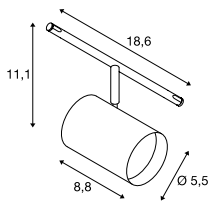

Variante	Art. Nr.
420lm 2700K CRI>80 ■ schwarz	1002694
450lm 2700K CRI>80 □ weiß	1002695
450lm 2700K CRI>80 ■ chrom	1002696





1002690 425



139120 425

COMET
LV, QR-C51

C-A+ Spektrum A++-E



Produktangaben

12V ~50Hz
Material: Messing / Messing

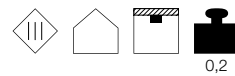

0,2

Maßzeichnung

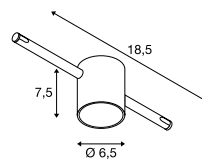

Leuchtmittelpfhlung

LED GU5.3 5,5W 36°
2700K 450lm EEK=A+
7kWh/1000h
Art. Nr. 1001574



LED GU5.3 5,5W 36°
3000K 460lm EEK=A+
7kWh/1000h
Art. Nr. 1001575



Leuchtmittelangaben

max. 50W QR-C51

Variante	Art. Nr.
GU5.3 QR-C51	
■ schwarz / transparent	139120
GU5.3 QR-C51	
□ weiß / matt transparent	139121
GU5.3 QR-C51	
■ chrom	139122

COMET LED
LV

A-A++ Spektrum A++-E



LED INSIDE

NEW VARIANT

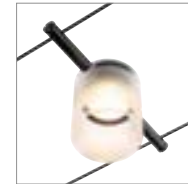

• Satinierter Glaskörper

Produktangaben

12V ~50Hz
Systemleistung: 6,3W
Material: Aluminium / Glas



0,257

25000

Maßzeichnung

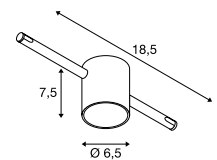

Variante	Art. Nr.
410lm 2700K CRI>80	
■ schwarz / gefrosted	1002688
410lm 2700K CRI>80	
□ weiß / gefrosted	1002689
410lm 2700K CRI>80	
■ chrom / gefrosted	1002690

AUFBAU

Seilkonstruktion für die Montage zwischen senkrecht verlaufenden Wänden

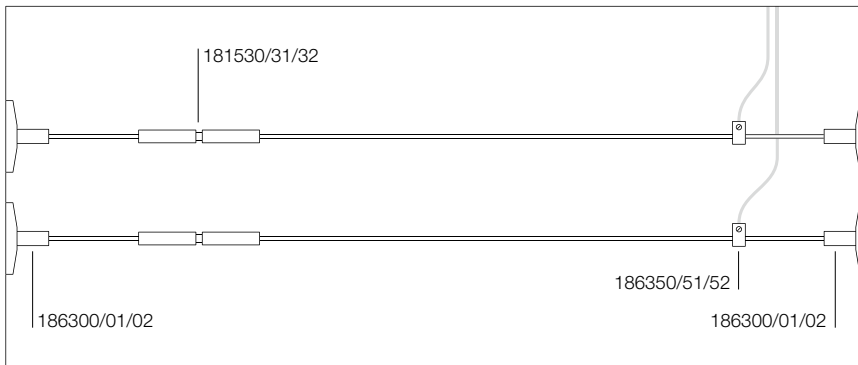

Für diesen Aufbau benötigte Artikel

Wandhalter	186300/01/02	x 2 St.
Einspeiser	186350/51/52	x 1 St.
Seilspanner	181530/31/32	x 1 St.

Seilkonstruktion ohne Seilzug für die Montage zwischen senkrecht verlaufenden Wänden

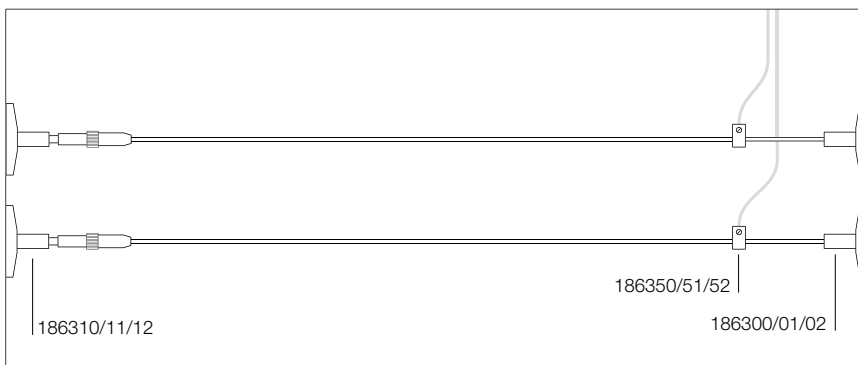

Für diesen Aufbau benötigte Artikel

Wandhalter	186300/01/02	x 1 St.
Wand-/Deckenhalter, flexibel	186310/11/12	x 1 St.
Einspeiser	186350/51/52	x 1 St.

Seilkonstruktion für die Montage von Wand zu Wand mit Richtungswechsel

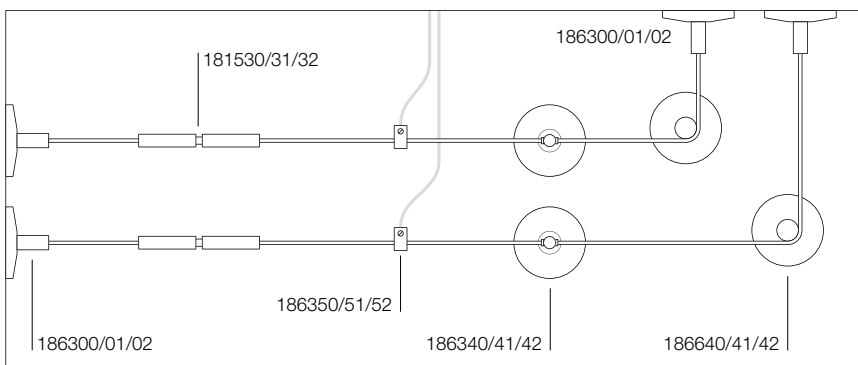

Für diesen Aufbau benötigte Artikel

Wandhalter	186300/01/02	x 2 St.
Umlenker*	186640/41/42	x 1 St.
Deckenhalter	186340/41/42	x 1 St.
Seilspanner	181530/31/32	x 1 St.
Einspeiser	186350/51/52	x 1 St.

*Achtung: Umlenker eignen sich nicht als Halterung. Bitte wählen Sie einen geeigneten Deckenhalter, um das System an der Decke zu befestigen.

Seilkonstruktion für die Montage zwischen NICHT senkrecht verlaufenden Wänden

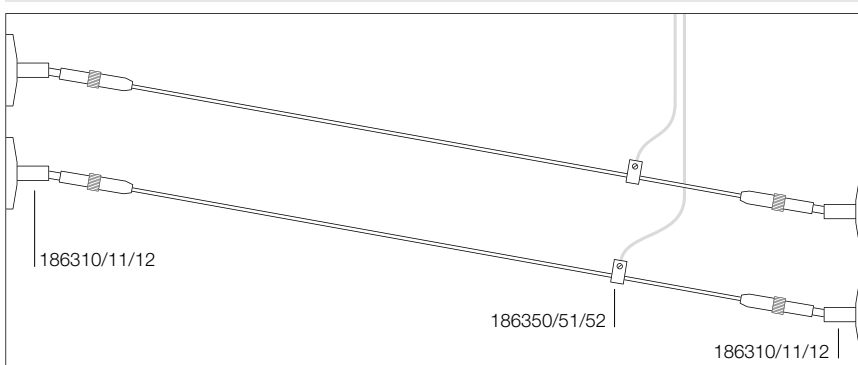

Für diesen Aufbau benötigte Artikel

Wand-/Deckenhalter, flexibel	186310/11/12	x 2 St.
Einspeiser	186350/51/52	x 1 St.

AUFBAU

Getrennt schaltbare Seilkonstruktion für die Montage von Wand zu Wand

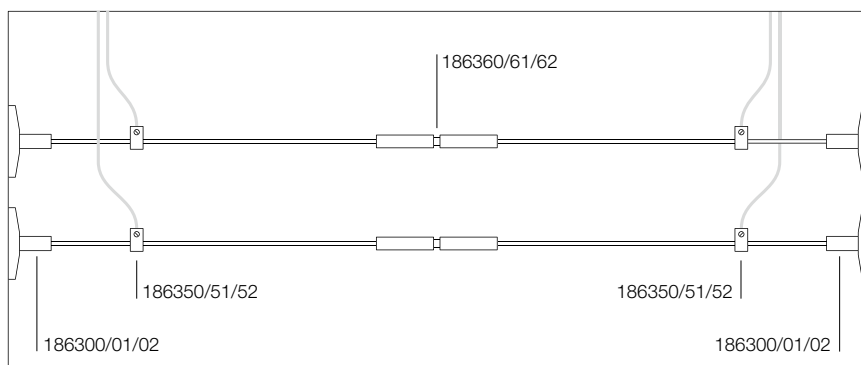

Für diesen Aufbau benötigte Artikel

Wandhalter	186300/01/02	x 2 St.
Isolierverbinder	186360/61/62	x 1 St.
Seilspanner	181530/31/32	x 1 St.
Einspeiser	186350/51/52	x 2 St.

Seilkonstruktion für die Montage von Wand zu Decke

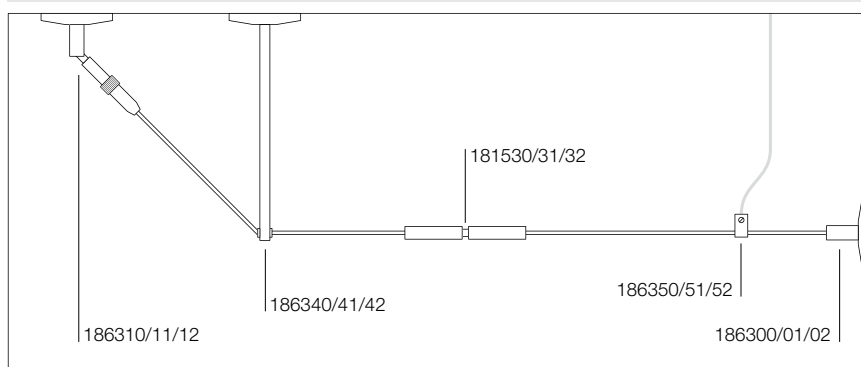

Für diesen Aufbau benötigte Artikel

Wandhalter	186300/01/02	x 1 St.
Wand-/Deckenhalter, flexibel	186310/11/12	x 1 St.
Seilspanner	181530/31/32	x 1 St.
Deckenhalter 16 cm	186340/41/42	x 1 St.
Einspeiser	186350/51/52	x 1 St.

Seilkonstruktion für die Montage von Decke zu Decke

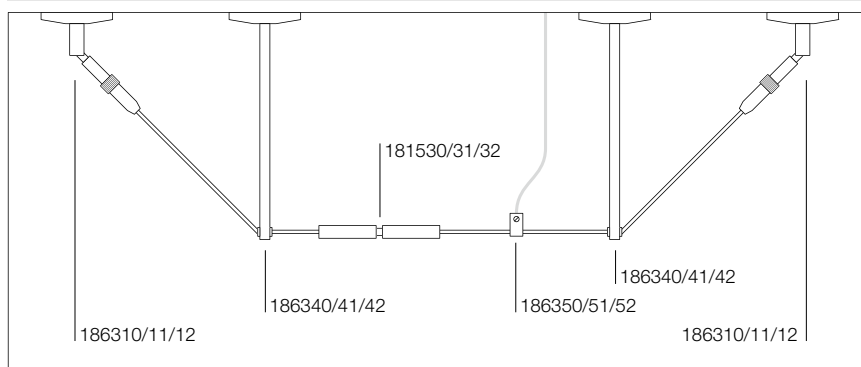

Für diesen Aufbau benötigte Artikel

Wand-/Deckenhalter, flexibel	186310/11/12	x 2 St.
Seilspanner	181530/31/32	x 1 St.
Deckenhalter 16 cm	186340/41/42	x 2 St.
Einspeiser	186350/51/52	x 1 St.

HINWEIS

Alle Zubehörteile beinhalten jeweils 2 Stück pro Artikelnummer.
Der Preis bezieht sich auf den Zweierpack.

Das Niedervolt-Seil ist mit einer Isolierhülle ausgerüstet.

Bitte verwenden Sie ausschließlich die bei uns erhältlichen 12V Transformatoren.







Niedervolt-Seil
4 mm², 10 m



TENSEO
4 mm², 10m

TENSEO
4 mm², 10 m

TENSEO
4 mm², 10 m

						
Spannung max.	48V		48V		48V	
Strombelastung max.	25A		25A		25A	
Material	Kupfer / Kunststoff		Kupfer / Kunststoff		Kupfer / Kunststoff	
Farbe	schwarz		weiß		transparent	
Durchmesser	0,4 cm		0,4 cm		0,4 cm	
Länge	1000 cm		1000 cm		1000 cm	
Gewicht	0,48 kg		0,48 kg		0,48 kg	
Art. Nr.	1002602		1002603		1002604	







Niedervolt-Seil
4 mm², 20 m



TENSEO
4 mm², 20 m

TENSEO
4 mm², 20 m

TENSEO
4 mm², 20 m

						
Spannung max.	48V		48V		48V	
Strombelastung max.	25A		25A		25A	
Material	Kupfer / Kunststoff		Kupfer / Kunststoff		Kupfer / Kunststoff	
Farbe	schwarz		weiß		transparent	
Durchmesser	0,4 cm		0,4 cm		0,4 cm	
Länge	2000 cm		2000 cm		2000 cm	
Gewicht	0,88 kg		0,88 kg		0,85 kg	
Art. Nr.	139030		139031		139024	







Niedervolt-Seil
4 mm², 100 m



TENSEO
4 mm², 100 m

TENSEO
4 mm², 100 m

TENSEO
4 mm², 100 m

						
Spannung max.	48V		48V		48V	
Strombelastung max.	25A		25A		25A	
Material	Kupfer / Kunststoff		Kupfer / Kunststoff		Kupfer / Kunststoff	
Farbe	schwarz		weiß		transparent	
Durchmesser	0,4 cm		0,4 cm		0,4 cm	
Länge	10000 cm		10000 cm		10000 cm	
Gewicht	4,4 kg		4,4 kg		4,26 kg	
Art. Nr.	139040		139041		139004	







Niedervolt-Seil
6 mm², 20 m



TENSEO
6 mm², 20 m

TENSEO
6 mm², 20 m

TENSEO
6 mm², 20 m

						
Spannung max.	48V		48V		48V	
Strombelastung max.	25A		25A		25A	
Material	Kupfer / Kunststoff		Kupfer / Kunststoff		Kupfer / Kunststoff	
Farbe	schwarz		weiß		transparent	
Durchmesser	0,4 cm		0,4 cm		0,4 cm	
Länge	2000 cm		2000 cm		2000 cm	
Gewicht	1,23 kg		1,23 kg		1,21 kg	
Art. Nr.	139050		139051		139026	

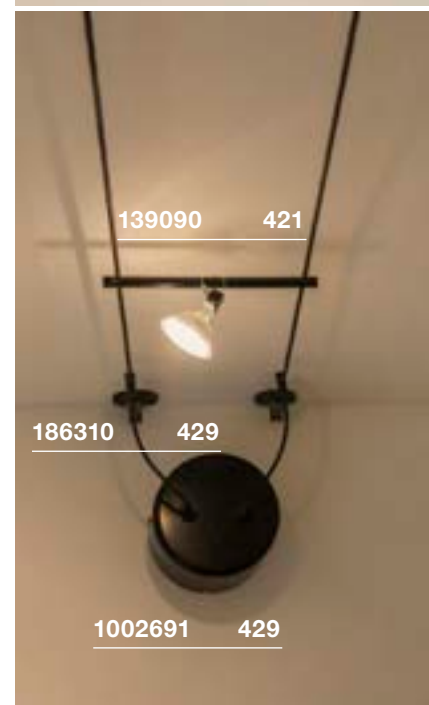
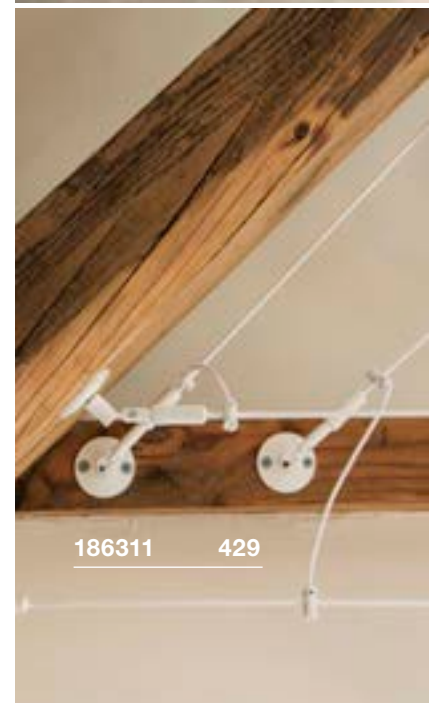
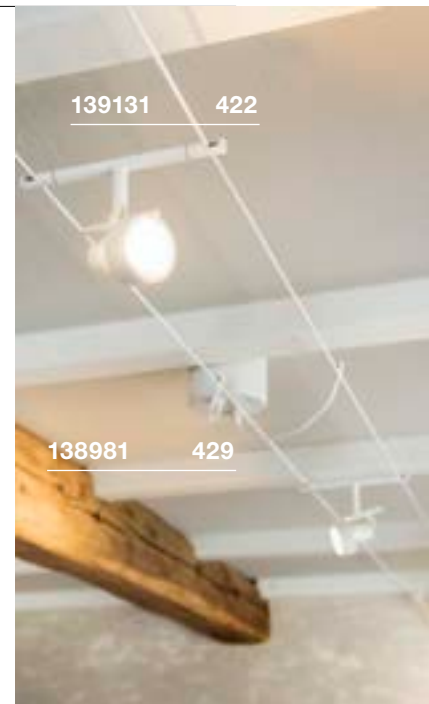

Niedervolt-Seil
6 mm², 100 m

	TENSEO 6 mm ² , 100 m	TENSEO 6 mm ² , 100 m	TENSEO 6 mm ² , 100 m
Spannung max.	48V	48V	48V
Strombelastung max.	25A	25A	25A
Material	Kupfer / Kunststoff	Kupfer / Kunststoff	Kupfer / Kunststoff
Farbe	schwarz	weiß	transparent
Durchmesser	0,4 cm	0,4 cm	0,4 cm
Länge	10000 cm	10000 cm	10000 cm
Gewicht	6,1 kg	6,1 kg	6 kg
Art. Nr.	139060	139061	139006

ZUBEHÖR NIEDERVOLT-SEILSYSTEM TENSEO

TRANSFORMATOR 12V AC | 50VA konventionell

Stahl / Messing
Ø: 11,1 cm H: 11 cm
Gewicht: 1,88 kg
1 Stk.



Variante	Art. Nr.
■ schwarz	1002691
□ weiß	1002692
■ chrom	1002693

Wandhalter 10cm

Stahl / Messing
Ø: 5 cm H: 11,5 cm
Gewicht: 0,08 kg
2 Stk.



Variante	Art. Nr.
■ schwarz	186310
□ weiß	186311
■ chrom	186312

Deckenumlenker

Stahl / Messing
Ø: 5 cm H: 16 cm
Gewicht: 0,39 kg
2 Stk.



Variante	Art. Nr.
■ schwarz	186640
□ weiß	186641
■ chrom	186642

Transformator 12V | 105VA konventionell

Stahl / Messing
Ø: 11 cm H: 11 cm
Gewicht: 1,6 kg
1 Stk.



Variante	Art. Nr.
■ schwarz	138980
□ weiß	138981
■ chrom	138982

Umlenker 6cm

Stahl / Messing
Ø: 5 cm H: 6 cm
Gewicht: 0,05 kg
2 Stk.



Variante	Art. Nr.
■ schwarz	186330
□ weiß	186331
■ chrom	186332

Abhängeset 2m

Stahl / Aluminium
Ø: 1,25 cm B: 18,6 cm
Gewicht: 0,162 kg
1 Stk.



Variante	Art. Nr.
■ schwarz	1002697
□ weiß	1002698
■ chrom	1002699

Transformator 12V | 210VA konventionell

Stahl / Messing
Ø: 13,5 cm H: 11 cm
Gewicht: 3,05 kg
1 Stk.



Variante	Art. Nr.
■ schwarz	138990
□ weiß	138991
■ chrom	138992

Umlenker

Stahl / Messing
Ø: 5 cm H: 16 cm
Gewicht: 0,12 kg
2 Stk.



Variante	Art. Nr.
■ schwarz	186340
□ weiß	186341
■ chrom	186342

Abstandshalter

Aluminium
Ø: 1,25 cm B: 9 cm
Gewicht: 0,35 kg
2 Stk.



Variante	Art. Nr.
■ schwarz	1002700
□ weiß	1002701
■ chrom	1002702

Seilspanner

25A max.
Messing
Ø: 1 cm H: 11 cm
Gewicht: 0,04 kg
2 Stk.



Variante	Art. Nr.
■ schwarz	181530
□ weiß	181531
■ chrom	181532

Einspeiser

25A max.
Messing
Ø: 1 cm H: 1,8 cm
Gewicht: 0,04 kg
2 Stk.



Variante	Art. Nr.
■ schwarz	186350
□ weiß	186351
■ chrom	186352

Abstandshalter mit Verbinder

25A max.
Messing
Ø: 1,25 cm B: 9 cm
Gewicht: 0,82 kg
2 Stk.



Variante	Art. Nr.
■ schwarz	1002703
□ weiß	1002704
■ chrom	1002705

Wandhalter

Stahl / Messing
Ø: 5 cm L: 3 cm
Gewicht: 0,05 kg
2 Stk.



Variante	Art. Nr.
■ schwarz	186300
□ weiß	186301
■ chrom	186302

Isolierverbinder

25A max.
Aluminium / Kunststoff
Ø: 1 cm L: 6,4 cm
Gewicht: 0,04 kg
2 Stk.



Variante	Art. Nr.
■ schwarz	186360
□ weiß	186361
■ chrom	186362

M-TRACK
Adjustable Light

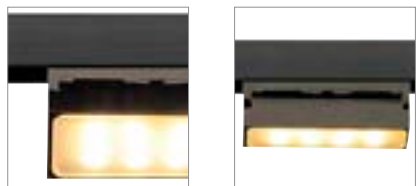

- Spots einfach versetzbar durch Magenthalerung

Produktangaben

12V DC
Material: Aluminium / Polycarbonat (PC)

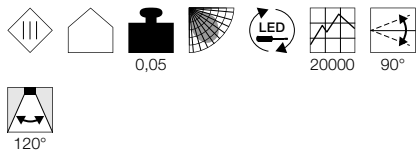

Maßzeichnung

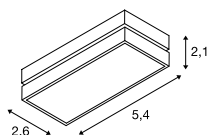

M-TRACK
Spot



- Spots einfach versetzbar durch Magnethalterung

Produktangaben

12V DC
Material: Aluminium / Polycarbonat (PC)

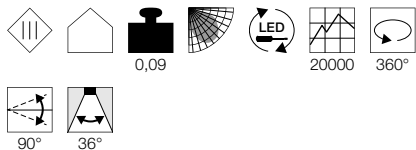

Maßzeichnung

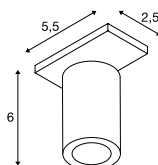

Variante	Art. Nr.
260lm 3000K CRI>80 ■ schwarz	188550

Variante	Art. Nr.
400lm 3000K CRI>80 ■ schwarz	188530



188550 430

M-TRACK
Stromschiene

Bemessungsspannung	12V DC
Spannung max.	12V DC
Strombelastung max.	9A
Material	Aluminium
Farbe	schwarz
Länge	200 cm
Breite	3 cm
Höhe	1,4 cm
Gewicht	1,05 kg

Art. Nr.	188500
-----------------	---------------

Einspeiser

ABS / Polycarbonat (PC)
L: 3,6 cm B: 3 cm H: 1,6 cm
Gewicht: 0,01 kg
1 Stk.



Variante	Art. Nr.
■ schwarz	188510

Endkappe

ABS / Polycarbonat (PC)
L: 3 cm B: 1,4 cm H: 0,5 cm
Gewicht: 0,01 kg
1 Stk.



Variante	Art. Nr.
■ schwarz	188520

Zubehörempfehlung

LED Netzteil 12V DC | 12W

Art. Nr.	470507
-----------------	---------------

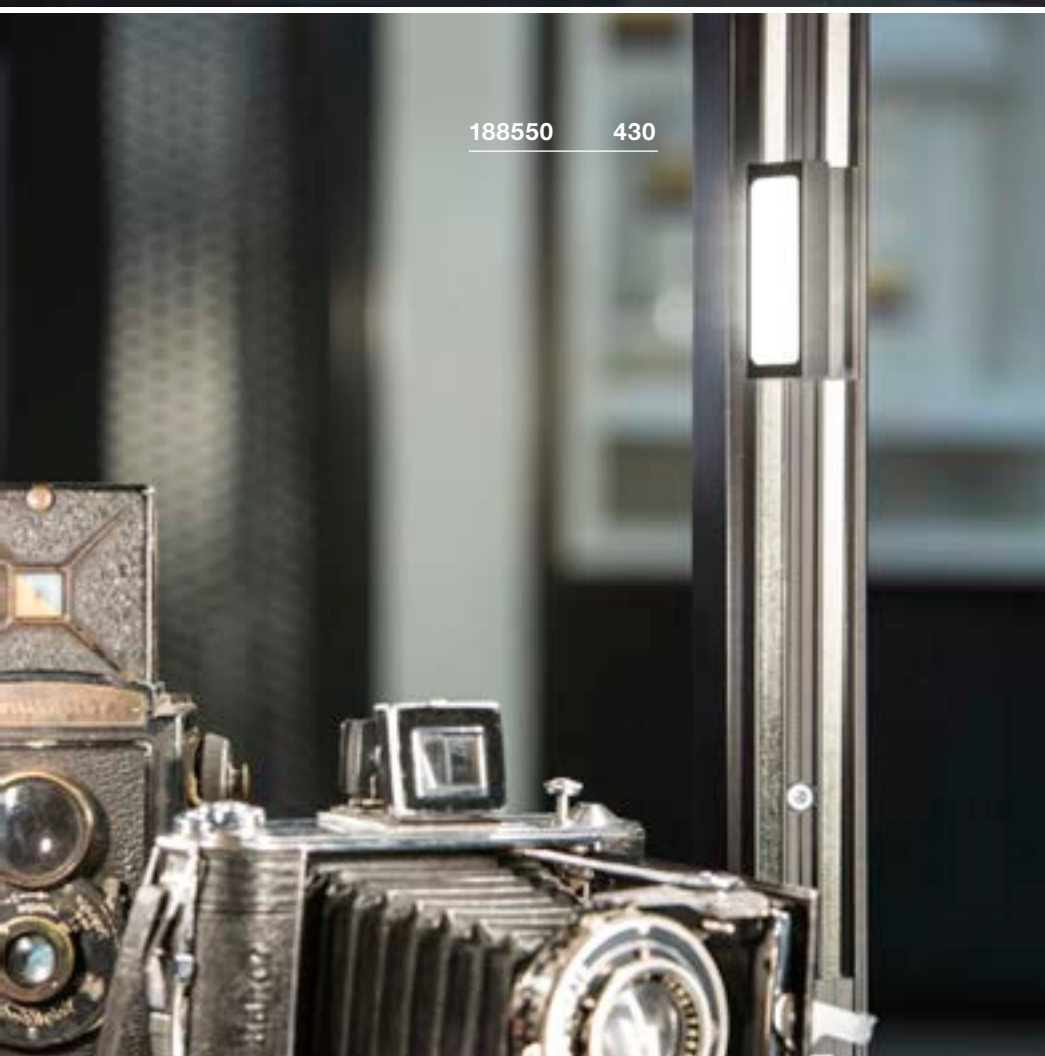

188550 430



SOLO 90°
GLU-TRAX®, QR-C51

C-A+ Spektrum
A++-E

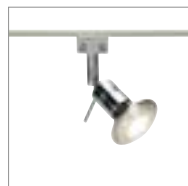
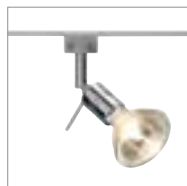

POWER-LED SPOT
GLU-TRAX®

A-A++ Spektrum
A++-E



Produktangaben

12V ~50Hz
Material: Messing

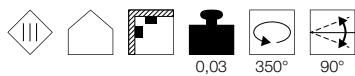

0,03 350° 90°

Produktangaben

12V ~50/60Hz
Material: Aluminium / Polycarbonat (PC)



0,04 30000 360°

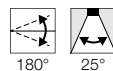

180° 25°

Maßzeichnung

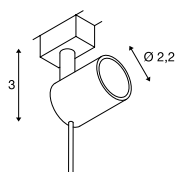

Maßzeichnung

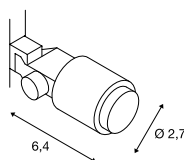

Hinweis

Betrieb nur mit konventionellem Trafo!

Leuchtmittlempfehlung

GU5.3 5W 36°
2700K 345lm EEK=A+
6kWh/1000h
Art. Nr. 551862



LED GU5.3 5,5W 36°
2700K 450lm EEK=A+
7kWh/1000h
Art. Nr. 1001574



Leuchtmittelangaben

max. 35W QR-C51

Variante	Art. Nr.
GU5.3 QR-C51	
■ chrom	186272

Variante	Art. Nr.
55lm 3000K CRI>80	
■ grau	186042



186042

432



186042 432



GLU-TRAX®
Schiene, 1,5m

Bemessungsspannung	12V AC
Strombelastung max.	20 A
Einspeisemöglichkeit	nein
Material	Polycarbonat (PC)
Farbe	transparent
Länge	150 cm
Breite	1 cm
Höhe	0,5 cm
Gewicht	0,2 kg
Art. Nr.	186015

Hinweis Einfache Montage mit Clips oder Verkleben

ROBOT QR-C51 Leuchtmittelhalter	
Stahl / Kunststoff	
L: 3 cm B: 2,2 cm H: 3 cm	
Gewicht: 0,02 kg	
1 Stk.	
Variante	Art. Nr.
■ chrom	186762

Doppelseitiges Klebeband	
L: 300 cm B: 0,9 cm	
1 Stk.	
Variante	Art. Nr.
	220000

Flexibler Längsverbinder	
20A max.	
Stahl	
L: 7,3 cm B: 1,4 cm H: 0,8 cm	
Gewicht: 0,02 kg	
1 Stk.	
Variante	Art. Nr.
■ grau	186772

Montageclips, 10 Stk.	
Kunststoff P	
Ø: 1,7 cm H: 0,8 cm	
10 Stk.	
Variante	Art. Nr.
	186020

Einspeiser/Längsverbinder	
20A max.	
Stahl / Kunststoff	
L: 1,5 cm B: 1,4 cm H: 0,8 cm	
Gewicht: 0,01 kg	
1 Stk.	
Variante	Art. Nr.
■ grau	186952

TIEF VERWURZELT.

EINBAULEUCHTEN BEEINDRUCKEN MIT STRAHLKRAFT.

Ob gerichtet oder breitstrahlend, statisch oder schwenkbar: Einbauleuchten sind das Kernelement vieler Beleuchtungskonzepte und eine gute Alternative zu freihängenden Leuchten. Denn: Sie passen sich jedem Ambiente an und gewähren dabei viel Einrichtungsraum.

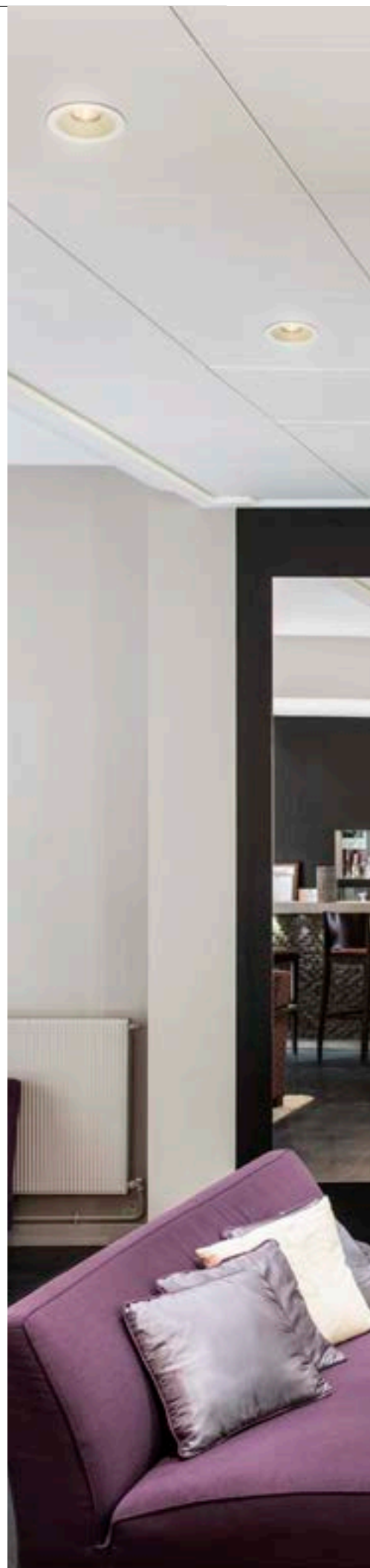



1001841 + 1001851 477

112242 450



UNSER QUALITÄTSVERSPRECHEN

INNOVATION UND ENTWICKLUNG

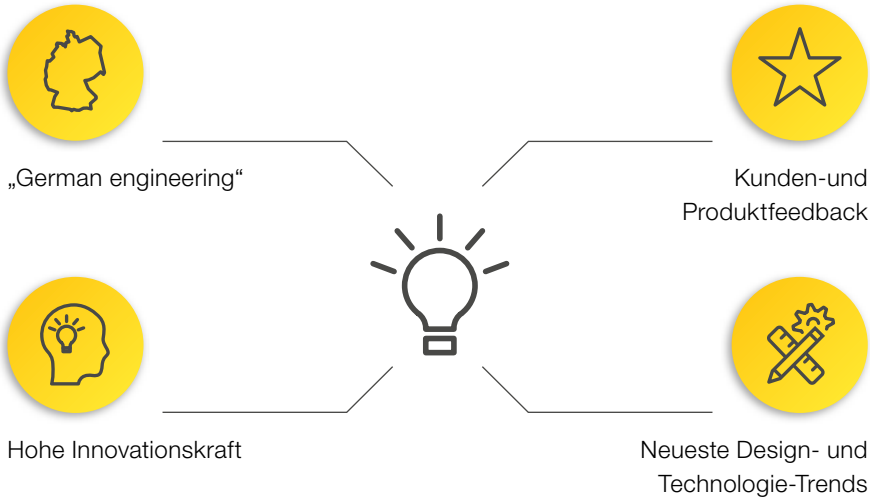

HERSTELLUNG

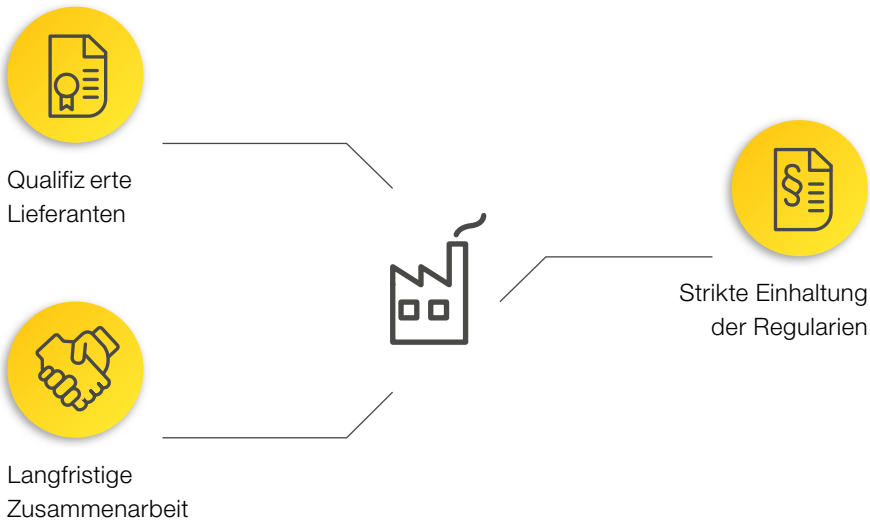



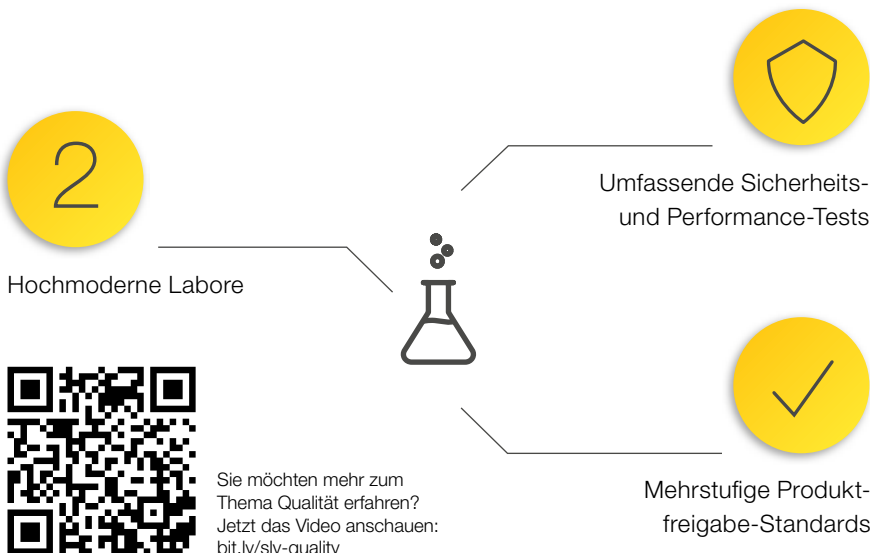













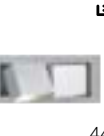













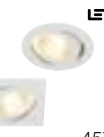



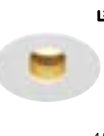





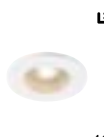

























QUALITÄTSSICHERUNG





EINBAULEUCHTEN





































































 440	 441	 441	 441	 443	 443	 443	 444
 444	 444	 445	 445	 446	 446	 447	 447
 448	 449	 450	 450	 451	 451	 452	 453
 453	 454	 455	 455	 455	 457	 457	 457
 458	 458	 459	 460	 460	 461	 461	 462
 462	 463	 464	 465	 465	 466	 466	 467
 467	 469	 469	 469	 471	 471	 471	 472
 473	 473	 474	 474	 474	 476	 476	 476
 477	 477	 477	 479	 479	 479	 482	 482
 483	 483	 484	 484	 485	 485	 486	 487
 487	 487	 488	 488	 489	 489	 490	 490



1001907 520

1001973 514



 491	 491	 492	 492	 493	 494	 495	 495
 495	 496	 496	 496	 497	 497	 498	 498
 498	 499	 499	 500	 500	 501	 502	 503
 503	 503	 504	 505	 506	 507	 508	 508
 508	 509	 510	 510	 510	 511	 511	 511
 512	 513	 513	 513	 514	 515	 515	 517
 517	 518	 519	 519	 519	 520	 520	 520
 521	 522	 523	 523	 524	 524	 524	 525
 525	 525	 527	 527	 527			



1002979 440



151952 441

NOTAPO WL

A-A++ Spektrum
A++-E

LED
INSIDE

NEW



Produktangaben

700mA | 2,2W
Material: Aluminium
Produktmaße: B: 3,6 cm H: 10,5 cm T: 3,8 cm



35000

Hinweis

Beim Anschluss mehrerer Leuchten
ist auf Reihenschaltung zu achten!
Offenes Kabelend

Zubehörempfehlung

LED Treiber 700mA |
3W inkl. Zugentlastung

Art. Nr. 464200

Einbaurahmen

Art. Nr. 1002981



Variante	Art. Nr.
6lm 3000K CRI>90 B: 3,6 cm H:10,5 cm T: 3,8 cm 0,07 kg <input type="checkbox"/> matt weiß	1002979
6lm 3000K CRI>90 B: 3,6 cm H:18 cm T: 3,8 cm 0,1 kg <input type="checkbox"/> matt weiß	1002980



DOWNUNDER PUR 80 EL



DOWNUNDER PUR 120 EL



DOWNUNDER PUR 150 EL



Produktangaben

350mA | 3,6W
Material: Aluminium / Stahl



Produktangaben

350mA | 3,6W
Material: Aluminium / Stahl



Produktangaben

500mA | 5,2W
Material: Aluminium / Stahl



Maßzeichnung

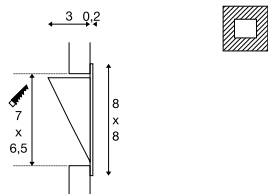

Maßzeichnung

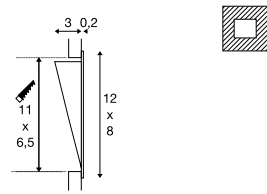

Maßzeichnung

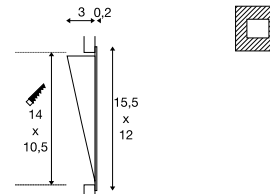

Hinweis

Beim Anschluss mehrerer Leuchten ist auf Reihenschaltung zu achten!
Materialstärke Einbaufäche: 15 mm max
Bei Verwendung von verschiedenen Treibern können die Leuchten mit dem VALETO® System kombiniert werden. / AMP Stecker inkl. / Treiber exkl.



Hinweis

Beim Anschluss mehrerer Leuchten ist auf Reihenschaltung zu achten!
Materialstärke Einbaufäche: 15 mm max
Bei Verwendung von verschiedenen Treibern können die Leuchten mit dem VALETO® System kombiniert werden. / AMP Stecker inkl. / Treiber exkl.



Hinweis

Beim Anschluss mehrerer Leuchten ist auf Reihenschaltung zu achten!
Materialstärke Einbaufäche: 15 mm max
Bei Verwendung von verschiedenen Treibern können die Leuchten mit dem VALETO® System kombiniert werden. / AMP Stecker inkl. / Treiber exkl.



Zubehöreffehung

- LED Treiber 350mA | 10W
Art. Nr. 464140 
- LED Treiber 350mA | 9W
Art. Nr. 464109 
- Einbaurahmen
Art. Nr. 151960 

Zubehöreffehung

- LED Treiber 15W | 350mA mit Zugentlastung
Art. Nr. 464143 
- LED Treiber 350mA | 9W
Art. Nr. 464109 
- Einbaurahmen
Art. Nr. 151961 

Zubehöreffehung

- LED Treiber 500mA | 15W dimmbar
Art. Nr. 464144 
- LED Treiber 500mA | 9W
Art. Nr. 464091 
- Einbaurahmen
Art. Nr. 151962 

Variante	Art. Nr.
180lm 3000K CRI>80 <input type="checkbox"/> weiß	151950

Variante	Art. Nr.
160lm 3000K CRI>80 <input type="checkbox"/> weiß	151951

Variante	Art. Nr.
230lm 3000K CRI>80 <input type="checkbox"/> weiß	151952

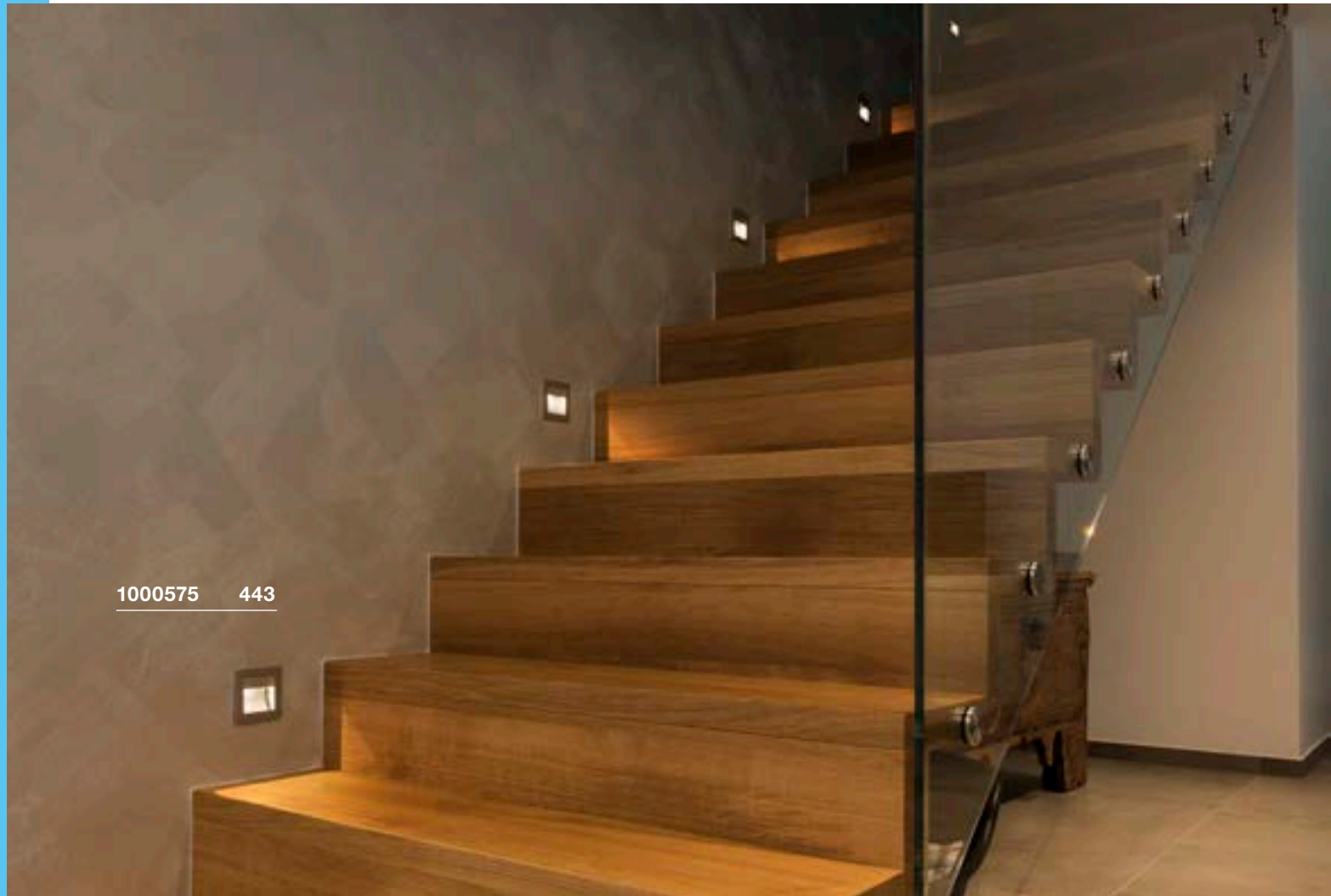

1000575 443

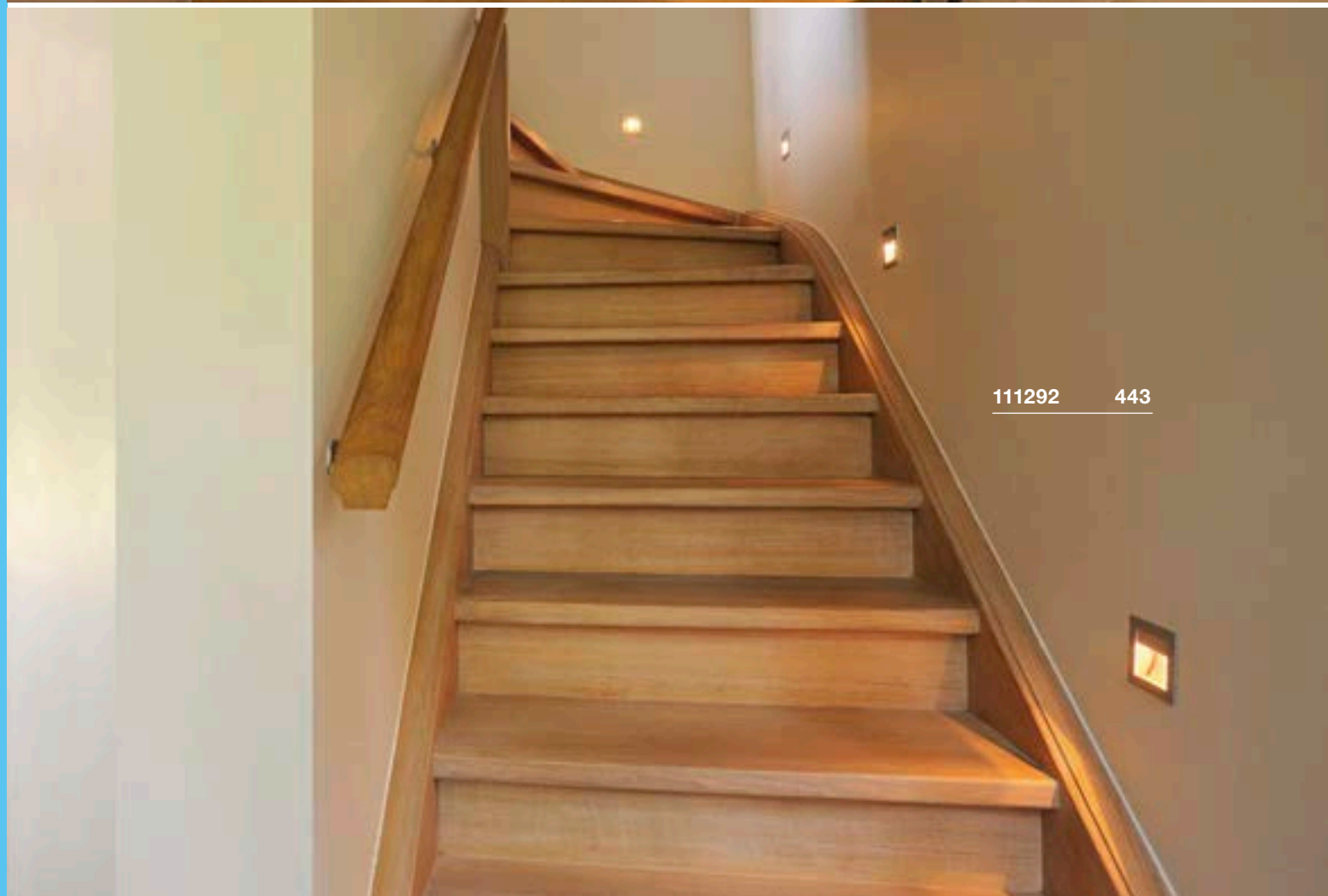

111292 443

FLAT FRAME CURVE EL, QT9



Produktangaben

12V ~50/60Hz
Material: Aluminium

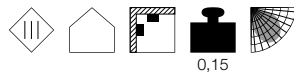

Maßzeichnung

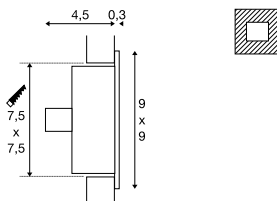

Hinweis

Materialstärke Einbaufäche: 10-25 mm max
Maßzeichnung links mit Einbaudose

Zubehörempfehlung

- Transformator 12V AC | 60VA
Art. Nr. 461060
- Einbaudose
Art. Nr. 112781
- Unterputzrahmen
Art. Nr. 112780

Leuchtmittelangaben

max. 20W QT9

Variante	Art. Nr.
G4 QT9 <input type="checkbox"/> matt weiß	112771
G4 QT9 <input checked="" type="checkbox"/> grau	112772

FRAME CURVE EL, HV

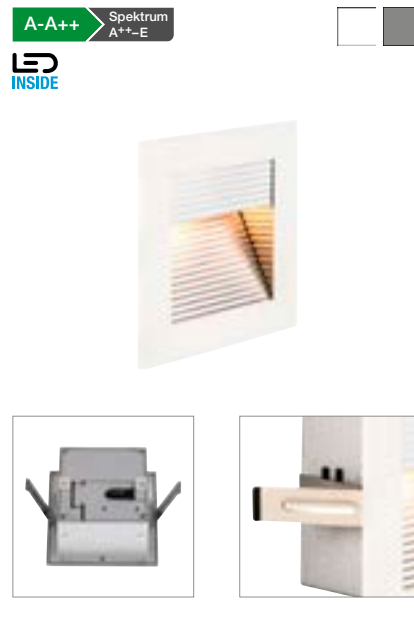

Produktangaben

100-277V ~50/60Hz | 350mA
Systemleistung: 3,1W
Material: Aluminium

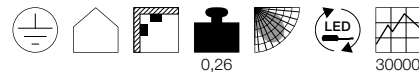

Maßzeichnung

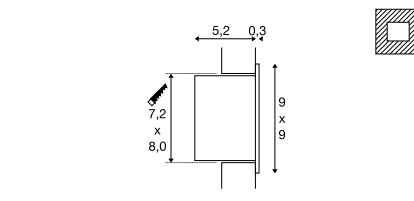

Hinweis

Materialstärke Einbaufäche: 10-30 mm

Zubehörempfehlung

- Einbaudose
Art. Nr. 112781
- Unterputzrahmen
Art. Nr. 112780

Variante	Art. Nr.
100lm 2700K CRI>80 <input type="checkbox"/> weiß	1000574
100lm 2700K CRI>80 <input checked="" type="checkbox"/> grau	1000575

FRAME CURVE EL



Produktangaben

350mA | 1W
Material: Aluminium



Maßzeichnung

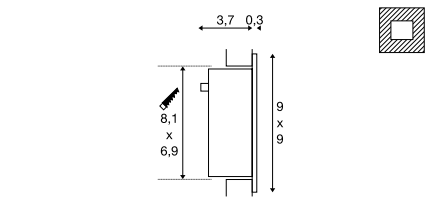

Hinweis

Materialstärke Einbaufäche: 10-30 mm max
Beim Anschluss mehrer Leuchten ist auf
Reihenschaltung zu achten!
Bei Verwendung von verschiedenen Treibern
können die Leuchten mit dem VALETO® System
kombiniert werden.
AMP Stecker inkl. / Treiber exkl.

Zubehörempfehlung

- LED Treiber 350mA | 3W
Art. Nr. 464107
- Einbaudose
Art. Nr. 112781
- Unterputzrahmen
Art. Nr. 112780
- Steckerleiste 3 Ausgänge
Art. Nr. 111850

Variante	Art. Nr.
60lm 4000K CRI>80 <input checked="" type="checkbox"/> grau	111290
60lm 3000K CRI>80 <input checked="" type="checkbox"/> grau	111292
60lm 4000K CRI>80 <input type="checkbox"/> matt weiß	113290
60lm 3000K CRI>80 <input type="checkbox"/> matt weiß	113292

FLAT FRAME BASIC EL, QT9

C-A+ Spektrum
A++-E

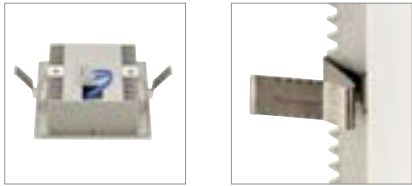

Produktangaben

12V ~50/60Hz
Material: Aluminium / Glas

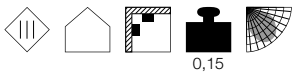

0,15

Maßzeichnung

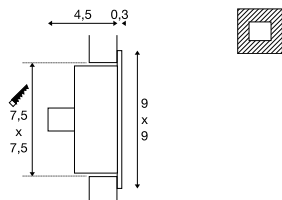

Hinweis

Materialstärke Einbaufäche: 10-25 mm max

Zubehörempfehlung

- Transformator 12V AC | 60VA
Art. Nr. 461060
- Einbaudose
Art. Nr. 112781
- Unterputzrahmen
Art. Nr. 112780



Leuchtmittelangaben

max. 20W QT9

Variante	Art. Nr.
G4 QT9 <input type="checkbox"/> matt weiß	112731
G4 QT9 <input checked="" type="checkbox"/> grau	112732

FRAME BASIC EL, HV

A-A++ Spektrum
A+++-E

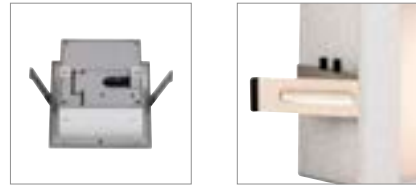

Produktangaben

100-277V ~50/60Hz | 350mA
Systemleistung: 3,1W
Material: Aluminium

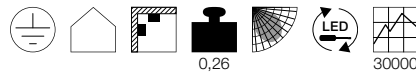

0,26

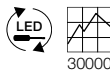

30000



250

Maßzeichnung

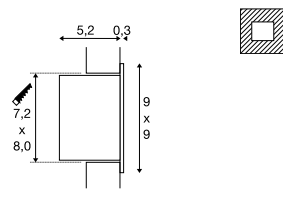

Hinweis

Materialstärke Einbaufäche: 10-30 m

Zubehörempfehlung

- Unterputzrahmen
Art. Nr. 112780
- Einbaudose
Art. Nr. 112781



FRAME BASIC EL

A-A++ Spektrum
A++-E



- Einsatz von Dias und Folien möglich

Produktangaben

350mA | 1W
Material: Aluminium / Glas

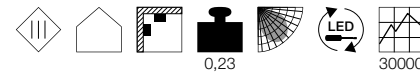

0,23

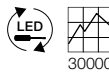

30000

Maßzeichnung

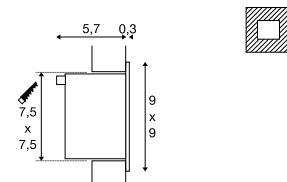

Hinweis

Materialstärke Einbaufäche: 10-30 mm max
Beim Anschluss mehrer Leuchten ist auf Reihenschaltung zu achten!
Bei Verwendung von verschiedenen Treibern können die Leuchten mit dem VALETO® System kombiniert werden.
AMP Stecker inkl. / Treiber exkl.
Materialstärke Einbaufäche: 10-30 m

Zubehörempfehlung

- LED Treiber 350mA | 3W
Art. Nr. 464107
- Unterputzrahmen
Art. Nr. 112780
- Einbaudose
Art. Nr. 112781
- Steckerleiste 3 Ausgänge
Art. Nr. 111850



Variante	Art. Nr.
45lm 4000K CRI>80 <input checked="" type="checkbox"/> grau	111260
40lm 3000K CRI>80 <input checked="" type="checkbox"/> grau	111262
45lm 4000K CRI>80 <input type="checkbox"/> matt weiß	113260
40lm 3000K CRI>80 <input type="checkbox"/> matt weiß	113262



1002922 445

MOBALA EL

A-A++ Spektrum A++-E



Produktangaben

100-240V ~50/60Hz | 24V DC
Systemleistung: 1,3W
Material: Aluminium



Maßzeichnung

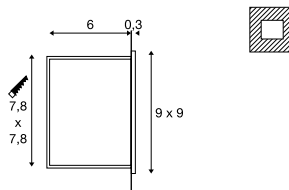

Zubehörempfehlung

- Einbaudose
Art. Nr. 1002983
- Einbaurahmen
Art. Nr. 1002984

Variante	Art. Nr.
14lm 3000K CRI>80 □ matt weiß	1002982

WORD EL

A-A++ Spektrum A++-E



Produktangaben

350mA | 1,1W
Material: Stahl



Maßzeichnung

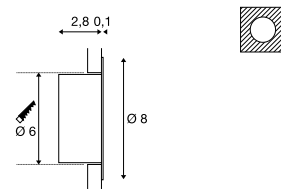

Hinweis

Beim Anschluss mehrerer Leuchten ist auf Reihenschaltung zu achten!
Der Artikel ist für die Installation in Hohlwand- und Unterputzdosen für Schalter/Steckdosen geeignet.
Offenes Kabelend

Zubehörempfehlung

- LED Treiber 350mA | 9W
Art. Nr. 464109

Variante	Art. Nr.
50lm 3000K CRI>80 □ matt weiß	1002922

BEDSIDE
EL, left

A-A++ Spektrum A++-E





- „Dip-it“ – Schalten durch Ausschwenken
- Mit blauem Orientierungslicht im ausgeschalteten Zustand
- Ausführungs links

Produktangaben

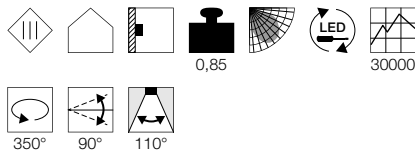
700mA | 3W
Material: Aluminium

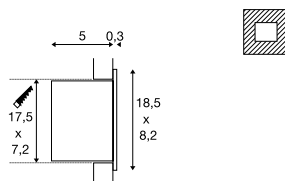

Maßzeichnung



Hinweis

Nicht für Reihenschaltung geeignet.
Betrieb nur mit 3W Treiber (464200).
Materialstärke Einbaufäche: 20 mm max

Zubehörempfehlung

□ LED Treiber 700mA | 3W inkl. Zugentlastung
Art. Nr. 464200



■ Einbaudose
Art. Nr. 146260



Variante	Art. Nr.
110lm 3000K CRI>80	
■ grau	146242

BEDSIDE
EL, right

A-A++ Spektrum A++-E

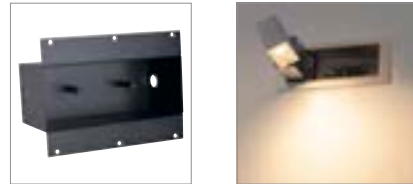
- „Dip-it“ – Schalten durch Ausschwenken
- Mit blauem Orientierungslicht im ausgeschalteten Zustand
- Ausführungs rechts

Produktangaben

700mA | 3W
Material: Aluminium

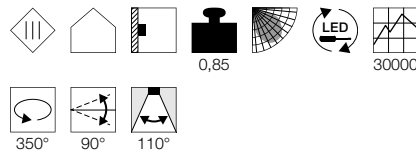

Maßzeichnung

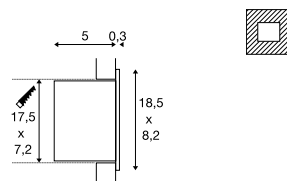

Hinweis

Nicht für Reihenschaltung geeignet.
Betrieb nur mit 3W Treiber (464200).
Materialstärke Einbaufäche: 20 mm max

Zubehörempfehlung

□ LED Treiber 700mA | 3W inkl. Zugentlastung
Art. Nr. 464200



■ Einbaudose
Art. Nr. 146260



Variante	Art. Nr.
110lm 3000K CRI>80	
■ grau	146252



146242 446

146242 446



152381 447

KARPO 30 EL



A-A++ Spektrum A++-E



- Premium LED mit CRI>90

Produktangaben

500mA | 7,5W
Material: Aluminium / Stahl

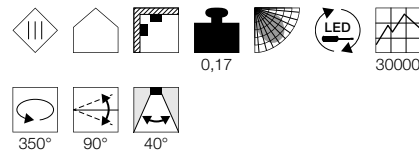

Maßzeichnung

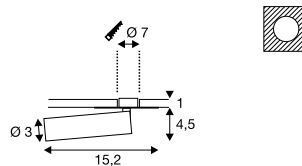

Hinweis

Materialstärke Einbaulfläche: 12 mm max
Beim Anschluss mehrerer Leuchten ist auf Reihenschaltung zu achten!
Bei Verwendung von verschiedenen Treibern können die Leuchten mit dem VALETO® System Kombiniert werden.
Treiber exkl.

Zubehörempfehlung

LED Treiber 500mA | 9W
Art. Nr. 464091



Variante	Art. Nr.
450lm 3000K CRI>90	
■ schwarz	152380
470lm 3000K CRI>90	
<input type="checkbox"/> weiß	152381

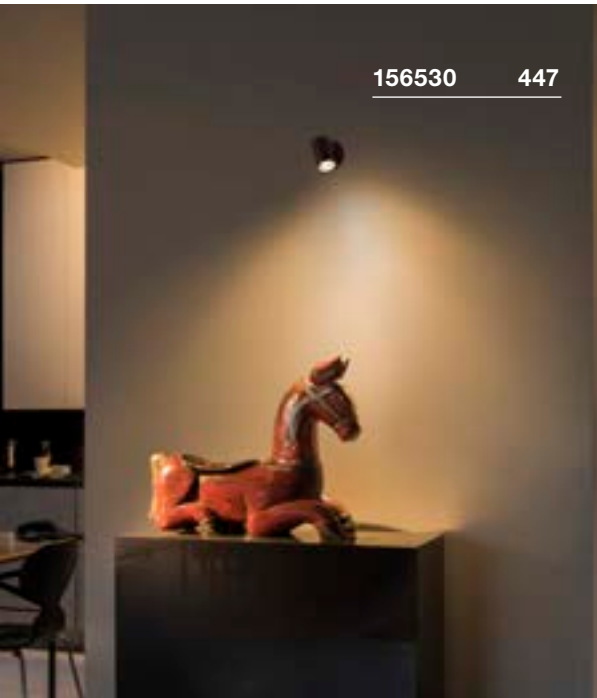

156530 447

HELIA EL



A-A++ Spektrum A++-E



- Premium LED mit CRI>90
- Geringe Einbautiefe

Produktangaben

500mA | 9W
Material: Aluminium

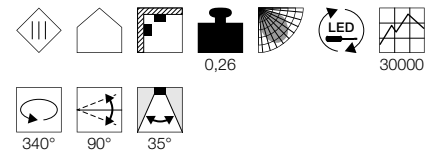

Maßzeichnung

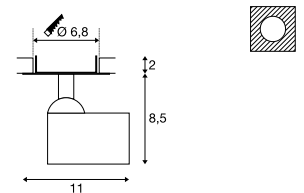

Hinweis

Materialstärke Einbaulfläche: 15 mm

Zubehörempfehlung

LED Treiber 500mA | 9W
Art. Nr. 464091



Variante	Art. Nr.
700lm 3000K CRI>90	
■ schwarz	156530
800lm 3000K CRI>90	
<input type="checkbox"/> weiß	156531

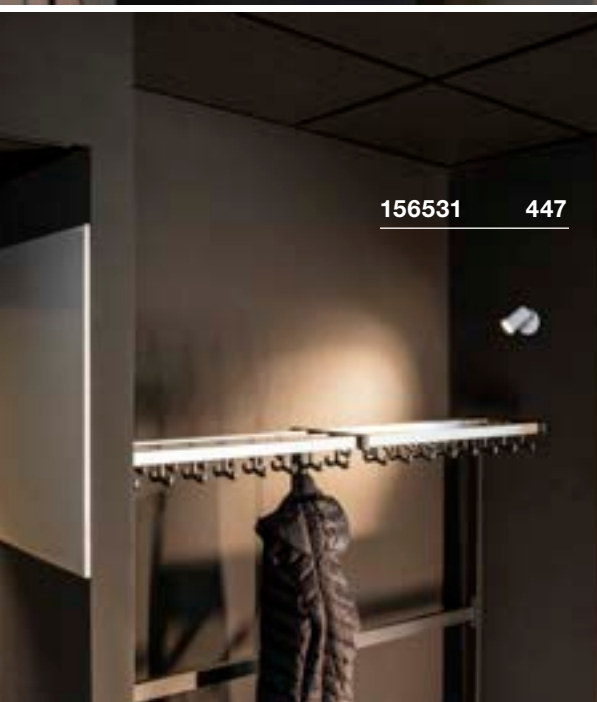

156531 447

LIGHTPOINT
ELA-A++ Spektrum
A++-E

1001156 448

Produktangaben

350mA | 1W

Material: Aluminium / Polymethylacrylat (PMMA)



Maßzeichnung

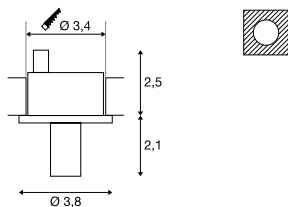

Zubehörempfehlung

Steckerleiste 3 Ausgänge

Art. Nr. 111850



LED Treiber 350mA | 3W

Art. Nr. 464107



Variante	Art. Nr.
100lm 3000K CRI>80 weiß	1001156
100lm 3000K CRI>80 chrom	1001155





1002120 449

CRYSTAL
EL, TRIACA-A++ Spektrum
A++-ELED
INSIDE

- Premium LED mit CRI>90
- Dim to Warm (1800-3000K)

Produktangaben

220-240V ~50/60Hz | 350mA
 Systemleistung: 7,3W
 Material: Aluminium / Glas
 Dimmbar: Triac C, Triac L

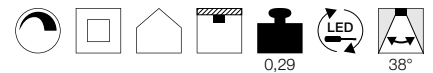

Maßzeichnung

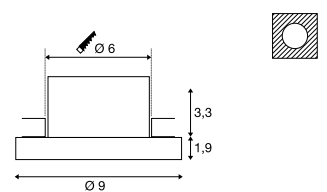

Hinweis

Produkte werden mit Clipfedern geliefert.
 Blattfedern liegen dem Produkt bei
 und können ausgetauscht werden.
 Materialstärke Einbaufäche: 20 mm

Ein Anwendungsvideo zu
 Dim to Warm finden Sie unter
<http://bit.ly/dim-to-warm>



Variante	Art. Nr.
460lm 1800-3000K CRI>95 □ transparent	1002120

DEKLED
EL

A-A++ Spektrum A++-E

LED INSIDE

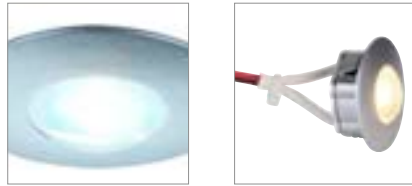

DL 126
EL

A-A++ Spektrum A++-E

LED INSIDE

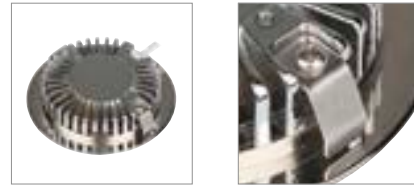

Produktangaben

350mA | 1W
Material: Aluminium / Polycarbonat (PC)

Maßzeichnung

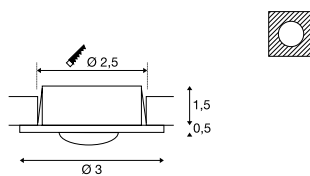

Produktangaben

12V DC | 2,8W
Material: Aluminium / Kunststoff

Maßzeichnung

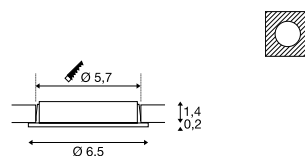

Zubehörempfehlung

LED Treiber 320mA | 3W inkl. Zugentlastung
Art. Nr. 464108



Zubehörempfehlung

LED Netzteil 12V DC | 12W
Art. Nr. 470507



Variante	Art. Nr.
60lm 4000K CRI>80	
■ grau	112240
60lm 3000K CRI>80	
■ grau	112242

Variante	Art. Nr.
160lm 3000K CRI>80	
□ weiß	112221
160lm 3000K CRI>80	
■ chrom	112222
160lm 3000K CRI>80	
■ matt grau	112225
160lm 2700K CRI>80	
□ weiß	112161
160lm 2700K CRI>80	
■ chrom	112162
160lm 2700K CRI>80	
■ matt grau	112165

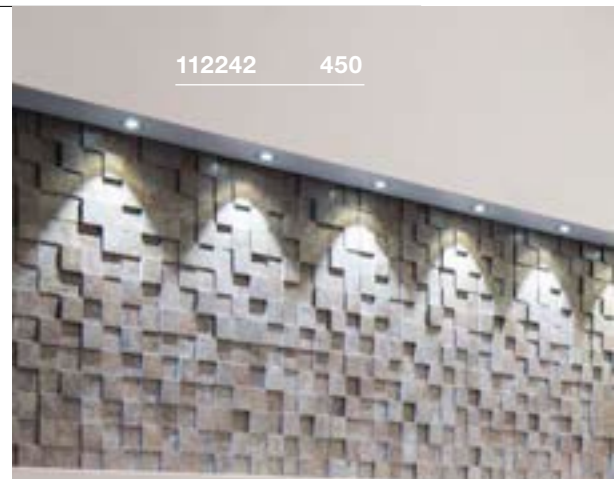



112161 450

FRAME BASIC SET EL

A-A++ Spektrum A++-E

LED INSIDE

NEW COLOR

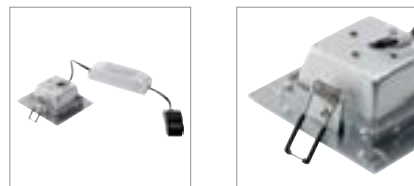

Produktangaben

220-240V ~50/60Hz | 350mA
 Systemleistung: 8,6W
 Material: Aluminium / Acryl

0,2 56000

90°

Maßzeichnung

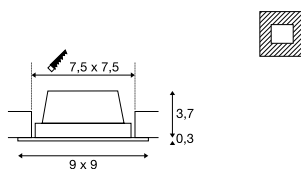

Hinweis

Clipfedern
 Materialstärke Einbaufäche: 20 mm max



112720 451

INDI REC EL, QPAR51

E-A++ Spektrum A++-E

NEW COLOR



Produktangaben

220-240V ~50/60Hz
 Material: Aluminium / Stahl

0,34 30° 30°

Maßzeichnung

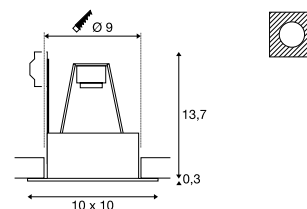

Hinweis

Materialstärke Einbaufäche: 25 m

Leuchtmittlempfehlung

LED GU10 5,5W 38°
 2700K 400lm EEK=A+
 6kWh/1000h
 Art. Nr. 1001030



LED GU10 7,2W 36°
 2700K 570lm EEK=A+
 8kWh/1000h
 Art. Nr. 560552



Leuchtmittelangaben

max. 20W QPAR51

Variante	Art. Nr.
445lm 3000K CRI>80	
■ matt schwarz	112720
445lm 3000K CRI>80	
□ matt weiß	112721
445lm 3000K CRI>80	
■ matt aluminium	112726

Variante	Art. Nr.
GU10 QPAR51	
■ matt schwarz	1002857
GU10 QPAR51	
□ matt weiß	112471
GU10 QPAR51	
■ grau / schwarz	112474

KAHOLO
EL, E27E-A++ Spektrum
A++-E

- Bestückbar mit verschiedensten E27 Leuchtmitteln
- Höhenverstellbare Fassung

Produktangaben

230V ~50Hz
Material: Aluminium / Stahl

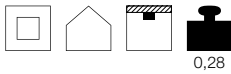

Maßzeichnung

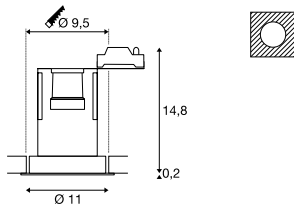

Hinweis

Materialstärke Einbaufäche: 20 mm max

Leuchtmittlempfehlung

LED E27 11,5W 240°
2700K 1060lm EEK=A+
12kWh/1000h | 3 Step-Dim
Art. Nr. 560432



LED E27 9,5W 240°
2200-6700K 806lm EEK=A+
10kWh/1000h
Art. Nr. 1001917



Variante	Art. Nr.
E27 PAR20	
■ schwarz	1000906
E27 PAR20	
□ weiß	1000907
E27 PAR20	
■ matt aluminium	1000908

1000906 452

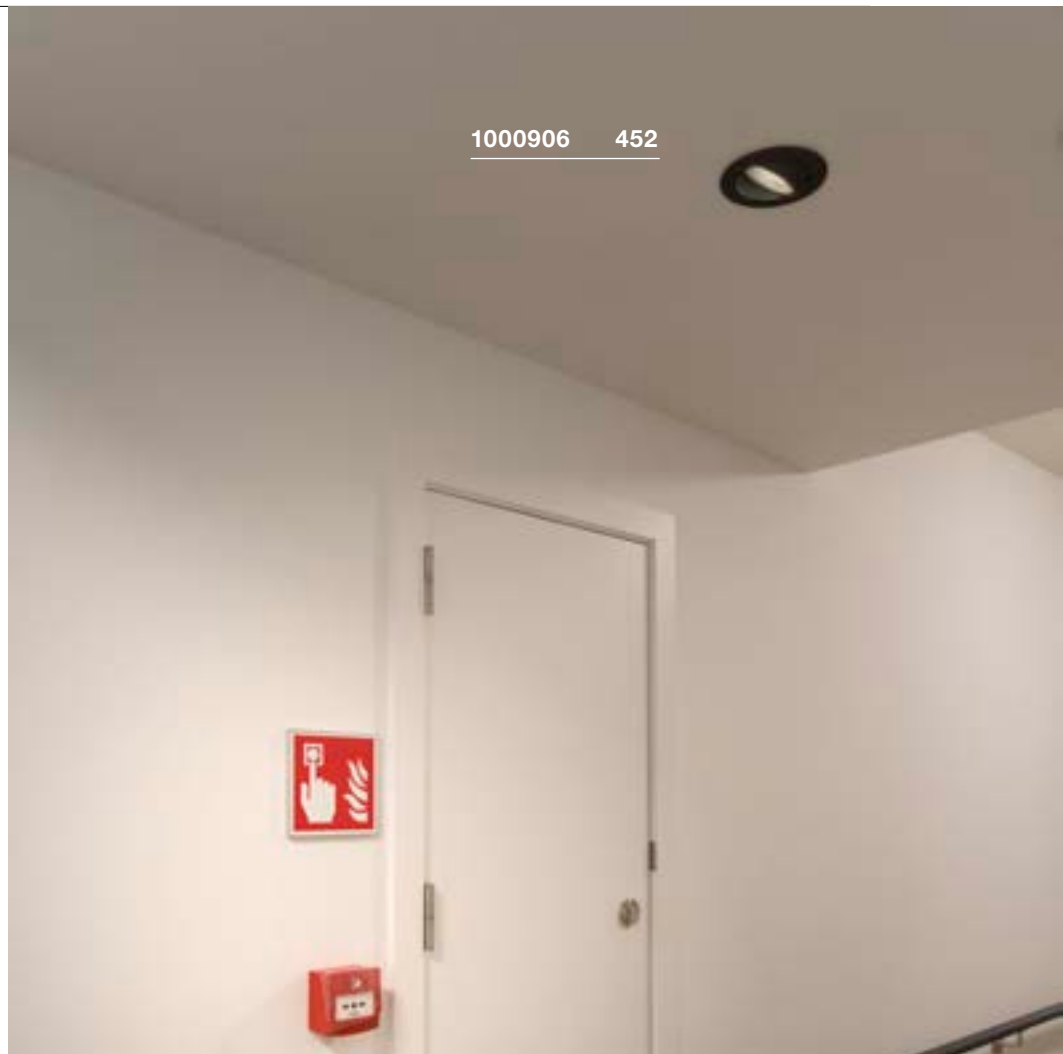

1000907 452





148070 453

PLASTRA
EL, round, QPAR51



E-A++ Spektrum A++-E

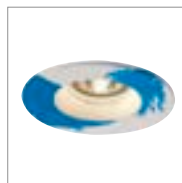

- Deckenbündige Montage möglich
- Individuell gestaltbar mit Farben, Stickern & mehr

Produktangaben

220-240V ~50/60Hz
Material: Gips / Stahl

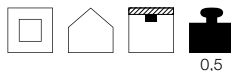

148071 453

PLASTRA
EL, square, QPAR51



E-A++ Spektrum A++-E



- Deckenbündige Montage möglich
- Individuell gestaltbar mit Farben, Stickern & mehr

Produktangaben

220-240V ~50/60Hz
Material: Gips / Stahl

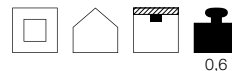

Maßzeichnung

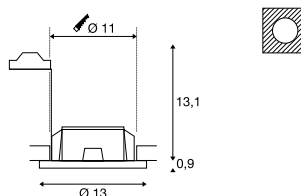

Hinweis

Materialstärke Einbaufäche: 25 mm max

Leuchtmittlempfehlung

GU10 5,5W 36°
2800K 420lm EEK=A+
6kWh/1000h
Art. Nr. 1001217



LED GU10 5,1W 48°
2700-6500K 350lm EEK=A+
6kWh/1000h
Art. Nr. 1001918



Leuchtmittelangaben

max. 35W QPAR51

Variante	Art. Nr.
GU10 QPAR51	
<input type="checkbox"/> weiß	148070

Maßzeichnung

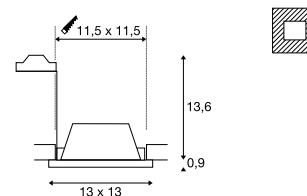

Hinweis

Materialstärke Einbaufäche: 25 mm max

Leuchtmittlempfehlung

LED GU10 5,5W 38°
2700K 400lm EEK=A+
6kWh/1000h
Art. Nr. 1001030



LED GU10 7,2W 36°
2700K 570lm EEK=A+
8kWh/1000h
Art. Nr. 560552



Leuchtmittelangaben

max. 35W QPAR51

Variante	Art. Nr.
GU10 QPAR51	
<input type="checkbox"/> weiß	148071

PIKA
EL, round, QPAR51, starr

E-A++ Spektrum
A++-E



- 3-Pole Loop-In/Loop-Out (zur Durchverdrahtung)

Produktangaben

230V ~50Hz
Material: Aluminium

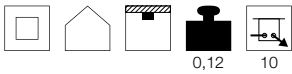

Maßzeichnung

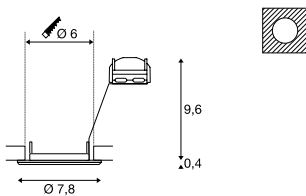

Hinweis

Materialstärke Einbaufäche: 13 mm max

Leuchtmittlempfehlung

GU10 5,5W 36°
2800K 420lm EEK=A+
6kWh/1000h
Art. Nr. 1001217



LED GU10 5,5W 38°
2700K 400lm EEK=A+
6kWh/1000h
Art. Nr. 1001030



Leuchtmittelangaben

max. 50W QPAR51

Variante	Art. Nr.
GU10 QPAR51 □ weiß	1000714
GU10 QPAR51 ■ chrom	1000715
GU10 QPAR51 ■ messing	1000716
GU10 QPAR51 ■ grau	1000717



1000718 455

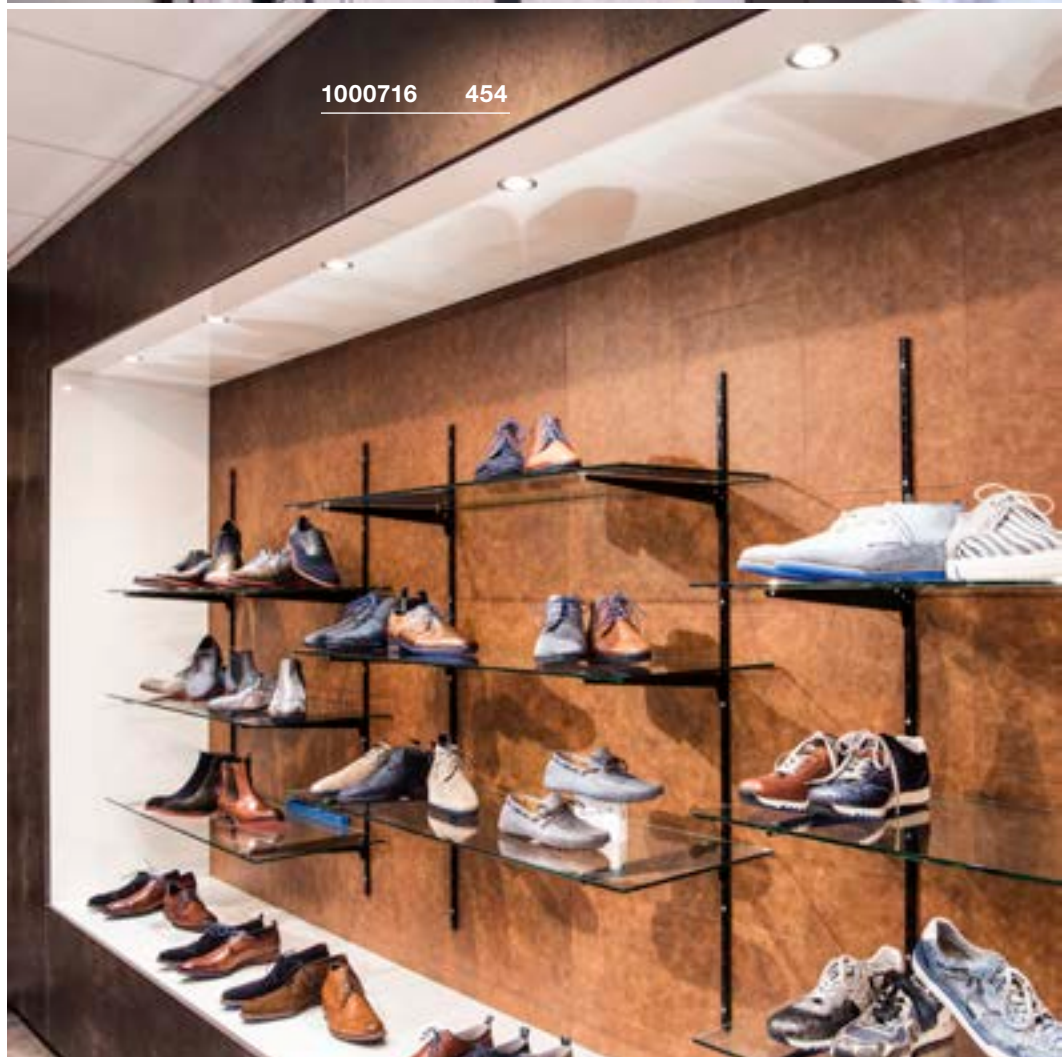

1000716 454

PIKA
EL, round, QPAR51



- 3-Pole Loop-In/Loop-Out (zur Durchverdrahtung)
- Leuchteneinheit 30° Schwenkbar

Produktangaben

230V ~50Hz
Material: Aluminium



Maßzeichnung

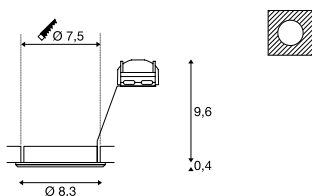

Hinweis

Materialstärke Einbaufäche: 15 mm max

Leuchtmittlempfehlung

- LED GU10 5,5W 38°
2700K 400lm EEK=A+
6kWh/1000h
Art. Nr. 1001030
- LED GU10 7,2W 36°
2700K 570lm EEK=A+
8kWh/1000h
Art. Nr. 560552

Leuchtmittelangaben

max. 50W QPAR51

Variante	Art. Nr.
GU10 QPAR51 □ weiß	1000718
GU10 QPAR51 ■ chrom	1000719
GU10 QPAR51 ■ messing	1000720
GU10 QPAR51 ■ grau	1000721

PIKA
EL, square, QPAR51, starr



- 3-Pole Loop-In/Loop-Out (zur Durchverdrahtung)

Produktangaben

230V ~50Hz
Material: Aluminium

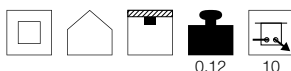

Maßzeichnung

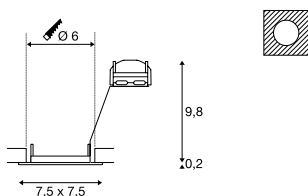

Hinweis

Materialstärke Einbaufäche: 13 mm max

Leuchtmittlempfehlung

- LED GU10 5,5W 38°
2700K 400lm EEK=A+
6kWh/1000h
Art. Nr. 1001030
- LED GU10 7,2W 36°
2700K 570lm EEK=A+
8kWh/1000h
Art. Nr. 560552

Leuchtmittelangaben

max. 50W QPAR51

Variante	Art. Nr.
GU10 QPAR51 □ weiß	1002204
GU10 QPAR51 ■ chrom	1002205
GU10 QPAR51 ■ messing	1002206
GU10 QPAR51 ■ grau	1002207

PIKA
EL, square, QPAR51, schwenkbar



- 3-Pole Loop-In/Loop-Out (zur Durchverdrahtung)
- Leuchteneinheit 30° Schwenkbar

Produktangaben

230V ~50Hz
Material: Aluminium

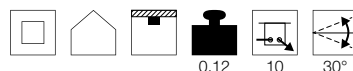

Maßzeichnung

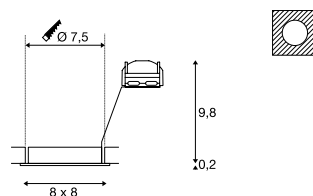

Hinweis

Materialstärke Einbaufäche: 15 mm max

Leuchtmittlempfehlung

- GU10 5,5W 36°
2800K 420lm EEK=A+
6kWh/1000h
Art. Nr. 1001217
- LED GU10 5,1W 48°
2700-6500K 350lm EEK=A+
6kWh/1000h
Art. Nr. 1001918

Leuchtmittelangaben

max. 50W QPAR51

Variante	Art. Nr.
GU10 QPAR51 □ weiß	1002208
GU10 QPAR51 ■ chrom	1002209
GU10 QPAR51 ■ messing	1002210
GU10 QPAR51 ■ grau	1002211

1003036 457



161301 457



161271 457

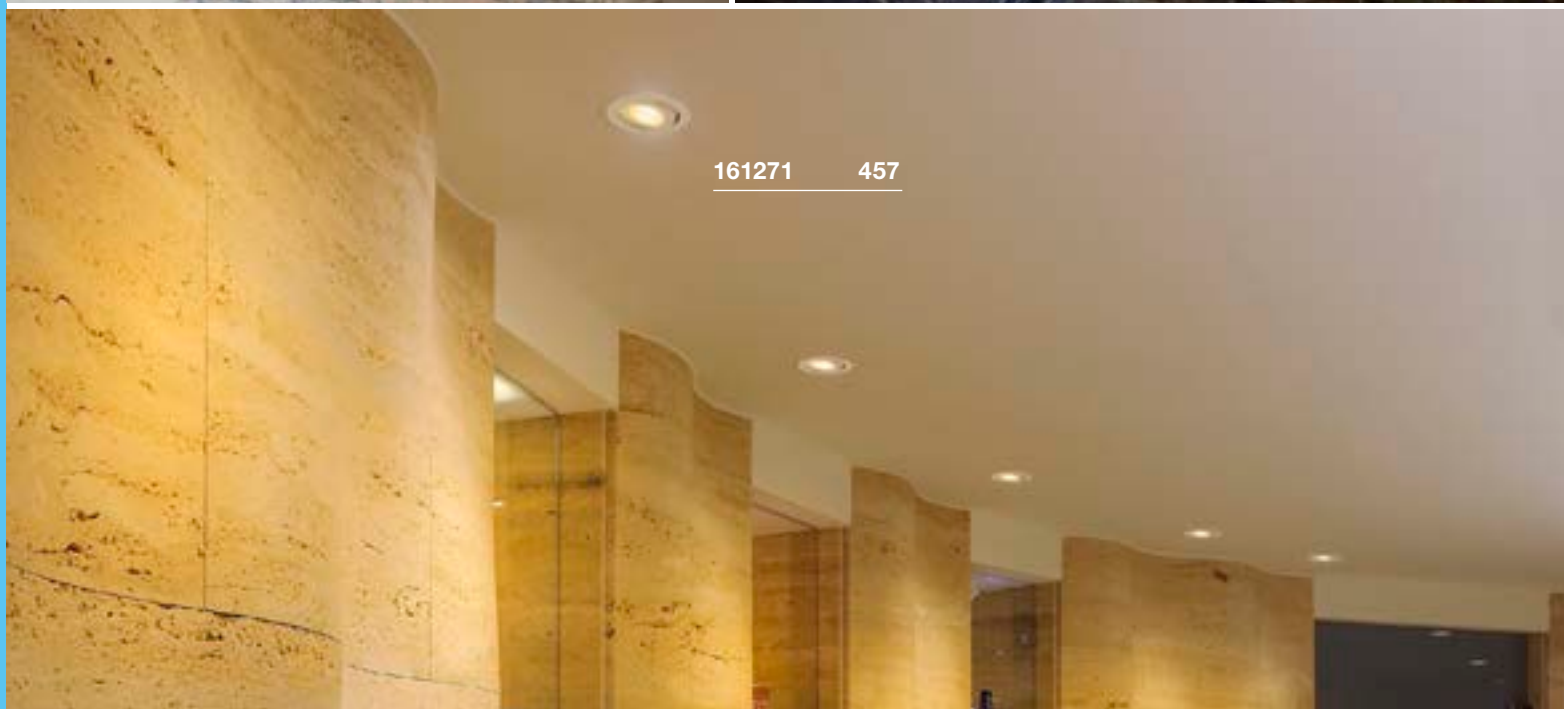

CONTONE®
EL, round/square, verstellbar, TRIAC



- Premium LED mit CRI>90
- Lichtfarbe ändert sich durch Dimmen

Produktangaben

220-240V ~50/60Hz | 350mA
Systemleistung: 16W
Material: Aluminium
Dimmbar: Triac C, Triac L

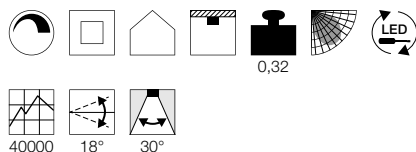

Maßzeichnung

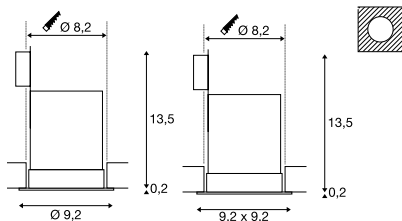

Hinweis

Materialstärke Einbaufäche: 25 mm max

Ein Anwendungsvideo zu Dim to Warm finden Sie un er <http://bit.ly/dim-to-warm>



Variante	Art. Nr.
890lm 2000K-3000K CRI>90	
○ □ weiß	161271
890lm 2000K-3000K CRI>90	
□ □ weiß	161281

CONTONE®
EL, round/square, starr, TRIAC



- Premium LED mit CRI>90
- Lichtfarbe ändert sich durch Dimmen

Produktangaben

220-240V ~50/60Hz | 350mA
Systemleistung: 16W
Material: Aluminium
Dimmbar: Triac C, Triac L

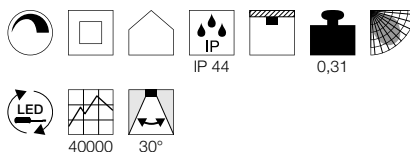

Maßzeichnung

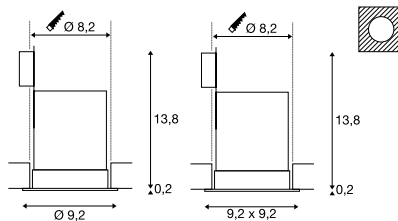

Hinweis

Materialstärke Einbaufäche: 25 mm max

Ein Anwendungsvideo zu Dim to Warm finden Sie un er <http://bit.ly/dim-to-warm>



Variante	Art. Nr.
890lm 2000K-3000K CRI>90	
○ □ weiß	161291
890lm 2000K-3000K CRI>90	
□ □ weiß	161301

DINGILO
EL, round, verstellbar, TRIAC

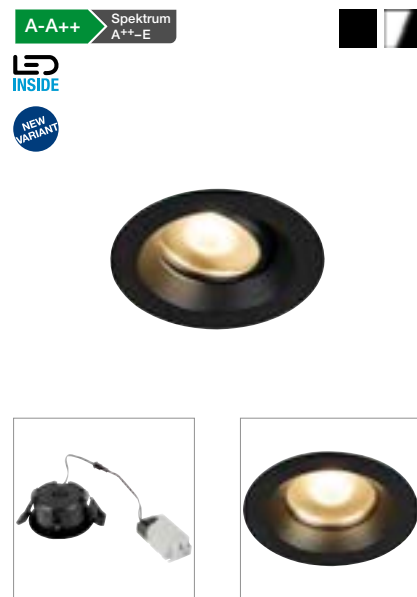

- Premium LED mit CRI>90

Produktangaben

100-277V ~50/60Hz | 200mA
Systemleistung: 4,4W
Material: Aluminium / Kunststoff

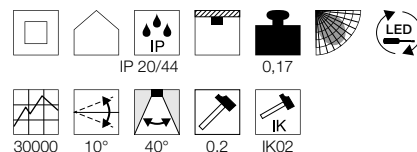

Maßzeichnung

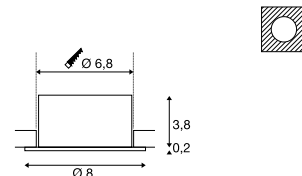

Hinweis

Materialstärke Einbaufäche: 25 mm max

Variante	Art. Nr.
330lm 2700K CRI>90	
■ matt schwarz / matt schwarz	1003036
330lm 2700K CRI>90	
■ matt weiß / matt schwarz	1003037
330lm 3000K CRI>90	
■ matt schwarz / matt schwarz	1003038
330lm 3000K CRI>90	
■ matt weiß / matt schwarz	1003039

H-LIGHT
EL, round, TRIAC



- Enge rotationssymmetrische Lichtverteilung zur akzentuierten Ausleuchtung
- Erzeugung von konturierten Lichtkegeln auf vertikalen Flächen

Produktangaben

220-240V ~50/60Hz | 500mA
Systemleistung: 11W
Material: Aluminium
Dimmbar: Triac C, Triac L

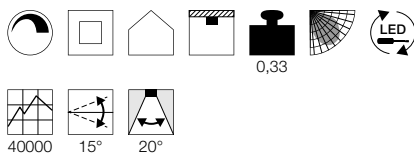

Maßzeichnung

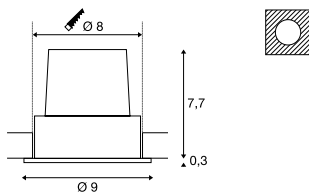

Hinweis

Materialstärke Einbaufäche: 30 mm max
Anschlussbox inkl.

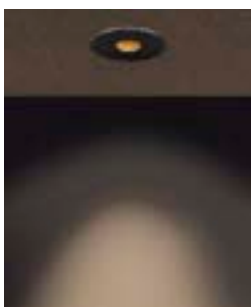

Variante	Art. Nr.
265lm 2700K CRI>80 ■ matt schwarz	114480
265lm 2700K CRI>80 □ matt weiß	114481

H-LIGHT
EL, oval, TRIAC



- Enge asymmetrische Lichtverteilung zur akzentuierten Ausleuchtung
- Erzeugung von konturierten Lichtkegeln auf vertikalen Flächen

Produktangaben

220-240V ~50/60Hz | 500mA
Systemleistung: 11W
Material: Aluminium
Dimmbar: Triac C, Triac L

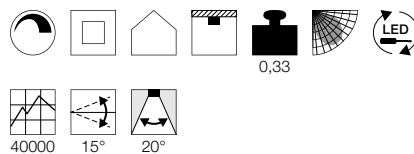

Maßzeichnung

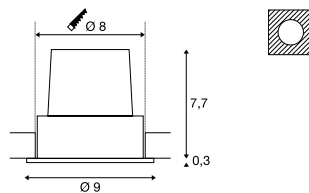

Hinweis

Materialstärke Einbaufäche: 30 mm max
Anschlussbox inkl.



Variante	Art. Nr.
395lm 2700K CRI>80 ■ matt schwarz	114490
395lm 2700K CRI>80 □ matt weiß	114491

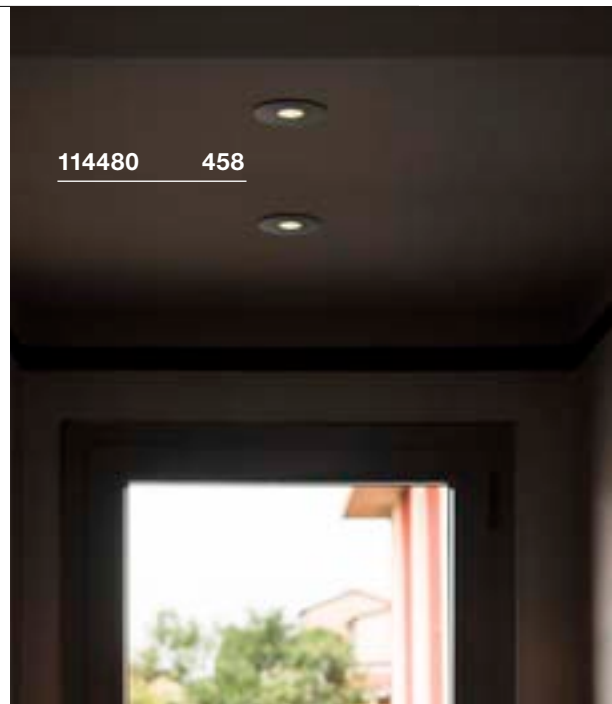

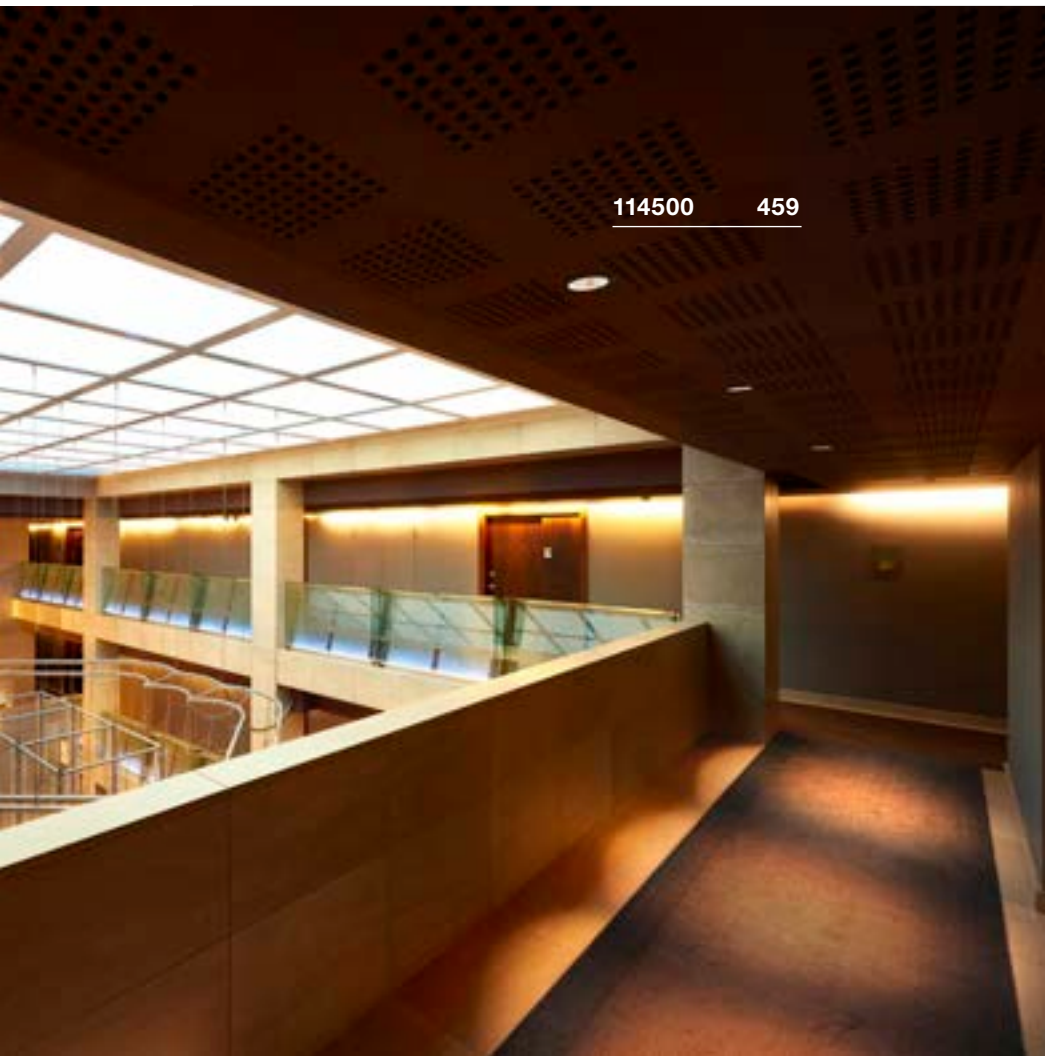

114500 459

H-LIGHT EL, TRIAC

A-A++ Spektrum
A++-E



- Enge rotationsymmetrische Lichtverteilung zur akzentuierten Ausleuchtung
- Erzeugung von konturierten Lichtkegeln auf vertikalen Flächen

Produktangaben

220-240V ~50/60Hz | 500mA
Systemleistung: 11W
Material: Aluminium
Dimmbar: Triac C, Triac L

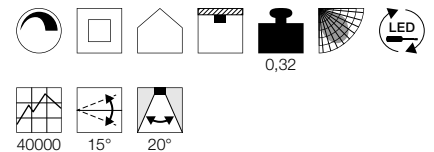

Maßzeichnung

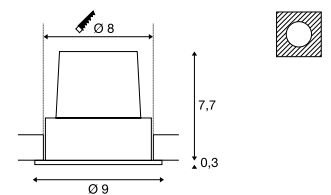

Hinweis

Materialstärke Einbaufäche: 30 mm max
Anschlussbox inkl.

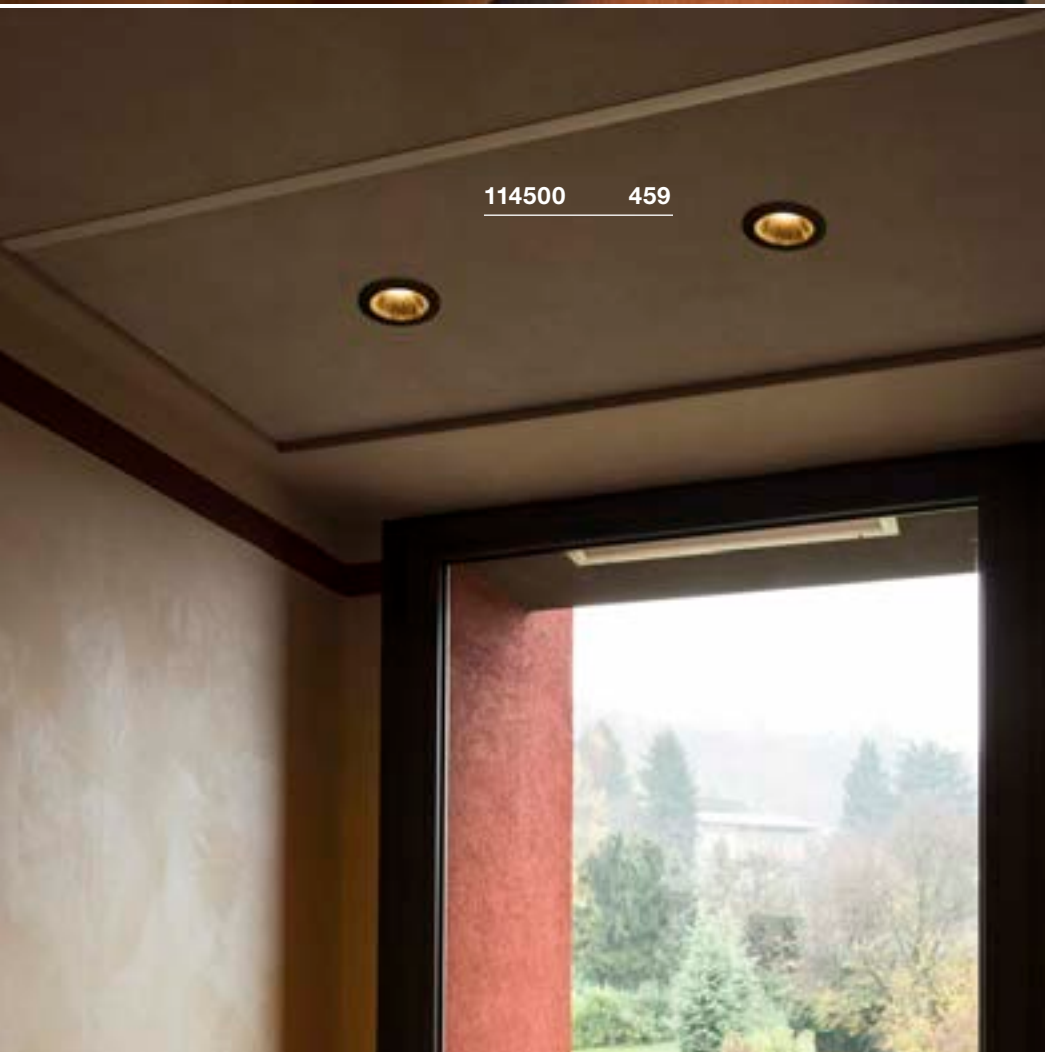
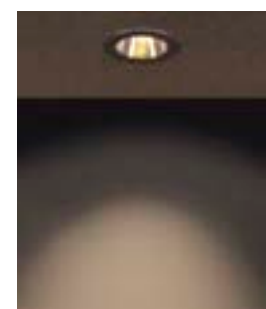

114500 459

Variante	Art. Nr.
540lm 2700K CRI>80	
■ matt schwarz	114500
540lm 2700K CRI>80	
□ matt weiß	114501

DOLIX OUT
EL, round, QR-C51

C-A+ Spektrum A++-E



DOLIX OUT
EL, square, QR-C51

C-A+ Spektrum A++-E

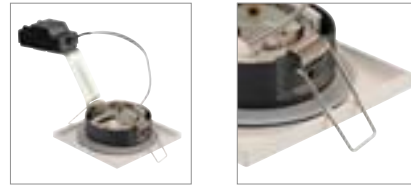

Produktangaben

12V ~50Hz
Material: Aluminium / Glas

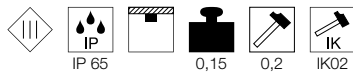

Produktangaben

12V ~50Hz
Material: Aluminium / Glas

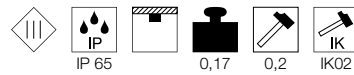

Maßzeichnung

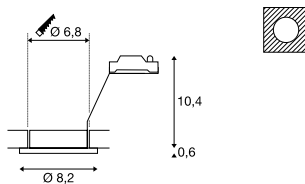

Maßzeichnung

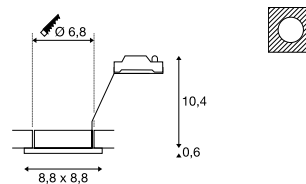

Hinweis

Materialstärke Einbaufäche: 20 mm max

Hinweis

Materialstärke Einbaufäche: 20 mm max

Leuchtmittlempfehlung

LED GU5.3 5,5W 36°
2700K 450lm EEK=A+
7kWh/1000h
Art. Nr. 1001574



Leuchtmittlempfehlung

LED GU5.3 5,5W 36°
2700K 450lm EEK=A+
7kWh/1000h
Art. Nr. 1001574



Leuchtmittelangaben

max. 50W QR-C51

Leuchtmittelangaben

max. 50W QR-C51

Variante	Art. Nr.
GX5.3 QR-C51	
<input type="checkbox"/> weiß	1001157

Variante	Art. Nr.
GX5.3 QR-C51	
<input type="checkbox"/> weiß	1001161

1001157 460





1001166 461



1001172 461

DOLIX OUT
EL, round, QPAR51

E-A++ Spektrum A++-E



Produktangaben

220-240V ~50/60Hz
Material: Aluminium / Glas

Maßzeichnung

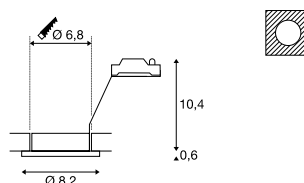

Hinweis

Materialstärke Einbaufäche: 20 mm max

Leuchtmittlempfehlung

LED GU10 5,5W 38°
2700K 400lm EEK=A+
6kWh/1000h

Art. Nr. 1001030

LED GU10 7,2W 36°
3000K 520lm EEK=A+
8kWh/1000h

Art. Nr. 1001562

Leuchtmittelangaben

max. 50W QPAR51

Variante	Art. Nr.
GU10 QPAR51 □ weiß	1001165
GU10 QPAR51 ■ chrom	1001166
GU10 QPAR51 ■ grau / transparent	1001167
GU10 QPAR51 ■ chrom	1001168

DOLIX OUT
EL, square, QPAR51

E-A++ Spektrum A++-E



Produktangaben

220-240V ~50/60Hz
Material: Aluminium / Glas

Maßzeichnung

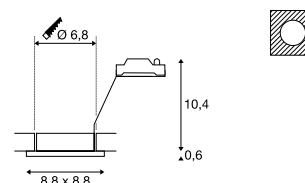

Hinweis

Materialstärke Einbaufäche: 20 mm max

Leuchtmittlempfehlung

LED GU10 5,5W 38°
2700K 400lm EEK=A+
6kWh/1000h

Art. Nr. 1001030

LED GU10 7,2W 36°
3000K 520lm EEK=A+
8kWh/1000h

Art. Nr. 1001562

Leuchtmittelangaben

max. 50W QPAR51

Variante	Art. Nr.
GU10 QPAR51 □ weiß	1001169
GU10 QPAR51 ■ chrom	1001170
GU10 QPAR51 ■ grau / transparent	1001171
GU10 QPAR51 ■ chrom	1001172

VARU
EL, QPAR51

A-A++ Spektrum
A+-E



- Hohe IP Schutzart
- Widerstandsfähiges Gehäuse

Produktangaben

230V~50Hz
Material: Aluminium / Glas

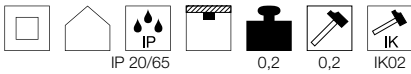

Maßzeichnung

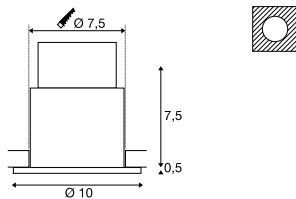

Hinweis

Materialstärke Einbaufäche: 15 mm

Leuchtmittlempfehlung

GU10 5,5W 36°
2800K 420lm EEK=A+
6kWh/1000h
Art. Nr. 1001217



LED GU10 7,2W 36°
2700K 520lm EEK=A+
8kWh/1000h
Art. Nr. 1001560



Leuchtmittelangaben

max. 5W LED GU10 51mm
Ø: 5 cm max. L: 4,6 cm max.

Variante	Art. Nr.
GU10 LED GU10 51mm ■ schwarz	1001930
GU10 LED GU10 51mm □ weiß	1001931

VARU
EL

A-A++ Spektrum
A+-E



- Hohe IP Schutzart
- Widerstandsfähiges Gehäuse
- Blendreduzierung durch rückversetzte LED

Produktangaben

350mA | 5W
Material: Aluminium / Glas

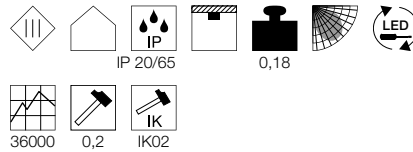

Maßzeichnung

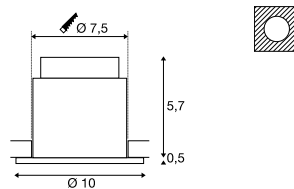

Hinweis

Materialstärke Einbaufäche: 15 mm

Zubehörepfehlung

□ LED Treiber 350mA | 9W
Art. Nr. 464109



Variante	Art. Nr.
400lm 2700K CRI>80 ■ schwarz	1001932
400lm 2700K CRI>80 □ weiß	1001933

1001931 462



1000931 462



KAMUELA ECO EL, round, TRIAC

A-A++ Spektrum
A++-E

LED
INSIDE



- Feuerbeständig für mind. 90 Minuten nach BS 476-21
- LED-Lebensdauer 35.000h
- IP 65 Leuchte mit effizienter LED-Technologie

Produktangaben

220-240V ~50Hz
Systemleistung: 6,5W
Material: Aluminium / Kunststoff
Dimmbar: Triac C, Triac L

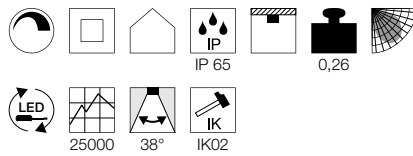

Maßzeichnung

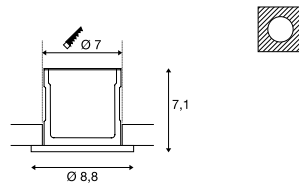

Hinweis

Materialstärke Einbaufäche: 40 mm max

Variante	Art. Nr.
400lm 3000K CRI>80	
■ schwarz	1001015
400lm 3000K CRI>80	
□ weiß	1001016
400lm 4000K CRI>80	
■ schwarz	1001017
400lm 4000K CRI>80	
□ weiß	1001018

1001015 463

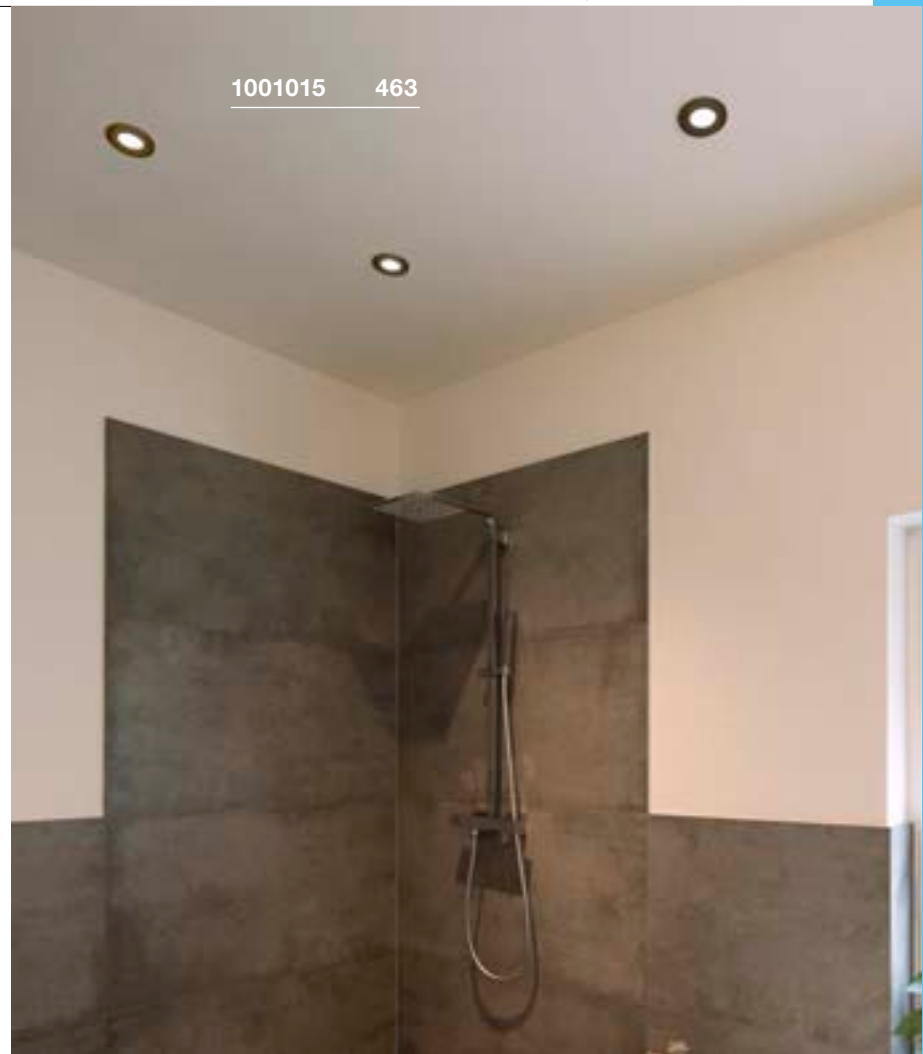

1001017 463



AKALO D83
EL, TRIACA-A++ Spektrum
A++-ELED
INSIDE

NEW



1001264 464



- Durch den rückwärtigen Schalter kann die Lichtfarbe eingestellt werden.

Produktangaben

220-240V ~50/60Hz | 120mA
 Systemleistung: 9W
 Material: Aluminium / Polycarbonat (PC)
 Dimmbar: Triac C

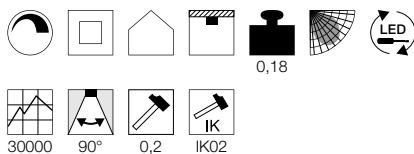

Maßzeichnung

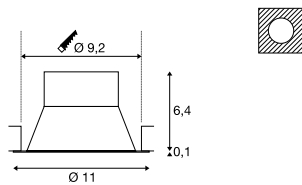

Hinweis

Materialstärke Einbaufäche: 20 m

Variante	Art. Nr.
800/880/850lm 3000/4200/5700K CRI>80	
□ weiß	1001264



114440 465



114440 465

PATTA-F
EL, round, TRIAC

A-A++ Spektrum A++-E



• Hohe IP-Schutzart (vollflächiges Schutzglas)

Produktangaben

220-240V ~50/60Hz | 500mA
Systemleistung: 11W
Material: Aluminium / Glas
Dimmbar: Triac C, Triac L

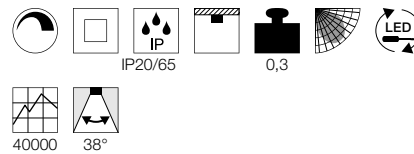

Maßzeichnung

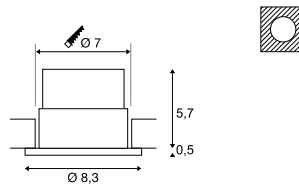

Hinweis

Materialstärke Einbaufäche: 20 m

PATTA-F
EL, square, TRIAC

A-A++ Spektrum A++-E



• Hohe IP-Schutzart (vollflächiges Schutzglas)

Produktangaben

220-240V ~50/60Hz | 500mA
Systemleistung: 11W
Material: Aluminium / Glas
Dimmbar: Triac C, Triac L

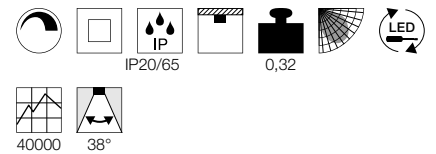

Maßzeichnung

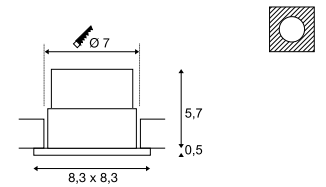

Hinweis

Materialstärke Einbaufäche: 20 m

Variante	Art. Nr.
745lm 3000K CRI>80	
■ schwarz	114440
860lm 3000K CRI>80	
□ weiß	114441

Variante	Art. Nr.
745lm 3000K CRI>80	
■ schwarz	114450
860lm 3000K CRI>80	
□ weiß	114451

PATTA-I
EL, round, TRIAC



- Premium LED mit CRI>90
- Dim to Warm (1800-3000K)
- Hohe IP-Schutzart

Produktangaben

220-240V ~50/60Hz | 350mA
Systemleistung: 7,3W
Material: Aluminium / Glas
Dimmbar: Triac C, Triac L

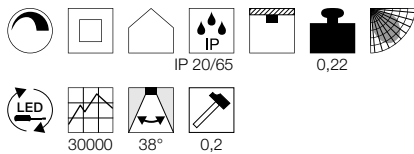

Maßzeichnung

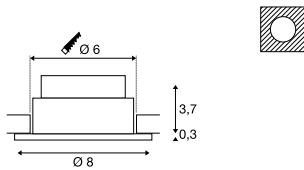

Hinweis

Produkte werden mit Clipfedern geliefert. Blattfedern liegen dem Produkt bei und können ausgetauscht werden. Materialstärke Einbaufäche: 20 m

Ein Anwendungsvideo zu Dim to Warm finden Sie un er <http://bit.ly/dim-to-warm>



PATTA-I
EL, square, TRIAC

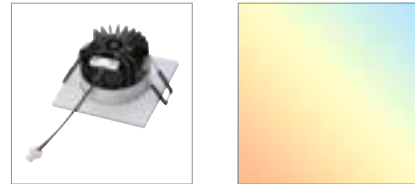

- Premium LED mit CRI>90
- Dim to Warm (1800-3000K)
- Hohe IP-Schutzart

Produktangaben

220-240V ~50/60Hz | 350mA
Systemleistung: 7,3W
Material: Aluminium / Glas
Dimmbar: Triac C, Triac L

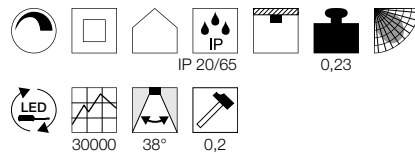

Maßzeichnung

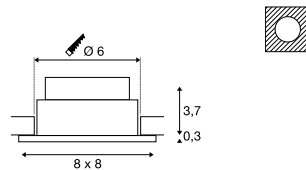

Hinweis

Produkte werden mit Clipfedern geliefert. Blattfedern liegen dem Produkt bei und können ausgetauscht werden. Materialstärke Einbaufäche: 20 m

Ein Anwendungsvideo zu Dim to Warm finden Sie un er <http://bit.ly/dim-to-warm>



Variante	Art. Nr.
440lm 1800-3000K CRI>95 ■ schwarz	1002098
440lm 1800-3000K CRI>95 □ matt weiß	1002099
440lm 1800-3000K CRI>95 ■ matt aluminium	1002100

Variante	Art. Nr.
440lm 1800-3000K CRI95 ■ schwarz	1002101
440lm 1800-3000K CRI95 □ matt weiß	1002102
440lm 1800-3000K CRI95 ■ matt aluminium	1002103

1002099 466

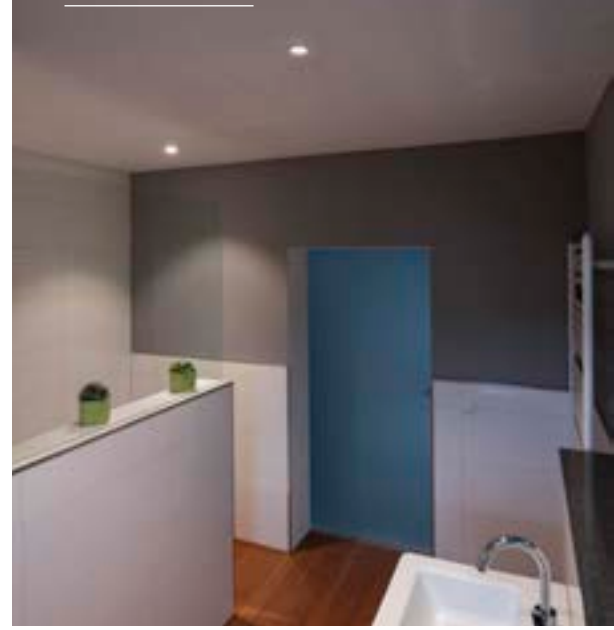

1002101 466

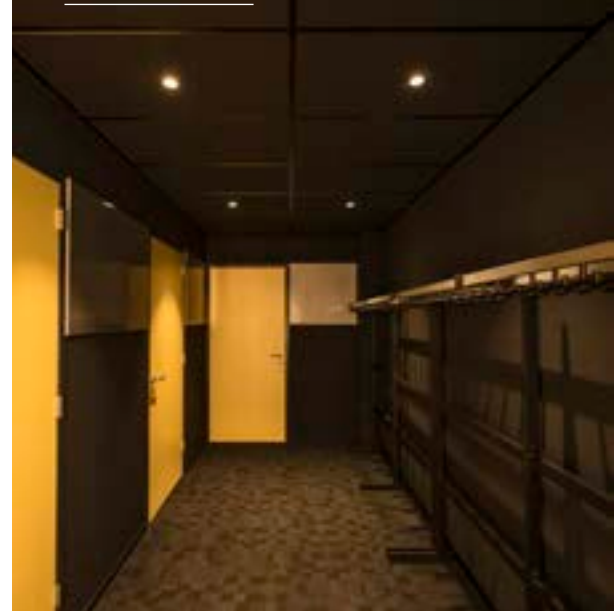

1002101 466

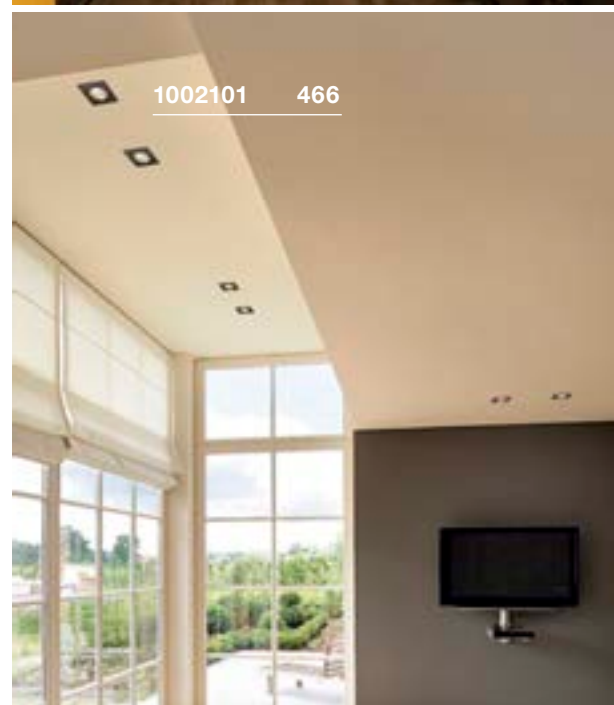



114430 467

PATTA-I
EL, round, TRIAC

A-A++ Spektrum A++-E

LED INSIDE



• Hohe IP-Schutzart (vollflächiges Schutzglas)

Produktangaben

220-240V ~50/60Hz | 500mA
Systemleistung: 11W
Material: Aluminium / Glas
Dimmbar: Triac C, Triac L

IP20/65 0,25 40000 38° 0,2 IK02

Maßzeichnung

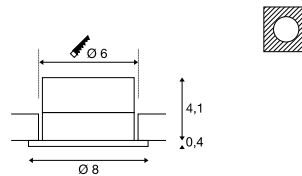

Hinweis

Materialstärke Einbaufäche: 25 m

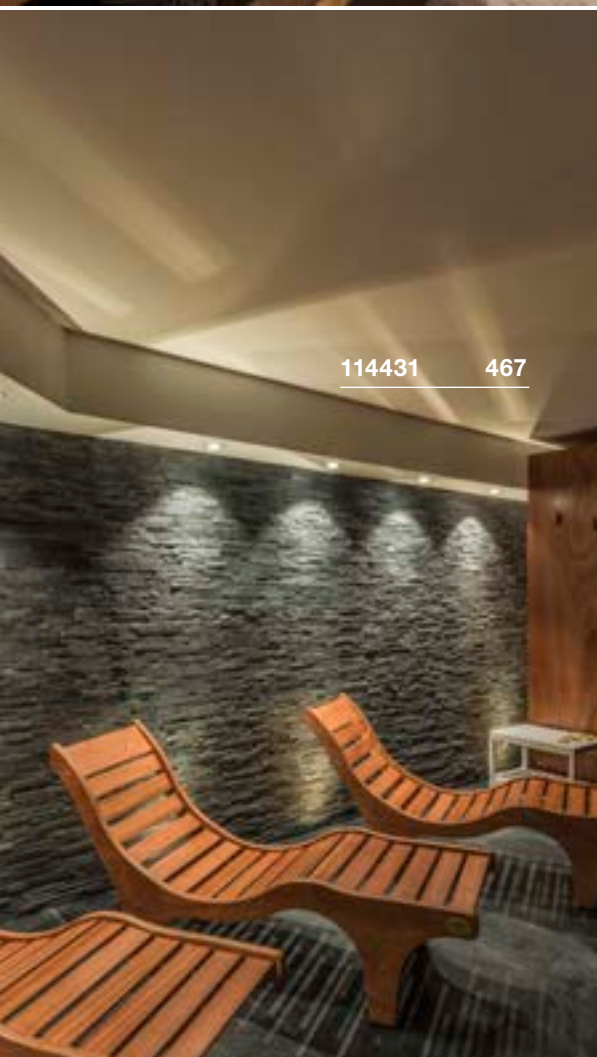

114431 467

PATTA-I
EL, square, TRIAC

A-A++ Spektrum A++-E

LED INSIDE



• Hohe IP-Schutzart (vollflächiges Schutzglas)

Produktangaben

220-240V ~50/60Hz | 500mA
Systemleistung: 11W
Material: Aluminium / Glas
Dimmbar: Triac C, Triac L

IP20/65 0,25 40000 38° 0,2 IK02

Maßzeichnung

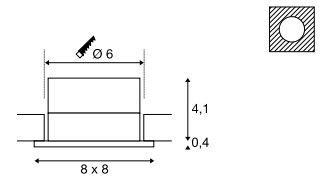

Hinweis

Materialstärke Einbaufäche: 25 m

Variante	Art. Nr.
910lm 3000K CRI>80	
■ matt schwarz	114420
910lm 3000K CRI>80	
□ matt weiß	114421
910lm 3000K CRI>80	
■ matt aluminium	114426

Variante	Art. Nr.
910lm 3000K CRI>80	
■ matt schwarz	114430
910lm 3000K CRI>80	
□ matt weiß	114431
910lm 3000K CRI>80	
■ matt aluminium	114436

117311 469



117331 469

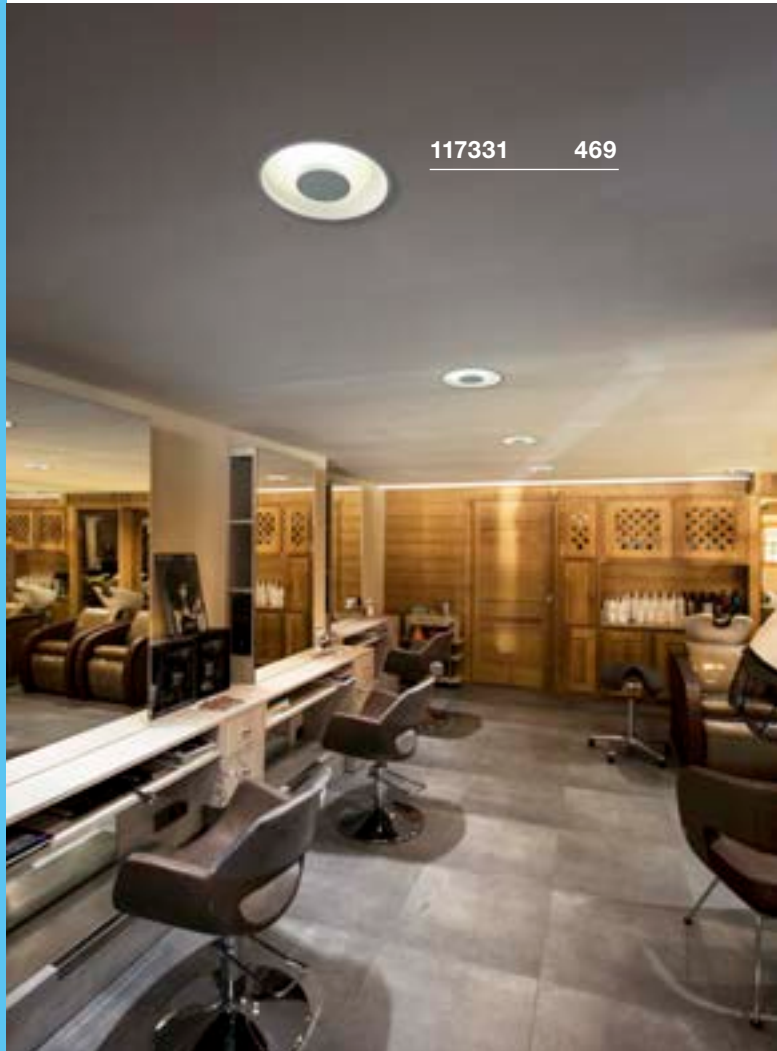

117341 469

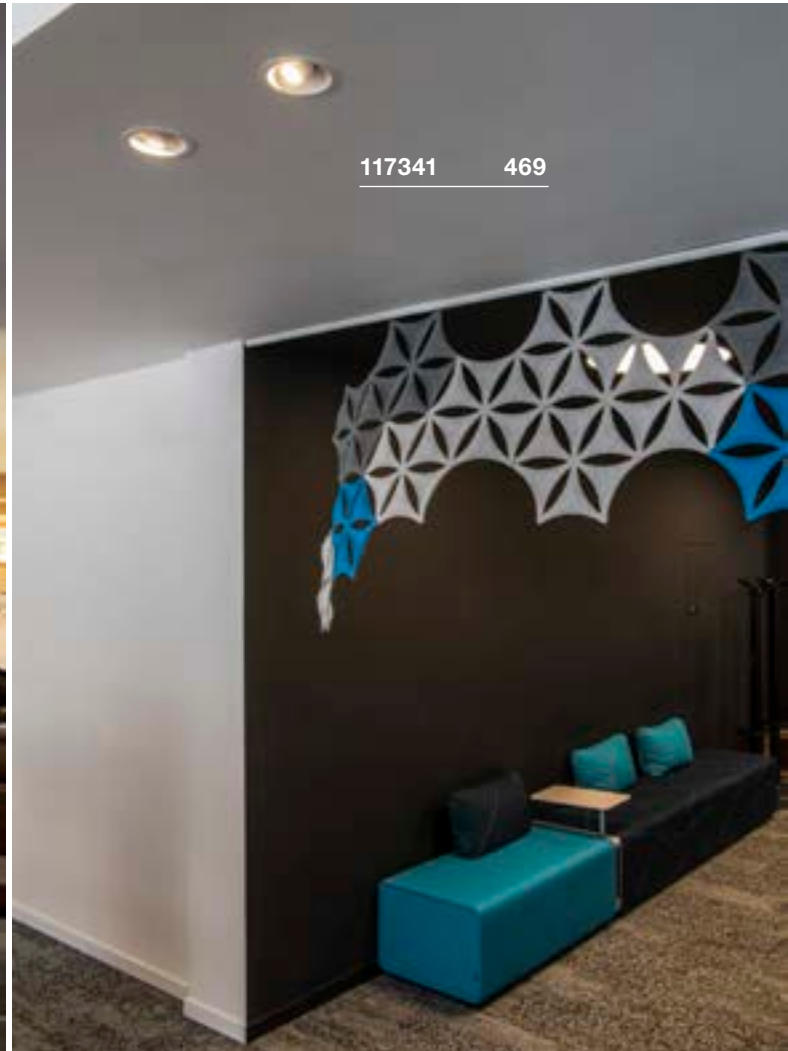

OCCULDAS 23
EL, indirect, TRIAC



A-A++ Spektrum A++-E



- Blendfreies indirektes Licht
- Besonders flacher Rahme und geringe Einbautiefe

Produktangaben

200-240V ~50/60Hz | 700mA
Systemleistung: 26W
Material: Aluminium / Stahl
Dimmbar: Triac C, Triac L

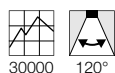
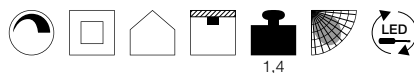

Maßzeichnung

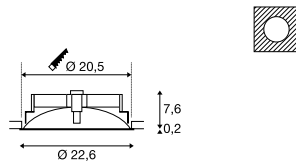

Hinweis

Materialstärke Einbaufäche: 10-30 mm max

Variante	Art. Nr.
1500lm 3000K CRI>80 □ weiß	117311

OCCULDAS 14
EL, indirect, TRIAC



A-A++ Spektrum A++-E



- Blendfreies indirektes Licht
- Besonders flacher Rahme und geringe Einbautiefe

Produktangaben

220-240V ~50/60Hz | 350mA
Systemleistung: 15W
Material: Aluminium / Stahl
Dimmbar: Triac C, Triac L

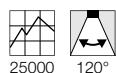
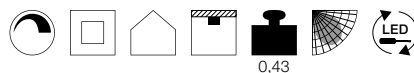

Maßzeichnung

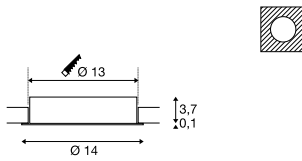

Hinweis

Materialstärke Einbaufäche: 1-20 mm max

Variante	Art. Nr.
810lm 3000K CRI>80 □ weiß	117331

OCCULDAS 14 MOVE
EL, TRIAC



A-A++ Spektrum A++-E



- Einstellbarer Spot
- Besonders flacher Rahme und geringe Einbautiefe

Produktangaben

220-240V ~50/60Hz | 350mA
Systemleistung: 7,8W
Material: Aluminium / Stahl
Dimmbar: Triac C, Triac L

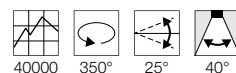
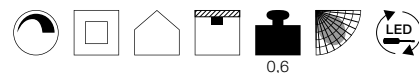

Maßzeichnung

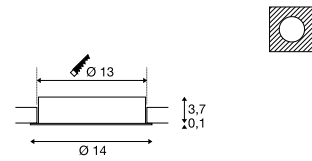

Hinweis

Materialstärke Einbaufäche: 1-20 mm max

Variante	Art. Nr.
700lm 3000K CRI>80 □ weiß	117341

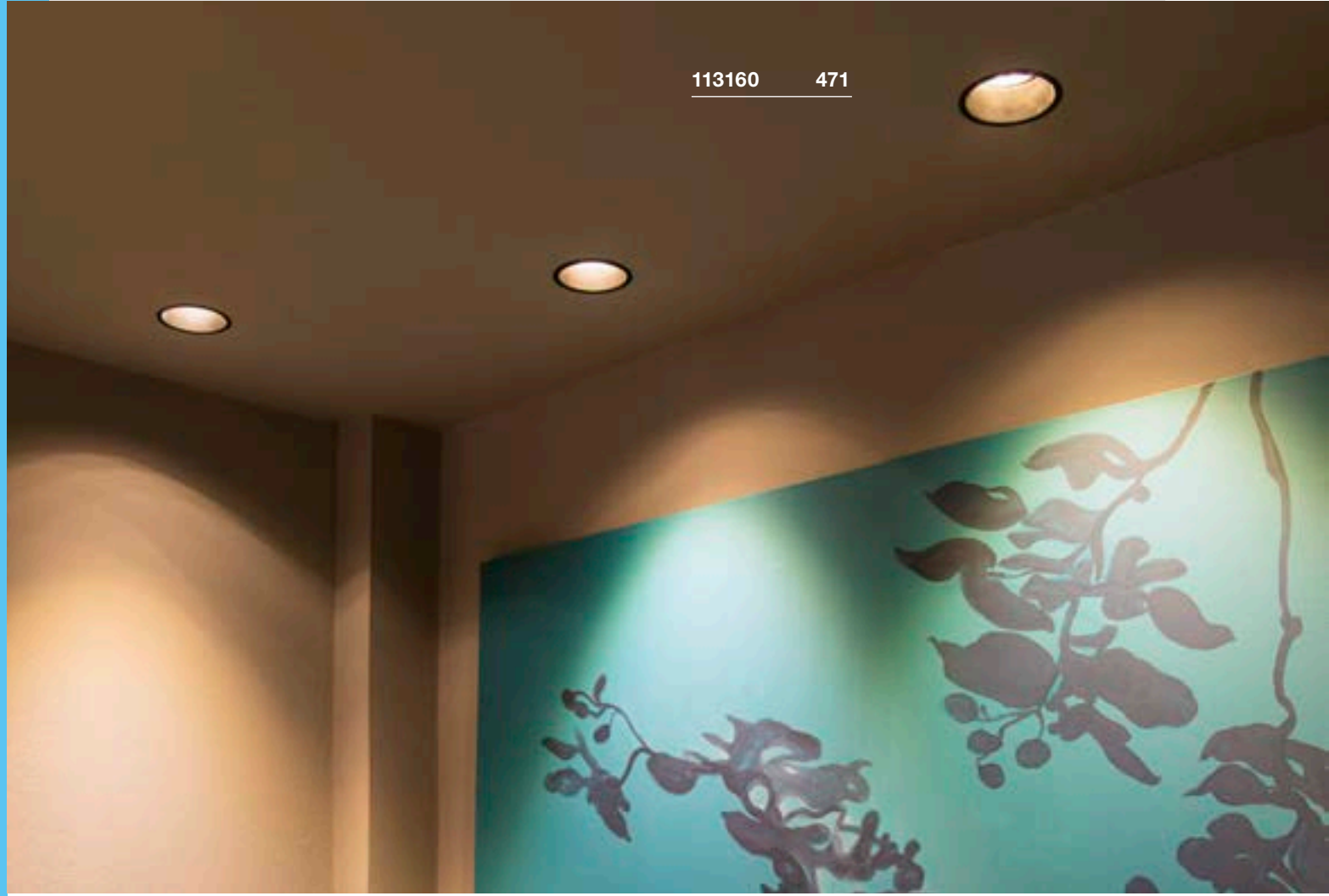

113160 471



113160 471



113151 471

HORN-O
EL, QPAR51

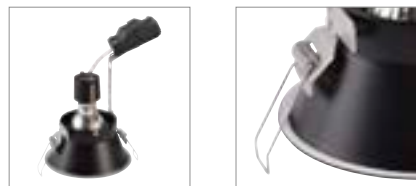
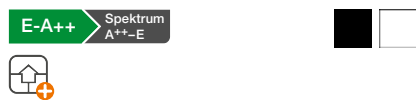

- Schmäler Einbaukragen
- Schutzglas für IP21-Anwendungen

Produktangaben

230V ~50Hz
Material: Stahl

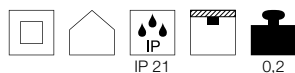

Maßzeichnung

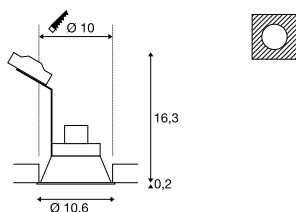

Hinweis

Materialstärke Einbaufäche: 25mm max

Leuchtmittlempfehlung

GU10 5,5W 36°
2800K 420lm EEK=A+
6kWh/1000h
Art. Nr. 1001217



LED GU10 5,5W 38°
2700K 400lm EEK=A+
6kWh/1000h
Art. Nr. 1001030



Leuchtmittelangaben

max. 50W QPAR51

Variante	Art. Nr.
GU10 QPAR51	
■ matt schwarz	113160
GU10 QPAR51	
□ matt weiß	113161

HORN-T
EL, QPAR51

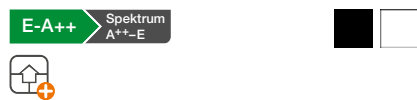

- Schmäler Einbaukragen

Produktangaben

220-240V ~50/60Hz
Material: Stahl

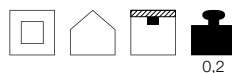

Maßzeichnung

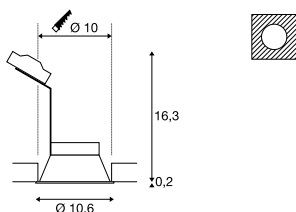

Hinweis

Materialstärke Einbaufäche: 25mm max

Leuchtmittlempfehlung

LED GU10 7,2W 36°
4000K 540lm EEK=A+
8kWh/1000h
Art. Nr. 1001565



LED GU10 7W 25/40/55°
3000K 300lm EEK=A
7kWh/1000h
Art. Nr. 560603



Leuchtmittelangaben

max. 50W QPAR51

Variante	Art. Nr.
GU10 QPAR51	
■ matt schwarz	113140
GU10 QPAR51	
□ matt weiß	113141

HORN-A
EL, QPAR51

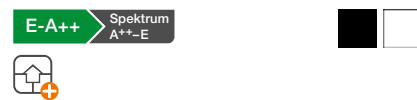

- Asymmetrischer Lichtaustritt
- Schutzglas für IP21 Anwendungen

Produktangaben

230V ~50Hz
Material: Stahl

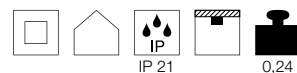

Maßzeichnung

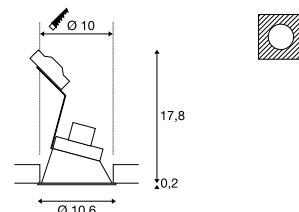

Hinweis

Materialstärke Einbaufäche: 25 mm

Leuchtmittlempfehlung

LED GU10 7,2W 36°
4000K 540lm EEK=A+
8kWh/1000h
Art. Nr. 1001565



LED GU10 7W 25/40/55°
3000K 300lm EEK=A
7kWh/1000h
Art. Nr. 560603



Leuchtmittelangaben

max. 50W QPAR51

Variante	Art. Nr.
GU10 QPAR51	
■ matt schwarz	113150
GU10 QPAR51	
□ matt weiß	113151

HORN-T EL, QPAR11

E-A++ Spektrum
A++-E



- Schmäler Einbaukragen

Produktangaben

230V ~50Hz
Material: Stahl

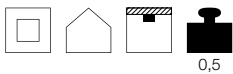

Maßzeichnung

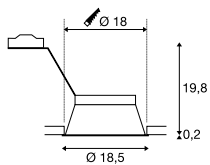

Hinweis

Materialstärke Einbaufläche: 30 mm max

Leuchtmittlempfehlung

GU10 7,3W 13°
2700K 660lm EEK=A+
8kWh/1000h
Art. Nr. 1000939



LED GU10 7,9W 40°
4000K 760lm EEK=A+
8kWh/1000h
Art. Nr. 560724



Leuchtmittelangaben

max. 75W QPAR111

Variante	Art. Nr.
GU10 QPAR111	
■ matt schwarz	113170
GU10 QPAR111	
□ matt weiß	113171

113170 472

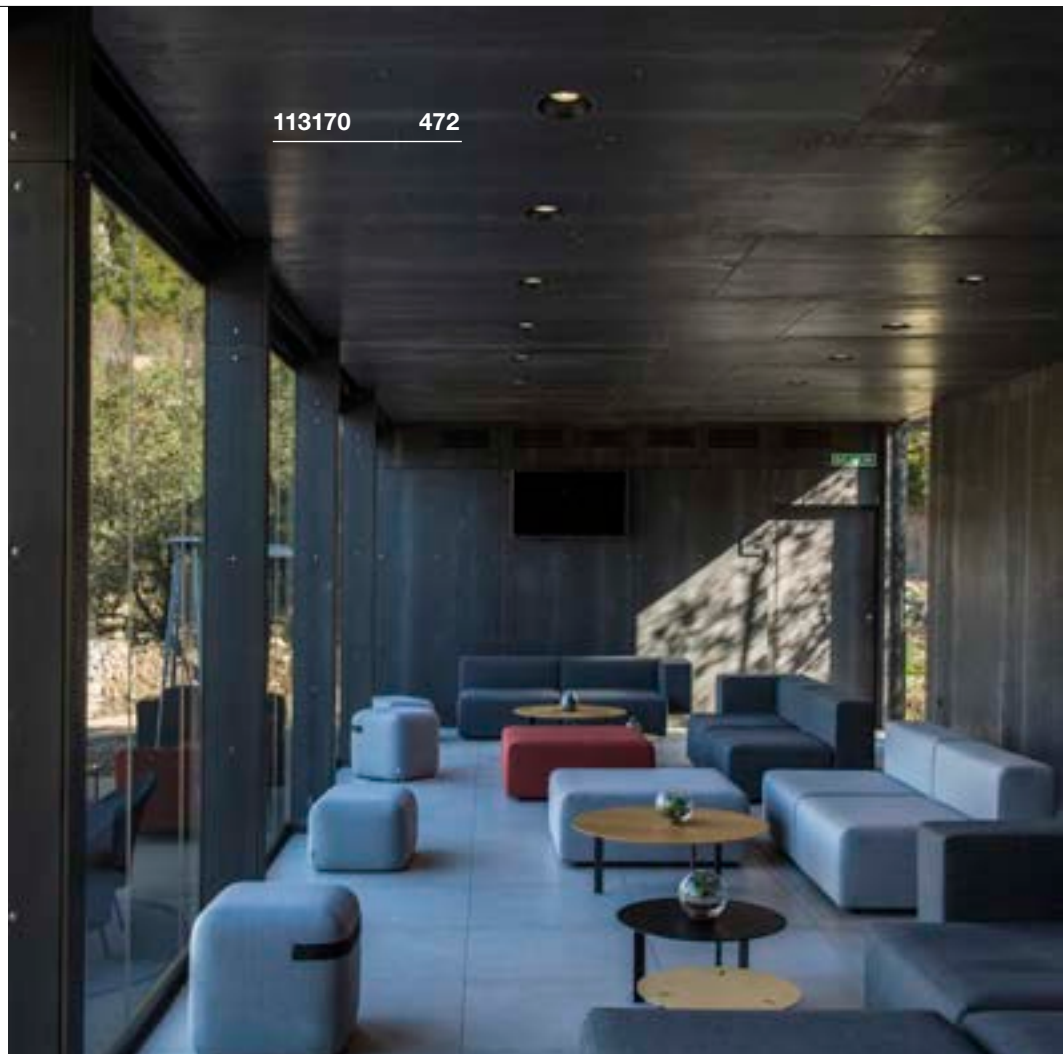

113171 472

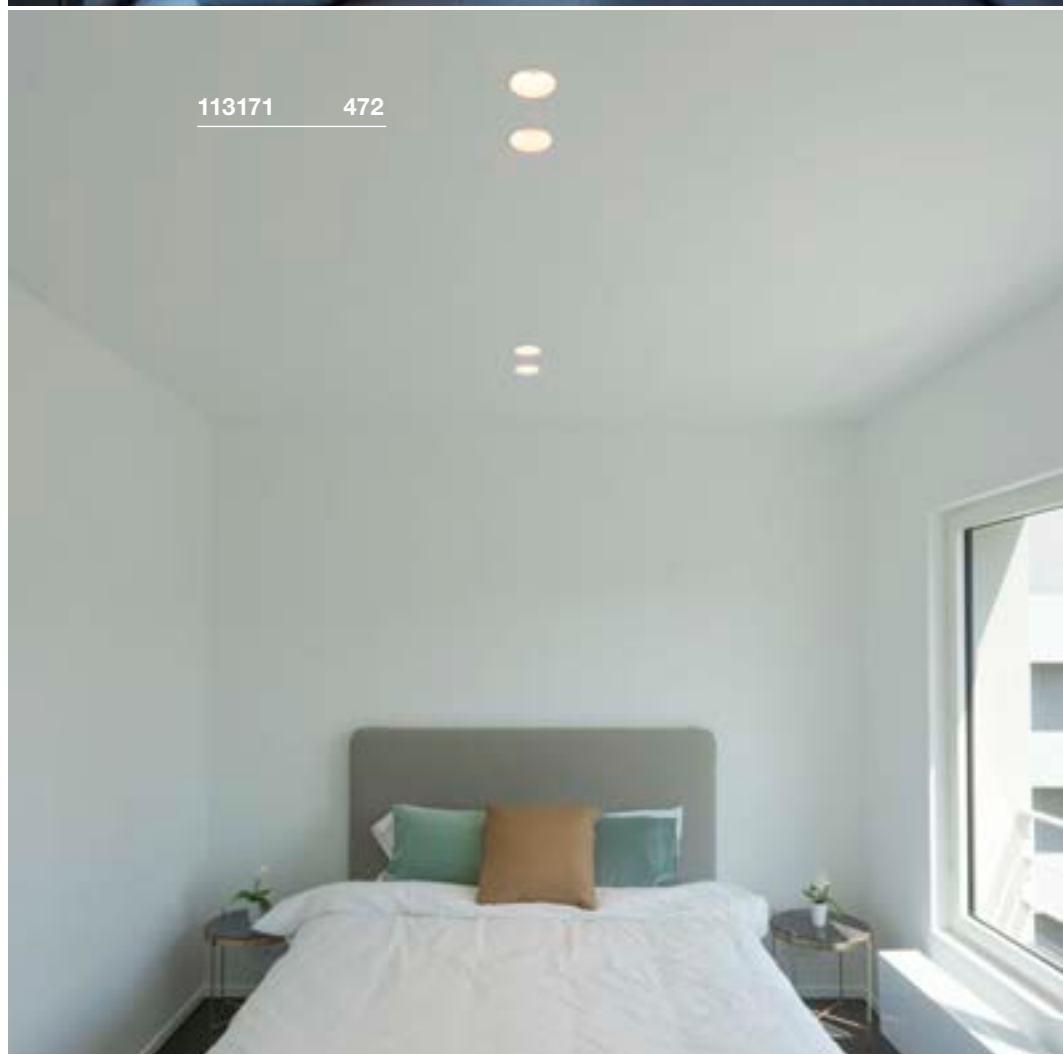



113110 473



113110 473



112910 473

HORN
EL, QPAR51

E-A++ Spektrum A++-E



• Schmäler Einbaukragen

Produktangaben

230V ~50Hz
Material: Stahl

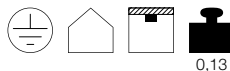

Maßzeichnung

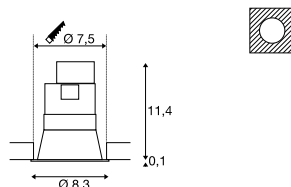

Hinweis

Materialstärke Einbaufäche: 45 mm ma

HORN
EL, QPAR51

E-A++ Spektrum A++-E



• Schmäler Einbaukragen

Produktangaben

230V ~50Hz
Material: Aluminium / Stahl

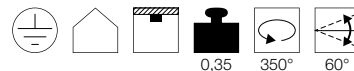

Maßzeichnung

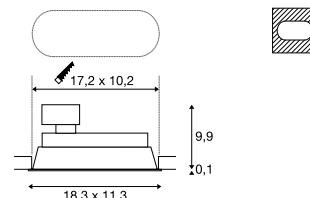

Hinweis

Materialstärke Einbaufäche: 45 mm ma

Leuchtmittlempfehlung

GU10 5,5W 36°
2800K 420lm EEK=A+
6kWh/1000h
Art. Nr. 1001217



LED GU10 5,5W 38°
2700K 400lm EEK=A+
6kWh/1000h
Art. Nr. 1001030



Leuchtmittelangaben

max. 50W QPAR51

Variante	Art. Nr.
GU10 QPAR51	
■ matt schwarz	112910
GU10 QPAR51	
□ matt weiß	112911

Leuchtmittlempfehlung

LED GU10 5,5W 38°
2700K 400lm EEK=A+
6kWh/1000h
Art. Nr. 1001030



LED GU10 7,2W 36°
2700K 570lm EEK=A+
8kWh/1000h
Art. Nr. 560542



Leuchtmittelangaben

2x max. 50W QPAR51

Variante	Art. Nr.
GU10 QPAR51	
■ matt schwarz	113110
GU10 QPAR51	
□ matt weiß	113111

HORN MINI EL

A-A++ Spektrum A++-E

LED INSIDE



• Premium LED mit CRI>90

HORN MEDI EL

A-A++ Spektrum A+++-E

LED INSIDE



Produktangaben

Produktangaben

350mA | 1,2W
Material: Aluminium / Polycarbonat (PC)

350mA | 5W
Material: Aluminium / Polycarbonat (PC)

Maßzeichnung

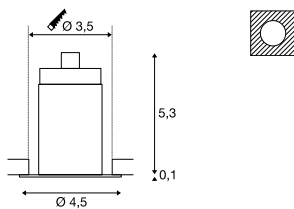

Maßzeichnung

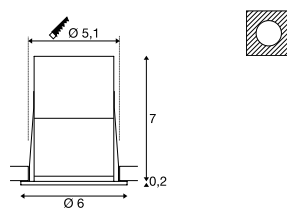

Hinweis

Treiber exkl.
AMP Stecker inkl.
Bei goldenem Reflek or abweichende Lichtfarbe

Hinweis

Bei goldenem Reflek or abweichende Lichtfarbe
Offenes Kabelend

Zubehörempfehlung

- LED Treiber 350mA | 3W
Art. Nr. 464107
- Steckerleiste 3 Ausgänge
Art. Nr. 111850

Zubehörempfehlung

- LED Treiber 350mA | 10W
Art. Nr. 464140

Variante	Art. Nr.
70lm 3000K CRI>90 <input type="checkbox"/> weiß	1000914
70lm 3000K CRI>90 <input checked="" type="checkbox"/> schwarz	1000915
70lm 3000K CRI>90 <input checked="" type="checkbox"/> weiß / schwarz	1000916
70lm 3000K CRI>90 <input checked="" type="checkbox"/> schwarz / gold	1000917

Variante	Art. Nr.
350lm 3000K CRI>80 <input type="checkbox"/> weiß	1001924
230lm 3000K CRI>80 <input checked="" type="checkbox"/> schwarz	1001925
230lm 3000K CRI>80 <input checked="" type="checkbox"/> weiß / schwarz	1001926
275lm 3000K CRI>80 <input checked="" type="checkbox"/> schwarz	1001927

HORN MAGNA EL

A-A++ Spektrum A++-E

LED INSIDE

NEW VARIANT

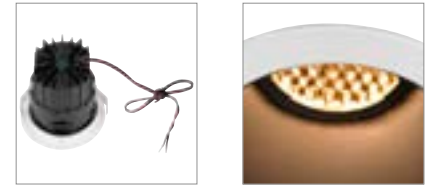

Produktangaben

500mA | 7,7W
Material: Aluminium / Polycarbonat (PC)

Maßzeichnung

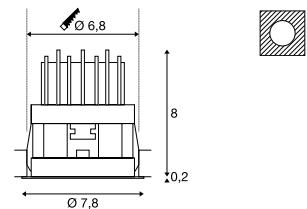

Hinweis

Treiber exkl.
Bei goldenem Reflek or abweichende Lichtfarbe
Offenes Kabelend

Zubehörempfehlung

- Blendschutz
Art. Nr. 1002596
- LED Treiber 500mA | 9W
Art. Nr. 464091

Variante	Art. Nr.
470lm 3000K CRI>80 <input type="checkbox"/> weiß	1002591
415lm 3000K CRI>80 <input checked="" type="checkbox"/> schwarz	1002592
415lm 3000K CRI>80 <input checked="" type="checkbox"/> weiß / schwarz	1002593
400lm 3000K CRI>80 <input checked="" type="checkbox"/> schwarz / gold	1002594

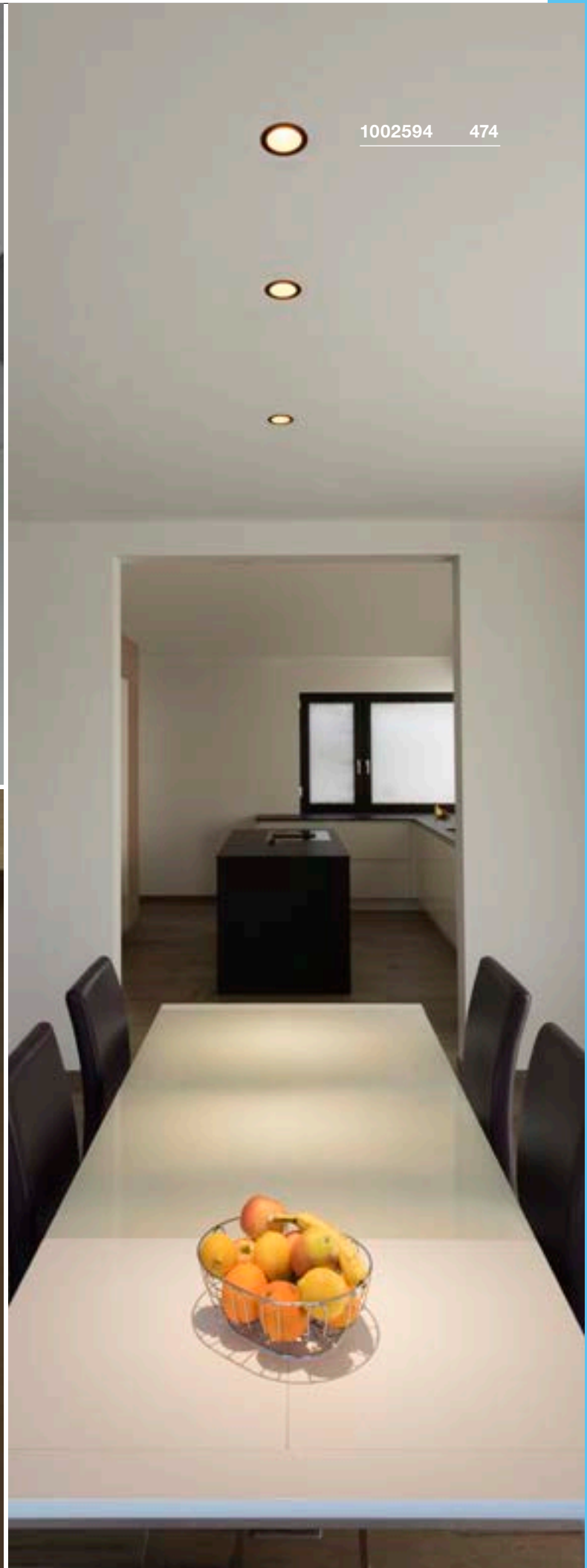

RENISTO
EL, square, Gehäuse, TRIAC

A-A++ Spektrum A++-E

- Homogenes Design
- Produkte der Familie vielfältig kombinierbar
- Reflek or individuell wählbar über Zubehör

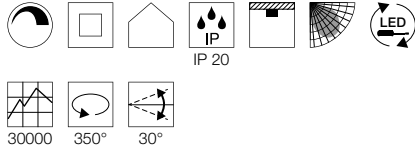

Hinweis

Materialstärke Einbaufäche: 30 m
Passende Abdeckung wird benötigt, siehe Zubehörepfehlung



RENISTO S
EL, square, Gehäuse, TRIAC



Produktangaben

220-240V ~50/60Hz | 500mA
Systemleistung: 9,6W
Material: Aluminium
Dimmbar: Triac C, Triac L

Maßzeichnung

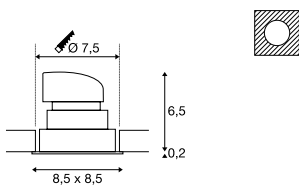

Zubehörepfehlung

Weiße Abdeckung

Art. Nr. 1001831

Silberne Abdeckung

Art. Nr. 1001832



Variante	Art. Nr.
500lm 3000K CRI>80 0,206 kg 36° <input type="checkbox"/> weiß	1001828

RENISTO M
EL, square, Gehäuse, TRIAC



Produktangaben

220-240V ~50/60Hz | 350mA
Systemleistung: 16W
Material: Aluminium
Dimmbar: Triac C

Maßzeichnung

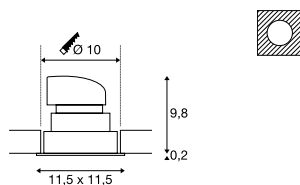

Zubehörepfehlung

Weiße Abdeckung

Art. Nr. 1001833

Silberne Abdeckung

Art. Nr. 1001834



Variante	Art. Nr.
900lm 3000K CRI>80 0,408 kg 36° <input type="checkbox"/> weiß	1001829

RENISTO L
EL, square, Gehäuse, TRIAC



Produktangaben

220-240V ~50/60Hz | 700mA
Systemleistung: 29W
Material: Aluminium
Dimmbar: Triac C, Triac L

Maßzeichnung

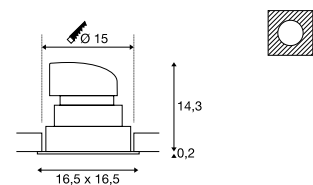

Zubehörepfehlung

Weiße Abdeckung

Art. Nr. 1001835

Silberne Abdeckung

Art. Nr. 1001836



Variante	Art. Nr.
2500lm 3000K CRI>80 0,991 kg 40° <input type="checkbox"/> weiß	1001830



RENISTO EL, round, Gehäuse, TRIAC

A-A++ Spektrum
A++-E

- Homogenes Design
- Produkte der Familie vielfältig kombinierbar
- Reflek or individuell wählbar über Zubehör

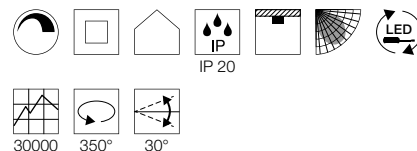

Hinweis

Materialstärke Einbaufäche: 30 m
Passende Abdeckung wird benötigt,
siehe Zubehörepfehlung

RENISTO S EL, round, Gehäuse, TRIAC



Produktangaben

220-240V ~50/60Hz | 500mA
Systemleistung: 9,6W
Material: Aluminium
Dimmbar: Triac C, Triac L

Maßzeichnung

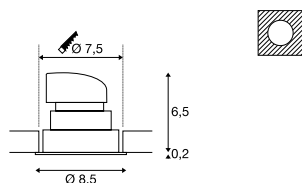

Zubehörepfehlung

- Weiße Abdeckung
Art. Nr. 1001849
- Silberne Abdeckung
Art. Nr. 1001850

Variante	Art. Nr.
500lm 3000K CRI>80 0,206 kg 36° <input type="checkbox"/> weiß	1001847

RENISTO M EL, round, Gehäuse, TRIAC



Produktangaben

220-240V ~50/60Hz | 350mA
Systemleistung: 16W
Material: Aluminium
Dimmbar: Triac C, Triac L

Maßzeichnung

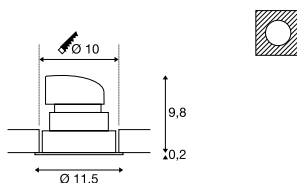

Zubehörepfehlung

- Weiße Abdeckung
Art. Nr. 1001851
- Silberne Abdeckung
Art. Nr. 1001825

Variante	Art. Nr.
900lm 3000K CRI>80 0,408 kg 36° <input type="checkbox"/> weiß	1001841

RENISTO L EL, round, Gehäuse, TRIAC



Produktangaben

220-240V ~50/60Hz | 700mA
Systemleistung: 29W
Material: Aluminium
Dimmbar: Triac C

Maßzeichnung

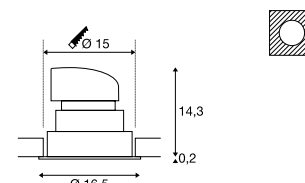

Zubehörepfehlung

- Weiße Abdeckung
Art. Nr. 1001826
- Silberne Abdeckung
Art. Nr. 1001827

Variante	Art. Nr.
2500lm 3000K CRI>80 0,991 kg 40° <input type="checkbox"/> weiß	1001848

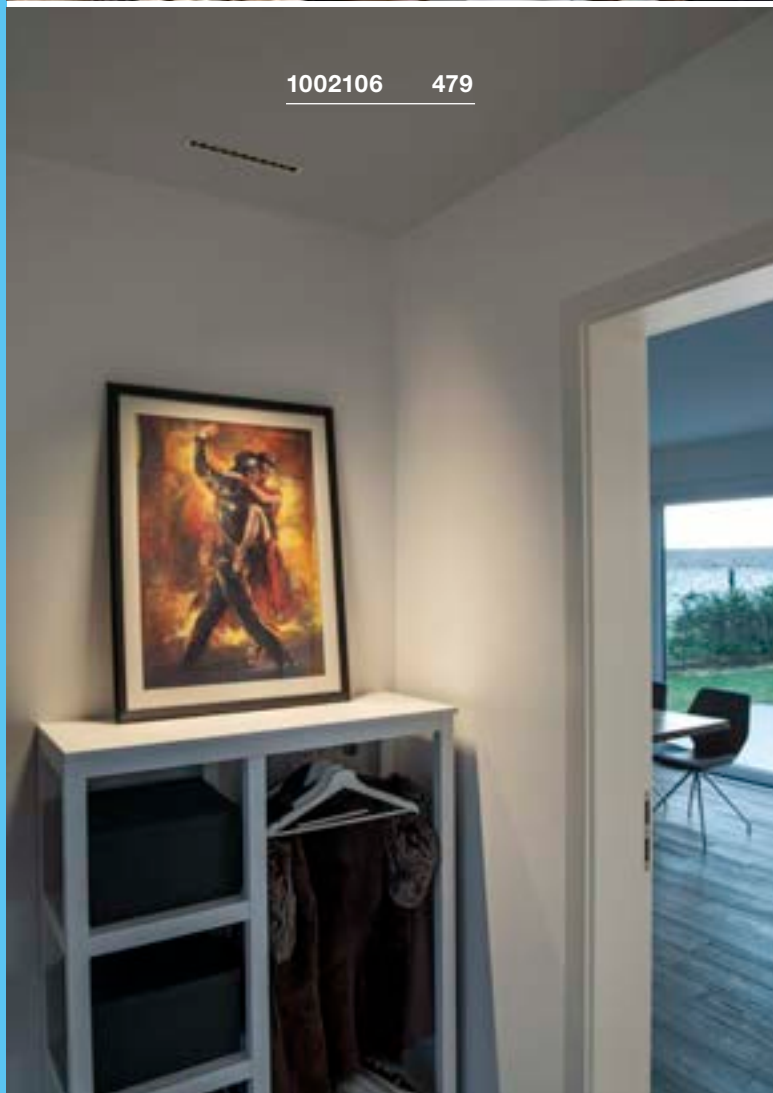
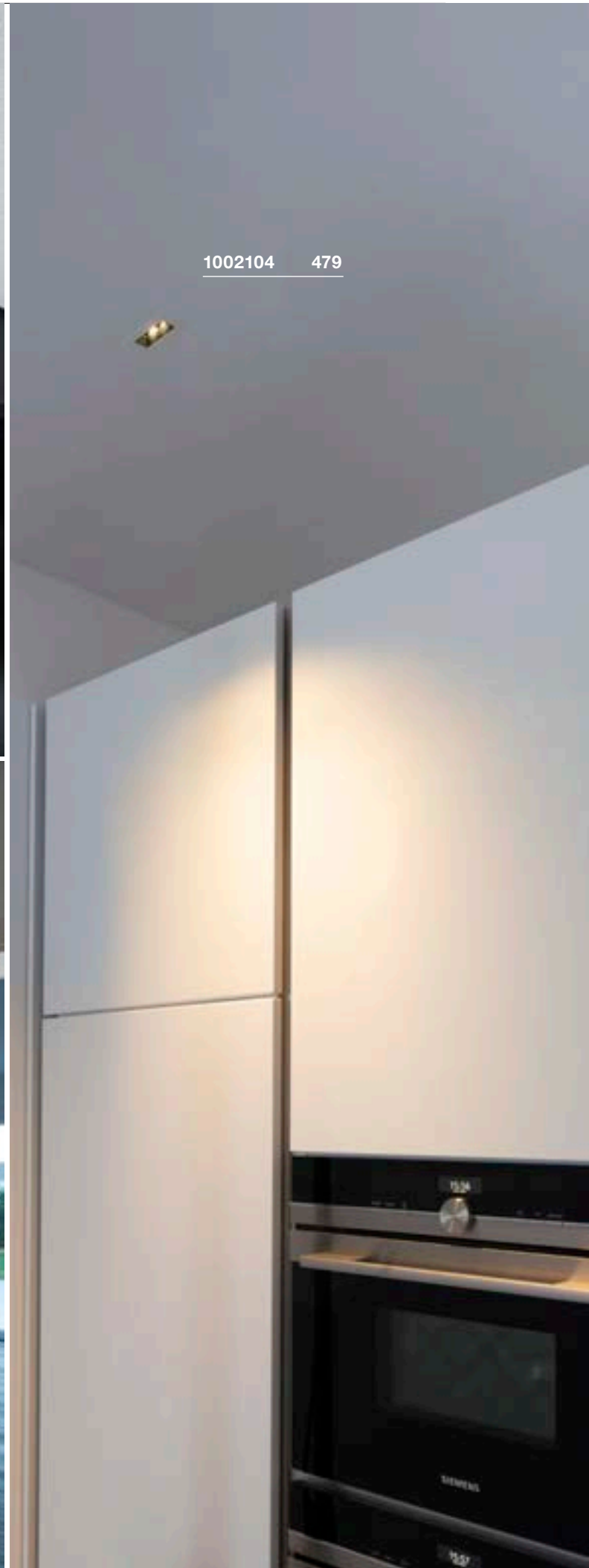



MILANDO 2 EL

A-A++ Spektrum A++-E

LED INSIDE



MILANDO 5 EL

A-A++ Spektrum A++-E

LED INSIDE



MILANDO 10 EL

A-A++ Spektrum A++-E

LED INSIDE



Produktangaben

700mA | 4,3W
Material: Stahl / Polycarbonat (PC)

0,19 19 64

LED 36000 45°

Maßzeichnung

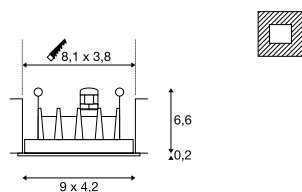

Hinweis

Offenes Kabelend
Materialstärke Einbaufäche: 40 mm

Produktangaben

700mA | 10,7W
Material: Stahl / Polycarbonat (PC)

0,37 19 64

LED 36000 45°

Maßzeichnung

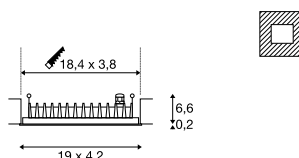

Hinweis

Offenes Kabelend
Materialstärke Einbaufäche: 40 mm

Produktangaben

700mA | 21,4W
Material: Stahl / Polycarbonat (PC)

0,58 19 64

LED 36000 45°

Maßzeichnung

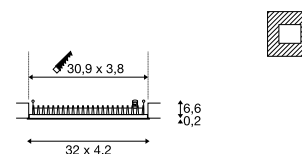

Hinweis

Offenes Kabelend
Materialstärke Einbaufäche: 40 mm

Zubehörempfehlung

LED Treiber 700mA | 11W inkl. Zugentlastung
Art. Nr. 464030



Variante	Art. Nr.
280lm 3000K CRI>80	
■ schwarz	1002107
280lm 3000K CRI>80	
■ schwarz/weiß	1002104

Zubehörempfehlung

LED Treiber 700mA | 11W inkl. Zugentlastung
Art. Nr. 464030



Variante	Art. Nr.
640lm 3000K CRI>80	
■ schwarz	1002108
640lm 3000K CRI>80	
■ schwarz/weiß	1002105









Zubehörempfehlung

TRIAC LED Treiber 700mA | 40W
Art. Nr. 1001267



Variante	Art. Nr.
1240lm 3000K CRI>80	
■ schwarz	1002109
1240lm 3000K CRI>80	
■ schwarz/weiß	1002106

NEW TRIA LEUCHTENSERIE. EINBAULEUCHTEN.

Konventionelle NEW TRIA	NEW TRIA 68	NEW TRIA 78 XL	NEW TRIA 78	NEW TRIA 78	
Beispiel					
Form					
Leuchtmittel	QPAR51	QPAR51	QPAR51	QPAR51	
Lumen	-	-	-	-	
Color	-	-	-	-	
Dimmbar	-	-	-	-	
Variante	Clipfedern/Blattfedern	Clipfedern	Blattfedern	Clipfedern	
IP	-	-	-	-	

LED NEW TRIA	NEW TRIA 45	NEW TRIA 68	NEW TRIA 68	NEW TRIA 68	
Beispiel					
Form					
Leuchtmittel					
Lumen	143lm	300lm	800lm-890lm	440lm	
Color	3000K	2700K/3000K	2700K/3000K	1800K-3000K	
Dimmbar	-	-	Triac C, Triac L	Triac C, Triac L	
Variante	Clipfedern	Clipfedern	Clipfedern	Clipfedern/Blattfedern	
IP	IP 44	-	-	-	



	NEW TRIA 155	NEW TRIA 150	NEW TRIA 300
			
			
	QPAR51	QPAR111	QPAR111
	-	-	-
	-	-	-
	Clipfedern	Blattfedern	Clipfedern
	-	-	-

	NEW TRIA 77	NEW TRIA 155	NEW TRIA 110	NEW TRIA 150
				
				
	LED INSIDE	LED INSIDE	LED INSIDE	LED INSIDE
	645lm-700lm	1160lm-1250lm	1010lm-1120lm	2210lm-2500lm
	2700K/3000K	2700K/3000K	2700K/3000K	2700K/3000K
	-	-	Triac C, Triac L	1-10V
	Clipfedern	Clipfedern	Clipfedern	Clipfedern
	-	-	-	-

NEW TRIA 68
Single, round, CS/LS, QPAR51

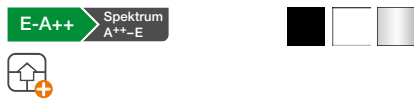

NEW TRIA 68
Single, square, CS/LS, QPAR51

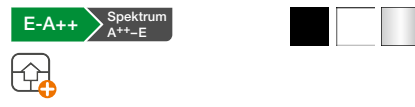

Produktangaben

230V ~50Hz
Material: Aluminium

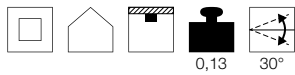

0,13 30°

Maßzeichnung

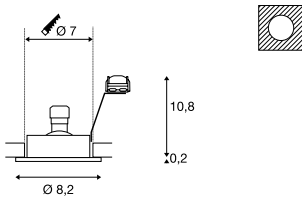

Produktangaben

230V ~50Hz
Material: Aluminium

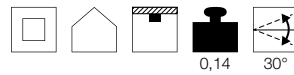

0,14 30°

Maßzeichnung

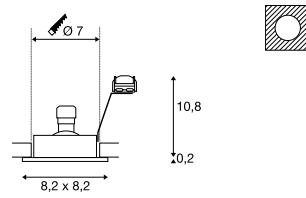

Hinweis

Produkte werden mit Clipfedern geliefert. Blattfedern liegen dem Produkt bei und können ausgetauscht werden. Materialstärke Einbaulfläche: 20 m

Hinweis

Produkte werden mit Clipfedern geliefert. Blattfedern liegen dem Produkt bei und können ausgetauscht werden. Materialstärke Einbaulfläche: 20 m

Leuchtmittlempfehlung

GU10 5,5W 36°
2800K 420lm EEK=A+
6kWh/1000h
Art. Nr. 1001217



LED GU10 5,1W 48°
2700-6500K 350lm EEK=A+
6kWh/1000h
Art. Nr. 1001918



Leuchtmittlempfehlung

LED GU10 5,5W 38°
2700K 400lm EEK=A+
6kWh/1000h
Art. Nr. 1001030



LED GU10 7,2W 36°
2700K 570lm EEK=A+
8kWh/1000h
Art. Nr. 560542



Leuchtmittelangaben

max. 50W QPAR51

Variante	Art. Nr.
GU10 QPAR51	
■ schwarz	1001980
□ weiß	1001981
■ matt aluminium	1001982

Leuchtmittelangaben

max. 50W QPAR51

Variante	Art. Nr.
GU10 QPAR51	
■ schwarz	1001994
□ weiß	1001995
■ matt aluminium	1001996

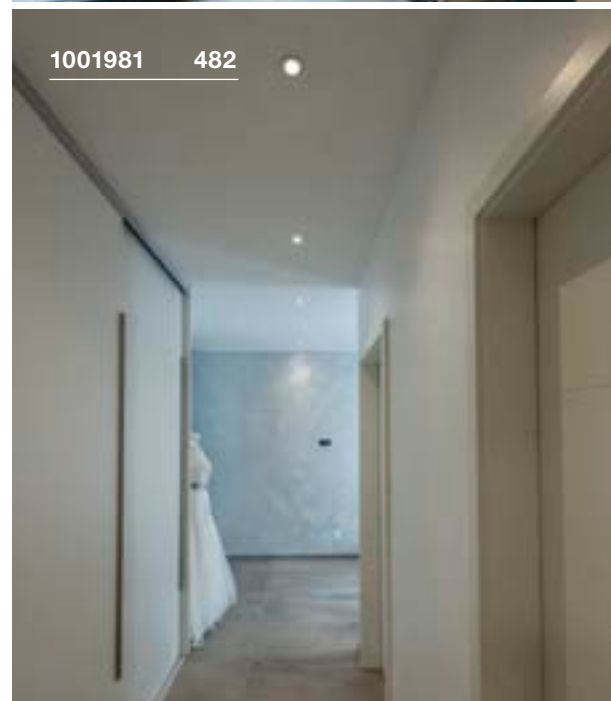
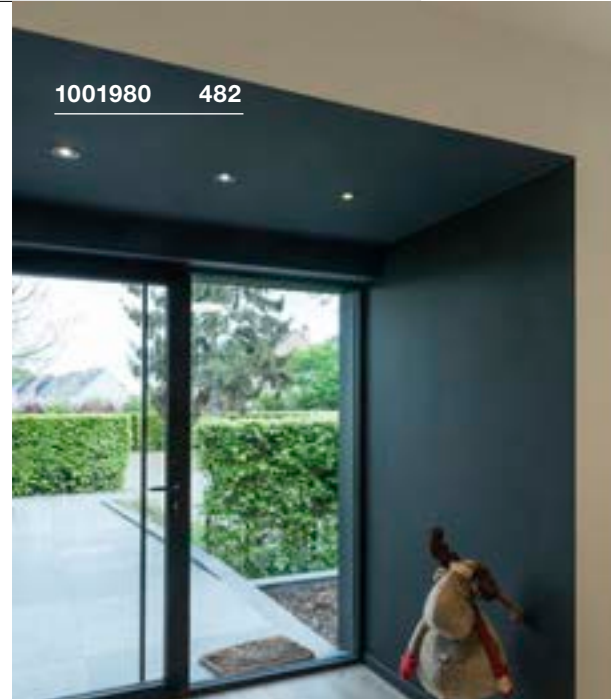



113456 483



113456 483

NEW TRIA 78 XL
Single, round, CS, QPAR51

E-A++ Spektrum A++-E



- Breiter Rand

Produktangaben

230V ~50Hz
Material: Aluminium

0,19 360° 30°

Maßzeichnung

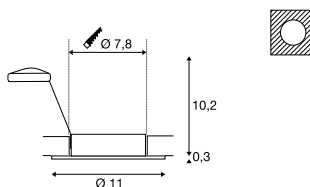

Hinweis

Materialstärke Einbaufäche: 18 mm

Leuchtmittlempfehlung

GU10 5,5W 36°
2800K 420lm EEK=A+
6kWh/1000h
Art. Nr. 1001217

LED GU10 7,2W 36°
3000K 520lm EEK=A+
8kWh/1000h
Art. Nr. 1001561



Leuchtmittelangaben

max. 50W QPAR51

Variante	Art. Nr.
GU10 QPAR51	
■ matt schwarz	113440
GU10 QPAR51	
□ matt weiß	113441
GU10 QPAR51	
■ matt aluminium	113446

NEW TRIA 78 XL
Single, square, CS, QPAR51

E-A++ Spektrum A++-E



- Breiter Rand

Produktangaben

230V ~50Hz
Material: Aluminium

0,21 360° 30°

Maßzeichnung

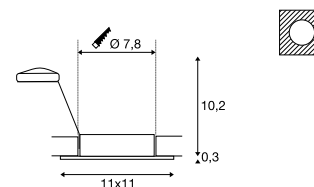

Hinweis

Materialstärke Einbaufäche: 18 mm

Leuchtmittlempfehlung

LED GU10 5,5W 38°
2700K 400lm EEK=A+
6kWh/1000h
Art. Nr. 1001030

LED GU10 7,2W 36°
2700K 570lm EEK=A+
8kWh/1000h
Art. Nr. 560542



Leuchtmittelangaben

max. 50W QPAR51

Variante	Art. Nr.
GU10 QPAR51	
■ matt schwarz	113450
GU10 QPAR51	
□ matt weiß	113451
GU10 QPAR51	
■ matt aluminium	113456

NEW TRIA 78
Single, round, LS, QPAR51

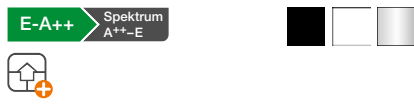

NEW TRIA 78
Single, square, LS, QPAR51

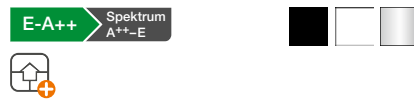

Produktangaben

220-240V ~50/60Hz
Material: Aluminium

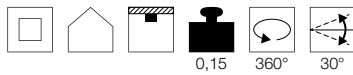

Maßzeichnung

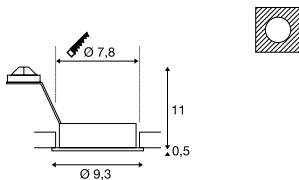

Hinweis

Blattfedern
Materialstärke Einbaufäche: 20 mm max

Leuchtmittlempfehlung

GU10 5,5W 36°
2800K 420lm EEK=A+
6kWh/1000h
Art. Nr. 1001217



LED GU10 5,1W 48°
2700-6500K 350lm EEK=A+
6kWh/1000h
Art. Nr. 1001918



Leuchtmittelangaben

max. 50W QPAR51

Variante	Art. Nr.
GU10 QPAR51 ■ matt schwarz	111710
GU10 QPAR51 □ matt weiß	111711
GU10 QPAR51 ▒ matt aluminium	111716

Produktangaben

220-240V ~50/60Hz
Material: Aluminium

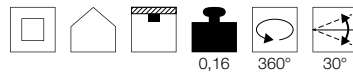

Maßzeichnung

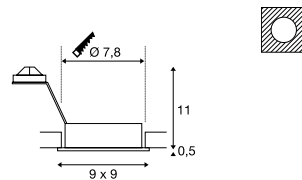

Hinweis

Blattfedern
Materialstärke Einbaufäche: 20 mm max

Leuchtmittlempfehlung

LED GU10 5,5W 38°
2700K 400lm EEK=A+
6kWh/1000h
Art. Nr. 1001030



LED GU10 7,2W 36°
2700K 570lm EEK=A+
8kWh/1000h
Art. Nr. 560542



Leuchtmittelangaben

max. 50W QPAR51

Variante	Art. Nr.
GU10 QPAR51 ■ matt schwarz	111720
GU10 QPAR51 □ matt weiß	111721
GU10 QPAR51 ▒ matt aluminium	111726

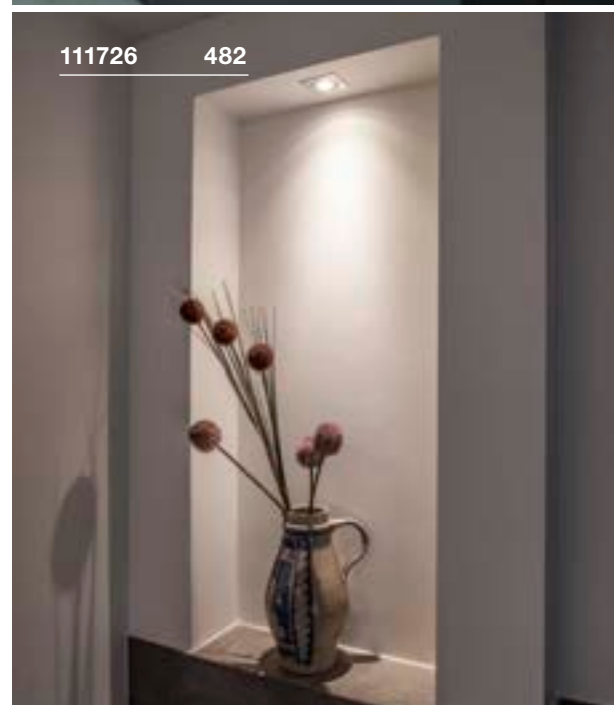
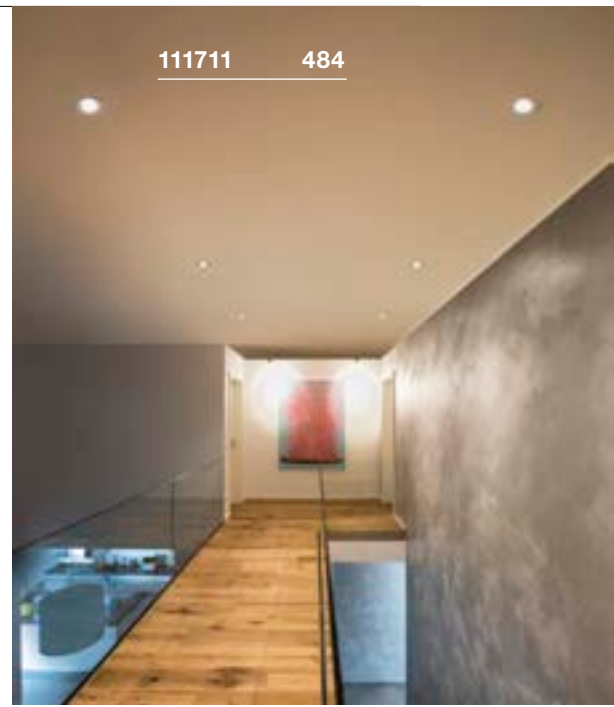



113510 485



113510 485

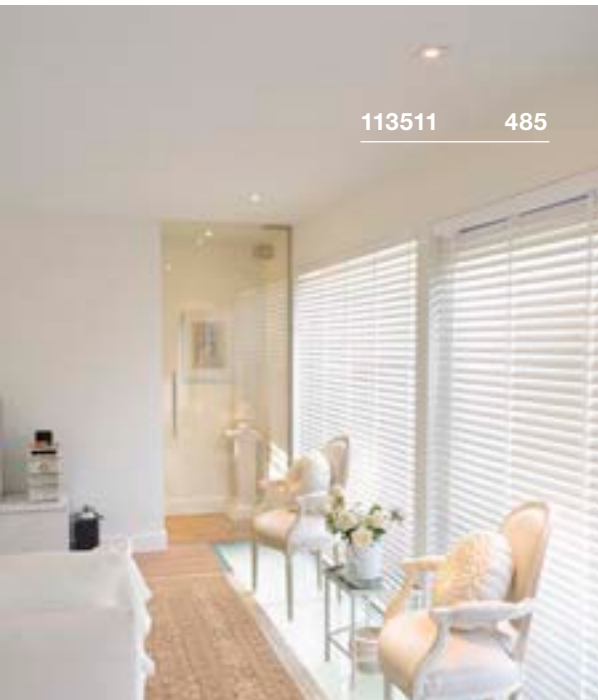

113511 485

NEW TRIA 78
Single, round, CS, QPAR51

E-A++ Spektrum A++-E



NEW TRIA 78
Single, square, CS, QPAR51

E-A++ Spektrum A++-E



Produktangaben

220-240V ~50/60Hz
Material: Aluminium

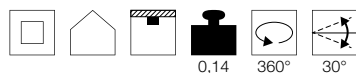

Maßzeichnung

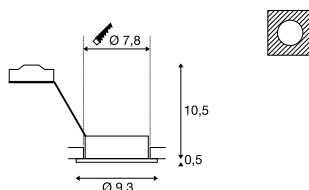

Hinweis

Clipfedern
Materialstärke Einbaufäche: 18 mm max

Produktangaben

220-240V ~50/60Hz
Material: Aluminium

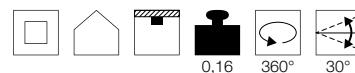

Maßzeichnung

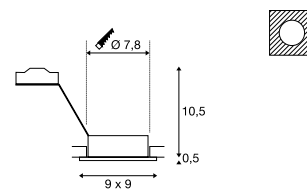

Hinweis

Clipfedern
Materialstärke Einbaufäche: 18 mm max

Leuchtmittlempfehlung

LED GU10 7,2W 36°
4000K 540lm EEK=A+
8kWh/1000h
Art. Nr. 1001565



LED GU10 7W 25/40/55°
3000K 300lm EEK=A
7kWh/1000h
Art. Nr. 560603



Leuchtmittelangaben

max. 50W QPAR51

Variante	Art. Nr.
GU10 QPAR51	
■ schwarz	113490
□ weiß	113510
■ matt aluminium	111360

Leuchtmittlempfehlung

GU10 5,5W 36°
2800K 420lm EEK=A+
6kWh/1000h
Art. Nr. 1001217



LED GU10 5,5W 38°
2700K 400lm EEK=A+
6kWh/1000h
Art. Nr. 1001030



Leuchtmittelangaben

max. 50W QPAR51

Variante	Art. Nr.
GU10 QPAR51	
■ schwarz	113491
□ weiß	113511
■ matt aluminium	111361

NEW TRIA 155

Double, CS, QPAR51

E-A++ Spektrum
A++-E



Produktangaben

220-240V ~50/60Hz
Material: Aluminium

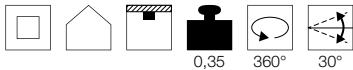

Maßzeichnung

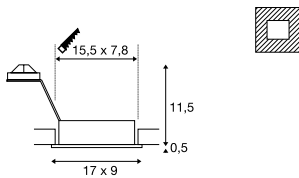

Hinweis

Clipfedern
Materialstärke Einbaufäche: 30 mm ma

Leuchtmittlempfehlung

GU10 5,1W 48°
2700-6500K 350lm EEK=A+
6kWh/1000h
Art. Nr. 1001918



LED GU10 5,6W 60°
2200-6700K 350lm EEK=A+
6kWh/1000h
Art. Nr. 1001919



Leuchtmittelangaben

2x max. 50W QPAR51

Variante	Art. Nr.
GU10 QPAR51	
■ schwarz	113492
GU10 QPAR51	
□ weiß	113512
GU10 QPAR51	
■ matt aluminium	111362

113492 486

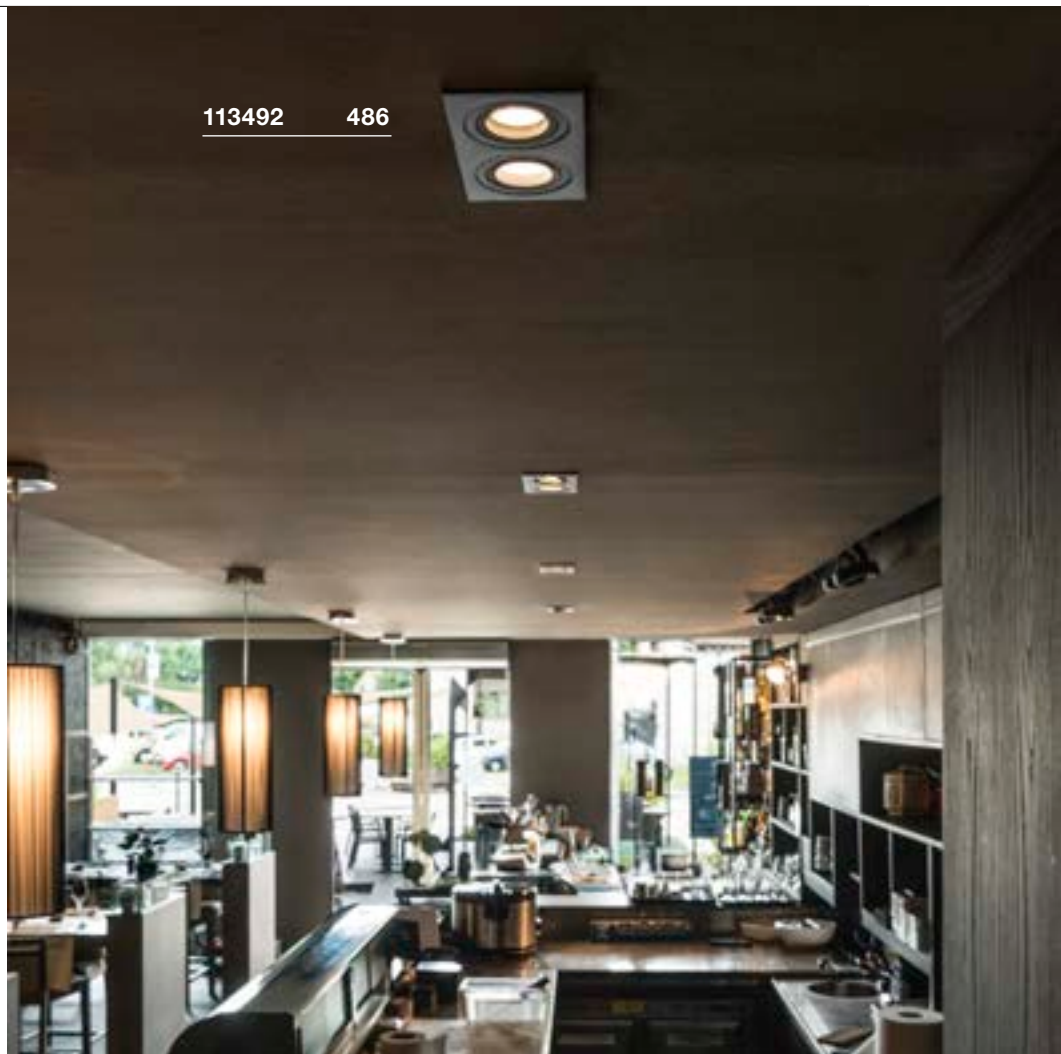

111380 487

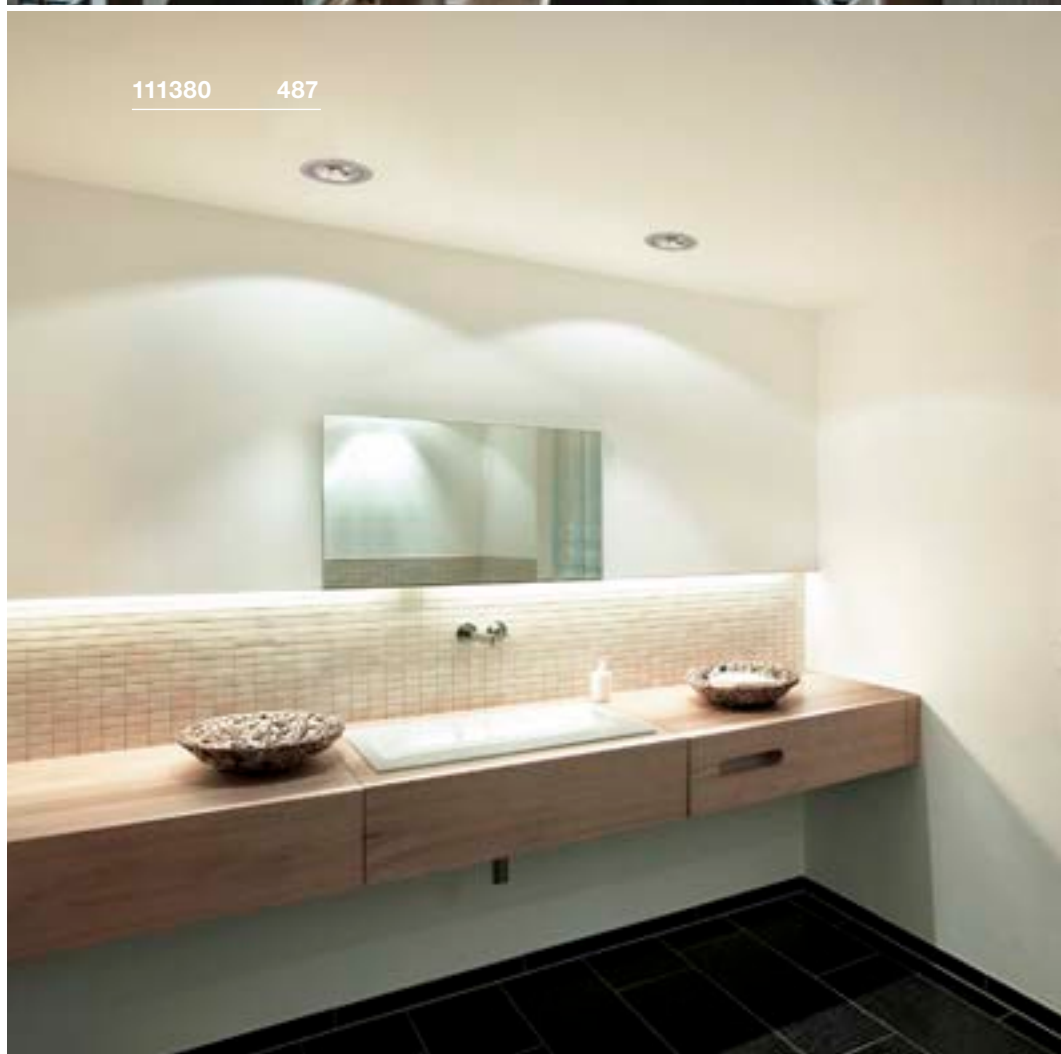

NEW TRIA 150
Single, round, LS, QPAR111

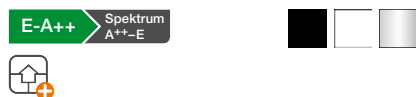

Produktangaben

230V ~50Hz
Material: Aluminium

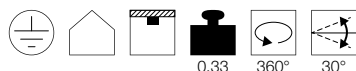

Maßzeichnung

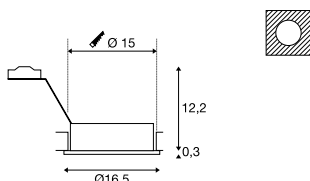

Hinweis

Blattfedern
Materialstärke Einbaufäche: 30 mm max

Leuchtmittlempfehlung

LED GU10 10W 38°
3000K 630lm EEK=A+
10kWh/1000h
Art. Nr. 1001029

LED GU10 7W 13°
3000K 660lm EEK=A+
8kWh/1000h
Art. Nr. 1001568

Leuchtmittelangaben

max. 75W QPAR111

Variante	Art. Nr.
GU10 QPAR111	
■ matt schwarz	113550
GU10 QPAR111	
□ matt weiß	113540
GU10 QPAR111	
■ aluminium	111380

NEW TRIA 150
Single, square, LS, QPAR111



Produktangaben

230V ~50Hz
Material: Aluminium

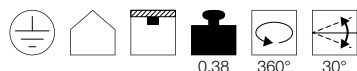

Maßzeichnung

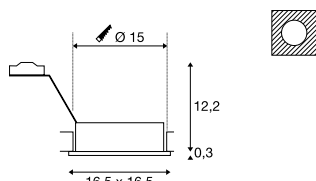

Hinweis

Blattfedern
Materialstärke Einbaufäche: 30 mm max

Leuchtmittlempfehlung

LED GU10 13W 30°
2700K 1100lm EEK=A+
13kWh/1000h
Art. Nr. 1001242

LED GU10 7,9W 40°
4000K 760lm EEK=A+
8kWh/1000h
Art. Nr. 560724

Leuchtmittelangaben

max. 75W QPAR111

Variante	Art. Nr.
GU10 QPAR111	
■ matt schwarz	113830
GU10 QPAR111	
□ matt weiß	113541
GU10 QPAR111	
■ matt aluminium	111381

NEW TRIA 300
Double, CS, QPAR111

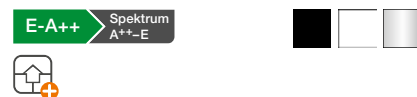

Produktangaben

230V ~50Hz
Material: Aluminium

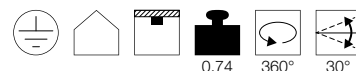

Maßzeichnung

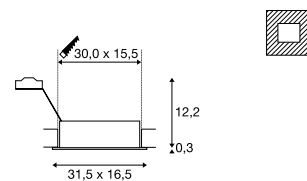

Hinweis

Clipfedern
Materialstärke Einbaufäche: 30 mm max

Leuchtmittlempfehlung

LED GU10 17,5W 140°
2700K 750lm EEK=A
18kWh/1000h
Art. Nr. 570532

LED GU10 9,5W 40°
2200-6700K 714lm
Art. Nr. 1001923

Leuchtmittelangaben

2x max. 75W QPAR111

Variante	Art. Nr.
GU10 QPAR111	
■ matt schwarz	113840
GU10 QPAR111	
□ matt weiß	113841
GU10 QPAR111	
■ matt aluminium	111382

NEW TRIA 45
Single, round, CS

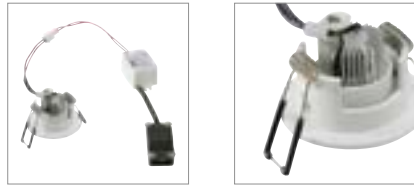

NEW TRIA 45
Single, square, CS

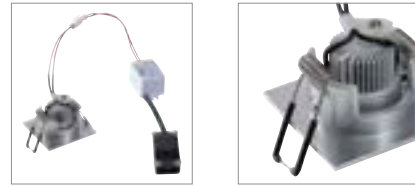

Produktangaben

220-240V ~50/60Hz | 700mA
Systemleistung: 4,4W
Material: Aluminium

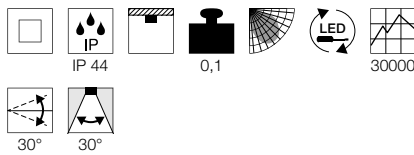

Maßzeichnung

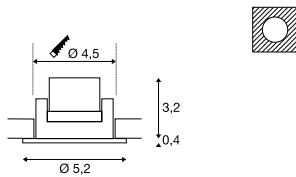

Hinweis

Clipfedern
Materialstärke Einbaufäche: 20 mm max

Produktangaben

220-240V ~50/60Hz | 700mA
Systemleistung: 4,4W
Material: Aluminium

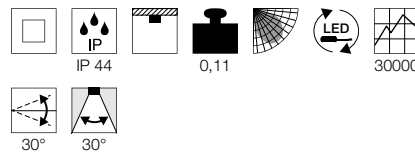

Maßzeichnung

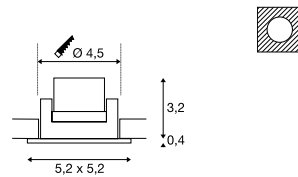

Hinweis

Clipfedern
Materialstärke Einbaufäche: 20 mm max

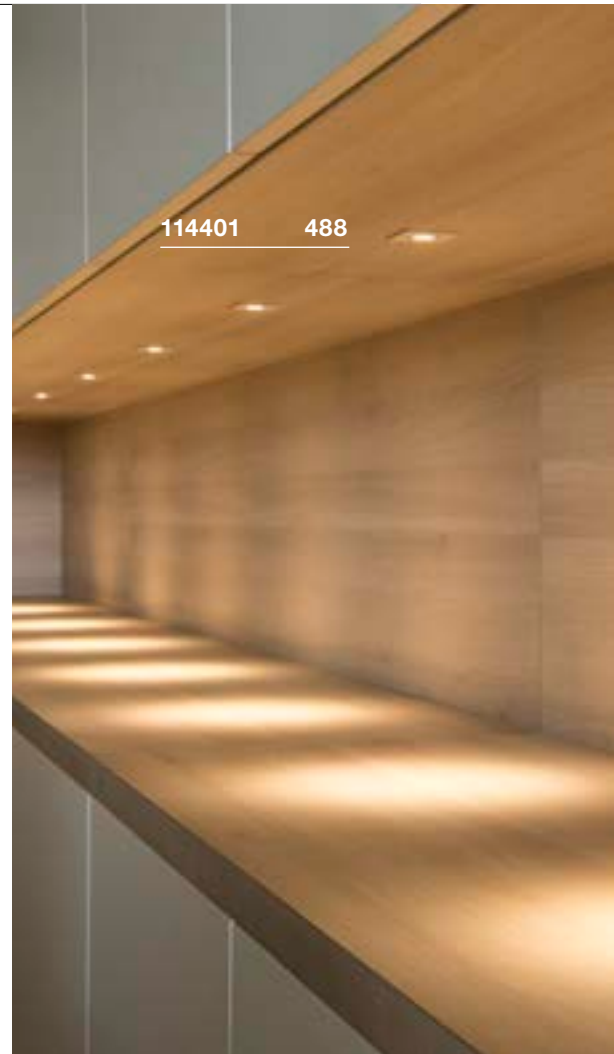

114401 488



113951 489

Variante	Art. Nr.
143lm 3000K CRI>80 ■ schwarz	113970
143lm 3000K CRI>80 □ matt weiß	113971
143lm 3000K CRI>80 ■ matt aluminium	113976

Variante	Art. Nr.
143lm 3000K CRI>80 ■ matt schwarz	114400
143lm 3000K CRI>80 □ matt weiß	114401
143lm 3000K CRI>80 ■ matt aluminium	114406



113951 489



1003058 489

NEW TRIA 68
Single, round, CS

A-A++ Spektrum A++-E

LED INSIDE

NEW VARIANT



- Premium LED
- Einbautiefe <40 mm
- Komfortabler Deckenausschnitt für Standard-Bohrkrone

Produktangaben

220-240V ~50/60Hz | 350mA
Systemleistung: 5,3W
Material: Aluminium

Icons: square, house, clip, beam, fan, LED, 40000, 30°, 38°

Maßzeichnung

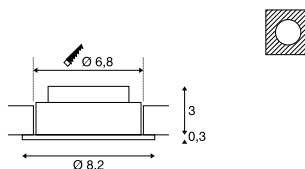

Hinweis

Clippfedern
Materialstärke Einbafläche: 20 m

Variante	Art. Nr.
300lm 3000K CRI80 ■ matt schwarz	1003057
300lm 2700K CRI80 ■ matt schwarz	1003058
300lm 2700K CRI80 □ matt weiß	1003059
300lm 2700K CRI80 ■ gebürstet aluminium	1003060
300lm 3000K CRI80 □ matt weiß	113951
300lm 3000K CRI80 ■ gebürstet aluminium	113956

NEW TRIA 68
Single, square, CS

A-A++ Spektrum A++-E

LED INSIDE

NEW VARIANT



- Premium LED
- Einbautiefe <40 mm
- Komfortabler Deckenausschnitt für Standard-Bohrkrone

Produktangaben

220-240V ~50/60Hz | 350mA
Systemleistung: 5,3W
Material: Aluminium

Icons: square, house, clip, beam, fan, LED, 40000, 38°, 38°

Maßzeichnung

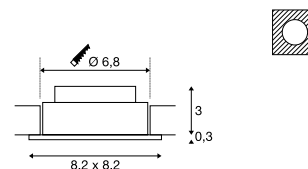

Hinweis

Clippfedern
Materialstärke Einbafläche: 20 m

Variante	Art. Nr.
300lm 3000K CRI80 ■ matt schwarz	1003061
300lm 2700K CRI80 ■ matt schwarz	1003062
300lm 2700K CRI80 □ matt weiß	1003063
300lm 2700K CRI80 ■ gebürstet aluminium	1003064
300lm 3000K CRI80 □ matt weiß	113961
300lm 3000K CRI80 ■ gebürstet aluminium	113966

NEW TRIA 68
EL, single, round, CS, TRIAC



Produktangaben

220-240V ~50/60Hz | 500mA
Systemleistung: 12W
Material: Aluminium
Dimmbar: Triac C, Triac L

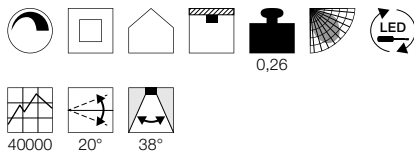

Maßzeichnung

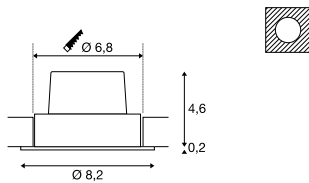

Hinweis

Clipfedern
Materialstärke Einbaulfläche: 20 m

Variante	Art. Nr.
800lm 2700K CRI>80 ■ matt aluminium	1003067
890lm 3000K CRI>80 ■ matt schwarz	114380
890lm 3000K CRI>80 □ matt weiß	114381
890lm 3000K CRI>80 ■ gebürstet aluminium	114386

NEW TRIA 68
Single, square, CS, TRIAC



• Einbautiefe <40mm

Produktangaben

220-240V ~50/60Hz | 500mA
Systemleistung: 11W
Material: Aluminium
Dimmbar: Triac C, Triac L

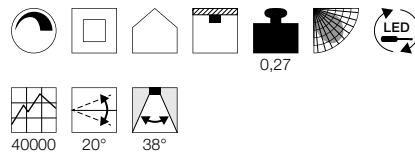

Maßzeichnung

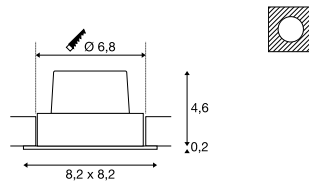

Hinweis

Clipfedern
Materialstärke Einbaulfläche: 20 m

Variante	Art. Nr.
800lm 2700K CRI>80 ■ matt schwarz	1003068
800lm 2700K CRI>80 □ matt weiß	1003069
890lm 2700K CRI>80 ■ matt aluminium	1003070
890lm 3000K CRI>80 ■ matt schwarz	114390
890lm 3000K CRI>80 □ matt weiß	114391
890lm 3000K CRI>80 ■ gebürstet aluminium	114396



114380 490

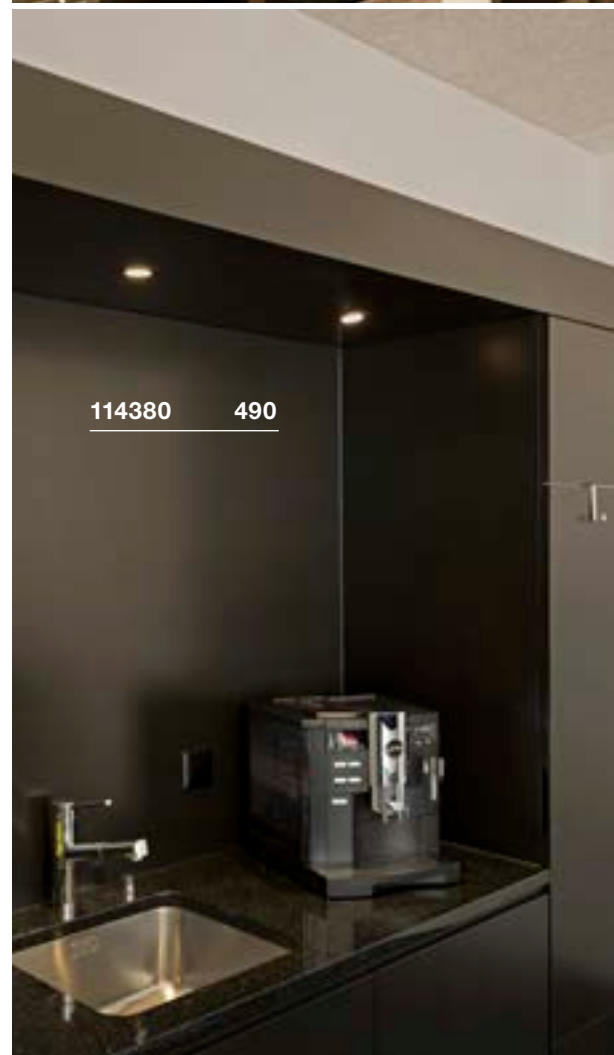

114380 490



1001989 491



1001991 491

NEW TRIA 68
Single, round, CS/LS, TRIAC

A-A++ Spektrum A++-E

LED INSIDE

Dim to Warm



- Premium LED mit CRI>90
- Dim to Warm (1800-3000K)
- Einbauhöhe <40mm

Produktangaben

220-240V ~50/60Hz | 350mA
Systemleistung: 7,3W
Material: Aluminium
Dimmbar: Triac C, Triac L

0,23

30000 30° 38°

Maßzeichnung

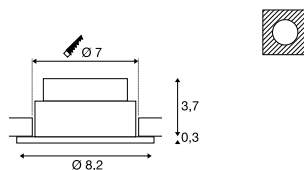

Hinweis

Materialstärke Einbaufäche: 20 m

Ein Anwendungsvideo zu Dim to Warm finden Sie un er <http://bit.ly/dim-to-warm>



NEW TRIA 68
Single, square, CS/LS, TRIAC

A-A++ Spektrum A++-E

LED INSIDE

Dim to Warm



- Premium LED mit CRI>90
- Dim to Warm (1800-3000K)
- Einbauhöhe <40mm

Produktangaben

220-240V ~50/60Hz | 350mA
Systemleistung: 7,3W
Material: Aluminium
Dimmbar: Triac C, Triac L

0,24

30000 30° 38°

Maßzeichnung

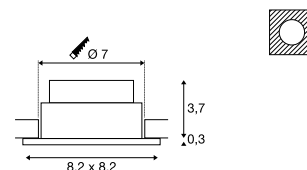

Hinweis

Materialstärke Einbaufäche: 20 m

Ein Anwendungsvideo zu Dim to Warm finden Sie un er <http://bit.ly/dim-to-warm>



Variante	Art. Nr.
440lm 1800-3000K CRI>95	
■ matt schwarz	1001978
440lm 1800-3000K CRI>95	
□ matt weiß	1001989
440lm 1800-3000K CRI>95	
■ matt aluminium	1001990

Variante	Art. Nr.
440lm 1800-3000K CRI>95	
■ schwarz	1001991
440lm 1800-3000K CRI>95	
□ matt weiß	1001992
440lm 1800-3000K CRI>95	
■ gebürstet aluminium	1001993

NEW TRIA 77
Single, round, CS



NEW TRIA 77
Single, square, CS

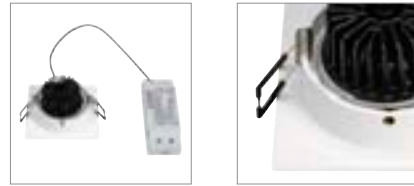

Produktangaben

220-240V ~50/60Hz | 350mA
Systemleistung: 8W
Material: Aluminium

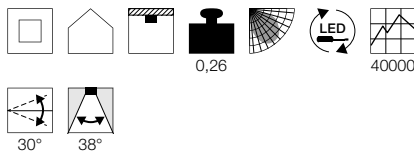

Produktangaben

220-240V ~50/60Hz | 350mA
Systemleistung: 8W
Material: Aluminium

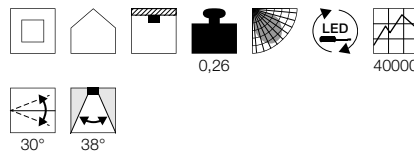

Maßzeichnung

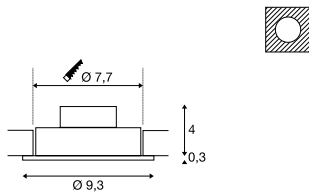

Maßzeichnung

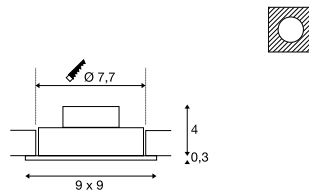

Hinweis

Clipfedern
Materialstärke Einbaufäche: 20 mm max

Hinweis

Clipfedern
Materialstärke Einbaufäche: 20 mm max

Variante	Art. Nr.
645lm 2700K CRI>80 ■ matt schwarz	113870
645lm 2700K CRI>80 □ weiß	113871
645lm 2700K CRI>80 ■ matt aluminium	113876
700lm 3000K CRI>80 ■ matt schwarz	113900
700lm 3000K CRI>80 □ weiß	113901
700lm 3000K CRI>80 ■ matt aluminium	113906

Variante	Art. Nr.
645lm 2700K CRI>80 ■ matt schwarz	113880
645lm 2700K CRI>80 □ weiß	113881
645lm 2700K CRI>80 ■ matt aluminium	113886
700lm 3000K CRI>80 ■ matt schwarz	113910
700lm 3000K CRI>80 □ weiß	113911
700lm 3000K CRI>80 ■ matt aluminium	113916



113916 492

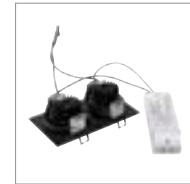

113890 493

NEW TRIA 155
Double, CSA-A++ Spektrum
A++-ELED
INSIDE

Produktangaben

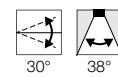
220-240V ~50/60Hz | 350mA
Systemleistung: 14W
Material: Aluminium

Maßzeichnung

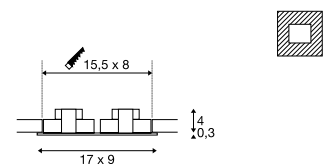

Hinweis

Clipfedern
Materialstärke Einbaufäche: 30 mm max

113926 493

Variante	Art. Nr.
1160lm 2700K CRI>80	
■ matt schwarz	113890
1160lm 2700K CRI>80	
□ weiß	113891
1160lm 2700K CRI>80	
■ matt aluminium	113896
1250lm 3000K CRI>80	
■ matt schwarz	113920
1250lm 3000K CRI>80	
□ weiß	113921
1250lm 3000K CRI>80	
■ matt aluminium	113926

114271 495

NEW TRIA 110

Single, round, CS, TRIAC

A-A++ Spektrum
A++-E



Produktangaben

220-240V ~50/60Hz | 350mA
Systemleistung: 15W
Material: Aluminium
Dimmbar: Triac C, Triac L

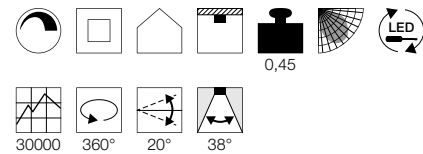

Maßzeichnung

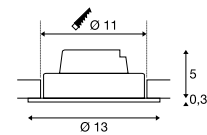

Hinweis

Clipfedern
Materialstärke Einbaufäche: 20 mm max

Variante	Art. Nr.
1010lm 2700K CRI>80	
■ schwarz	114220
1030lm 2700K CRI>80	
□ weiß	114221
1100lm 3000K CRI>80	
■ schwarz	114230
1120lm 3000K CRI>80	
□ weiß	114231

NEW TRIA 110
Single, square, CS, TRIAC

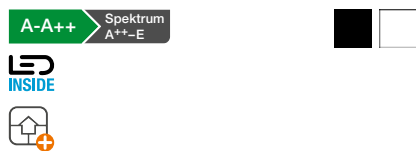

NEW TRIA 150
Single, round, CS, 1-10V



NEW TRIA 150
Single, square, CS, 1-10V



Produktangaben

220-240V ~50/60Hz | 350mA
Systemleistung: 15W
Material: Aluminium
Dimmbar: Triac C, Triac L

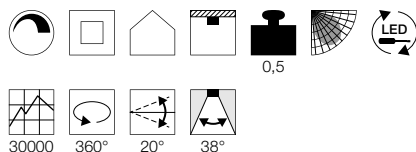

Maßzeichnung

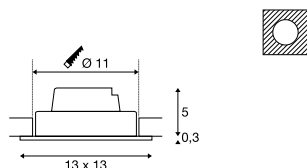

Hinweis

Clipfedern
Materialstärke Einbaufäche: 20 mm max

Produktangaben

100-240V ~50/60Hz | 700mA
Systemleistung: 29W
Material: Aluminium
Dimmbar: 1-10V

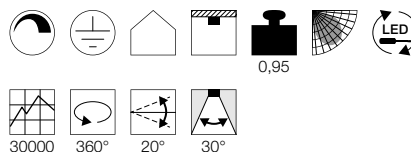

Maßzeichnung

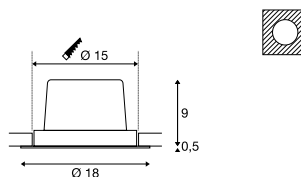

Hinweis

Clipfedern
Materialstärke Einbaufäche: 20 mm max

Produktangaben

100-240V ~50/60Hz | 700mA
Systemleistung: 29W
Material: Aluminium
Dimmbar: 1-10V

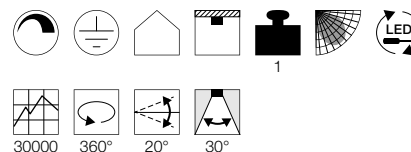

Maßzeichnung

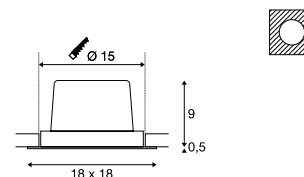

Hinweis

Clipfedern
Materialstärke Einbaufäche: 20 mm max

Variante	Art. Nr.
1010lm 2700K CRI>80 ■ schwarz	114240
1030lm 2700K CRI>80 □ weiß	114241
1100lm 3000K CRI>80 ■ schwarz	114250
1120lm 3000K CRI>80 □ weiß	114251

Variante	Art. Nr.
2210lm 2700K CRI>80 ■ schwarz	114260
2275lm 2700K CRI>80 □ weiß	114261
2425lm 3000K CRI>80 ■ schwarz	114270
2500lm 3000K CRI>80 □ weiß	114271

Variante	Art. Nr.
2210lm 2700K CRI>80 ■ schwarz	114280
2275lm 2700K CRI>80 □ weiß	114281
2425lm 3000K CRI>80 ■ schwarz	114290
2500lm 3000K CRI>80 □ weiß	114291

KADUX
EL, single, QPAR51

E-A++ Spektrum A++-E



KADUX
EL, double, QPAR51

E-A++ Spektrum A++-E

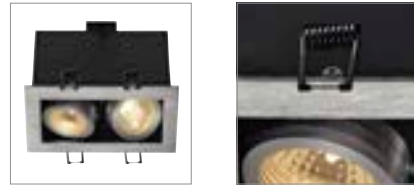

KADUX
EL, triple, QPAR51

E-A++ Spektrum A++-E



Produktangaben

230V ~50Hz
Material: Aluminium / Stahl

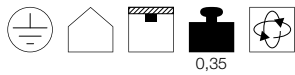

Produktangaben

230V ~50Hz
Material: Aluminium / Stahl

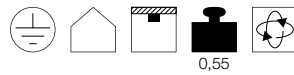

Produktangaben

230V ~50Hz
Material: Aluminium / Stahl

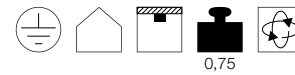

Maßzeichnung

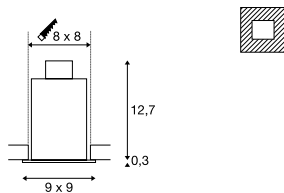

Maßzeichnung

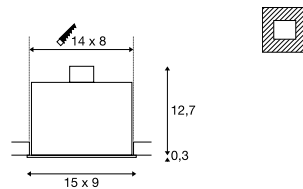

Maßzeichnung

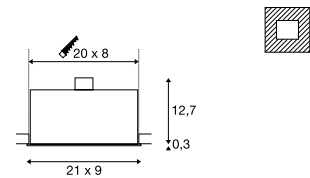

Hinweis

Materialstärke Einbaufäche: 30 mm max

Hinweis

Materialstärke Einbaufäche: 30 mm max

Hinweis

Materialstärke Einbaufäche: 30 mm max

Leuchtmittlempfehlung

LED GU10 5,5W 38°
2700K 400lm EEK=A+
6kWh/1000h
Art. Nr. 1001030



LED GU10 7,2W 36°
2700K 570lm EEK=A+
8kWh/1000h
Art. Nr. 560542



Leuchtmittlempfehlung

GU10 5,5W 36°
2800K 420lm EEK=A+
6kWh/1000h
Art. Nr. 1001217



LED GU10 5,6W 60°
2200-6700K 350lm EEK=A+
6kWh/1000h
Art. Nr. 1001919



Leuchtmittlempfehlung

LED GU10 7,2W 36°
4000K 540lm EEK=A+
8kWh/1000h
Art. Nr. 1001566



LED GU10 7,2W 36°
3000K 520lm EEK=A+
8kWh/1000h
Art. Nr. 1001563



Leuchtmittelangaben

max. 50W QPAR51

Leuchtmittelangaben

2x max. 50W QPAR51

Leuchtmittelangaben

3x max. 50W QPAR51

Variante	Art. Nr.
GU10 QPAR51	
■ matt schwarz	115510
GU10 QPAR51	
□ matt weiß	115511
GU10 QPAR51	
▒ matt aluminium	115516

Variante	Art. Nr.
GU10 QPAR51	
■ matt schwarz	115520
GU10 QPAR51	
□ matt weiß	115521
GU10 QPAR51	
▒ matt aluminium	115526

Variante	Art. Nr.
GU10 QPAR51	
■ matt schwarz	115530
GU10 QPAR51	
□ matt weiß	115531
GU10 QPAR51	
▒ matt aluminium	115536



115521 496

KADUX
EL, single, QPAR111

E-A++ Spektrum A++-E



Produktangaben

230V ~50Hz
Material: Aluminium / Stahl

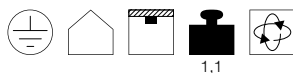

1,1

Maßzeichnung

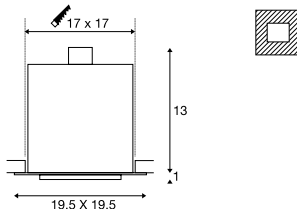

Hinweis

Materialstärke Einbaufäche: 25 mm max

Leuchtmittlempfehlung

LED GU10 10W 38°
3000K 630lm EEK=A+
10kWh/1000h
Art. Nr. 1001029



LED GU10 7W 13°
3000K 660lm EEK=A+
8kWh/1000h
Art. Nr. 1001568



Leuchtmittelangaben

max. 75W QPAR111

Variante	Art. Nr.
GU10 QPAR111	
■ matt schwarz	115540
□ matt weiß	115541
■ matt aluminium	115546



115536 496

KADUX
EL, double, QPAR111

E-A++ Spektrum A++-E



Produktangaben

230V ~50Hz
Material: Aluminium / Stahl

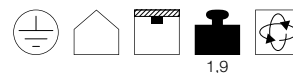

1,9

Maßzeichnung

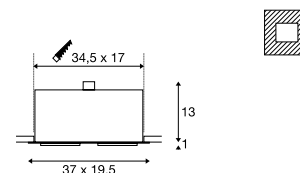

Hinweis

Materialstärke Einbaufäche: 25 mm max

Leuchtmittlempfehlung

GU10 9W 25°
2700-6500K 765lm EEK=A+
9kWh/1000h
Art. Nr. 1001920



LED GU10 9W 40°
2700-6500K 765lm EEK=A+
9kWh/1000h
Art. Nr. 1001921



Leuchtmittelangaben

2x max. 75W QPAR111

Variante	Art. Nr.
GU10 QPAR111	
■ matt schwarz	115550
□ matt weiß	115551
■ matt aluminium	115556

KADUX
EL, single, TRIAC



KADUX
EL, double, TRIAC



KADUX
EL, triple, TRIAC



Produktangaben

220-240V ~50/60Hz | 350mA
Systemleistung: 7,5W
Material: Aluminium / Stahl
Dimmbar: Triac C, Triac L

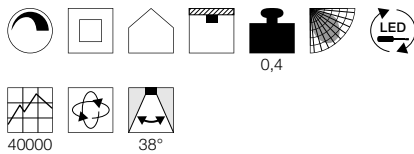

Maßzeichnung

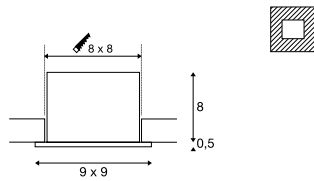

Hinweis

Materialstärke Einbaufäche: 30 mm max

Produktangaben

220-240V ~50/60Hz | 350mA
Systemleistung: 14W
Material: Aluminium / Stahl
Dimmbar: Triac C, Triac L

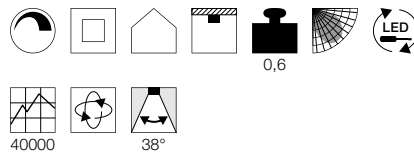

Maßzeichnung

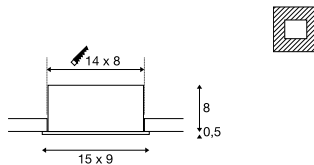

Hinweis

Materialstärke Einbaufäche: 30 mm max

Produktangaben

220-240V ~50/60Hz | 350mA
Systemleistung: 20W
Material: Aluminium / Stahl
Dimmbar: Triac C, Triac L

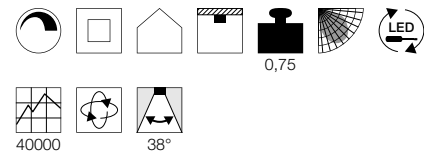

Maßzeichnung

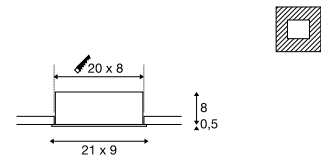

Hinweis

Materialstärke Einbaufäche: 30 mm max

Variante	Art. Nr.
650lm 3000K CRI>80	
■ matt schwarz	115700
650lm 3000K CRI>80	
□ matt weiß	115701
650lm 3000K CRI>80	
■ matt aluminium	115706

Variante	Art. Nr.
1290lm 3000K CRI>80	
■ matt schwarz	115710
1290lm 3000K CRI>80	
□ matt weiß	115711
1290lm 3000K CRI>80	
■ matt aluminium	115716

Variante	Art. Nr.
1920lm 3000K CRI>80	
■ matt schwarz	115720
1920lm 3000K CRI>80	
□ matt weiß	115721
1920lm 3000K CRI>80	
■ matt aluminium	115726



115700 498



115711 498

KADUX
EL, single, 1-10V

A-A++ Spektrum A++-E

LED INSIDE



KADUX
EL, double, 1-10V

A-A++ Spektrum A++-E

LED INSIDE



Produktangaben

100-240V ~50/60Hz | 700mA
Systemleistung: 29W
Material: Aluminium / Stahl
Dimmbar: 1-10V

1,6

30000 30°

Maßzeichnung

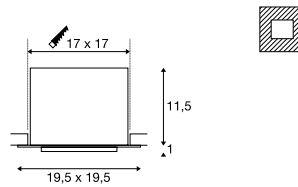

Hinweis

Materialstärke Einbaufäche: 25 mm max

Zubehörempfehlung

1-10V Dimming
Art. Nr. 470505

Variante	Art. Nr.
2425lm 3000K CRI>80	115730
■ matt schwarz	
2500lm 3000K CRI>80	115731
□ matt weiß	
2500lm 3000K CRI>80	115736
□ matt aluminium	

Produktangaben

100-240V ~50/60Hz | 1400mA
Systemleistung: 54W
Material: Aluminium / Stahl
Dimmbar: 1-10V

2,8

30000 30°

Maßzeichnung

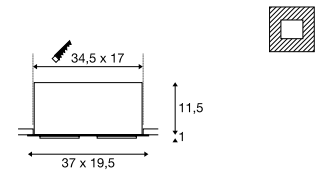

Hinweis

Materialstärke Einbaufäche: 25 mm max

Zubehörempfehlung

1-10V Dimming
Art. Nr. 470505

Variante	Art. Nr.
5200lm 3000K CRI>80	115740
■ matt schwarz	
5300lm 3000K CRI>80	115741
□ matt weiß	
5300lm 3000K CRI>80	115746
□ matt aluminium	

AIXLIGHT® PRO 50
LED Modul



A-A++ Spektrum A++-E



LED INSIDE

NEW VARIANT



AIXLIGHT® PRO 50
QPAR51 Modul



E-A++ Spektrum A++-E



Produktangaben

350mA | 13,3W
Material: Aluminium / Glas

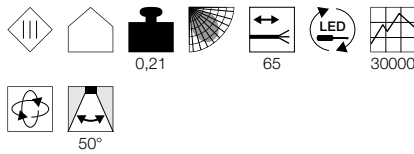

Maßzeichnung

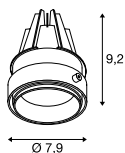

Hinweis

Treiber exkl.
Offenes Kabelend

Produktangaben

230V ~50Hz
Material: Aluminium / Kunststoff



Maßzeichnung

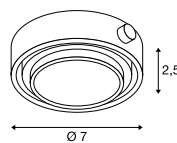

Leuchtmittelempfehlung

LED GU10 7,2W 36°
4000K 540lm EEK=A+
8kWh/1000h
Art. Nr. 1001566



LED GU10 5,1W 48°
2700-6500K 350lm EEK=A+
6kWh/1000h
Art. Nr. 1001918



Leuchtmittelangaben

max. 50W QPAR51
Ø: 5 cm max. L: 5,7 cm max.

Variante	Art. Nr.
1150lm 3000K CRI>80 ■ weiß / schwarz	1002598
1150lm 3000K CRI>80 ■ grau / schwarz	1002599
1185lm 4000K CRI>80 ■ weiß / schwarz	1002600
1185lm 4000K CRI>80 ■ grau / schwarz	1002601

Variante	Art. Nr.
GU10 QPAR51 ■ grau / schwarz	115414

AIXLIGHT® PRO 50
1 FRAME

Stahl
L: 10 cm B: 10 cm T: 10 cm
Gewicht: 0,33 kg
1 Stk.



Variante	Art. Nr.
■ grau / schwarz	115304

AIXLIGHT® PRO 50
2 FRAME

Stahl
L: 17,3 cm B: 10 cm T: 10 cm
Gewicht: 0,45 kg
1 Stk.



Variante	Art. Nr.
■ grau / schwarz	115314

AIXLIGHT® PRO 50
1 FRAMELESS

Stahl
L: 10,2 cm B: 10,2 cm T: 10,5 cm
Gewicht: 0,77 kg
1 Stk.



Variante	Art. Nr.
■ schwarz	115351

AIXLIGHT® PRO 50
2 FRAMELESS

Stahl
L: 18,8 cm B: 10,2 cm T: 10,5 cm
Gewicht: 1,09 kg
1 Stk.

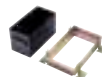

Variante	Art. Nr.
■ schwarz	115352



AIXLIGHT® PRO
EL, QPAR111 Modul



E-A++ Spektrum A++-E



Produktangaben

230V ~50Hz
Material: Aluminium / Kunststoff



Maßzeichnung

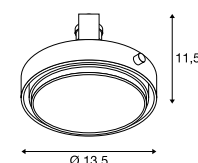

AIXLIGHT® PRO
1 FRAME

Stahl
L: 17,5 cm B: 17,5 cm T: 19 cm
Gewicht: 1 kg
1 Stk.



Variante	Art. Nr.
■ grau / schwarz	115104

AIXLIGHT® PRO
2 FRAMELESS

Stahl
L: 31,5 cm B: 15,5 cm T: 18,5 cm
Gewicht: 3,5 kg
1 Stk.



Variante	Art. Nr.
■ schwarz	115152

AIXLIGHT® PRO
2 FRAME

Stahl
L: 31,5 cm B: 17,5 cm T: 19 cm
Gewicht: 1,45 kg
1 Stk.



Variante	Art. Nr.
■ grau / schwarz	115114

AIXLIGHT® PRO
1 FRAMELESS

Stahl / Stahl
Ø: 15,5 cm T: 12 cm
Gewicht: 0,78 kg
1 Stk.

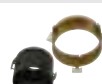

Variante	Art. Nr.
■ schwarz	115624

AIXLIGHT® PRO
1 FRAMELESS

Stahl
L: 15,5 cm B: 15,5 cm T: 18,5 cm
Gewicht: 2,15 kg
1 Stk.



Variante	Art. Nr.
■ schwarz	115151

AIXLIGHT® PRO
2 FRAMELESS

Stahl / Stahl
L: 32,5 cm B: 15,5 cm T: 12 cm
Gewicht: 1,72 kg
1 Stk.



Variante	Art. Nr.
■ schwarz	115634

Zubehörempfehlung

- Zierblende
Art. Nr. 115600
- Strukturglas
Art. Nr. 115170

Leuchtmittlempfehlung

- LED GU10 13W 140°
4000K 1100lm EEK=A+
13kWh/1000h
Art. Nr. 1001245
- LED GU10 9W 40°
2700-6500K 765lm EEK=A+
9kWh/1000h
Art. Nr. 1001921

Leuchtmittelangaben

max. 75W QPAR111

Variante	Art. Nr.
GU10 QPAR111 <input type="checkbox"/> matt weiß	115011
GU10 QPAR111 <input checked="" type="checkbox"/> grau / schwarz	115014

AIXLIGHT® PRO
EL, COB LED Modul



A-A++ Spektrum A++-E



Produktangaben

700mA/1000mA/1050mA | 39W
Material: Aluminium / Glas



Maßzeichnung

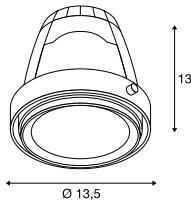

Hinweis

Verschiedene Störme möglich. 700mA, 25W, 2400lm – 1000/1050mA, 39W, 32000lm.
In unserem Kapitel Smart Home Lösungen finden Sie un erschiedliches VALETO® Zubehör passend zu Ihrer Transformator Auswahl.

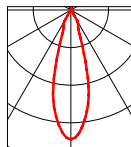

115203
115233

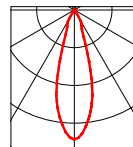

115213
115243

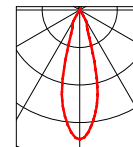

115223
115253

Zubehörempfehlung

■ LED Treiber 700mA | 40W inkl. Zulentlastung
Art. Nr. 464168



□ LED Treiber 350-1050mA | 50W | Dali 1-10V dimmbar
Art. Nr. 464032



□ LED Treiber 1050mA | 40W Triac Phasenabschnitt dimmbar
Art. Nr. 464804



■ LED Treiber 1000mA | 40W inkl. Zulentlastung
Art. Nr. 464170



□ LED Treiber 350-1050mA | 50W | Dali 1-10V dimmbar
Art. Nr. 464032



□ Zierblende
Art. Nr. 115600



Variante	Art. Nr.
2700/3500lm 3000K CRI>80 30°	
□ matt weiß	115183
2700/3500lm 3000K CRI>80 30°	
■ grau / schwarz	115193



AIXLIGHT® PRO
EL, COB LED Modul



A-A++ Spektrum A++-E



- Premium LED mit CRI>90
- Beleuchtung für Frischwaren und Kleidung

Produktangaben

700mA | 26W
Material: Aluminium / Glas



Maßzeichnung

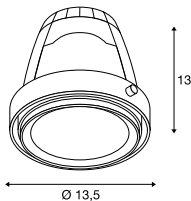

Hinweis

In unserem Kapitel Smart Home Lösungen finden Sie un unterschiedliches VALETO® Zubehör passend zu Ihrer Transformator Auswahl.

Zubehörempfehlung

■ LED Treiber 700mA | 40W inkl. Zugenlastung
Art. Nr. 464168

□ LED Treiber 350-1050mA | 50W | DALI 1-10V dimmbar
Art. Nr. 464032

□ Zierblende
Art. Nr. 115600



Variante	Art. Nr.
1950lm 4200K CRI>90 30° ■ weiß / schwarz	115203
1950lm 4200K CRI>90 30° ■ grau / schwarz	115233

AIXLIGHT® PRO
EL, COB LED Modul



A-A++ Spektrum A++-E



- Beleuchtung für Fleischwaren

Produktangaben

700mA | 26W
Material: Aluminium / Glas



Maßzeichnung

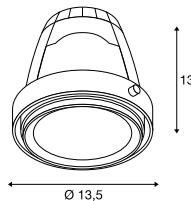

Hinweis

Dieses Produkt ist nicht zur allgemeinen Raumbeleuchtung geeignet, da dies ein Spezialprodukt für die Beleuchtung von Fleisch ist.
In unserem Kapitel Smart Home Lösungen finden Sie un unterschiedliches VALETO® Zubehör passend zu Ihrer Transformator Auswahl.
Farbkoordinaten: X=0,3759 Y=0,3287

Zubehörempfehlung

■ LED Treiber 700mA | 40W inkl. Zugenlastung
Art. Nr. 464168

□ LED Treiber 350-1050mA | 50W | DALI 1-10V dimmbar
Art. Nr. 464032

□ Zierblende
Art. Nr. 115600



Variante	Art. Nr.
1300lm 3600K CRI>65 30° ■ weiß / schwarz	115213
1300lm 3600K CRI>65 30° ■ grau / schwarz	115243

AIXLIGHT® PRO
EL, COB LED Modul



A-A++ Spektrum A++-E



- Premium LED mit CRI>90
- Beleuchtung für Backwaren

Produktangaben

700mA | 26W
Material: Aluminium / Glas



Maßzeichnung

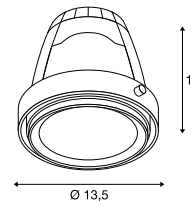

Hinweis

In unserem Kapitel Smart Home Lösungen finden Sie un unterschiedliches VALETO® Zubehör passend zu Ihrer Transformator Auswahl.

Zubehörempfehlung

■ LED Treiber 700mA | 40W inkl. Zugenlastung
Art. Nr. 464168

□ LED Treiber 350-1050mA | 50W | DALI 1-10V dimmbar
Art. Nr. 464032

□ Zierblende
Art. Nr. 115600



Variante	Art. Nr.
1650lm 3200K CRI>90 30° ■ weiß / schwarz	115223
1650lm 3200K CRI>90 30° ■ grau / schwarz	115253

SUPROS 78
EL, TRIAC

897

A-A++

Spektrum
A++-ELED
INSIDE

Produktangaben

220-240V ~50/60Hz | 250mA
 Systemleistung: 12W
 Material: Aluminium
 Dimmbar: Triac C, Triac L

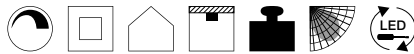

0,34

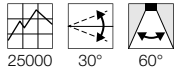

25000

30°

60°

Maßzeichnung

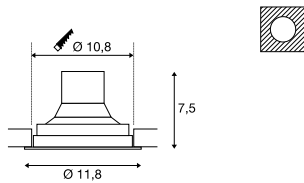

Hinweis

Materialstärke Einbaufäche: 25 mm max

Zubehörempfehlung

Linse 20°

Art. Nr. 116302

Linse 40°

Art. Nr. 116304

Variante	Art. Nr.
700lm 3000K CRI>80 ■ schwarz	116310
700lm 3000K CRI>80 □ weiß	116311



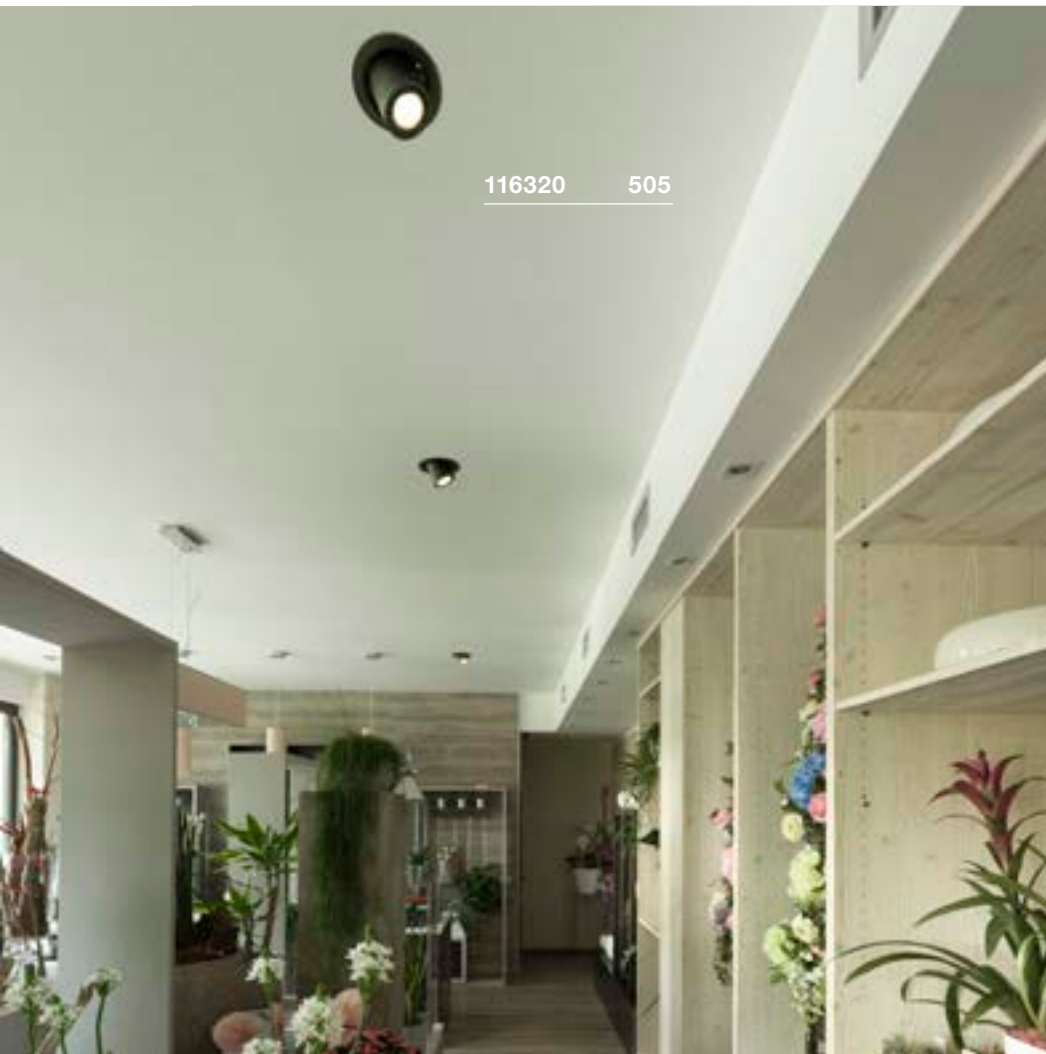

116320 505

SUPROS 78
EL, Move, TRIAC
 897
A-A++ Spektrum
A++-ELED
INSIDE

Produktangaben

220-240V ~50/60Hz | 250mA
Systemleistung: 12W
Material: Aluminium
Dimmbar: Triac C, Triac L

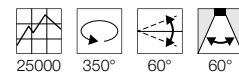
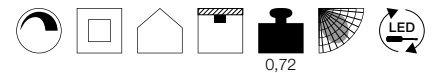

Maßzeichnung

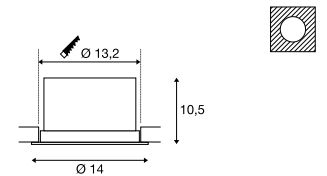

Hinweis

Materialstärke Einbaufäche: 25 mm max

Zubehörepfehlung

Linse 20°

Art. Nr. 116302

Linse 40°

Art. Nr. 116304

Variante

Art. Nr.

700lm | 3000K | CRI>80

■ schwarz

116320

700lm | 3000K | CRI>80

□ weiß

116321

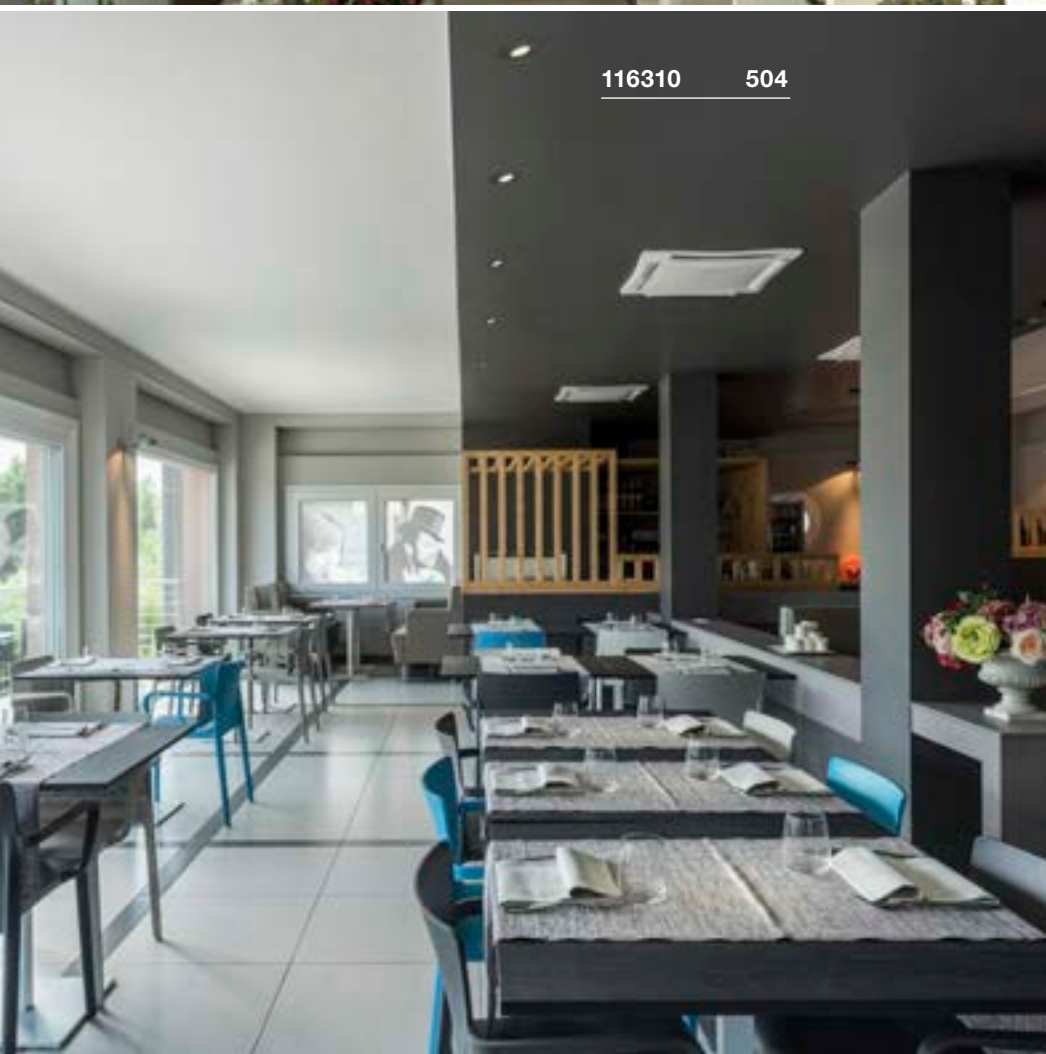

116310 504

SUPROS
EL

897

A-A++

Spektrum
A++-ELED
INSIDE

Produktangaben

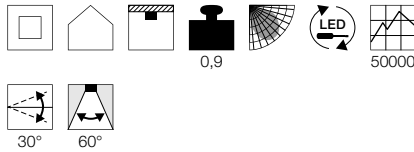
220-240V ~50/60Hz | 950mA
Material: Aluminium / Glas

Maßzeichnung

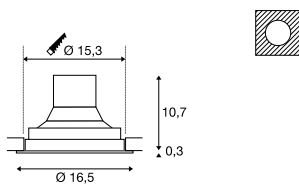

Hinweis

Materialstärke Einbaufäche: 25 mm max

Zubehöreffehlung

Reflek or 20°

Art. Nr. 114102



Reflek or 40°

Art. Nr. 114104



Variante	Art. Nr.
2600lm 3000K CRI>80 31W ■ schwarz	114110
2600lm 3000K CRI>80 31W □ weiß	114111
3100lm 3000K CRI>80 36W ■ schwarz	118110
3100lm 3000K CRI>80 36W □ weiß / transparent	118111
2850lm 4000K CRI>80 31W ■ schwarz	114160
2850lm 4000K CRI>80 31W □ weiß / transparent	114161
3300lm 4000K CRI>80 36W ■ schwarz	118160
3300lm 4000K CRI>80 36W □ weiß / transparent	118161

114110

506





114121 507

SUPROS
EL, Move

897

A-A++ Spektrum
A++-E



Produktangaben

220-240V ~50/60Hz | 950mA
Material: Aluminium / Glas

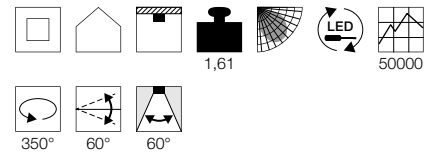

Maßzeichnung

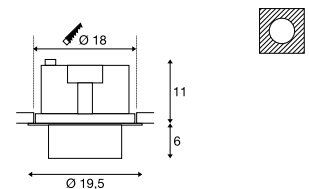

Hinweis

Materialstärke Einbaufäche: 25 m

Zubehöreffhlung

- Reflek or 20°
- Art. Nr. 114102
- Reflek or 40°
- Art. Nr. 114104

Variante	Art. Nr.
2600lm 3000K CRI>80 31W	
■ schwarz	114120
2600lm 3000K CRI>80 31W	
□ weiß	114121
3100lm 3000K CRI>80 36W	
■ schwarz	118120
3100lm 3000K CRI>80 36W	
□ weiß / transparent	118121
2850lm 4000K CRI>80 31W	
■ schwarz	114170
2850lm 4000K CRI>80 31W	
□ weiß / transparent	114171
3300lm 4000K CRI>80 36W	
■ schwarz	118170
3300lm 4000K CRI>80 36W	
□ weiß / transparent	118171

GIMBLE IN 68 EL

A-A++ Spektrum A++-E

LED INSIDE

NEW

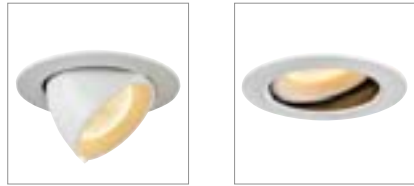

- Premium LED mit CRI>90
- Dreh- und schwenkbarer Lichtaustritt

Produktangaben

350mA | 6W
Material: Aluminium

0,11 30000

240° 45° 36°

Maßzeichnung

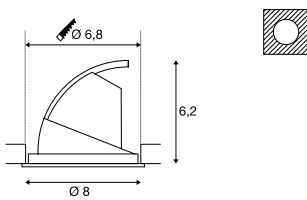

Hinweis

Materialstärke Einbaufäche: 20 m

Zubehörempfehlung

LED Treiber 350mA | 10W
Art. Nr. 464140

GIMBLE IN 100 EL

A-A++ Spektrum A++-E

LED INSIDE

NEW



- Premium LED mit CRI>90
- Dreh- und schwenkbarer Lichtaustritt

Produktangaben

350mA | 13W
Material: Aluminium

0,22 30000

240° 45° 36°

Maßzeichnung

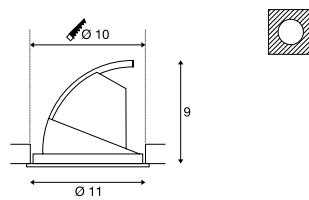

Hinweis

Materialstärke Einbaufäche: 25 m

Zubehörempfehlung

LED Treiber 350mA | 15W
Art. Nr. 464031

GIMBLE IN 150 EL

A-A++ Spektrum A++-E

LED INSIDE

NEW

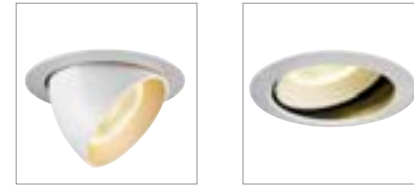

- Premium LED mit CRI>90
- Dreh- und schwenkbarer Lichtaustritt

Produktangaben

700mA | 25,5W
Material: Aluminium

0,55 30000

240° 50° 40°

Maßzeichnung

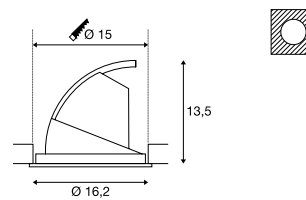

Hinweis

Materialstärke Einbaufäche: 30 m

Zubehörempfehlung

LED Treiber 40W | 700mA | 1-10V/
DALI dimmbar | inkl. Zugenlastung
Art. Nr. 1002424

Variante	Art. Nr.
520lm 3000K CRI>90 □ matt weiß	1002879
560lm 4000K CRI>90 □ matt weiß	1002885

Variante	Art. Nr.
990lm 3000K CRI>90 □ matt weiß	1002880
1140lm 4000K CRI>90 □ matt weiß	1002886

Variante	Art. Nr.
2300lm 3000K CRI>90 □ matt weiß	1002888
2490lm 4000K CRI>90 □ matt weiß	1002889

GIMBLE IN 175
ELA-A++ Spektrum
A++-ELED
INSIDE

NEW



- Premium LED mit CRI>90
- Dreh- und schwenkbarer Lichtaustritt

Produktangaben

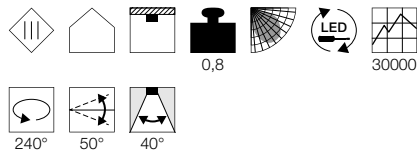
1000mA/1050mA | 38W
Material: Aluminium

Maßzeichnung

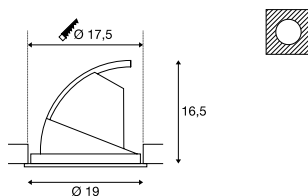

Hinweis

Materialstärke Einbaulfläche: 30 m

Zubehörempfehlung

 LED Treiber 1000mA | 40W |
TRIAC dimmbar | inkl. Zugentlastung

Art. Nr. 1001115

 LED Treiber 50W | 1050mA | 1-10V/
DALI dimmbar | inkl. Zugentlastung

Art. Nr. 1002425

Variante	Art. Nr.
3340lm 3000K CRI>90 <input type="checkbox"/> matt weiß	1002881
3550lm 4000K CRI>90 <input type="checkbox"/> matt weiß	1002887

1002880 508



SENSER 12
EL, round



A-A++ Spektrum
A++-E

- Geringe Einbautiefe

Produktangaben

Material: Aluminium

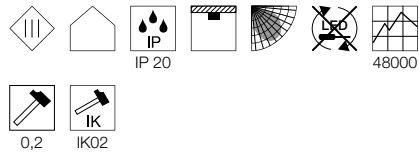

SENSER 12
EL, round



SENSER 18
EL, round



SENSER 24
EL, round



Variante	Art. Nr.
470lm 3000K CRI>80 200mA 6W Ø: 11,5 cm H: 2 cm 0,1 kg <input type="checkbox"/> matt weiß	1003008

Variante	Art. Nr.
950lm 3000K CRI>80 350mA 9,7W Ø: 16,5 cm H: 2 cm 0,18 kg <input type="checkbox"/> matt weiß	1003009

Variante	Art. Nr.
1200lm 3000K CRI>80 500mA 12,5W Ø: 21,5 cm H: 2 cm 0,29 kg <input type="checkbox"/> matt weiß	1003010



SENSER 12
EL, square



A-A++ Spektrum
A++-E

- Geringe Einbautiefe

Produktangaben

Material: Aluminium

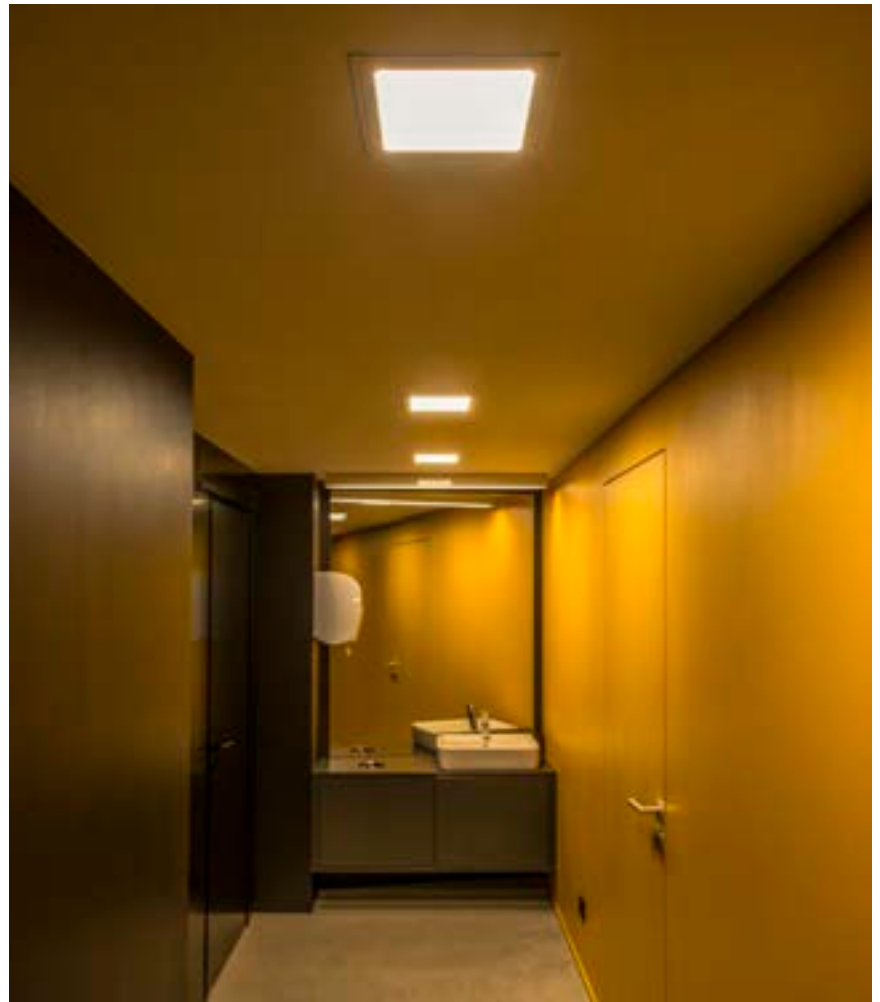
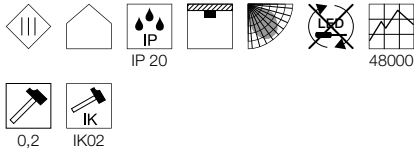

SENSER 12
EL, square



Variante	Art. Nr.
440lm 3000K CRI>80 200mA 6W L: 11,5 cm B: 11,5 cm H: 2 cm 0,12 kg □ matt weiß	1003011

SENSER 18
EL, square



Variante	Art. Nr.
820lm 3000K CRI>80 350mA 9,7W L: 16,5 cm B: 16,5 cm H: 2 cm 0,22 kg □ matt weiß	1003012

SENSER 24
EL, square



Variante	Art. Nr.
1200lm 3000K CRI>80 500mA 12,5W L: 21,5 cm B: 21,5 cm H: 2 cm 0,36 kg □ matt weiß	1003013

VERLUX EL, square, TRIAC

A-A++ Spektrum
A++-E



Produktangaben

220-240V ~50/60Hz | 500mA
Systemleistung: 12W
Material: Aluminium / Kunststoff
Dimmbar: Triac C, Triac L



0,15

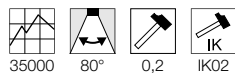

Maßzeichnung

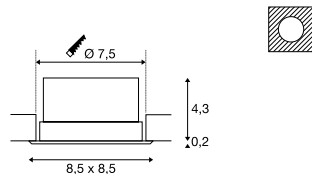

Hinweis

Materialstärke Einbafläche: 30 mm max
Kann mit VALETO® Switch Box 420012
in das VALETO® System integriert werden.

Variante	Art. Nr.
880lm 3000K CRI>80 □ matt weiß	112682

1000795 513

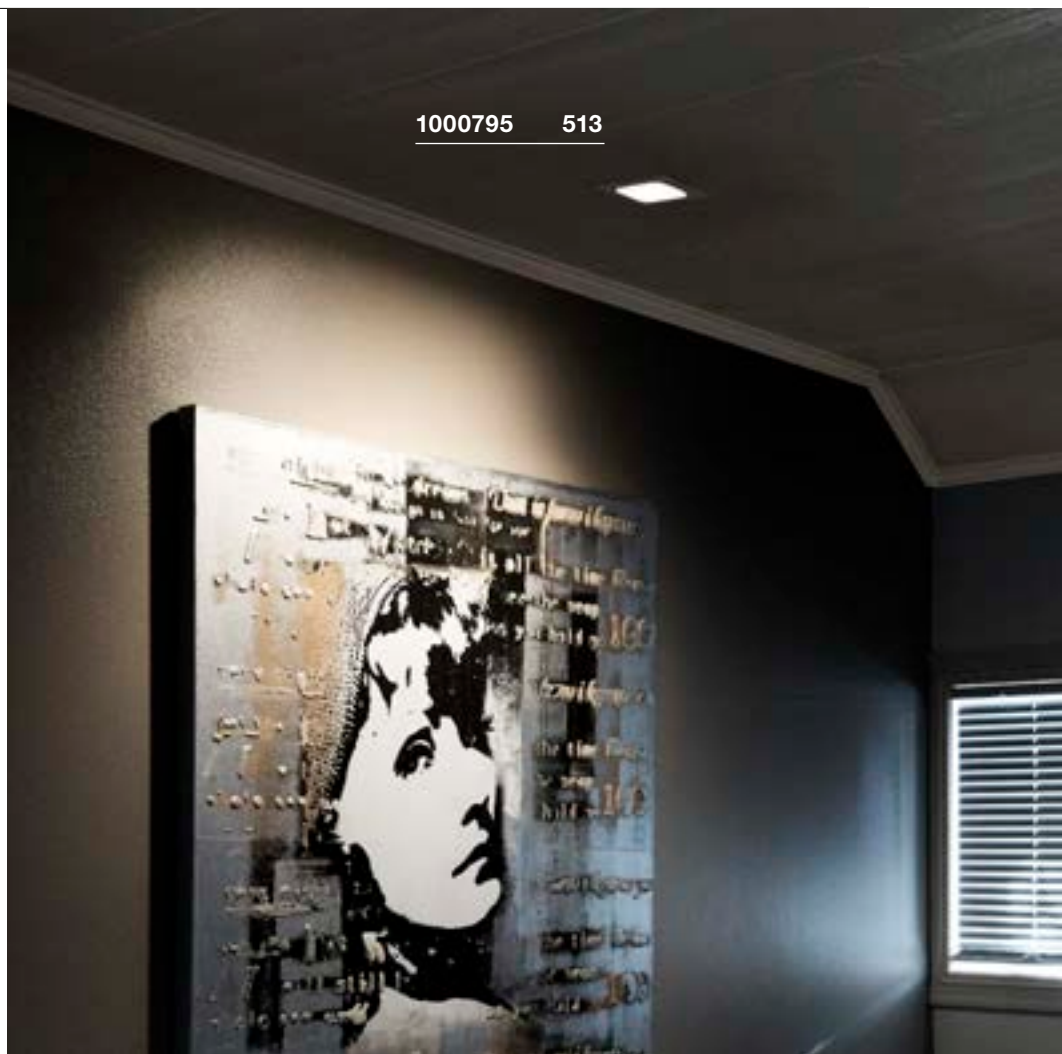

112702 513

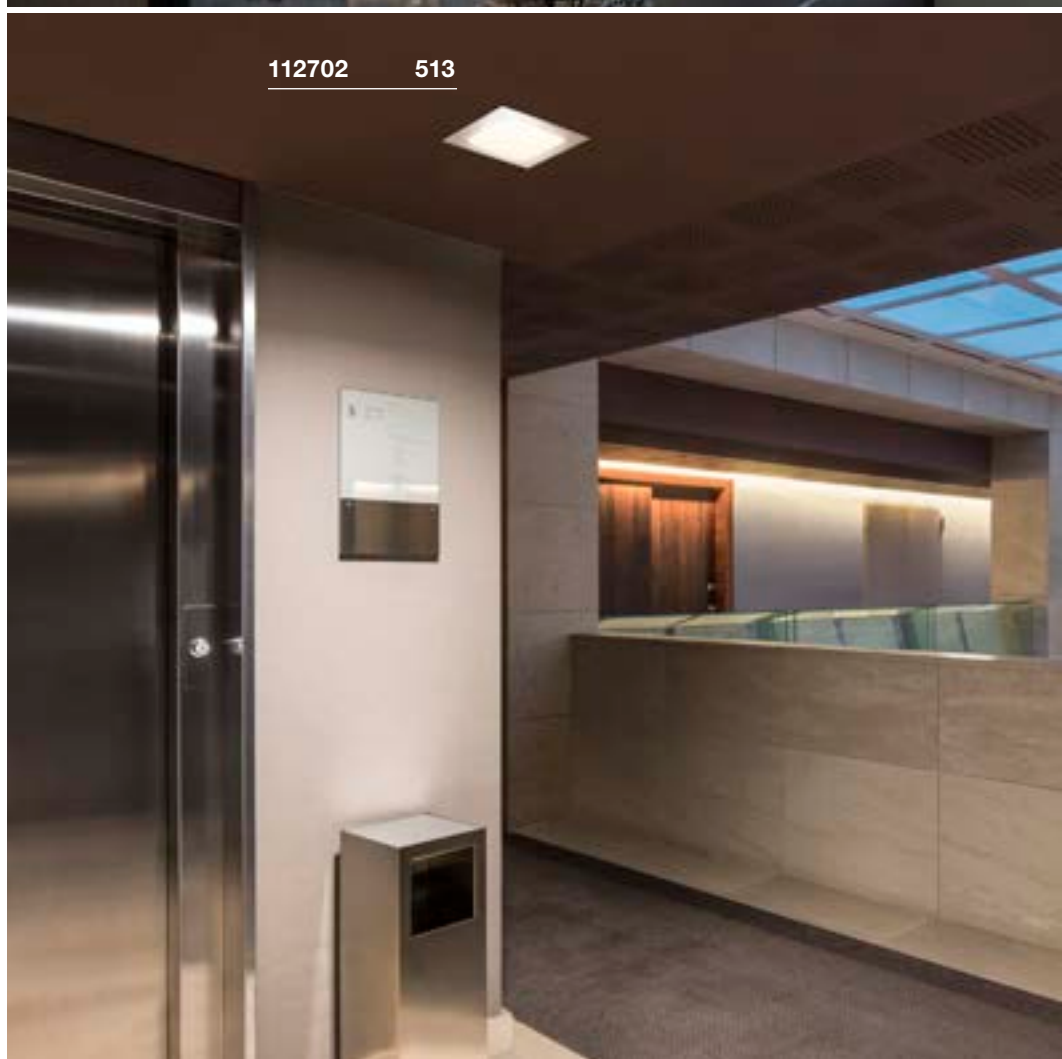

VERLUX
EL, square, TRIAC



VERLUX
EL, square, TRIAC

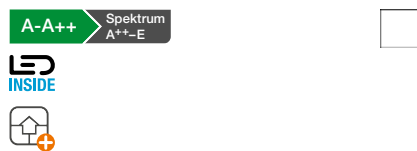

VERLUX
EL, square, TRIAC



• Asymetrischer Lichtaustritt

Produktangaben

220-240V ~50/60Hz | 500mA
Systemleistung: 22W
Material: Aluminium / Kunststoff
Dimmbar: Triac C, Triac L

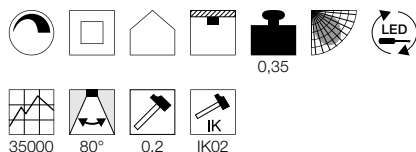

35000 80° 0,2 IK02

Maßzeichnung

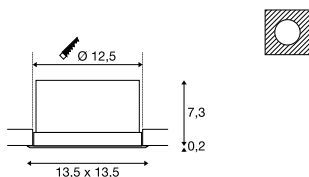

Hinweis

Materialstärke Einbaufäche: 30 mm max
Kann mit VALETO® Switch Box 420012
in das VALETO® System integriert werden.

Produktangaben

220-240V ~50/60Hz | 700mA
Systemleistung: 31W
Material: Aluminium / Kunststoff
Dimmbar: Triac C, Triac L

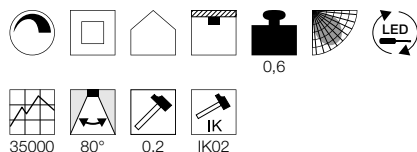

35000 80° 0,2 IK02

Maßzeichnung

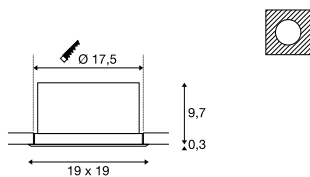

Hinweis

Materialstärke Einbaufäche: 30 mm max
Kann mit VALETO® Switch Box 420012
in das VALETO® System integriert werden.

Produktangaben

220-240V ~50/60Hz | 350mA
Material: Aluminium / Kunststoff
Dimmbar: Triac C, Triac L

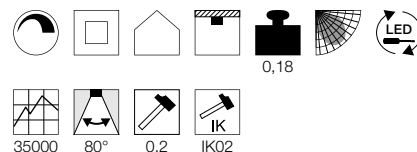

35000 80° 0,2 IK02

Maßzeichnung

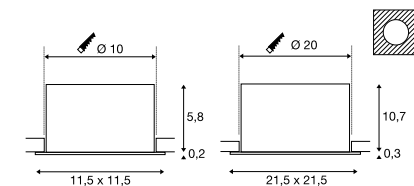

Hinweis

Materialstärke Einbaufäche: 25 mm max

Variante	Art. Nr.
1800lm 3000K CRI>80 □ matt weiß	112692

Variante	Art. Nr.
2360lm 3000K CRI>80 □ matt weiß	112702

Variante	Art. Nr.
650lm 3000K CRI>80 8,6W L: 11,5 cm B: 11,5 cm H: 6 cm □ weiß	1000795
1370lm 3000K CRI>80 16W L: 21,5 cm B: 21,5 cm H: 11 cm □ weiß	1000796

RILO
ELA-A++ Spektrum
A++-ELED
INSIDE

- Premium LED mit CRI>90
- Farbtemperatur (3000K/4000K) über Schalter einstellbar.
- UGR<19

Produktangaben

220-240V ~50/60Hz

Material: Aluminium / Polycarbonat (PC)

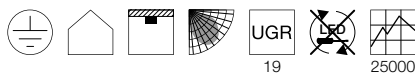

19

25000



60°

Maßzeichnung

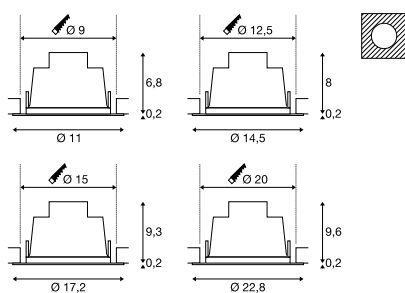

Hinweis

Farbtemperatur kann während der Installation über einen an der Leuchte befestigten Schalter eingestellt werden

Materialstärke Einbaufäche: 35 mm

Variante	Art. Nr.
350/400lm 3000/4000K CRI>90 6W Ø: 11 cm 0,16 kg weiß / chrom	1001973
800/850lm 3000/4000K CRI>90 13W Ø: 14,5 cm 0,26 kg weiß / chrom	1001974
1200/1300lm 3000/4000K CRI>90 18W Ø: 17,2 cm 0,36 kg weiß / chrom	1001975
1550/1600lm 3000/4000K CRI>90 21W Ø: 22,8 cm 0,56 kg weiß / chrom	1001976

1001976 514

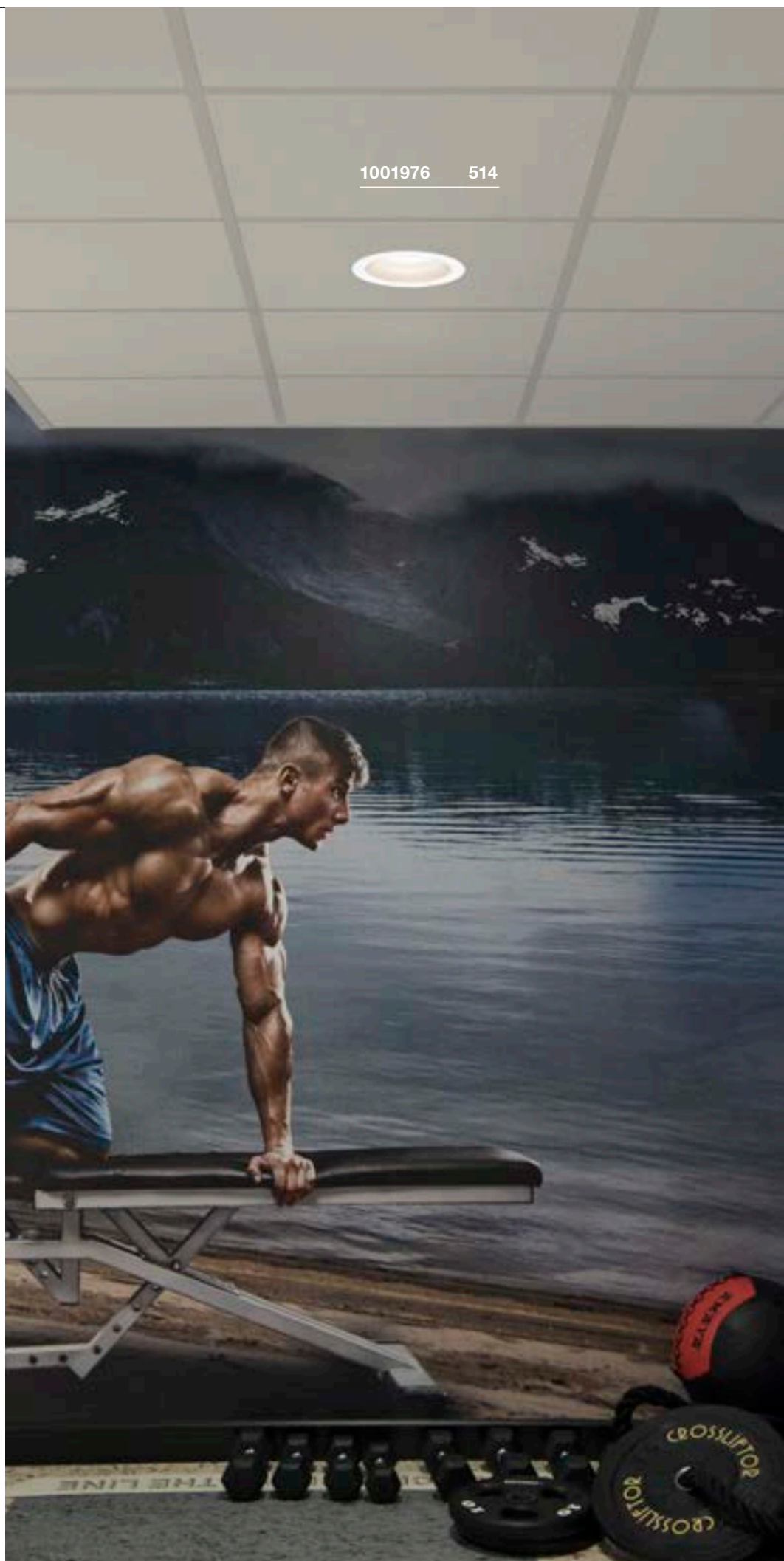

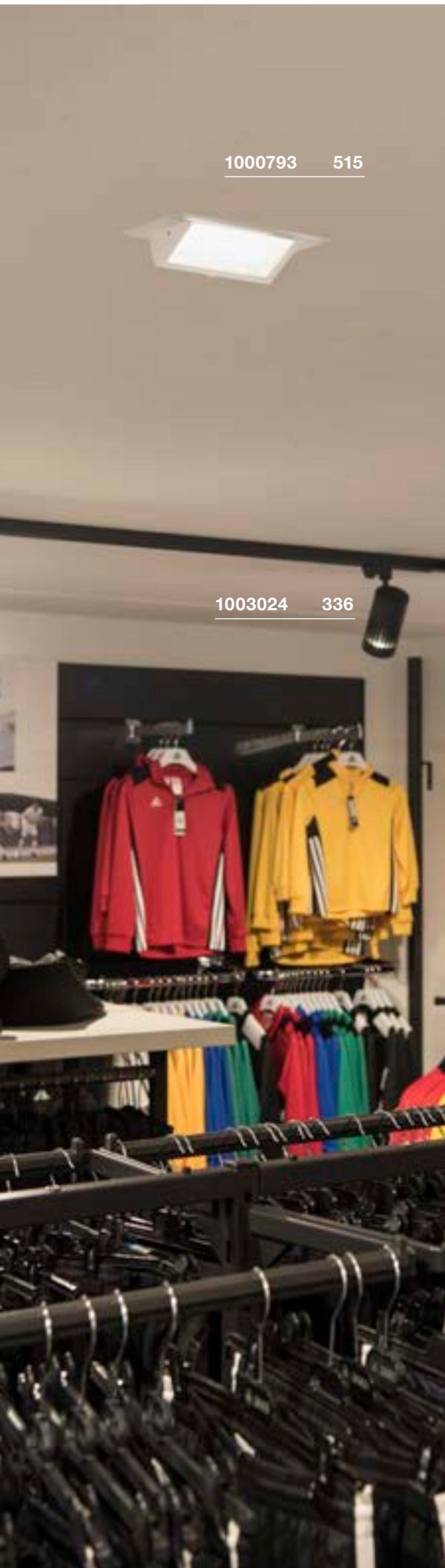

1000793 515

1003024 336

ALAMEA EL

A-A++ Spektrum A++-E



- Premium LED mit CRI>90
- Großer Schwenkbereich

Produktangaben

Material: Aluminium/Glas

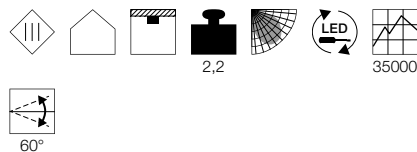

Maßzeichnung

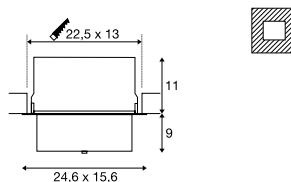

Hinweis

Materialstärke Einbaufäche: 40 mm max

Zubehörempfehlung

■ LED Treiber 1000mA | 40W inkl. Zugentlastung
Art. Nr. 464170

□ LED Treiber 350-1050mA | 50W | DALI 1-10V dimmbar
Art. Nr. 464032

□ LED Treiber 1000mA | 40W | TRIAC dimmbar | inkl. Zugentlastung
Art. Nr. 1001115



ALAMEA EL

A-A++ Spektrum A++-E



- Premium LED mit CRI>90
- Großer Schwenkbereich

Produktangaben

Material: Aluminium/Glas

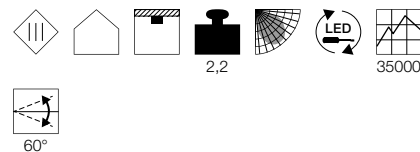

Maßzeichnung

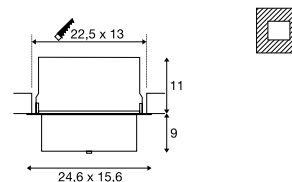

Hinweis

Materialstärke Einbaufäche: 40 mm max

Zubehörempfehlung

■ LED Treiber 700mA | 40W inkl. Zugentlastung
Art. Nr. 464168

□ LED Treiber 350-1050mA | 50W | DALI 1-10V dimmbar
Art. Nr. 464032

□ LED Treiber 700mA | 40W | TRIAC dimmbar | inkl. Zugentlastung
Art. Nr. 1001114



Variante	Art. Nr.
2900lm 700mA 29,4W 3000K CRI>90	
□ weiß	1000791
3600lm 1000mA 36W 3000K CRI>90	
□ weiß	1000792

Variante	Art. Nr.
2750lm 700mA 29,4W 4000K CRI>90	
□ weiß	1000793
3800lm 1000mA 36W 4000K CRI>90	
□ weiß	1000794

1000388 517

143440 391

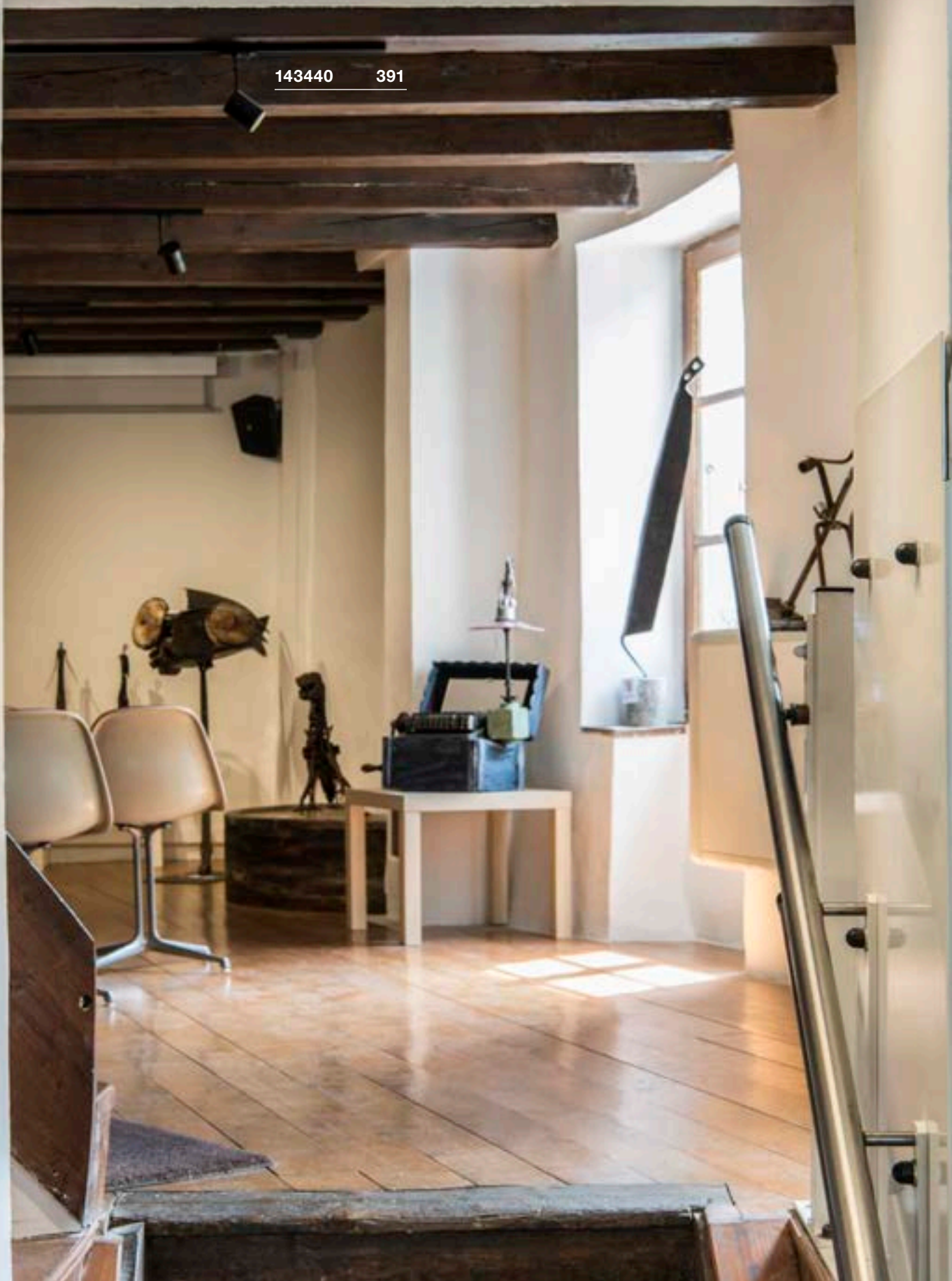

MEDO 30
EL, FRAMELESS



A-A++ Spektrum
A++-E



- Farbtemperatur (3000K/4000K)
über Schalter einstellbar

Produktangaben

350mA | 14W
Material: Aluminium / Polymethylacrylat (PMMA)
Einbaumaße: T: 13 cm

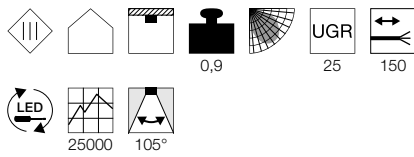

Maßzeichnung

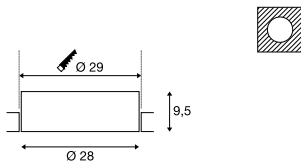

Hinweis

Offenes Kabelend
Materialstärke Einbaufäche: 45 mm

Zubehöreffelung

LED Treiber 20W | 350mA |
inkl. Zugenlastung

Art. Nr. 1002420

LED Treiber 20W | 350mA | 1-10V/
DALI dimmbar | inkl. Zugenlastung

Art. Nr. 1002423

LED Treiber 20W | 350mA |
TRIAC dimmbar | inkl. Zugenlastung

Art. Nr. 1002232

Variante	Art. Nr.
1500/1600lm 3000/4000K CRI>80	
weiß	1001901



MEDO 40
EL, FRAMELESS



A-A++ Spektrum A++-E



- Farbtemperatur (3000K/4000K) über Schalter einstellbar

Produktangaben

700mA | 18W
Material: Aluminium / Polymethylacrylat (PMMA)
Einbaumaße: T: 13 cm

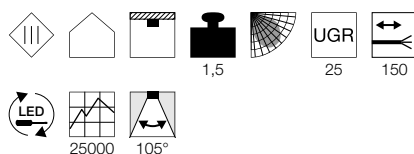

Maßzeichnung

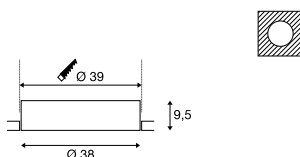

Hinweis

Offenes Kabelend
Materialstärke Einbaufäche: 45 m

Zubehörempfehlung

- LED Treiber 700mA | 40W inkl. Zugentlastung
Art. Nr. 464168
- LED Treiber 40W | 700mA | 1-10V/ DALI dimmbar | inkl. Zugentlastung
Art. Nr. 1002424

Variante	Art. Nr.
3100/3300lm 3000/4000K CRI>80	
□ weiß	1001902

MEDO 60
EL, FRAMELESS



A-A++ Spektrum A++-E



- Farbtemperatur (3000K/4000K) über Schalter einstellbar

Produktangaben

1000mA/1050mA | 28W
Material: Aluminium / Polymethylacrylat (PMMA)
Einbaumaße: T: 16 cm

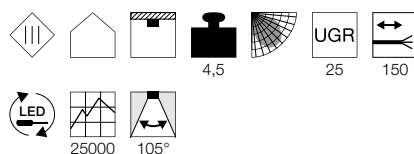

Maßzeichnung

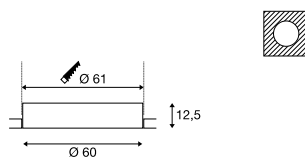

Hinweis

Offenes Kabelend
Materialstärke Einbaufäche: 45 m

Zubehörempfehlung

- LED Treiber 60W | 1000mA | inkl. Zugentlastung
Art. Nr. 1002422
- LED Treiber 50W | 1050mA | 1-10V/ DALI dimmbar | inkl. Zugentlastung
Art. Nr. 1002425
- LED Treiber 1000mA | 40W | TRIAC dimmbar | inkl. Zugentlastung
Art. Nr. 1001115

Variante	Art. Nr.
4700/5000lm 3000/4000K CRI>80	
□ weiß	1001903

MEDO 90
EL, FRAMELESS



A-A++ Spektrum A++-E

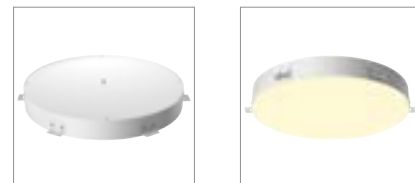

- Farbtemperatur (3000K/4000K) über Schalter einstellbar

Produktangaben

1000mA/1050mA | 36W
Material: Aluminium / Polymethylacrylat (PMMA)
Einbaumaße: T: 21 cm

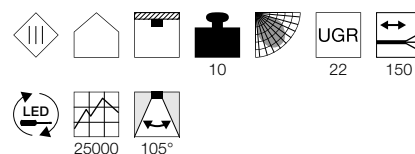

Maßzeichnung

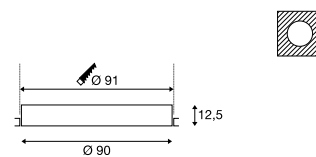

Hinweis

Offenes Kabelend
Materialstärke Einbaufäche: 45 m

Zubehörempfehlung

- LED Treiber 60W | 1000mA | inkl. Zugentlastung
Art. Nr. 1002422
- LED Treiber 50W | 1050mA | 1-10V/ DALI dimmbar | inkl. Zugentlastung
Art. Nr. 1002425
- LED Treiber 1000mA | 40W | TRIAC dimmbar | inkl. Zugentlastung
Art. Nr. 1001115

Variante	Art. Nr.
9550/10150lm 3000/4000K CRI>80	
□ weiß	1001904

MEDO 30
EL, FRAME



A-A++ Spektrum A++-E



- Farbtemperatur (3000K/4000K) über Schalter einstellbar

Produktangaben

350mA | 14W
Material: Aluminium / Polymethylacrylat (PMMA)
Einbaumaße: T: 13 cm

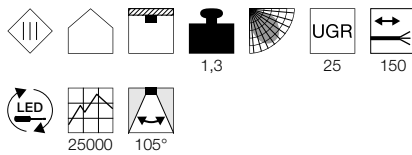

Maßzeichnung

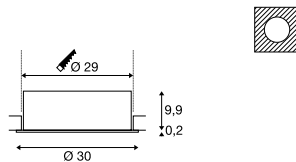

Hinweis

Offenes Kabelend
Materialstärke Einbaufäche: 10-35 m

Zubehörempfehlung

- LED Treiber 20W | 350mA | inkl. Zulentlastung
Art. Nr. 1002420
- LED Treiber 20W | 350mA | 1-10V/ DALI dimmbar | inkl. Zulentlastung
Art. Nr. 1002423
- LED Treiber 20W | 350mA | TRIAC dimmbar | inkl. Zulentlastung
Art. Nr. 1002232

MEDO 40
EL, FRAME



A-A++ Spektrum A++-E



- Farbtemperatur (3000K/4000K) über Schalter einstellbar

Produktangaben

700mA | 18W
Material: Aluminium / Polymethylacrylat (PMMA)
Einbaumaße: T: 13 cm

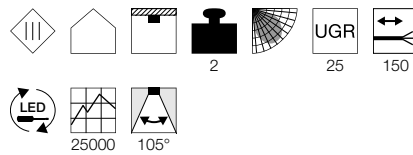

Maßzeichnung

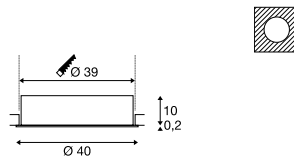

Hinweis

Offenes Kabelend
Materialstärke Einbaufäche: 10-35 m

Zubehörempfehlung

- LED Treiber 700mA | 40W inkl. Zulentlastung
Art. Nr. 464168
- LED Treiber 40W | 700mA | 1-10V/ DALI dimmbar | inkl. Zulentlastung
Art. Nr. 1002424

Variante	Art. Nr.
3100/3300lm 3000/4000K CRI>80	1001906
□ weiß	

MEDO 60
EL, FRAME



A-A++ Spektrum A++-E



- Farbtemperatur (3000K/4000K) über Schalter einstellbar

Produktangaben

1000mA/1050mA | 28W
Material: Aluminium / Polymethylacrylat (PMMA)
Einbaumaße: T: 16 cm

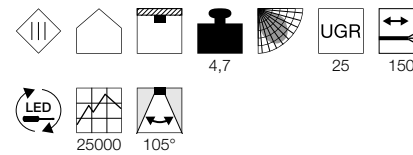

Maßzeichnung

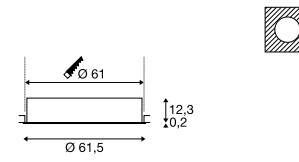

Hinweis

Offenes Kabelend
Materialstärke Einbaufäche: 10-35 m

Zubehörempfehlung

- LED Treiber 60W | 1000mA | inkl. Zulentlastung
Art. Nr. 1002422
- LED Treiber 50W | 1050mA | 1-10V/ DALI dimmbar | inkl. Zulentlastung
Art. Nr. 1002425
- LED Treiber 1000mA | 40W | TRIAC dimmbar | inkl. Zulentlastung
Art. Nr. 1001115

Variante	Art. Nr.
4700/5000lm 3000/4000K CRI>80	1001907
□ weiß	

**MEDO 90**
EL, FRAME**A-A++** Spektrum
A++-E**LED**
INSIDENEW
VARIANT

- Farbtemperatur (3000K/4000K)
über Schalter einstellbar

Produktangaben

1000mA/1050mA | 36W
Material: Aluminium / Polymethylacrylat (PMMA)
Einbaumaße: T: 21 cm

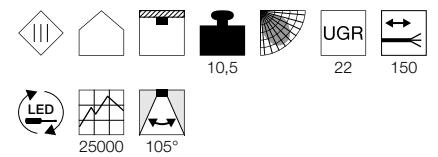
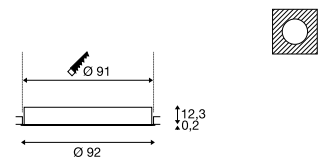
**Maßzeichnung****Hinweis**

Offenes Kabelend
Materialstärke Einbaufäche: 10-35 mm

Zubehörempfehlung

LED Treiber 60W | 1000mA |
inkl. Zugentlastung

Art. Nr. **1002422**

LED Treiber 50W | 1050mA | 1-10V/
DALI dimmbar | inkl. Zugentlastung

Art. Nr. **1002425**

LED Treiber 1000mA | 40W |
TRIAC dimmbar | inkl. Zugentlastung

Art. Nr. **1001115****Variante****Art. Nr.**

9550/10150lm | 3000/4000K | CRI>80

 weiß**1001908**

PANEL 60

EL, round

A-A++ Spektrum
A++-E

LED
INSIDE



135150 522



- LED Treiber wählbar

Produktangaben

1000mA/1050mA | 40W
Material: Aluminium

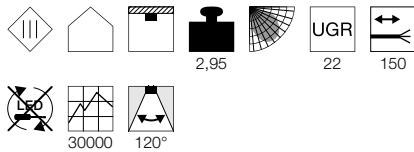

Maßzeichnung

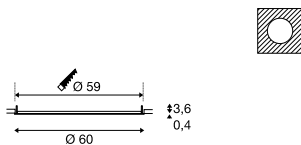

Hinweis

1) Standard nicht dimmbar 40W/1000mA (464170).
2) DALI dimmbar 50W/1050mA (464032).
3) TRIAC dimmbar 40W/1050mA (464804).
In unseren Kapitel Smart Home Lösungen finden Sie un erschiedliches VALETO® Zubehör passend zu Ihrer Treiber Auswahl.
Offenes Kabelend
Materialstärke Einbaufäche: 30 mm max

Zubehörempfehlung

■ LED Treiber 1000mA |
40W inkl. Zugentlastung
Art. Nr. **464170**



□ LED Treiber 350-1050mA |
50W | Dali 1-10V dimmbar
Art. Nr. **464032**



□ LED Treiber 1050mA |
40W Triac Phasenabschnitt dimmbar
Art. Nr. **464804**



Variante	Art. Nr.
2630lm 3000K CRI>80 □ weiß	158663
2930lm 4000K CRI>80 □ weiß	158664





1001250 523



1001251 523

VALETO® LED PANEL
595x595mm, UGR<19

A-A++ Spektrum A++-E

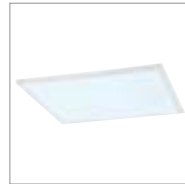

• Integrierbar in das VALETO® System

Produktangaben

100-240V ~50/60Hz | 1050mA
Systemleistung: 43W
Material: Aluminium / Acryl

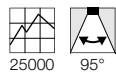

Maßzeichnung

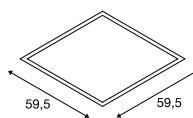

Hinweis

Fernsteuerbar und dimmbar mit Remote Control CCT/DIM [1002994] oder Gateway [1002411]

Ein Anwendungsvideo zu Dim to Warm finden Sie unter <http://bit.ly/dim-to-warm>



VALETO® LED PANEL
620x620mm, UGR<19

A-A++ Spektrum A++-E



• Integrierbar in das VALETO® System

Produktangaben

100-240V ~50/60Hz | 1050mA
Systemleistung: 43W
Material: Aluminium / Acryl

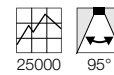
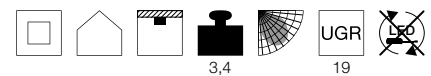

Maßzeichnung

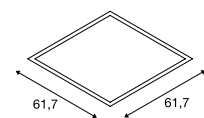

Hinweis

Fernsteuerbar und dimmbar mit Remote Control CCT/DIM [1002994] oder Gateway [1002411]

Ein Anwendungsvideo zu Dim to Warm finden Sie unter <http://bit.ly/dim-to-warm>



Variante	Art. Nr.
3200-3600lm 2700-6500K CRI>80 □ weiß	1001250

Variante	Art. Nr.
3200-3600lm 2700-6500K CRI>80 □ weiß	1001251

LED PANEL
600x600mm

A-A++ Spektrum A++-E

LED INSIDE

NEW VARIANT

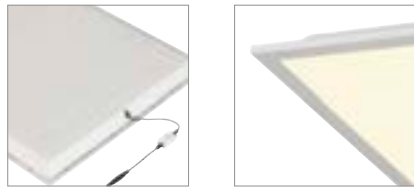

- Farbtemperatur wählbar

Produktangaben

700mA | 26W
Material: Aluminium / Polystrol (PS)
Produktmaße: H: 3 cm
Einbaumaße: T: 5 cm

Icons: Light distribution, UGR 22, 50, LED, 40000, 120°

Maßzeichnung

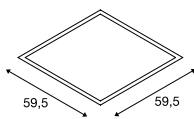

Hinweis

Offenes Kabelend

Zubehörempfehlung

LED Treiber 40W | 700mA | 1-10V/ DALI dimmbar | inkl. Zugentlastung
Art. Nr. 1002424

LED PANEL
620x620mm

A-A++ Spektrum A++-E

LED INSIDE

NEW VARIANT



- Farbtemperatur wählbar

Produktangaben

700mA | 26W
Material: Aluminium / Polystrol (PS)
Produktmaße: H: 3 cm
Einbaumaße: T: 5 cm

Icons: Light distribution, UGR 22, 50, LED, 40000, 120°

Maßzeichnung

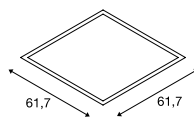

Hinweis

Offenes Kabelend

Zubehörempfehlung

LED Treiber 40W | 700mA | 1-10V/ DALI dimmbar | inkl. Zugentlastung
Art. Nr. 1002424

LED PANEL
620x620mm

A-A++ Spektrum A++-E

LED INSIDE

NEW VARIANT



- Premium LED mit CRI>90
- Bildschirmarbeitsplatzgerecht gemäß EN 12464-1
- UGR<19

Produktangaben

1050mA | 35W
Material: Aluminium / Polystrol (PS)
Produktmaße: H: 0,9 cm
Einbaumaße: T: 5 cm:

Icons: Light distribution, UGR 19, 150, LED, 50000, 120°

Maßzeichnung

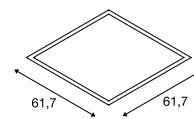

Hinweis

Offenes Kabelend

Zubehörempfehlung

LED Treiber 1050mA | 40W Triac Phasenabschnitt dimmbar
Art. Nr. 464804
 LED Treiber 50W | 1050mA | 1-10V/ DALI dimmbar | inkl. Zugentlastung
Art. Nr. 1002425

Variante	Art. Nr.
2600/2800lm 3000/4000K CRI>80 <input type="checkbox"/> weiß	1003071

Variante	Art. Nr.
2600/2800lm 3000/4000K CRI>80 <input type="checkbox"/> weiß	1003072

Variante	Art. Nr.
4000lm 4000K CRI>90 <input type="checkbox"/> weiß	1003074

LED PANEL
620x620mm



- Premium LED mit CRI>90
- Bildschirmarbeitsplatzgerecht gemäß EN 12464-1
- UGR<19

Produktangaben

1050mA | 35W
Material: Aluminium / Polystrol (PS)
Produktmaße: H: 0,9 cm
Einbaumaße: T: 5 cm

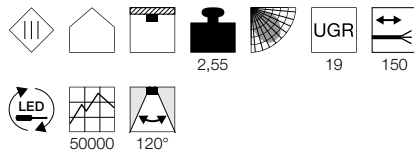

Maßzeichnung

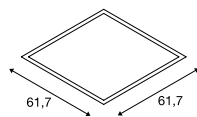

Hinweis

Offenes Kabelend

Zubehörempfehlung

- LED Treiber 1050mA | 40W Triac Phasenabschnitt dimmbar
Art. Nr. 464804
- LED Treiber 50W | 1050mA | 1-10V/ DALI dimmbar | inkl. Zugentlastung
Art. Nr. 1002425

Variante	Art. Nr.
4000lm 3000K CRI>90 <input type="checkbox"/> weiß	1003073

LED PANEL
600x600mm



- Premium LED mit CRI>90
- Bildschirmarbeitsplatzgerecht gemäß EN 12464-1
- UGR<19

Produktangaben

1050mA | 35W
Material: Aluminium / Polystrol (PS)
Produktmaße: H: 0,9 cm
Einbaumaße: T: 5 cm

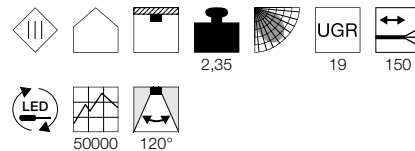

Maßzeichnung

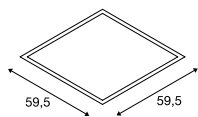

Hinweis

Offenes Kabelend

Zubehörempfehlung

- LED Treiber 1050mA | 40W Triac Phasenabschnitt dimmbar
Art. Nr. 464804
- LED Treiber 50W | 1050mA | 1-10V/ DALI dimmbar | inkl. Zugentlastung
Art. Nr. 1002425

Variante	Art. Nr.
4000lm 3000K CRI>90 <input type="checkbox"/> weiß	1003083
4000lm 4000K CRI>90 <input type="checkbox"/> weiß	1003084

LED PANEL
300x120mm



- Premium LED mit CRI>90
- Bildschirmarbeitsplatzgerecht gemäß EN 12464-1
- UGR<19

Produktangaben

900mA | 31W
Material: Aluminium / Polystrol (PS)
Produktmaße: L: 119,5 cm B: 29,5 cm H: 0,9 cm
Einbaumaße: T: 5 cm

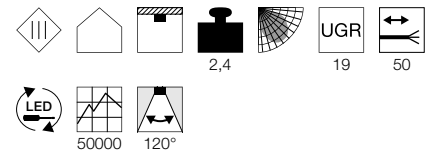

Maßzeichnung

Hinweis

Offenes Kabelend

Zubehörempfehlung

- LED Treiber 50W | 1050mA | 1-10V/ DALI dimmbar | inkl. Zugentlastung
Art. Nr. 1002425

Variante	Art. Nr.
3600lm 3000/4000K CRI>90 <input type="checkbox"/> weiß	1003075

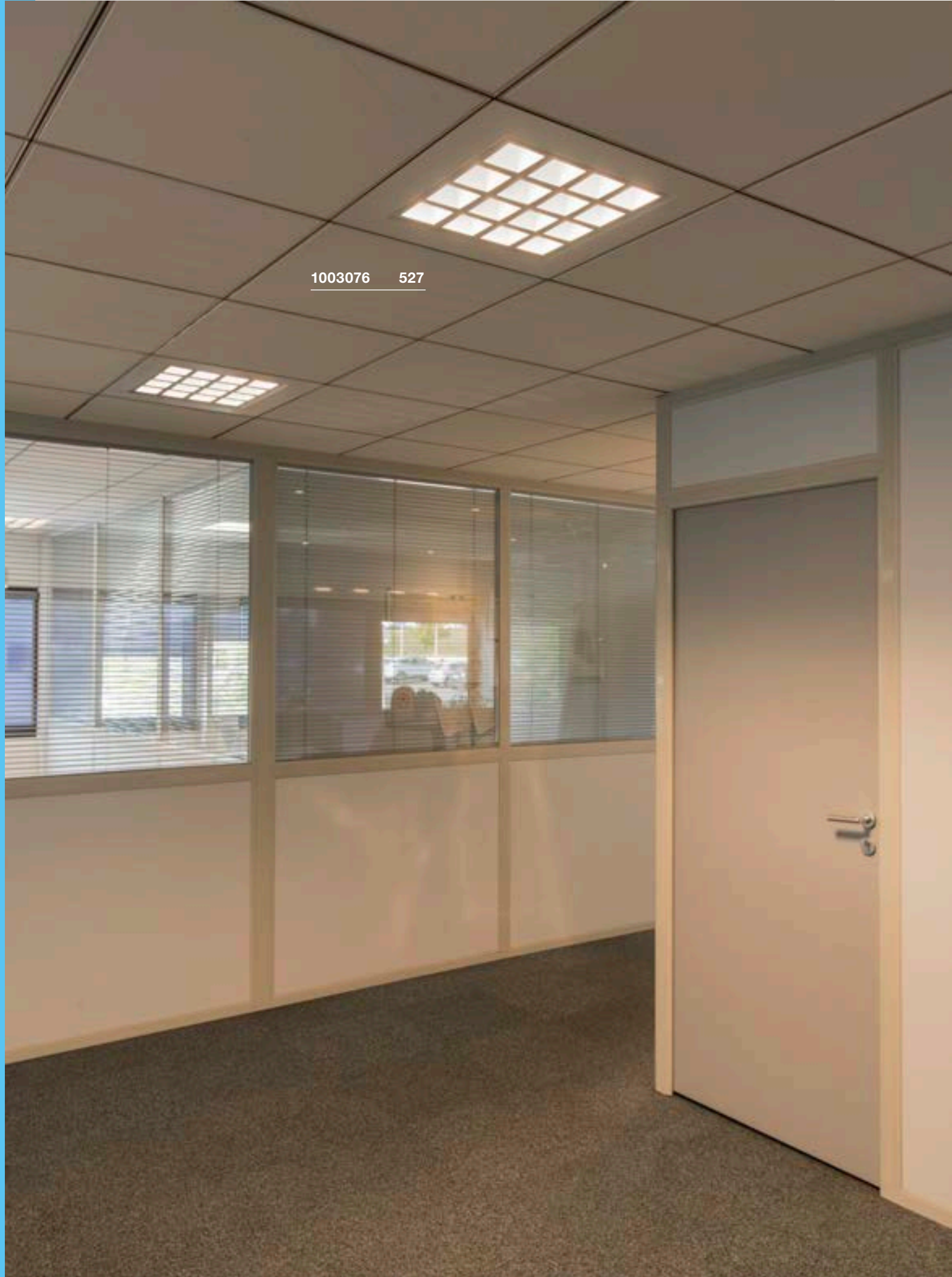

1003076 527

PAVANO
300x1200mm

A-A++ Spektrum A++-E



- Premium LED mit CRI>90
- Bildschirmarbeitsplatzgerecht gemäß EN 12464-1
- UGR<19

Produktangaben

700mA | 25W
Material: Stahl / Polycarbonat (PC)
Produktmaße: L: 119,5 cm B: 29,5 cm H: 3,6 cm
Einbaumaße: T: 5 cm

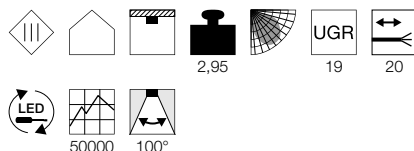

Hinweis

Offenes Kabelend

Zubehörempfehlung

□ LED Treiber 40W | 700mA | 1-10V/
DALI dimmbar | inkl. Zugentlastung
Art. Nr. 1002424



Variante	Art. Nr.
3300lm 3000K CRI>90	
□ weiß	1003080
3550lm 4000K CRI>90	
□ weiß	1003081

PAVANO
600x600mm

A-A++ Spektrum A++-E



- Premium LED mit CRI>90
- Bildschirmarbeitsplatzgerecht gemäß EN 12464-1
- UGR<19

Produktangaben

700mA | 25W
Material: Stahl / Polycarbonat (PC)
Produktmaße: L: 59,5 cm B: 59,5 cm H: 3,6 cm
Einbaumaße: T: 5 cm

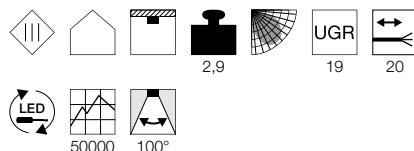

Hinweis

Offenes Kabelend

Zubehörempfehlung

□ LED Treiber 40W | 700mA | 1-10V/
DALI dimmbar | inkl. Zugentlastung
Art. Nr. 1002424



Variante	Art. Nr.
3300lm 3000K CRI>90	
□ weiß	1003076
3550lm 4000K CRI>90	
□ weiß	1003077

PAVANO
620x620mm

A-A++ Spektrum A++-E



- Premium LED mit CRI>90
- Bildschirmarbeitsplatzgerecht gemäß EN 12464-1
- UGR<19

Produktangaben

700mA | 25W
Material: Stahl / Polycarbonat (PC)
Produktmaße: L: 62 cm B: 62 cm H: 3,6 cm
Einbaumaße: T: 5 cm

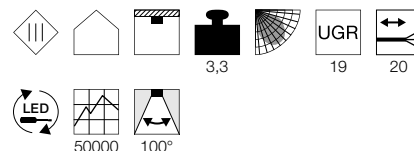

Hinweis

Offenes Kabelend

Zubehörempfehlung

□ LED Treiber 40W | 700mA | 1-10V/
DALI dimmbar | inkl. Zugentlastung
Art. Nr. 1002424



Variante	Art. Nr.
3300lm 3000K CRI>90	
□ weiß	1003078
3550lm 4000K CRI>90	
□ weiß	1003079

WEISEN DEN WEG.

MOBILE LEUCHTEN UND STANDLEUCHTEN.

Jetzt muss niemand mehr im Dunkeln tappen: Mobile Leuchten und Standleuchten sind ein beliebtes Gestaltungselement für Außenanlagen und bieten dabei Orientierung und Sicherheit. Die besondere Optik verdanken die Outdoor-Leuchten ihren hochwertigen Materialien, den modernen Formen und innovativen Technologien.

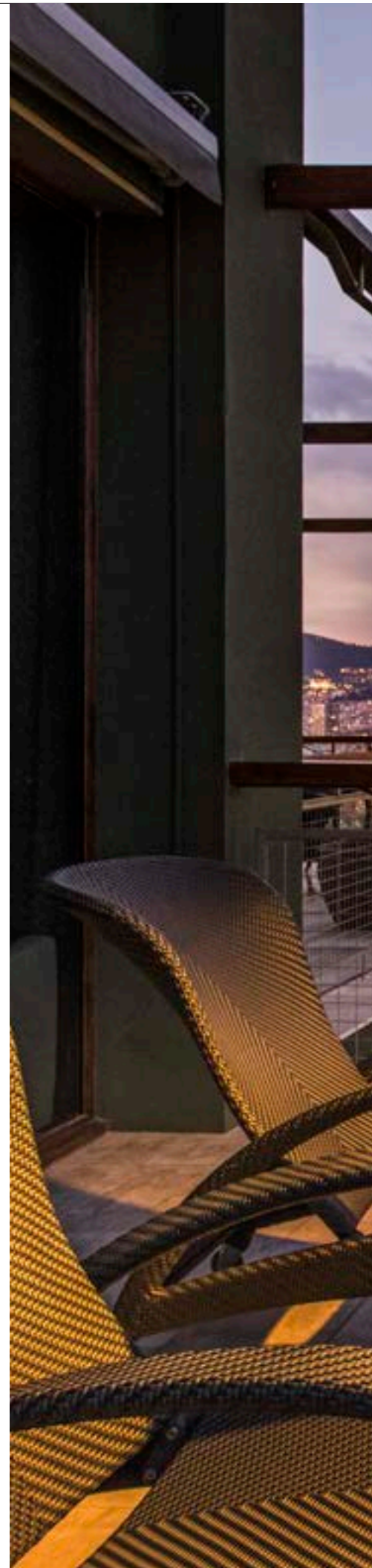

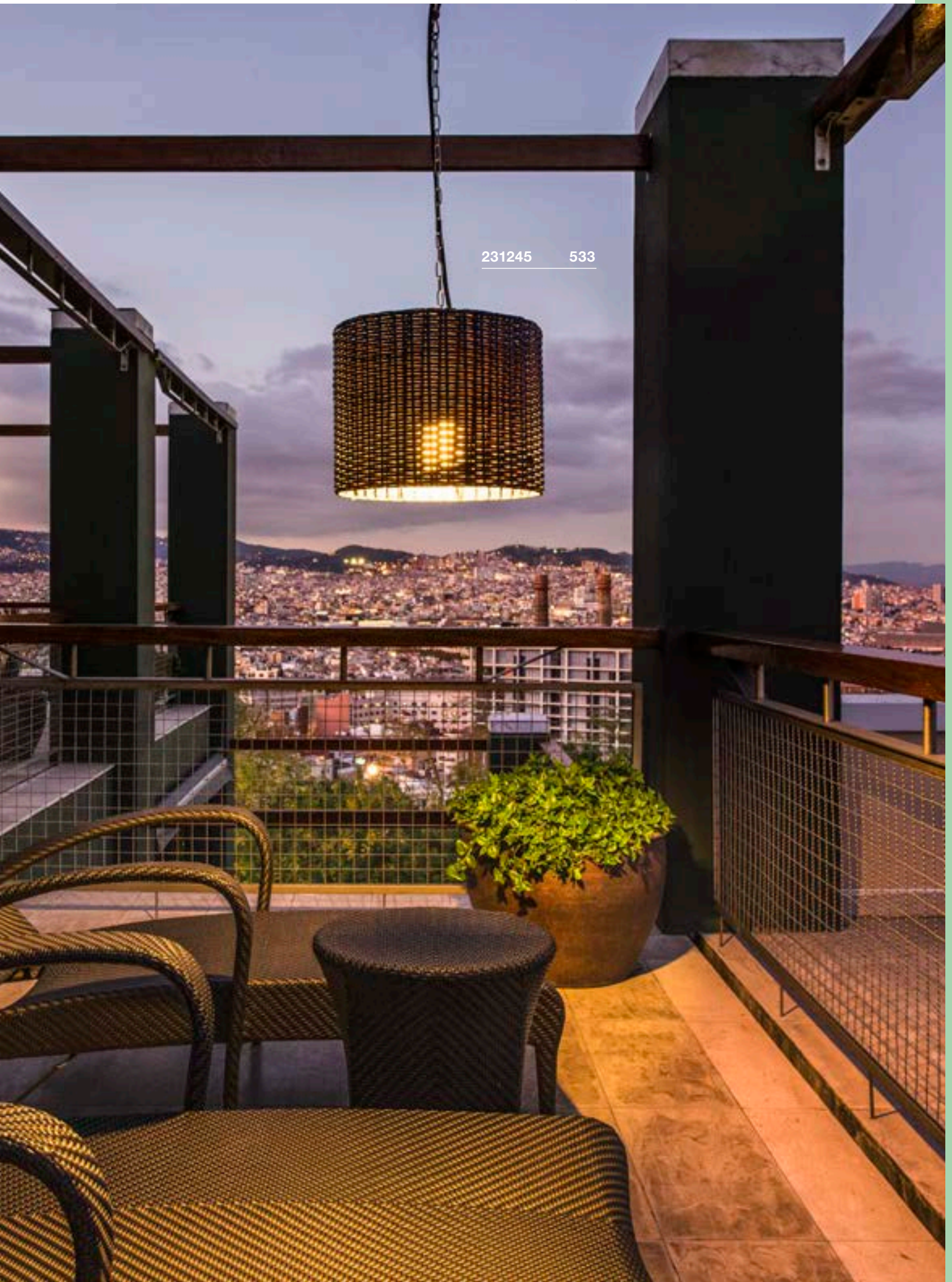

231245

533



1000822 550



MOBILE LEUCHTEN UND STANDLEUCHTEN



 Weitere Leuchten und Varianten finden Sie online unter www.slv.com

PHOTONIA
PD, E27



E-A++ Spektrum A++-E



MOLAT
PD, E27



E-A++ Spektrum A++-E



Produktangaben

220-240V ~50/60Hz
Material: Aluminium / Glas



Maßzeichnung

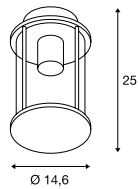

Hinweis

Kette für Abhängung inkl.

Zubehörempfehlung

■ Deckenrosette
Art. Nr. 1000398

Leuchtmittlempfehlung

LED E27 7,1W 330°
2700K 806lm EEK=A+
8kWh/1000h
Art. Nr. 1001756

LED E27 4,5W 280°
2200-2700K 500lm EEK=A++
5kWh/1000h
Art. Nr. 1002125

Leuchtmittelangaben

max. 60W
Ø: 9 cm max. L: 15 cm max.

Variante	Art. Nr.
E27	
■ anthrazit	232065

Produktangaben

230V ~50/60Hz
Material: Aluminium / Glas



Maßzeichnung

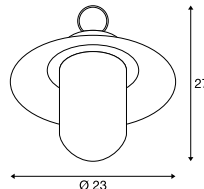

Hinweis

Kette für Abhängung inkl.

Zubehörempfehlung

■ Deckenrosette
Art. Nr. 1000398

Leuchtmittlempfehlung

E27 7,1W 330°
2700K 806lm EEK=A+
8kWh/1000h
Art. Nr. 560741

LED E27 4,5W 280°
2200-2700K 500lm EEK=A++
5kWh/1000h
Art. Nr. 1002125

Leuchtmittelangaben

max. 60W
Ø: 6,5 cm max. L: 14,5 cm max.

Variante	Art. Nr.
E27	
■ anthrazit	1000821



232065 532



232065 532

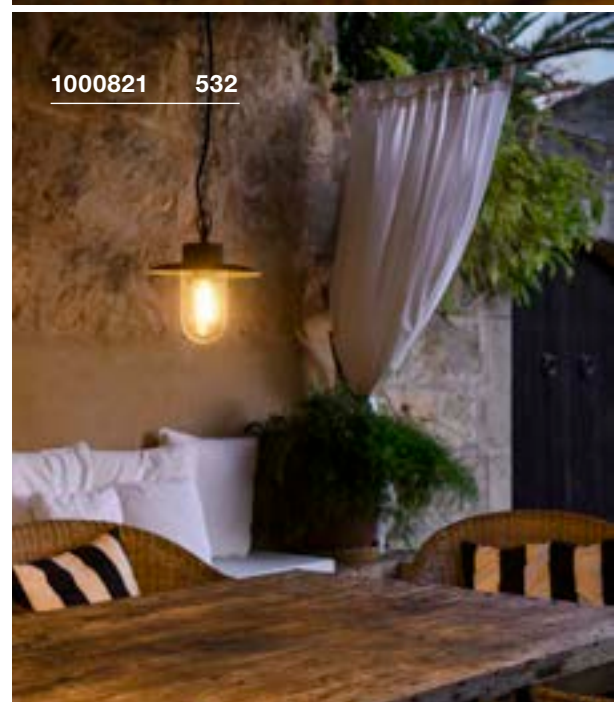

1000821 532

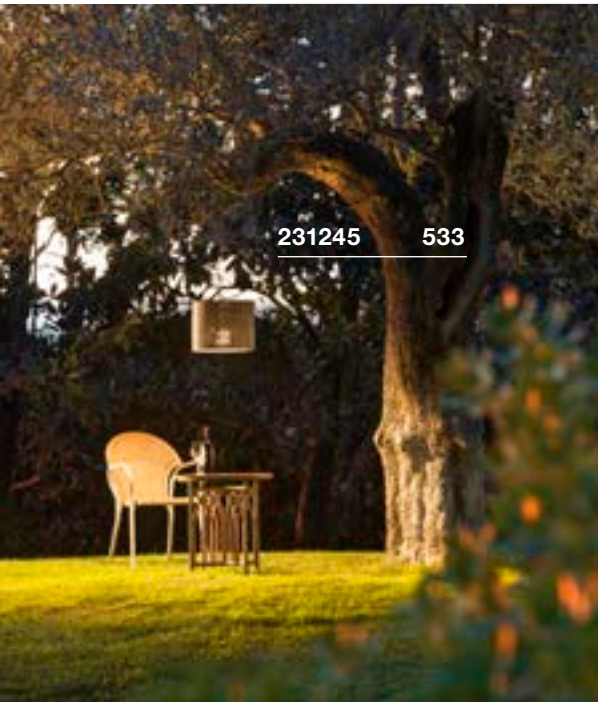

231245 533

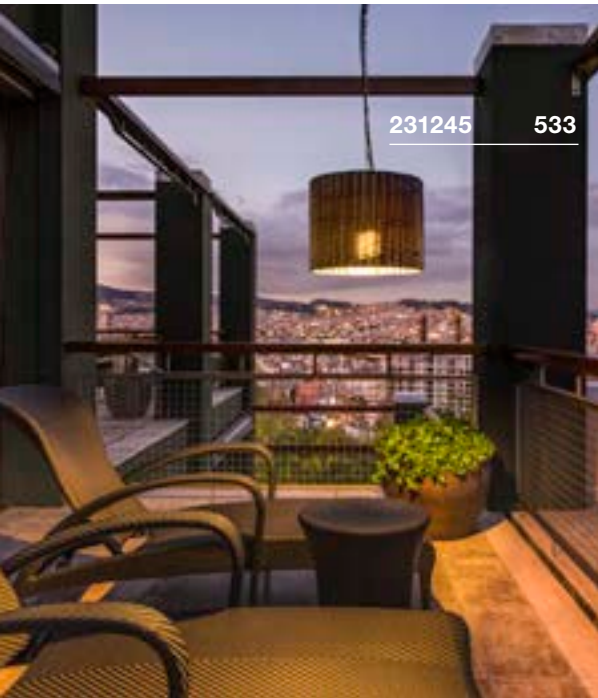

231245 533



228050 533

ADEGAN MANILA PD, E27



A-A++ Spektrum A++-E

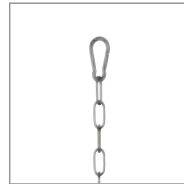

- Wetterbeständiges Geflecht

Produktangaben

230V ~50Hz
Material: Stahl / Polyethylen (PE)



Maßzeichnung

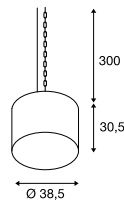

Hinweis

Kette und Karabinerhaken für Abhängung inkl. IP-Schutzkontaktstecker

Leuchtmittlempfehlung

E27 9W 240°
3000K 810lm EEK=A+
10kWh/1000h
Art. Nr. 1001031



LED E27 12W 240°
3000K 1055lm EEK=A+
12kWh/1000h
Art. Nr. 1001032



Leuchtmittelangaben

max. 24W
Ø: 4,8 cm max. L: 14 cm max.

Variante	Art. Nr.
E27	
■ anthrazit	231245

ROTOBALL 25/40 PD, E27



A-A++ Spektrum A++-E



- Harmonische Formgebung
- Gleichmäßige Lichtverteilung
- Zur dekorativen Beleuchtung und ästhetischen Akzentuierung im In- und Outdoor-Bereich

Produktangaben

230V ~50/60Hz
Material: Aluminium / Kunststoff

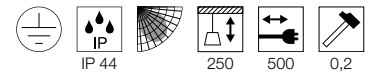

Maßzeichnung

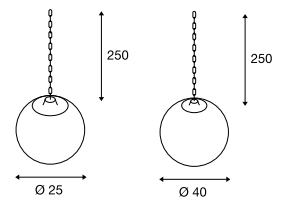

Hinweis

Kette und Karabinerhaken für Abhängung inkl. IP-Schutzkontaktstecker

Leuchtmittlempfehlung

LED E27 14,5W 200°
2700K 1521lm EEK=A+
15kWh/1000h
Art. Nr. 560422



LED E27 9,5W 240°
2200-6700K 806lm EEK=A+
10kWh/1000h
Art. Nr. 1001917



Leuchtmittelangaben

max. 24W

Variante	Art. Nr.
E27 Ø: 25 cm 1,25 kg	
■ grau / weiß	228050
E27 Ø: 40 cm 2,3 kg	
■ grau / weiß	228051

KIROCONE
TL, E27

E-A++ Spektrum A++-E

NEW



Produktangaben

230V ~50Hz
Material: Stahl / Polycarbonat (PC)

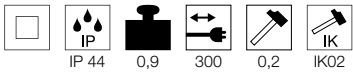

Maßzeichnung

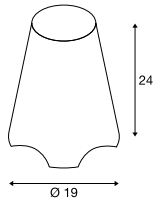

Hinweis

IP-Schutzkontaktstecker

Leuchtmittlempfehlung

LED E27 9W 240°
2700-6500K 806lm EEK=A+
9kWh/1000h
Art. Nr. 560402



LED E27 9,5W 240°
2200-6700K 806lm EEK=A+
10kWh/1000h
Art. Nr. 1001917



Leuchtmittelangaben

max. 60W
Ø: 9,5 cm max. L: 14,5 cm max.

Variante	Art. Nr.
E27 □ weiß	1001778



1001778 534



1001778 534



227550 537



1000400 537



1000400 537

KENGA 17 TL

A-A++ Spektrum A++-E



- Mobile kabellose Leuchte mit abnehmbarer Menükartenhalterung
- Durch den Taster stufenlos dimmbar
- Komfortables Laden per USB

Produktangaben

Batteriebetrieb 5V DC
Systemleistung: 3,2W
Material: Kunststoff / Holz
Dimmbar: Switch

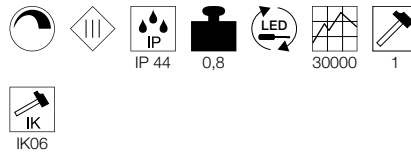

Maßzeichnung

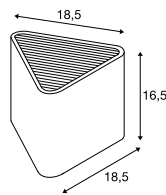

Hinweis

Die Funktionsdauer beträgt 5 Stunden bei voller Helligkeit und 10 Stunden bei halber Helligkeit. Das Produkt kann mit jedem beliebigen 5V USB Netzteil geladen werden. Der Bügel kann verstellt werden, um Speisekarten oder Servietten halten zu können.

Variante	Art. Nr.
200lm 3000K CRI>80 ■ matt weiß / matt braun	1000400

KENGA 45 FL, E27

E-A++ Spektrum A++-E



- Mobile Leuchte
- Leuchte und Sitzgelegenheit in Einem

Produktangaben

230V ~50/60Hz
Material: Polyethylen (PE) / Stahl

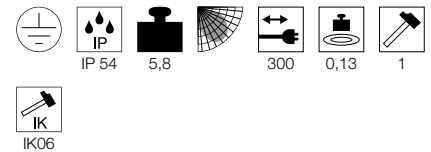

Maßzeichnung

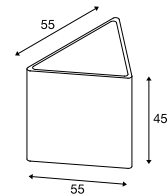

Hinweis

IP-Schutzkontaktstecker

Leuchtmittelpfehlung

E27 15W 240°
3000K 1521lm EEK=A+
15kWh/1000h
Art. Nr. 1001033

LED E27 7W 280°
2700K 790lm EEK=A++
7kWh/1000h
Art. Nr. 1002127

Leuchtmittelangaben

max. 24W
L: 22 cm max.

Variante	Art. Nr.
E27 □ weiß	227550

ROTOBALL 25/40/50
FL, E27



895

A-A++ Spektrum A++-E



- Harmonische Formgebung
- Gleichmäßige Lichtverteilung
- Zur dekorativen Beleuchtung und ästhetischen Akzentuierung im In- und Outdoor-Bereich

Produktangaben

230V ~50Hz
Material: Stahl / Polyethylen (PE)

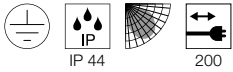

Maßzeichnung

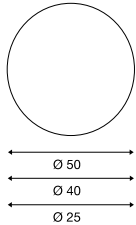

Hinweis

IP-Schutzkontaktstecker

Leuchtmittelpfehlung

LED E27 14,5W 200°
2700K 1521lm EEK=A+
15kWh/1000h



Art. Nr. 560422

LED E27 9W 240°
2700-6500K 806lm EEK=A+
9kWh/1000h



Art. Nr. 1001916

Leuchtmittelangaben

max. 24W
Ø: 9,5 cm max.

Variante	Art. Nr.
E27 Ø: 25 cm 1,05 kg □ weiß	227219
E27 Ø: 40 cm 2,2 kg □ weiß	227220
E27 Ø: 50 cm 3,12 kg □ weiß	227221





231395 539

ADEGAN MANILA
FL, E27A-A++ Spektrum
A++-E

FOLLOWER

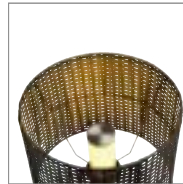

Produktangaben

230V ~50Hz
Material: Granit / Edelstahl

IP 44

16,4

250

Maßzeichnung

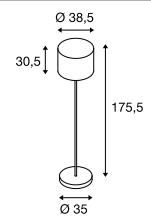

Hinweis

IP-Schutzkontaktstecker

Leuchtmittelangaben

max. 15W
 \varnothing : 4,8 cm max. L: 18 cm max.

Variante	Art. Nr.
E27 ■ edelstahl / anthrazit	1002494

ADEGAN FL, E27

A-A++ Spektrum
A++-E



- Mobile Leuchte
- Leuchtschirm: extrem UV-beständiges Polycarbonat
- Wohlfühllicht für jeden Gestaltungsstil

Produktangaben

220-240V ~50/60Hz
Material: Aluminium / Polycarbonat (PC)



Maßzeichnung

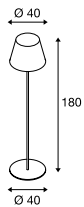

Hinweis

IP-Konturenstecker

Zubehörempfehlung

■ Erdspieß
Art. Nr. 228960



Leuchtmittlempfehlung

E27 15W 240°
3000K 1521lm EEK=A+
15kWh/1000h
Art. Nr. 1001033



Leuchtmittelangaben

max. 24W
Ø: 5,2 cm max.

Variante	Art. Nr.
E27	
□ weiß	228961
E27	
■ anthrazit / weiß	228965

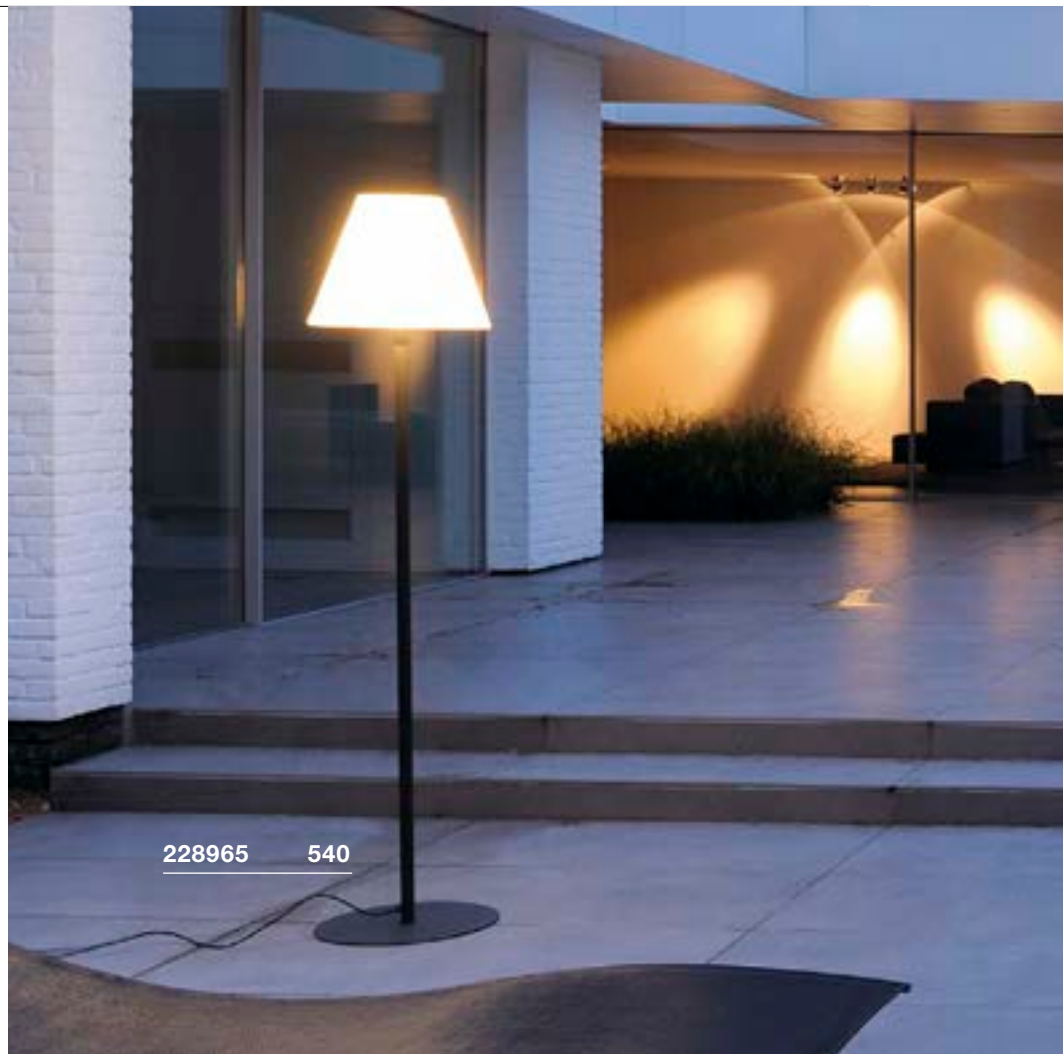

228965 540



228961 540



232095 541



231360 541

PHOTONIA
TL, E27



E-A++ Spektrum A++-E



- Extra langes Anschlusskabel mit IP Schutzkontaktstecker

Produktangaben

220-240V ~50/60Hz
Material: Aluminium / Glas



Maßzeichnung

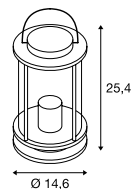

Hinweis

IP-Schutzkontaktstecker

Leuchtmittlempfehlung

E27 5W 330°
2000K 500lm EEK=A+
5kWh/1000h
Art. Nr. 560741



LED E27 4,5W 280°
2700K 530lm EEK=A++
5kWh/1000h
Art. Nr. 1002123



Leuchtmittelangaben

max. 60W
Ø: 9 cm max. L: 15 cm max.

Variante	Art. Nr.
E27	
■ anthrazit	232095

LISENNE
TL, E27



E-A++ Spektrum A++-E



- Basaltstein & Rauchglas
- Schalter an der Leuchtenunterseite

Produktangaben

230V ~50/60Hz
Material: Basalt / Glas

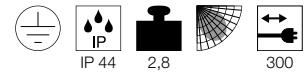

Maßzeichnung

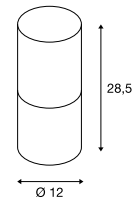

Hinweis

IP-Schutzkontaktstecker

Leuchtmittlempfehlung

LED E27 7,1W 330°
2700K 806lm EEK=A+
8kWh/1000h
Art. Nr. 1001756



Leuchtmittelangaben

max. 23W
Ø: 5,9 cm max. L: 15 cm max.

Variante	Art. Nr.
E27	
■ grau / braun	231360

CUBIX
FL, QPAR51E-A++ Spektrum
A++-E

- Mobile Leuchte

Produktangaben

230V ~50Hz
Material: Aluminium / Glas

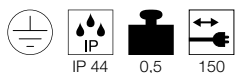

Maßzeichnung

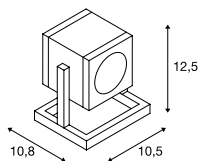

Hinweis

IP-Schutzkontaktstecker

Leuchtmittlempfehlung

LED GU10 5,5W 38°
2700K 400lm EEK=A+
6kWh/1000h
Art. Nr. 1001030



Leuchtmittelangaben

max. 25W QPAR51

Variante	Art. Nr.
GU10 QPAR51	
■ grau	132832
GU10 QPAR51	
■ anthrazit	132835

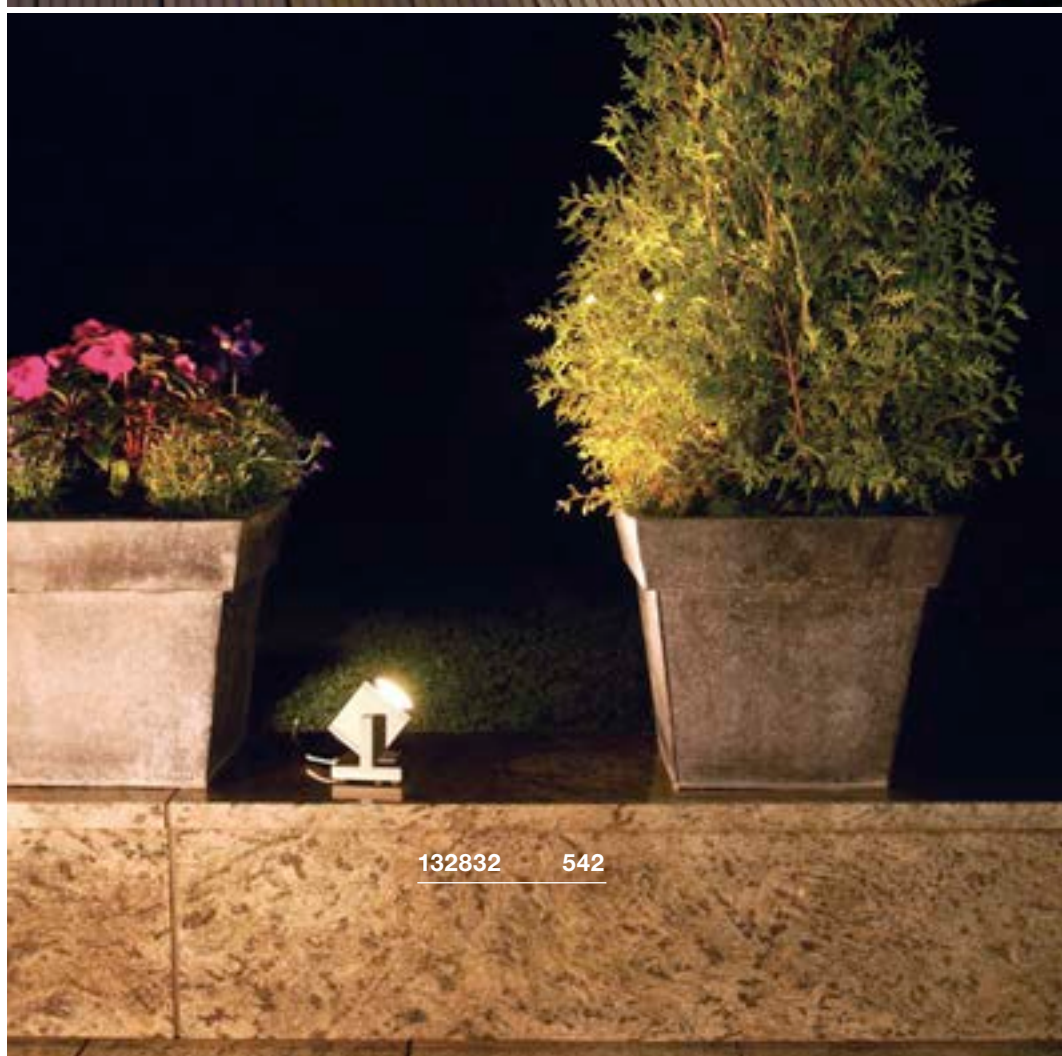



230435 543

CONE
FL, E27**E-A++** Spektrum
A++-E**Produktangaben**220-240V ~50/60Hz
Material: Aluminium / Glas

IP 54

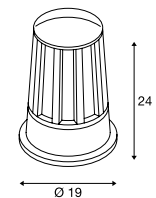

2,55

Maßzeichnung**Hinweis**

Materialstärke Einbaufäche: 20 mm

LeuchtmittlempfehlungLED E27 14,5W 200°
2700K 1521lm EEK=A+
15kWh/1000h

Art. Nr. 560422

LED E27 7W 280°
2700K 790lm EEK=A++
7kWh/1000h

Art. Nr. 1002124

**Leuchtmittelangaben**max. 100W
L: 15 cm max.

Variante	Art. Nr.
E27 ■ anthrazit	230435

RUSTY® CONE
FL, E14

A-A++ Spektrum
A++-E



- Stahl gerostet
- Jede Leuchte ist ein Unikat
- Kleiner Wegweiser für Einfahrt und Garten

Produktangaben

230V ~50Hz
Material: FeCSI-Stahl / Polycarbonat (PC)

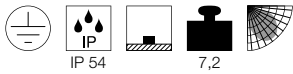

Maßzeichnung

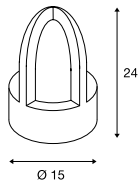

Leuchtmittlempfehlung

E14 3,4W 260°
3000K 250lm EEK=A+
4kWh/1000h
Art. Nr. 560362



LED E14 6,5W 280°
3000K 480lm EEK=A+
7kWh/1000h
Art. Nr. 560372



Leuchtmittelangaben

max. 40W C35
Ø: 4,8 cm max. L: 13,9 cm max.

Variante	Art. Nr.
E14 C35 ■ rost	229430

RUSTY® CONE 40/70
Pole, E27

A-A++ Spektrum
A++-E



- Stahl gerostet
- Jede Leuchte ist ein Unikat

Produktangaben

230V ~50Hz
Material: FeCSI-Stahl / Polycarbonat (PC)

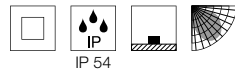

Maßzeichnung

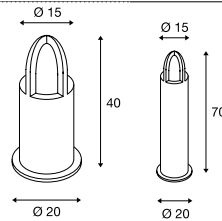

Zubehörempfehlung

- Verbindungsbox IP68, 3-polig
Art. Nr. 228730
- Erdspeiß
Art. Nr. 229423



Leuchtmittlempfehlung

E27 9W 240°
3000K 810lm EEK=A+
10kWh/1000h
Art. Nr. 1001031



Leuchtmittelangaben

max. 11W
Ø: 4,8 cm max. L: 13,9 cm max.

Variante	Art. Nr.
E27 H: 40 cm 12,2 kg ■ rost	229431
E27 H: 70 cm 18,8 kg ■ rost	229432

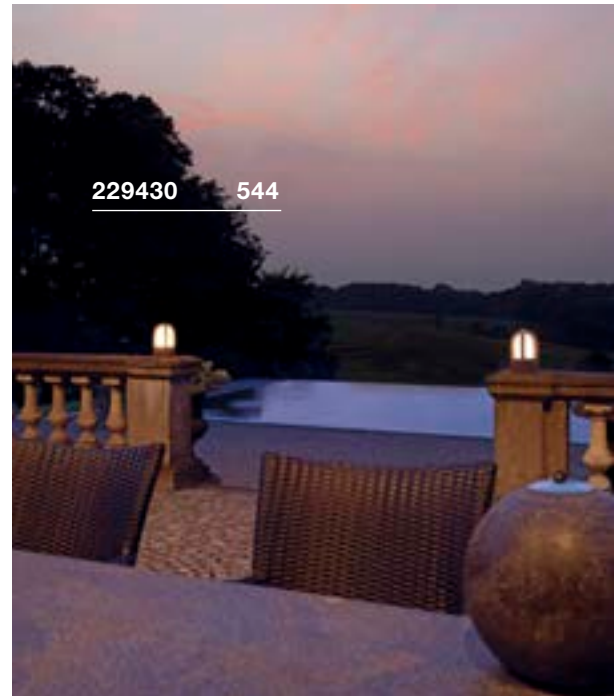
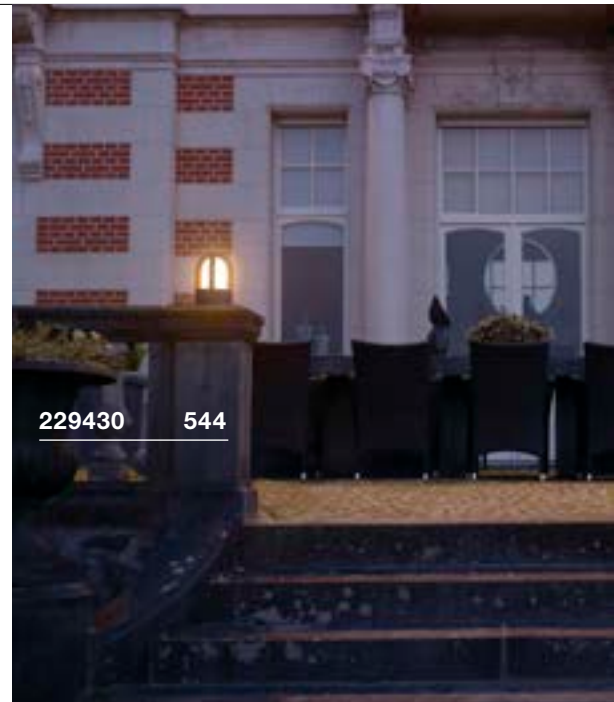



229021 545



229020 545

RUSTY® 40/70 Pole, E27

A-A++ Spektrum A++-E



- Stahl gerostet
- Jede Leuchte ist ein Unikat

Produktangaben

230V ~50Hz
Material: FeCSi-Stahl / Polycarbonat (PC)

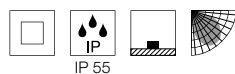

Maßzeichnung

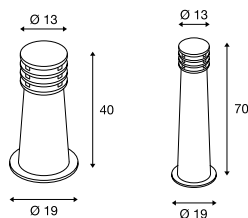

Zubehörempfehlung

■ Verbindungsbox IP68, 3-polig

Art. Nr. 228730

■ Erdspeiß

Art. Nr. 229022



Leuchtmittlempfehlung

E27 4,7W 360°
3000K 380lm EEK=A+
5kWh/1000h
Art. Nr. 551532

LED E27 9W 240°
3000K 810lm EEK=A+
10kWh/1000h
Art. Nr. 1001031



Leuchtmittelangaben

max. 11W
Ø: 4,8 cm max. L: 13,9 cm max.

Variante	Art. Nr.
E27 H: 40 cm 11 kg ■ rost	229020
E27 H: 70 cm 17,5 kg ■ rost	229021

RUSTY® 40/70 Pole

A-A++ Spektrum A++-E

LED INSIDE



- Stahl gerostet
- Jede Leuchte ist ein Unikat
- Hochvolt LED

Produktangaben

220-240V ~50/60Hz
Systemleistung: 8,6W
Material: FeCSi-Stahl / Polycarbonat (PC)

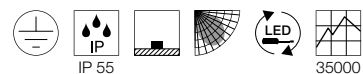

Maßzeichnung

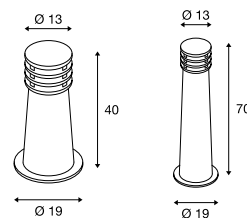

Hinweis

Offenes Kabelend

Zubehörempfehlung

■ Verbindungsbox IP68, 3-polig

Art. Nr. 228730

■ Erdspeiß

Art. Nr. 229022



Variante	Art. Nr.
70lm 3000K CRI>80 H: 40 cm 11 kg ■ rost	233407
70lm 3000K CRI>80 H: 70 cm 17,5 kg ■ rost	233417

LISENNE 40/70
Pole, E27



E-A++ Spektrum A++-E



• Basaltstein & Rauchglas

Produktangaben

230V ~50/60Hz
Material: Basalt / Glas

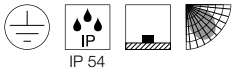

Maßzeichnung

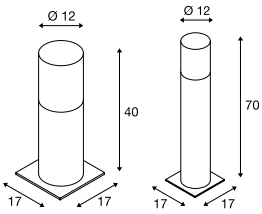

Zubehörempfehlung

■ Erdspieß
Art. Nr. 229422



Leuchtmittlempfehlung

LED E27 7,1W 330°
2700K 806lm EEK=A+
8kWh/1000h
Art. Nr. 1001756



Leuchtmittelangaben

max. 23W
Ø: 5,9 cm max. L: 15 cm max.

Variante	Art. Nr.
E27 H: 40 cm 5,65 kg ■ grau / braun	1000665
E27 H: 70 cm 12,4 kg ■ grau / braun	1000666



1000665 546



232075 547



230465 547

PHOTONIA
Pole, E27



E-A++ Spektrum A++-E



OTOS GLAS
Pole, E27

A-A++ Spektrum A++-E



Produktangaben

220-240V ~50/60Hz
Material: Aluminium / Glas

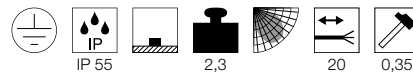

Maßzeichnung

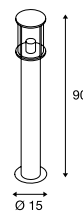

Hinweis

Offenes Kabelend

Zubehörempfehlung

- Betonanker
Art. Nr. 232085
- Verbindungsbox IP68, 3-polig
Art. Nr. 228730

Leuchtmittlempfehlung

E27 5W 330°
2000K 500lm EEK=A+
5kWh/1000h
Art. Nr. 560741

Leuchtmittelangaben

max. 60W
Ø: 9 cm max. L: 15 cm max.

Variante	Art. Nr.
E27	
■ anthrazit	232075

Produktangaben

230V ~50Hz
Material: Aluminium / Glas

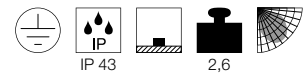

Maßzeichnung

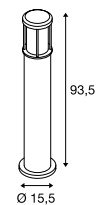

Zubehörempfehlung

- Schraubenset
Art. Nr. 228753
- Verbindungsbox IP68, 3-polig
Art. Nr. 228730

Leuchtmittlempfehlung

LED E27 14,5W 200°
2700K 1521lm EEK=A+
15kWh/1000h
Art. Nr. 560422

LED E27 6,8W 330°
2700K 806lm EEK=A+
7kWh/1000h
Art. Nr. 560762

Leuchtmittelangaben

max. 15W
Ø: 6,5 cm max. L: 14,5 cm max.

Variante	Art. Nr.
E27	
■ anthrazit	230465

GLOO PURE 27/44/70
Pole, E27



E-A++ Spektrum A++-E



ALPA CONE 100
Pole, E27

A-A++ Spektrum A+++-E

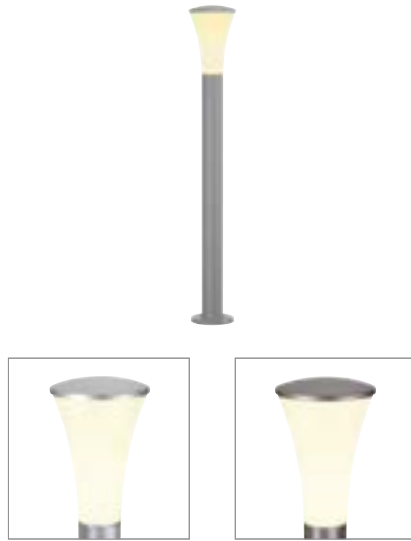

Produktangaben

230V ~50Hz
Material: Aluminium / Glas

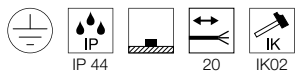

Maßzeichnung

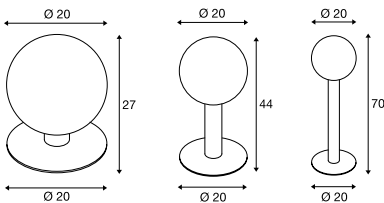

Hinweis

Offenes Kabelend

Zubehörempfehlung

■ Verbindungsbox IP68, 3-polig
Art. Nr. 228730

■ Erdspeiß
Art. Nr. 231234



Leuchtmittlempfehlung

E27 9W 240°
3000K 810lm EEK=A+
10kWh/1000h
Art. Nr. 1001031

LED E27 15W 240°
3000K 1521lm EEK=A+
15kWh/1000h
Art. Nr. 1001033



Leuchtmittelangaben

max. 23W
Ø: 4,8 cm max. L: 18 cm max.

Variante	Art. Nr.
E27 H: 27 cm 1,5 kg ■ anthrazit / matt transparent	1001999
E27 H: 44 cm 1,7 kg ■ anthrazit / matt transparent	1002000
E27 H: 70 cm 1,9 kg ■ anthrazit / matt transparent	1002001

Produktangaben

220-240V ~50/60Hz
Material: Aluminium / Polycarbonat (PC)

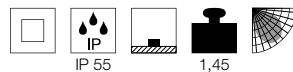

Maßzeichnung

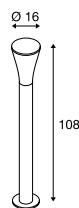

Hinweis

Offenes Kabelend

Zubehörempfehlung

■ Verbindungsbox IP68, 3-polig
Art. Nr. 228730

■ Erdspeiß
Art. Nr. 228722

■ Betonanker
Art. Nr. 228712



Leuchtmittlempfehlung

E27 9W 240°
3000K 810lm EEK=A+
10kWh/1000h
Art. Nr. 1001031

LED E27 12W 240°
3000K 1055lm EEK=A+
12kWh/1000h
Art. Nr. 1001032



Leuchtmittelangaben

max. 24W
Ø: 5,2 cm max. L: 17,5 cm max.

Variante	Art. Nr.
E27 ■ grau	228922
E27 ■ anthrazit	228925



1001999 548



228925 548

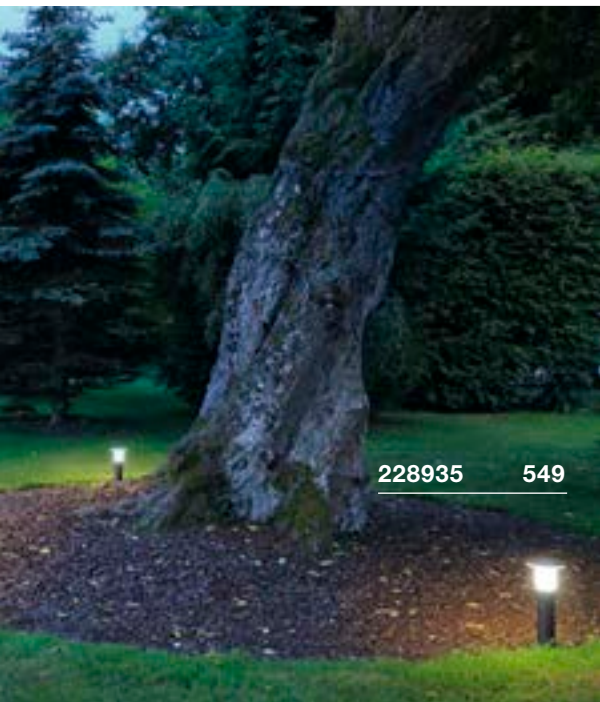

228935 549

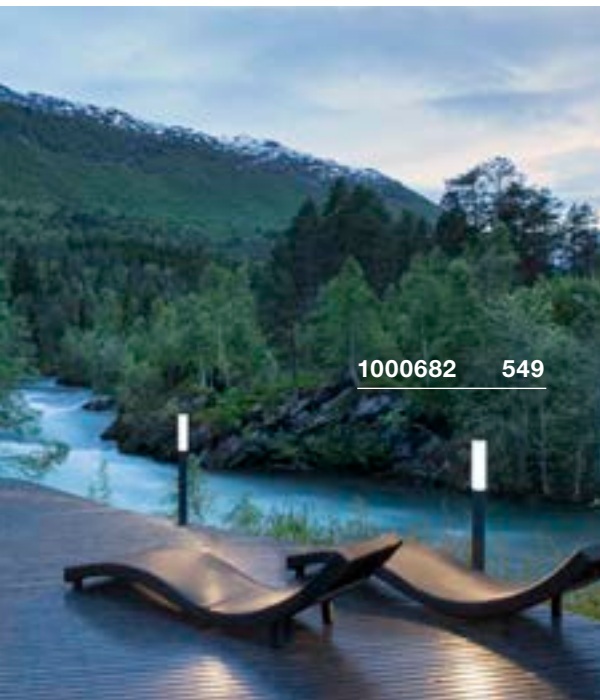

1000682 549

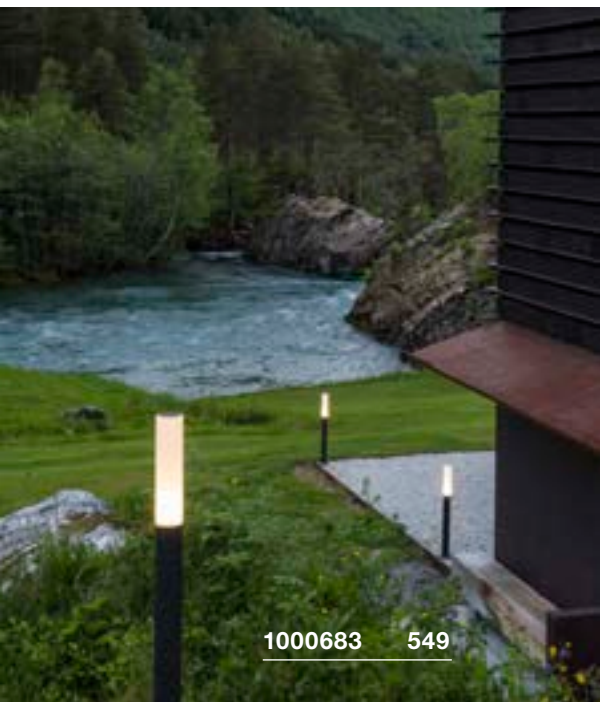

1000683 549

ALPA MUSHROOM 45/75
Pole, E27

A-A++ Spektrum A++-E



Produktangaben

220-240V ~50/60Hz
Material: Aluminium / Polycarbonat (PC)

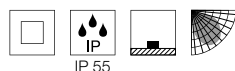

Maßzeichnung

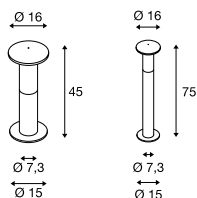

Hinweis

Offenes Kabelend

Zubehörempfehlung

■ Verbindungsbox IP68, 3-polig

Art. Nr. 228730

■ Erdspeiß

Art. Nr. 228722

Betonanker

Art. Nr. 228712

Leuchtmittlempfehlung

E27 15W 240°
3000K 1521lm EEK=A+
15kWh/1000h
Art. Nr. 1001033

Leuchtmittelangaben

max. 24W
Ø: 5,2 cm max. L: 16 cm max.

Variante	Art. Nr.
E27 H: 45 cm 0,9 kg ■ anthrazit	228935
E27 H: 75 cm 2 kg ■ anthrazit	228945

APONI 90/120
Pole, TRIAC

883

A-A++ Spektrum A++-E

LED INSIDE

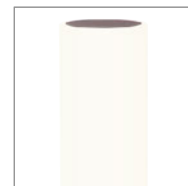

• Hochvolt LED

Produktangaben

220-240V ~50/60Hz
Systemleistung: 8W
Material: Aluminium
Dimmbar: Triac L

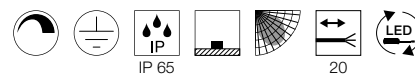

Maßzeichnung

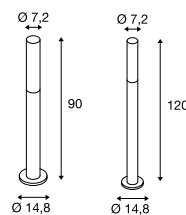

Hinweis

Offenes Kabelend

Zubehörempfehlung

■ Verbindungsbox IP68, 3-polig

Art. Nr. 228730

Variante	Art. Nr.
440lm 3000K CRI>80 H: 90 cm 1,466 kg ■ anthrazit	1000682
440lm 3000K CRI>80 H: 120 cm 1,845 kg ■ anthrazit	1000683

LIGHT PIPE 60/90/140
Pole, TRIAC



A-A++ Spektrum
A++-E

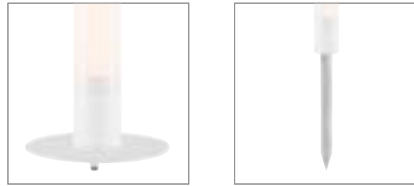

• Für innen und außen geeignet

Produktangaben

220-240V ~50/60Hz
Systemleistung: 11W
Material: Aluminium / Polymethylacrylat (PMMA)
Dimmbar: Triac C, Triac L

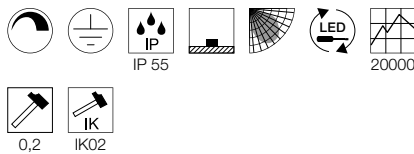

Maßzeichnung

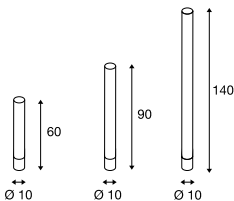

Hinweis

Die Leuchte wird ohne Montageplatte geliefert
Montageplatte indoor mit Fußschalter an der
Netzanschlussleitung
Montageplatte outdoor ohne Schalter,
mit IP44 Schutzkontaktstecker

Zubehörempfehlung

- Erdspeiß  Art. Nr. 234430
- Montageplatte outdoor  Art. Nr. 234431
- Montageplatte indoor  Art. Nr. 234441

Variante	Art. Nr.
630lm 2700K CRI>80 H: 60 cm 1,5 kg <input type="checkbox"/> weiß	234401
630lm 2700K CRI>80 H: 90 cm 1,71 kg <input type="checkbox"/> weiß	234411
630lm 2700K CRI>80 H: 140 cm 2,06 kg <input type="checkbox"/> weiß	234421

MOLAT
Pole, E27



E-A++ Spektrum
A++-E



Produktangaben

230V ~50/60Hz
Material: Aluminium / Glas



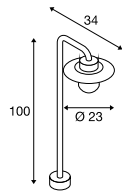

Maßzeichnung



Zubehörempfehlung

- Erdspeiß  Art. Nr. 230060

Leuchtmittlempfehlung

- E27 7,1W 330°
2700K 806lm EEK=A+
8kWh/1000h
Art. Nr. 560741 
- LED E27 9W 240°
3000K 810lm EEK=A+
10kWh/1000h
Art. Nr. 1001031 

Leuchtmittelangaben

max. 60W
Ø: 6,5 cm max. L: 14,5 cm max.

Variante	Art. Nr.
E27 <input checked="" type="checkbox"/> anthrazit	1000822



234411 550



1000822 550



228110 551



231602 551

TRUST 30/60 Pole



A-A++ Spektrum A++-E

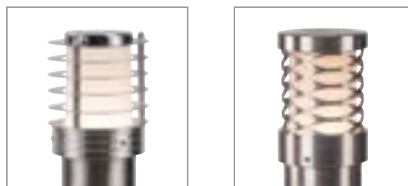

- Edelstahl 316
- Hochvolt LED
- Schlanker Wegweise für vielseitige Außengestaltungen

Produktangaben

220-240V ~50/60Hz
Systemleistung: 8,6W
Material: Edelstahl 316

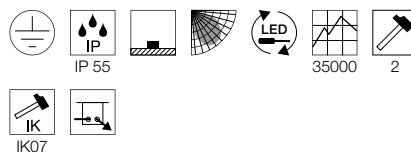

Maßzeichnung

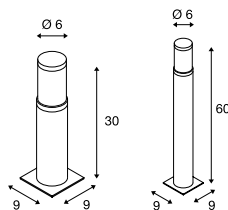

Zubehörempfehlung

- Verbindungsbox IP68, 3-polig
Art. Nr. 228730
- Erdspeiß
Art. Nr. 227922
- Raster spiralförmig
Art. Nr. 1000449
- Raster ringförmig
Art. Nr. 228130

Variante	Art. Nr.
400lm 3000K CRI>80 H: 30 cm 1,4 kg	228100
■ edelstahl	
400lm 3000K CRI>80 H: 60,5 cm 2,25 kg	228110
■ edelstahl	

BIG NAILS PLUS 50/80 Pole, E27



A-A+ Spektrum A++-E

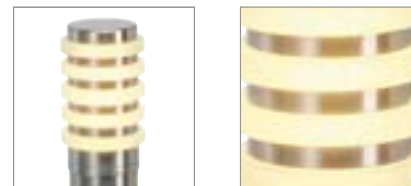

- Edelstahl 304

Produktangaben

230V ~50Hz
Material: Edelstahl 304 / Acryl

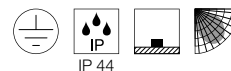

Maßzeichnung

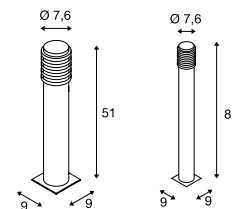

Zubehörempfehlung

- Verbindungsbox IP68, 3-polig
Art. Nr. 228730
- Erdspeiß
Art. Nr. 227922

Leuchtmittlempfehlung

- E27 12W 240°
3000K 1055lm EEK=A+
12kWh/1000h
Art. Nr. 1001032
- LED E27 15W 240°
3000K 1521lm EEK=A+
15kWh/1000h
Art. Nr. 1001033

Leuchtmittelangaben

max. 23W
Ø: 4,8 cm max. L: 14,8 cm max.

Variante	Art. Nr.
E27 H: 50 cm 1,13 kg	231602
■ edelstahl	
E27 H: 80 cm 1,54 kg	231612
■ edelstahl	

BIG NAILS 50/80
Pole



A-A++ Spektrum
A++-E



Produktangaben

230V ~50Hz
Systemleistung: 8,5W
Material: Edelstahl 316

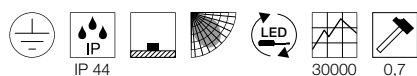

Maßzeichnung

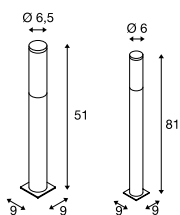

Zubehörempfehlung

■ Erdspeiß
Art. Nr. 227922



Variante	Art. Nr.
480lm 3000K CRI>80 H: 50 cm 0,9 kg ■ edelstahl	1001997
480lm 3000K CRI>80 H: 80 cm 1,235 kg ■ edelstahl	1001998

BIG NAILS 50/80
Pole, E27



A-A+ Spektrum
A++-E



- Edelstahl 304
- Schlanker Wegweiser für vielseitige Außengestaltungen

Produktangaben

230V ~50Hz
Material: Edelstahl 304 / Polycarbonat (PC)

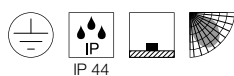

Maßzeichnung

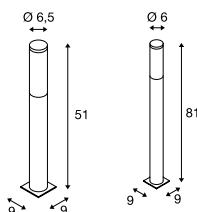

Zubehörempfehlung

■ Erdspeiß
Art. Nr. 227922



Leuchtmittlempfehlung

E27 4,7W 360°
3000K 380lm EEK=A+
5kWh/1000h
Art. Nr. 551532



LED E27 9W 240°
3000K 810lm EEK=A+
10kWh/1000h
Art. Nr. 1001031



Leuchtmittelangaben

max. 15W
Ø: 4,5 cm max. L: 17 cm max.

Variante	Art. Nr.
E27 H: 51 cm 1,1 kg ■ edelstahl	229162
E27 H: 81 cm 1,6 kg ■ edelstahl	229172



229162 552



229172 552





1001491 553



1001493 553

ROX ACRYL 30/60/90 Pole, TRIAC  895







A-A++ Spektrum A++-E 

LED INSIDE  





Produktangaben

220-240V ~50/60Hz
Systemleistung: 12W
Material: Edelstahl 316
Dimmbar: Triac C, Triac L

      

IP 44 30000

 

0,2 IK02

Maßzeichnung

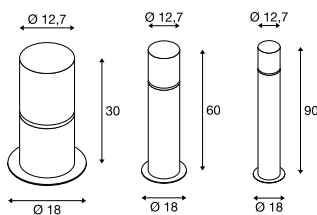

ROX ACRYL 30/60/90 Pole, E27  895

A-A++ Spektrum A++-E 









• Hochwertig gebürstete Oberfläche

Produktangaben

220-240V ~50/60Hz
Material: Edelstahl 304



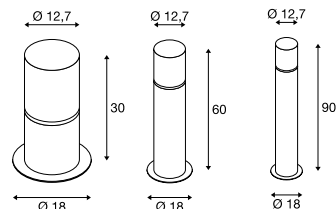

IP 44 0,2 IK02

Maßzeichnung



Zubehörempfehlung

-  T-Verbindebox
Art. Nr. 228726
-  Betonanker
Art. Nr. 1001494
-  Erdspeiß
Art. Nr. 231234



Leuchtmittlempfehlung



-  LED E27 9,1W 240°
2700K 760lm EEK=A+
10kWh/1000h
Art. Nr. 560402
-  LED E27 14,5W 200°
2700K 1521lm EEK=A+
15kWh/1000h
Art. Nr. 560422

Leuchtmittelangaben

max. 20W
Ø: 6 cm max. L: 15 cm max.

Zubehörempfehlung

-  T-Verbindebox
Art. Nr. 228726
-  Betonanker
Art. Nr. 1001494
-  Erdspeiß
Art. Nr. 231234

Variante	Art. Nr.
690lm 3000K CRI>80 H: 30 cm 1,55 kg	 edelstahl 1001491
690lm 3000K CRI>80 H: 60 cm 2,55 kg	 edelstahl 1001492
690lm 3000K CRI>80 H: 90 cm 3,45 kg	 edelstahl 1001493

Variante	Art. Nr.
E27 H: 30 cm 1,1 kg	 edelstahl 1001488
E27 H: 60 cm 2,1 kg	 edelstahl 1001489
E27 H: 90 cm 3 kg	 edelstahl 1001490

VAP SLIM 30/60/90
Pole, E27

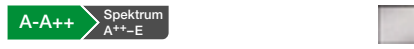

- Edelstahl 304
- Schlanker Wegweiser für vielseitige Außengestaltungen

Produktangaben

230V ~50Hz
Material: Edelstahl 304



Maßzeichnung

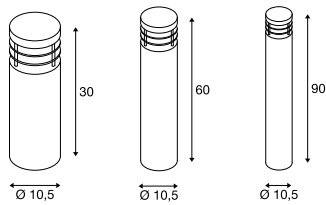

Zubehörempfehlung

- Erdspeiß
Art. Nr. 230060
- Betonanker
Art. Nr. 230061

Leuchtmittlempfehlung

- E27 9W 240°
3000K 810lm EEK=A+
10kWh/1000h
Art. Nr. 1001031

Leuchtmittelangaben

max. 20W
Ø: 5 cm max. L: 12,6 cm max.

Variante	Art. Nr.
E27 H: 30 cm 1,5 kg ■ matt edelstahl	230063
E27 H: 60 cm 2,5 kg ■ matt edelstahl	230066
E27 H: 90 cm 3,4 kg ■ matt edelstahl	230069

VAP 40/70/100
Pole, E27



- Edelstahl 304

Produktangaben

230V ~50Hz
Material: Edelstahl 304

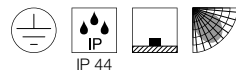

Maßzeichnung

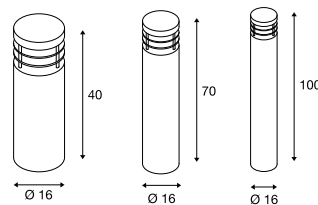

Zubehörempfehlung

- Verbindungsbox IP68, 3-polig
Art. Nr. 228730
- Betonanker
Art. Nr. 229059

Leuchtmittlempfehlung

- E27 9W 240°
3000K 810lm EEK=A+
10kWh/1000h
Art. Nr. 1001031

Leuchtmittelangaben

max. 23W
Ø: 5,2 cm max. L: 12,1 cm max.

Variante	Art. Nr.
E27 H: 40 cm 4,4 kg ■ edelstahl	229054
E27 H: 70 cm 6 kg ■ edelstahl	229057
E27 H: 100 cm 7,6 kg ■ edelstahl	229050



229054 554



230066 554



231595 555

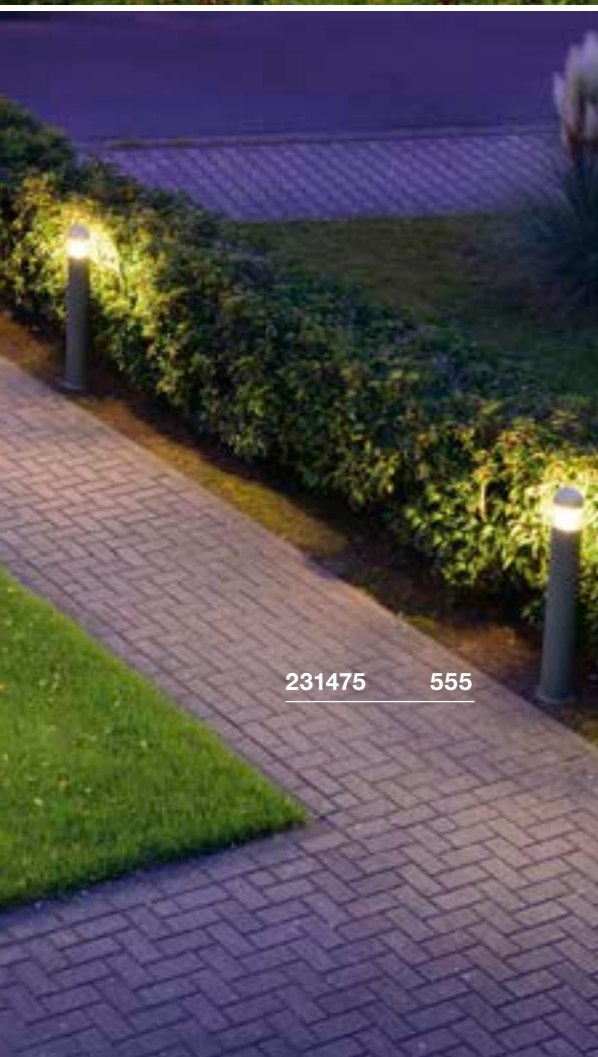

231475 555

F-POL
Pole, E27



A-A++ Spektrum A++-E



C-POL
Pole, E27



A-A++ Spektrum A++-E

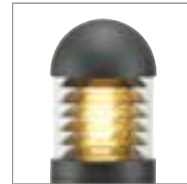

Produktangaben

230V ~50Hz
Material: Aluminium / Polycarbonat (PC)

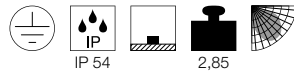

Maßzeichnung

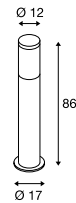

Produktangaben

230V ~50Hz
Material: Aluminium / Polycarbonat (PC)

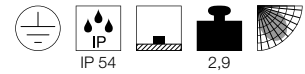

Maßzeichnung

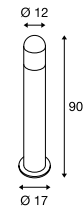

Zubehörempfehlung

■ Verbindungsbox IP68, 3-polig
Art. Nr. 228730



Leuchtmittlempfehlung

E27 15W 240°
3000K 1521lm EEK=A+
15kWh/1000h
Art. Nr. 1001033



Leuchtmittelangaben

max. 20W
Ø: 5 cm max. L: 14,8 cm max.

Variante	Art. Nr.
E27 ■ anthrazit	231595

Zubehörempfehlung

■ Verbindungsbox IP68, 3-polig
Art. Nr. 228730



Leuchtmittlempfehlung

E27 9W 240°
3000K 810lm EEK=A+
10kWh/1000h
Art. Nr. 1001031



Leuchtmittelangaben

max. 24W
Ø: 5,2 cm max. L: 17,3 cm max.

Variante	Art. Nr.
E27 ■ anthrazit	231475

POLE PARC
90/150/200
Pole



A-A++ Spektrum
A+-E



- Lichttechnisches System zur gezielten Bodenflutung
- Gleichmäßige rotationssymmetrische Lichtverteilung
- Modernes Design für dezente, blendfreie Lichtgebung

Produktangaben

100-240V ~50/60Hz | 1450mA
Material: Aluminium / Kunststoff

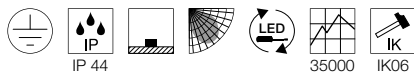

Maßzeichnung

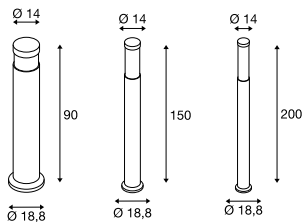

Zubehörempfehlung

■ Verbindungsbox IP68, 3-polig
Art. Nr. 228730



Variante	Art. Nr.
1000lm 3000K CRI>80 90 cm 5,2 kg 145mA 21W ■ anthrazit	1000760
1800lm 3000K CRI>80 150 cm 8,3 kg 840mA 33W ■ anthrazit	1000761
2600lm 3000K CRI>80 200 cm 11,5 kg 1430mA 50W ■ anthrazit	1000762

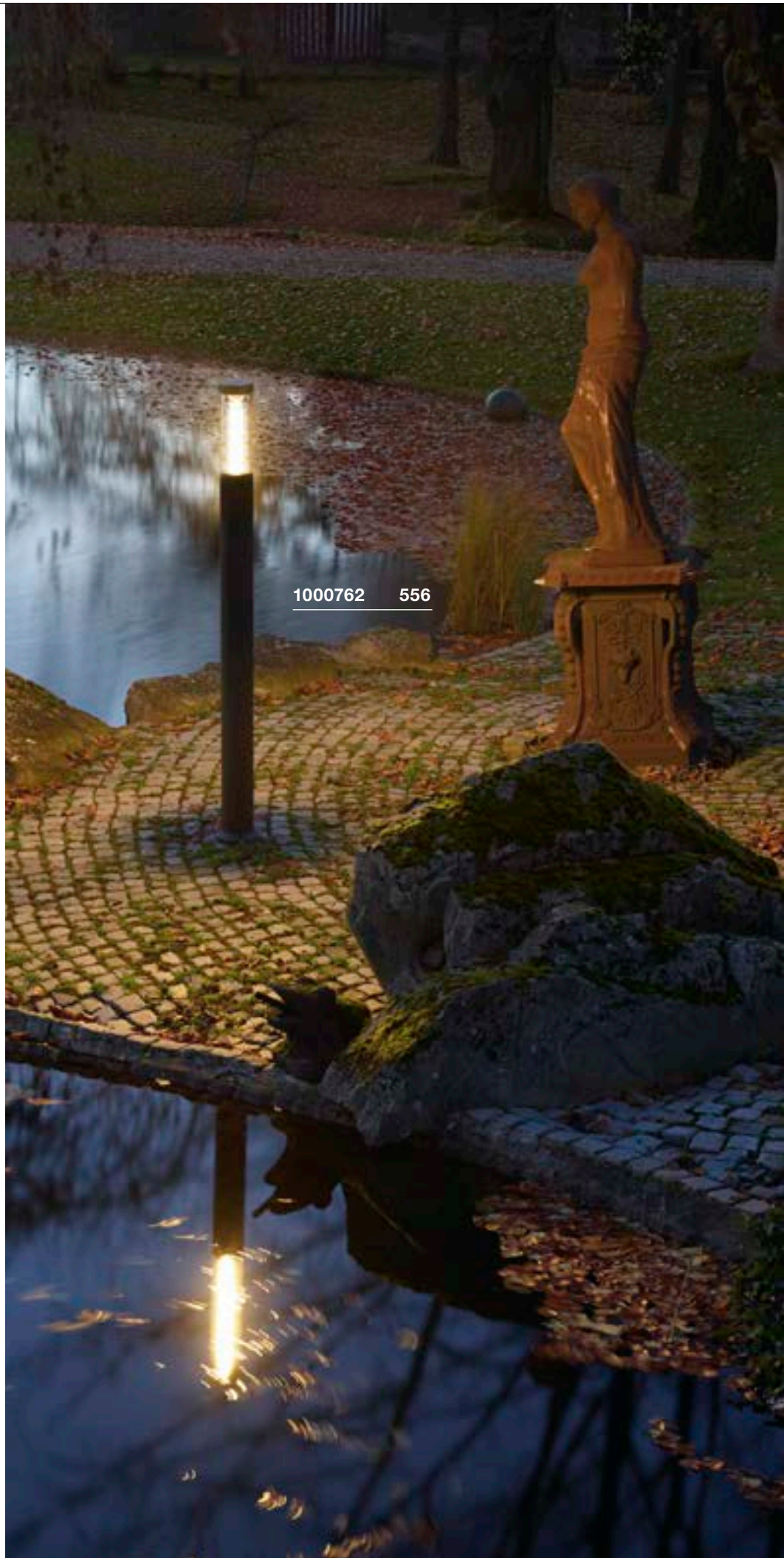

1000762 556



GRAFIT 30/60
Pole, E27



A-A++ Spektrum
A++-E



Produktangaben

230V ~50Hz
Material: Aluminium / Kunststoff

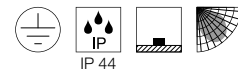

Maßzeichnung

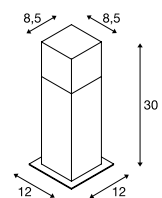

Zubehörempfehlung

- Schraubenset
Art. Nr. 228752
- Erdspeiß
Art. Nr. 231230



Leuchtmittelpfehlung

LED E27 9,1W 240°
2700K 760lm EEK=A+
10kWh/1000h
Art. Nr. 560402



231225 557

Leuchtmittelangaben

max. 11W
Ø: 6 cm max. L: 11,5 cm max.

Variante	Art. Nr.
E27 H: 30 cm 0,8 kg ■ anthrazit	231215
E27 H: 60 cm 1,4 kg ■ anthrazit	231225

LOGS 40/70
Pole



A-A++ Spektrum
A++-E



Produktangaben

100-240V ~50/60Hz | 500mA
Systemleistung: 8W
Material: Aluminium

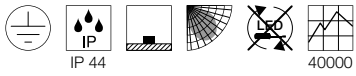

Maßzeichnung

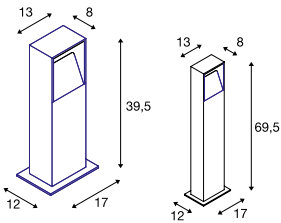

Zubehörempfehlung

- Verbindungsbox IP68, 3-polig
Art. Nr. 228730
- Erdspeiß
Art. Nr. 231230
- Schraubenset
Art. Nr. 228754
- Betonanker
Art. Nr. 232119



Variante	Art. Nr.
420lm 3000K CRI>80 H: 39,5 cm 2 kg ■ anthrazit	232115
420lm 3000K CRI>80 H: 69,5 cm 2,8 kg ■ anthrazit	232125



232125 558

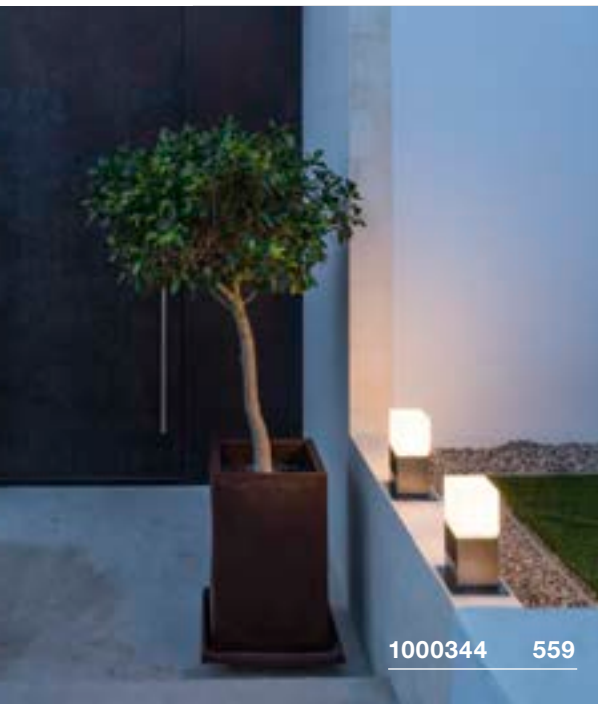

1000344 559



1000346 559



1000416 559

SQUARE POLE
30/60/90
Pole, TRIAC



A-A++ Spektrum A++-E



- Leuchte aus Edelstahl 304
- Modernes Design für wegweisendes Licht
- Diffuse Lichtverteilung zur Aufhellung der Umgebung

Produktangaben

220-240V ~50/60Hz
Material: Edelstahl 304

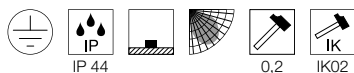

Maßzeichnung

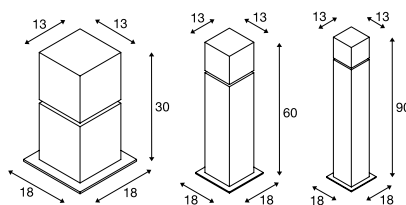

Zubehörempfehlung

- Verbindungsbox IP68, 3-polig
Art. Nr. 228730
- Betonanker
Art. Nr. 1000343
- Erdspieß
Art. Nr. 231234

Leuchtmittlempfehlung

- LED E27 9,1W 240°
2700K 760lm EEK=A+
10kWh/1000h
Art. Nr. 560402
- LED E27 9W 240°
2700-6500K 806lm EEK=A+
9kWh/1000h
Art. Nr. 1001916

Leuchtmittelangaben

max. 20W
Ø: 6 cm max. L: 15 cm max.

Variante	Art. Nr.
E27 H: 30 cm 1,2 kg ■ edelstahl	1000344
E27 H: 60 cm 2,5 kg ■ edelstahl	1000345
E27 H: 90 cm 3,9 kg ■ edelstahl	1000346

SQUARE POLE
30/60/90
Pole, TRIAC



A-A++ Spektrum A++-E

LED INSIDE



- Leuchte aus hochwertigem 316 Edelstahl
- Modernes Design für wegweisendes Licht
- Diffuse Lichtverteilung zur Aufhellung der Umgebung

Produktangaben

220-240V ~50/60Hz
Systemleistung: 12W
Material: Edelstahl 316
Dimmbar: Triac C, Triac L



Maßzeichnung

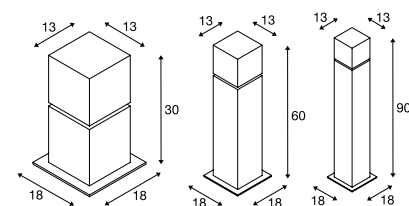

Zubehörempfehlung

- Verbindungsbox IP68, 3-polig
Art. Nr. 228730
- Betonanker
Art. Nr. 1000343
- Erdspieß
Art. Nr. 231234

Variante	Art. Nr.
760lm 3000K CRI>80 H: 30 cm 2 kg ■ edelstahl	1000416
760lm 3000K CRI>80 H: 60 cm 3,4 kg ■ edelstahl	1000417
760lm 3000K CRI>80 H: 90 cm 4,7 kg ■ edelstahl	1000418

RUSTY® 40/70
Pole, E27



- Stahl gerostet
- Jede Leuchte ist ein Unikat

Produktangaben

230V ~50Hz
Material: FeCSi-Stahl / Polycarbonat (PC)

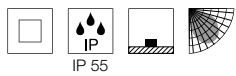

Maßzeichnung

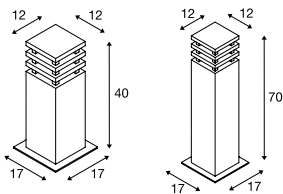

Zubehörempfehlung

- Verbindungsbox IP68, 3-polig
Art. Nr. **228730**
- Erdspieß
Art. Nr. **229422**



Leuchtmittlempfehlung

- E27 4,7W 360°
3000K 380lm EEK=A+
5kWh/1000h
Art. Nr. **551532**
- LED E27 9W 240°
3000K 810lm EEK=A+
10kWh/1000h
Art. Nr. **1001031**



Leuchtmittelangaben

max. 11W
Ø: 4,8 cm max. L: 13,9 cm max.

Variante	Art. Nr.
E27 H: 40 cm 11 kg ■ rost	229420
E27 H: 71 cm 22 kg ■ rost	229421

RUSTY® 40/70
Pole



- Stahl gerostet
- Jede Leuchte ist ein Unikat
- Hochvolt LED

Produktangaben

220-240V ~50/60Hz
Systemleistung: 8,6W
Material: FeCSi-Stahl / Polycarbonat (PC)

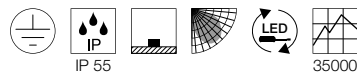

Maßzeichnung

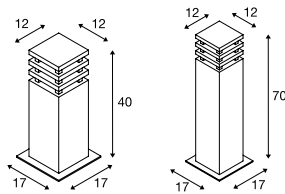

Hinweis

Offenes Kabelend

Zubehörempfehlung

- Verbindungsbox IP68, 3-polig
Art. Nr. **228730**
- Erdspieß
Art. Nr. **229422**



Variante	Art. Nr.
90lm 3000K CRI>80 H: 40 cm 11 kg ■ rost	233427
90lm 3000K CRI>80 H: 71 cm 22 kg ■ rost	233437

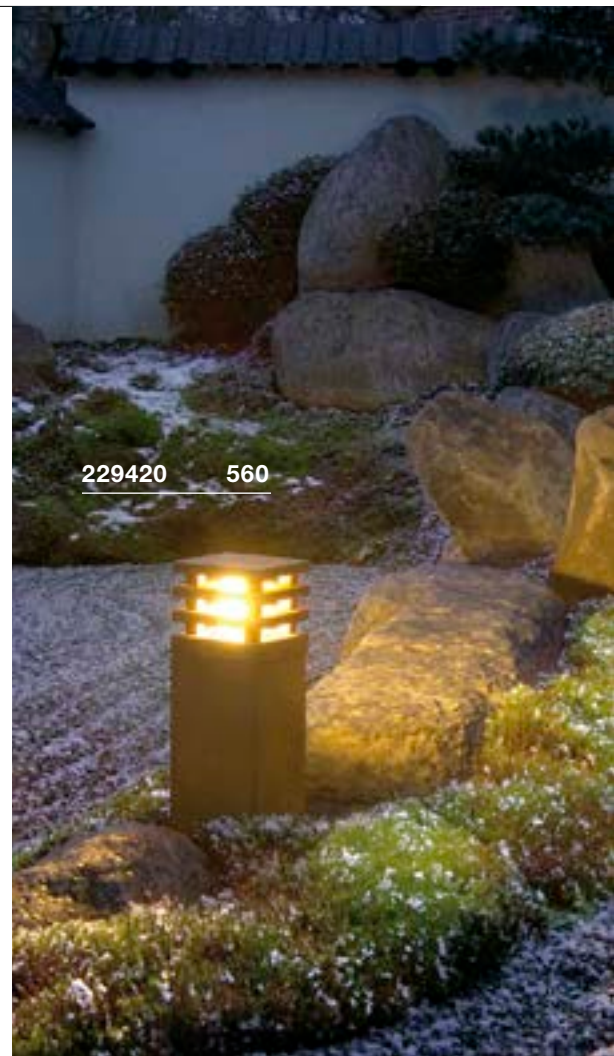



231410 561

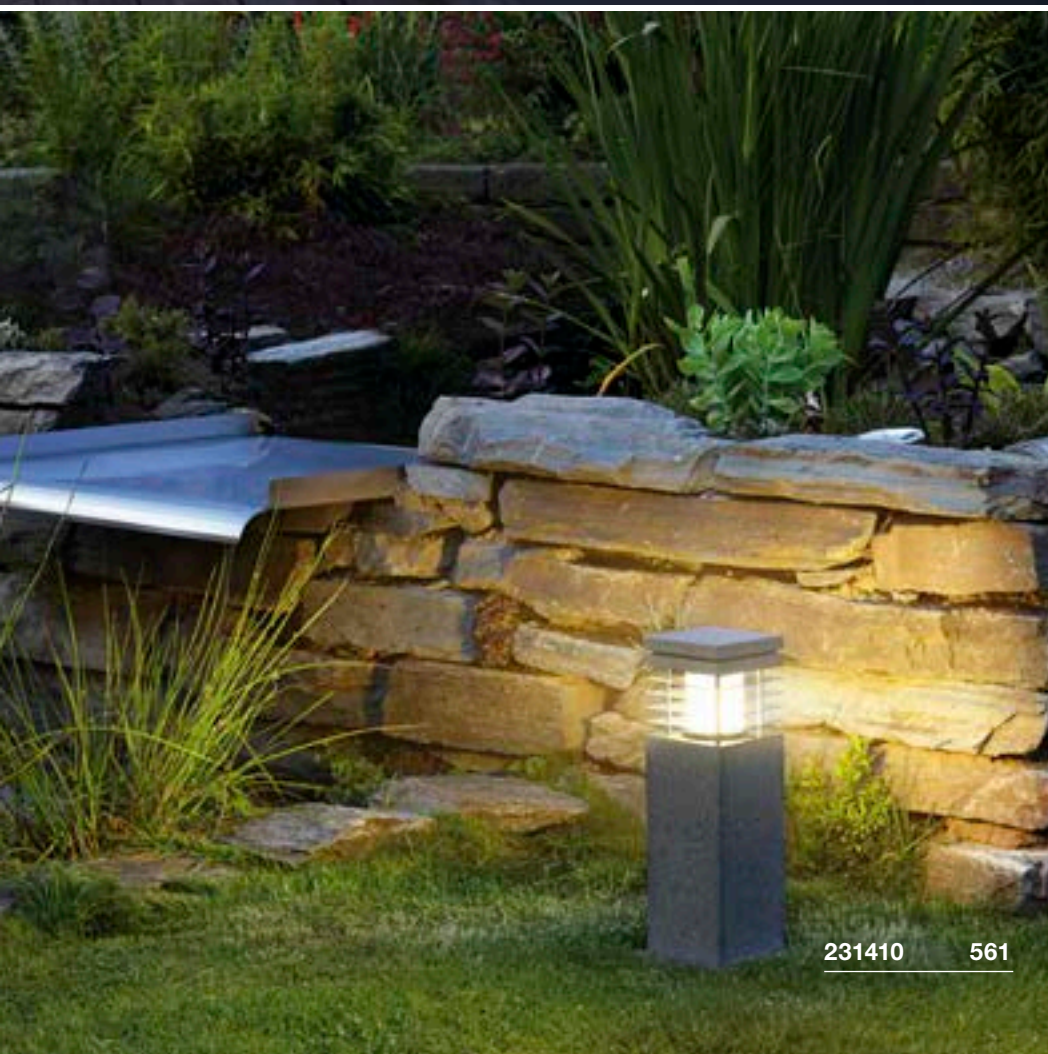

231410 561

ARROCK GRANITE 40/70

Pole, square, E27

A-A++ Spektrum
A++-E



- Naturstein, Granit, Edelstahl
- Natürlicher Look mit blendfreier Lichtwirkung

Produktangaben

230V ~50Hz
Material: Granit / Edelstahl 304

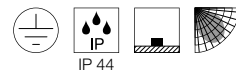

IP 44

Maßzeichnung

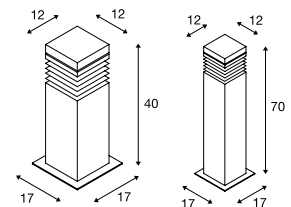

Zubehörempfehlung

■ Verbindungsbox IP68, 3-polig

Art. Nr. 228730

■ Erdspieß

Art. Nr. 229422



Leuchtmittlempfehlung

E27 9W 240°
3000K 810lm EEK=A+
10kWh/1000h
Art. Nr. 1001031



Leuchtmittelangaben

max. 15W
Ø: 5,2 cm max. L: 11,5 cm max.

Variante	Art. Nr.
E27 H: 40 cm 11 kg	
■ grau / chrom	231410
E27 H: 70 cm 22,5 kg	
■ grau / chrom	231411

ARROCK ARC
Pole, QPAR51

E-A++ Spektrum
A++-E

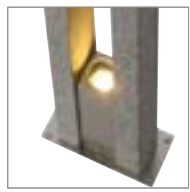

- Naturstein, Granit, Edelstahl
- Flaches Design mit außergewöhnlicher Lichtwirkung

Produktangaben

230V ~50Hz
Material: Granit / Edelstahl 304

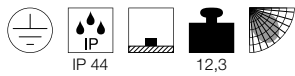

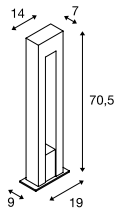

Maßzeichnung





Zubehörempfehlung

■ Erdspeiß 
Art. Nr. 231233

Leuchtmittlempfehlung

LED GU10 5,5W 38°  
2700K 400lm EEK=A+
6kWh/1000h
Art. Nr. 1001030

LED GU10 7,2W 36°  
4000K 540lm EEK=A+
8kWh/1000h
Art. Nr. 1001564

Leuchtmittelangaben

max. 35W QPAR51
Ø: 5 cm max. L: 7,6 cm max.

Variante	Art. Nr.
GU10 QPAR51	
■ grau / chrom	231420



231420 562



231817 563



231455 563

SLOTS 45 Pole



A-A++ Spektrum A++-E



- Indirekter Lichtaustritt
- Außergewöhnliche Lichtwirkung für einen sichern Tritt

Produktangaben

220-240V ~50/60Hz
Systemleistung: 6,3W
Material: Aluminium



Maßzeichnung

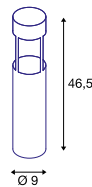

SLOTS 65 Pole



A-A++ Spektrum A++-E

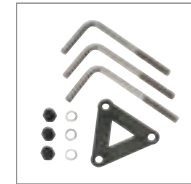

- Indirekter Lichtaustritt
- Außergewöhnliche Lichtwirkung für einen sichern Tritt

Produktangaben

220-240V ~50/60Hz
Systemleistung: 6,3W
Material: Aluminium



Maßzeichnung

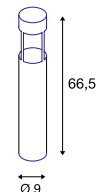

Zubehörempfehlung

- Verbindungsbox IP68, 3-polig
Art. Nr. 228730
- Schraubenset
Art. Nr. 228753



Variante	Art. Nr.
200lm 3000K CRI>80 ■ anthrazit	231815
200lm 3000K CRI>80 ■ rost	231817

Zubehörempfehlung

- Verbindungsbox IP68, 3-polig
Art. Nr. 228730
- Schraubenset
Art. Nr. 228753



Variante	Art. Nr.
200lm 3000K CRI>80 ■ anthrazit	231455
200lm 3000K CRI>80 ■ rost	231457

BOOKAT
Pole, TRIAC

A-A++ Spektrum
A++-E

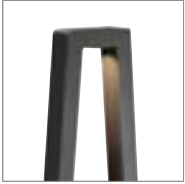

- Hochvolt LED

Produktangaben

230V ~50Hz
Systemleistung: 13W
Material: Aluminium
Dimmbar: Triac C, Triac L

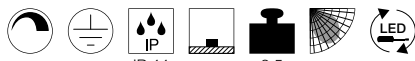

Maßzeichnung

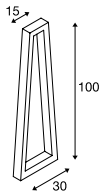

Hinweis

Offenes Kabelend

Zubehörempfehlung

■ Verbindungsbox IP68, 3-polig
Art. Nr. 228730



Variante Art. Nr.

370lm | 3000K | CRI>80

■ anthrazit 231855



231855 564

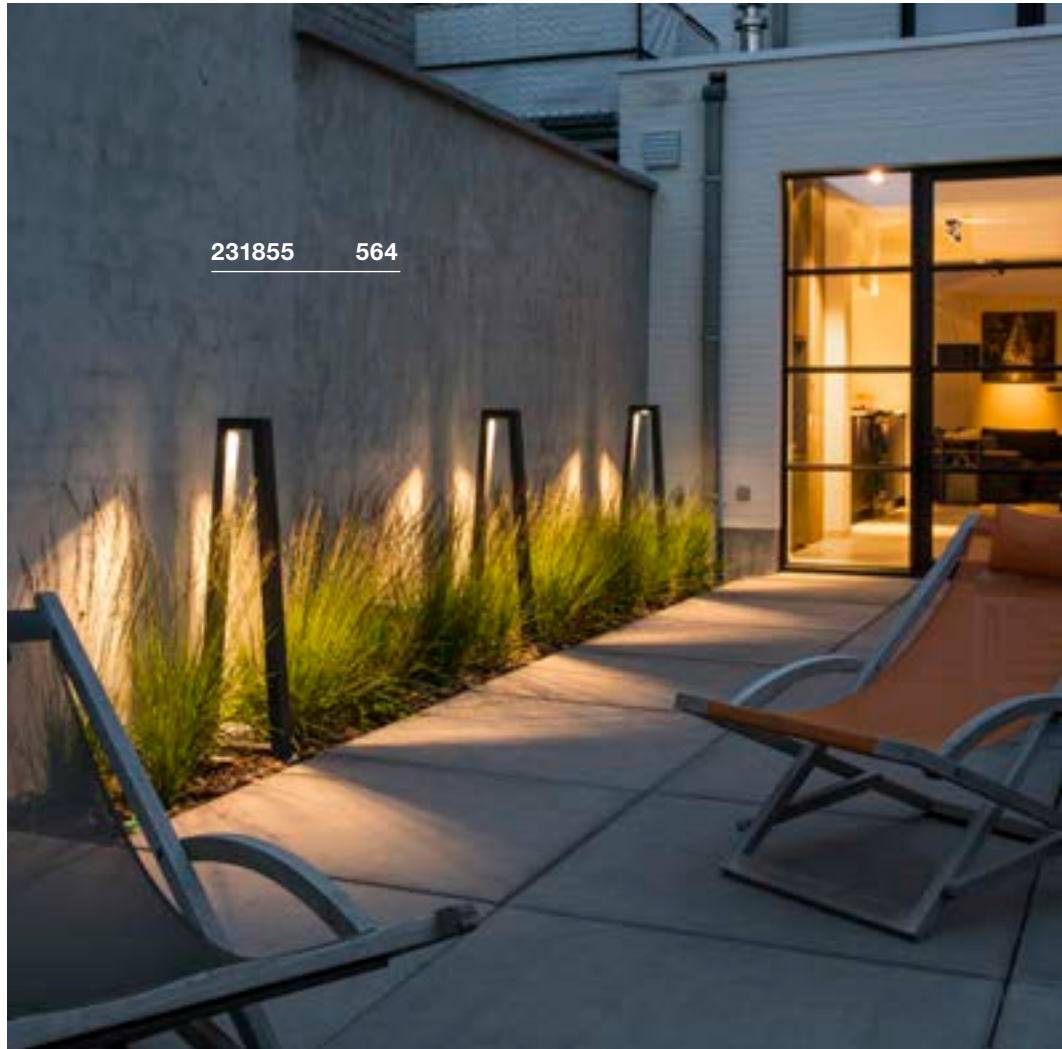

231855 564



1000801 565

RASCALI 45/65 Pole



A-A++ Spektrum A++-E

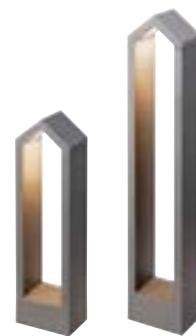

- Außergewöhnliches Design
- Achsensymmetrische Lichtverteilung zur Akzentuierung von Wegen und Flächen

Produktangaben

220-240V ~50Hz
Systemleistung: 8W
Material: Aluminium

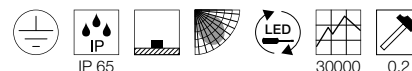

Maßzeichnung

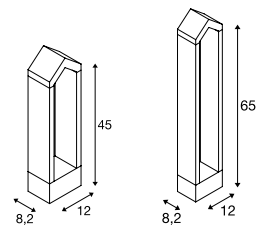

Variante	Art. Nr.
360lm 3000K CRI>80 H: 45 cm 2,25 kg ■ anthrazit	100799
360lm 3000K CRI>80 H: 65 cm 2,8 kg ■ anthrazit	1000801

H-POL 30/60
Pole

A-A++ Spektrum A++-E



- Einseitiger Lichtaustritt

Produktangaben

100-277V ~50/60Hz | 500mA
Material: Aluminium / Kunststoff
Einbaumaße: B: 11,8 cm L: 11,8 cm T: 10 cm

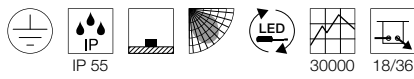

Maßzeichnung

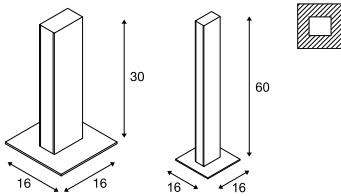

Hinweis

Das Produkt ist zum Bodeneinbau vorgesehen. Zur optionalen Montage im Erdreich steht ein größerer Einbautopf zur Verfügung. Einbaumaße des optionalen Einbautopfes: L: 14 cm B: 14 cm T: 16 cm.

Zubehöreffempfehlung

■ Einbautopf
Art. Nr. **232195**

Variante	Art. Nr.
350lm 3000K CRI>80 9W H: 36 cm 1,4 kg ■ anthrazit	232155
700lm 3000K CRI>80 18W H: 66 cm 2,3 kg ■ anthrazit	232165

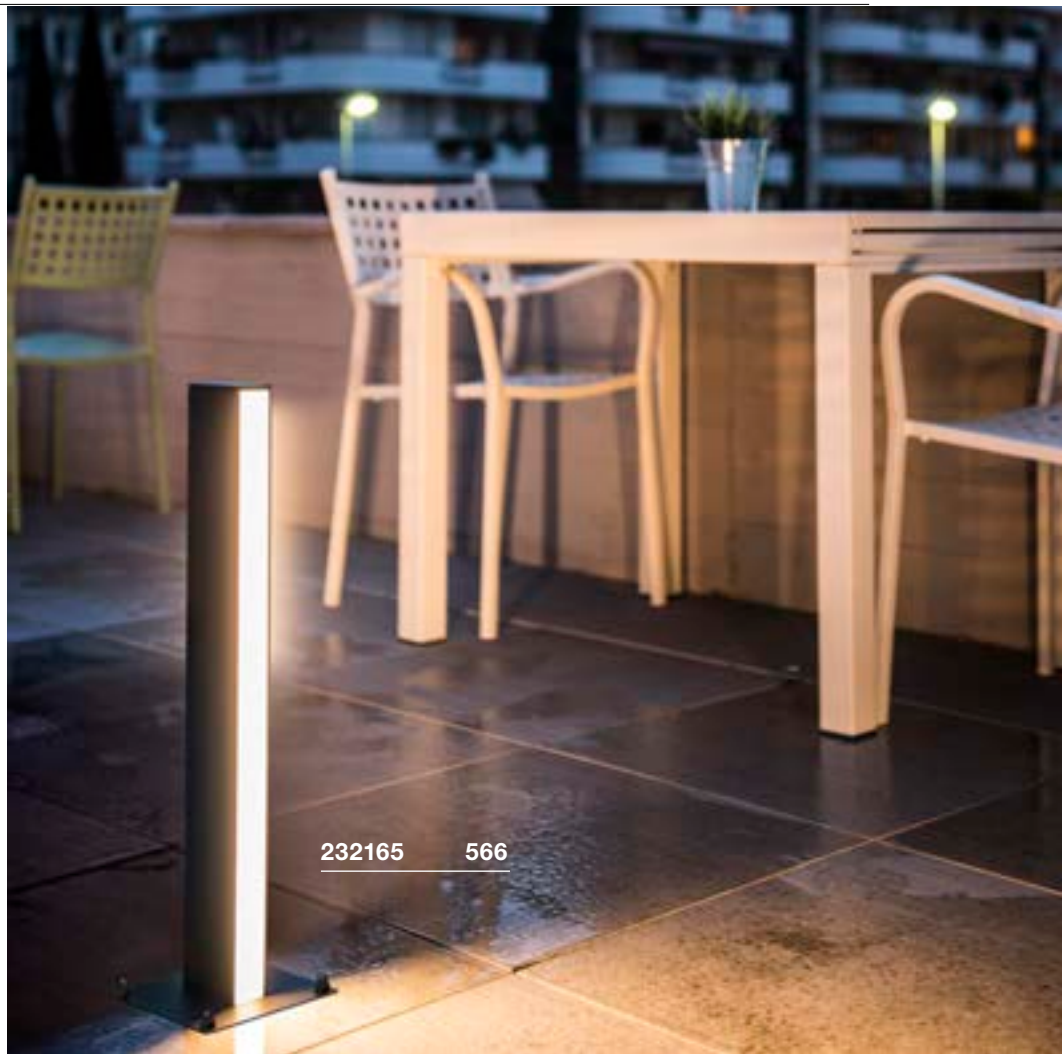

232165 566

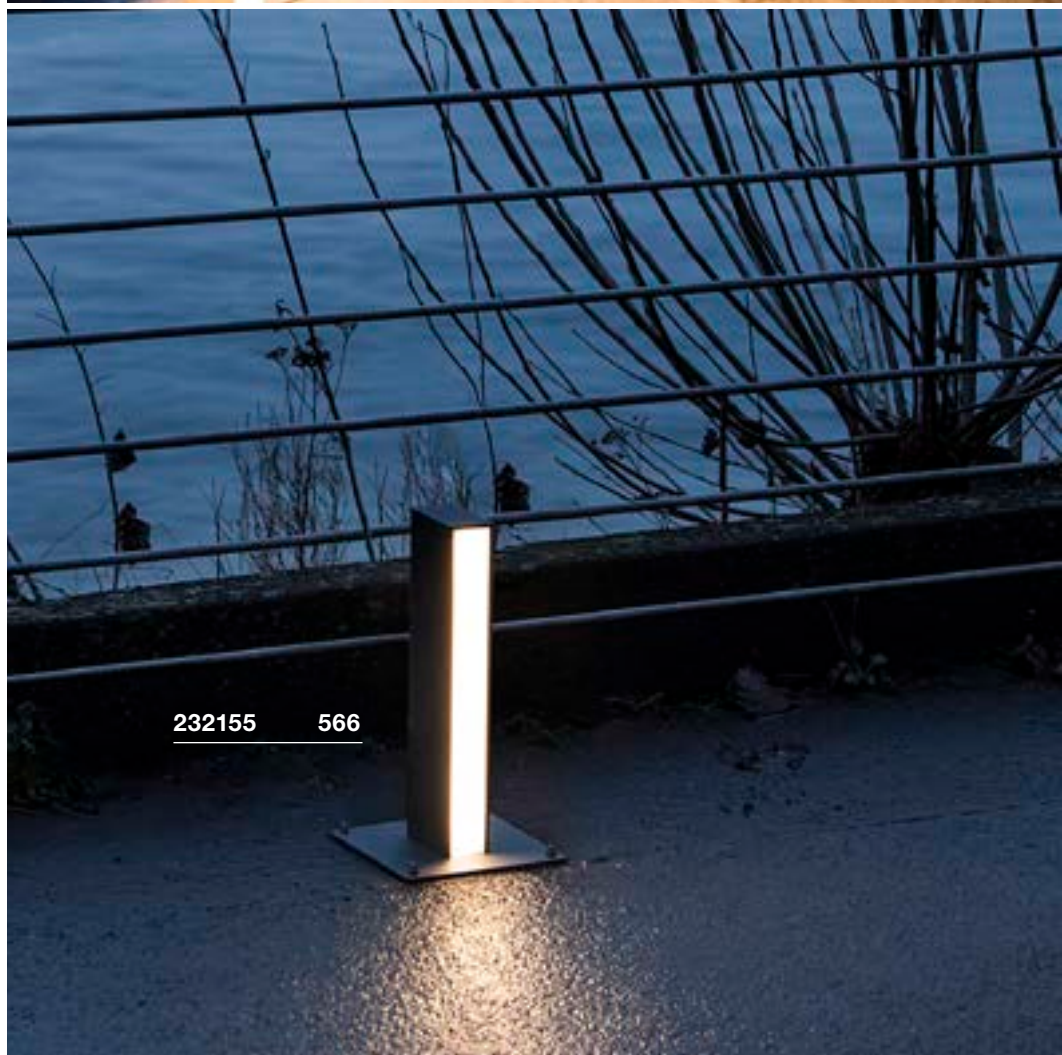

232155 566



232175 567

H-POL TWIN 30/60 Pole

A-A++ Spektrum
A++-ELED
INSIDE

- Beidseitiger Lichtaustritt

Produktangaben

220-240V ~50/60Hz | 1000mA
Material: Aluminium / Kunststoff
Einbaumaße: B: 11,8 cm L: 11,8 cm T: 10 cm



IP 55

30000

9/18

Maßzeichnung

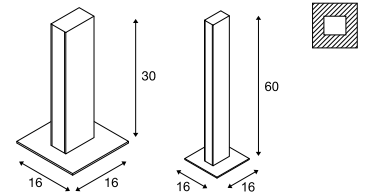

Hinweis

Das Produkt ist zum Bodeneinbau vorgesehen.
Zur optionalen Montage im Erdreich steht ein größerer Einbautopf zur Verfügung.
Einbaumaße des optionalen Einbautopfes:
L: 14 cm B: 14 cm T: 16 cm.

Zubehörempfehlung

■ Einbautopf

Art. Nr. 232195



Variante

Art. Nr.

Direkt: 350lm | 3000K | CRI>80
Indirekt: 350lm | 3000K | CRI>80
18W | H: 36 cm | 1,6 kg

■ anthrazit

232175

Direkt: 700lm | 3000K | CRI>80
Indirekt: 700lm | 3000K | CRI>80
35W | H: 66 cm | 2,5 kg

■ anthrazit

232185

SLOTBOX 40/70
Pole

A-A++ Spektrum A++-E

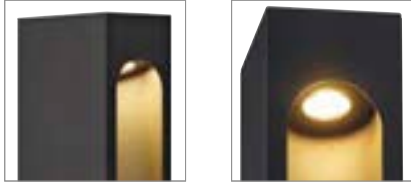

Produktangaben

200-240V ~50/60Hz | 700mA
Systemleistung: 8W
Material: Aluminium

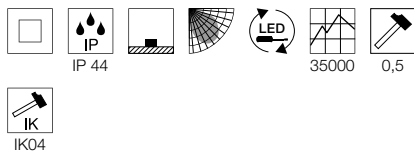

Maßzeichnung

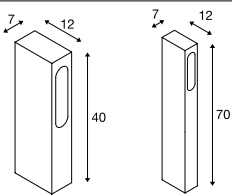

Hinweis

Offenes Kabelend

Zubehörempfehlung

■ Verbindungsbox IP68, 3-polig
Art. Nr. 228730



Variante	Art. Nr.
160lm 3000K CRI>80 H: 40 cm 1,45 kg ■ anthrazit	232135
160lm 3000K CRI>80 H: 70 cm 2,1 kg ■ anthrazit	232145





1002958 569

FLATT 65/100 Pole

887

A-A++ Spektrum A++-E

LED INSIDE

NEW



• Lichtfarbe schaltbar

Produktangaben

100-240V ~50/60Hz | 350mA
 Systemleistung: 9,7W
 Material: Aluminium / Aluminium



IP 65

0,35 IK03

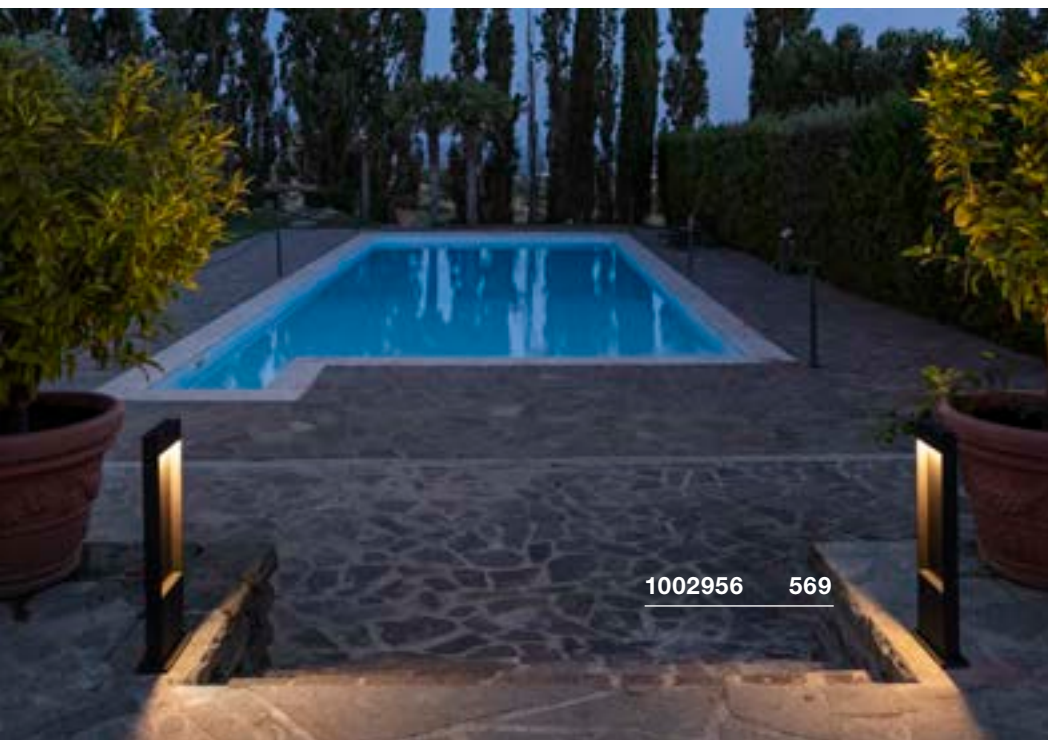

1002956 569

Variante	Art. Nr.
400lm 3000/4000K CRI80 L: 18 cm B: 4,5 cm H: 65 cm 3,2 kg ■ matt anthrazit / matt anthrazit	1002956
400lm 3000/4000K CRI80 L: 18 cm B: 4,5 cm H: 65 cm 3,2 kg ■ matt anthrazit / matt braun	1002957
400lm 3000/4000K CRI80 L: 18 cm B: 4,5 cm H: 100 cm 4,47 kg ■ matt anthrazit / matt anthrazit	1002958
400lm 3000/4000K CRI80 L: 18 cm B: 4,5 cm H: 100 cm 4,47 kg ■ matt anthrazit / matt braun	1002959

ARROCK STONE 50/70 Pole



- Basalt/Edelstahl
- Außergewöhnliche Lichtwirkung

Produktangaben

100-240V ~50/60Hz | 700mA
 Systemleistung: 9W
 Material: Basalt / Edelstahl 304

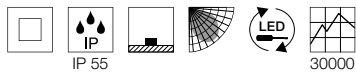

Maßzeichnung

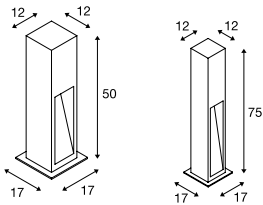

Zubehörempfehlung

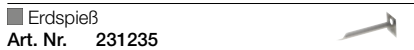

Variante	Art. Nr.
330lm 3000K CRI>80 H: 50 cm 15,5 kg ■ grau	231370
330lm 3000K CRI>80 H: 75 cm 22,2 kg ■ grau	231371

ARROCK SLOT Pole, QPAR51

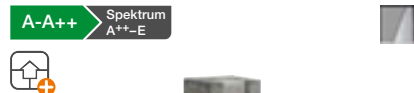

- Naturstein, Granit, Edelstahl
- Außergewöhnliche Lichtwirkung, natürlicher Look

Produktangaben

230V ~50Hz
 Material: Granit / Edelstahl 304

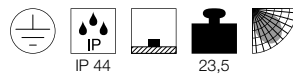

Maßzeichnung

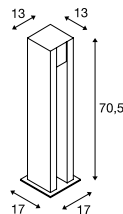

Hinweis

Offenes Kabelend

Zubehörempfehlung

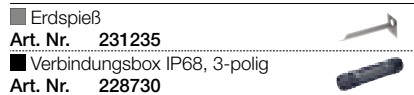

Leuchtmittlempfehlung

LED GU10 3,7W 36°
 2700K 260lm EEK=A+
 4kWh/1000h
 Art. Nr. 560122

Leuchtmittelangaben

max. 4W LED GU10 51mm

Variante	Art. Nr.
GU10 LED GU10 51mm ■ grau / chrom	231440

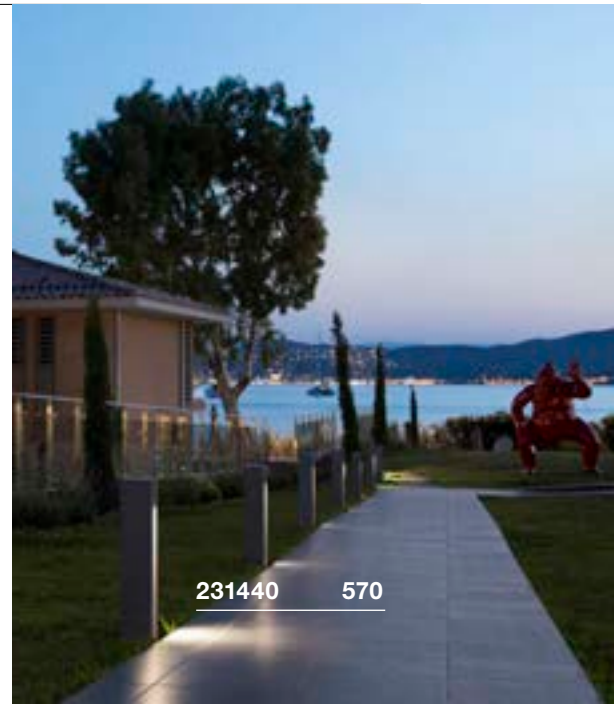

231440 570



231440 570

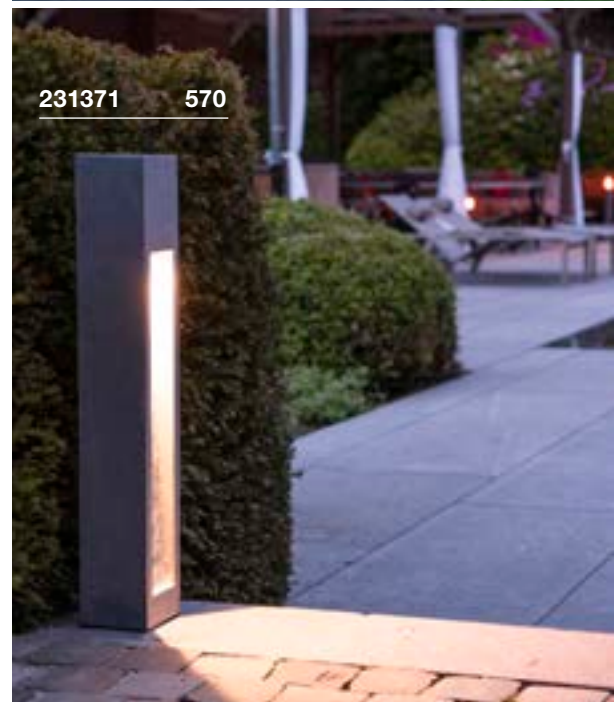

231371 570



229411 571



229410 571



233447 571

RUSTY® SLOT 50/80 Pole, E27

A-A++ Spektrum A++-E



Produktangaben

230V ~50Hz
Material: FeCSi-Stahl / Polycarbonat (PC)

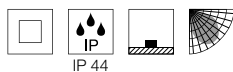

Maßzeichnung

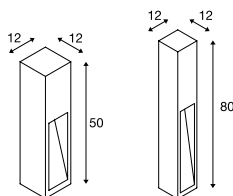

Zubehörempfehlung

■ Verbindungsbox IP68, 3-polig

Art. Nr. 228730

■ Erdspeiß

Art. Nr. 231230



Leuchtmittlempfehlung

E27 4,7W 360°
3000K 380lm EEK=A+
5kWh/1000h
Art. Nr. 551532

LED E27 9W 240°
3000K 810lm EEK=A+
10kWh/1000h
Art. Nr. 1001031



Leuchtmittelangaben

max. 11W
Ø: 4,8 cm max. L: 13,9 cm max.

Variante	Art. Nr.
E27 H: 50 cm 12,5 kg ■ rost	229410
E27 H: 80 cm 18,5 kg ■ rost	229411

RUSTY® SLOT 50/80 Pole

A-A++ Spektrum A++-E

LED INSIDE



Produktangaben

220-240V ~50/60Hz
Systemleistung: 8,6W
Material: FeCSi-Stahl / Polycarbonat (PC)

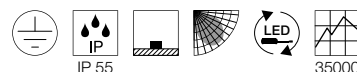

Maßzeichnung

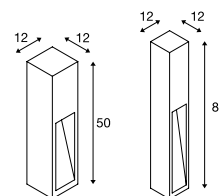

Hinweis

Offenes Kabelend

Zubehörempfehlung

■ Verbindungsbox IP68, 3-polig

Art. Nr. 228730

■ Erdspeiß

Art. Nr. 231230



Variante	Art. Nr.
30lm 3000K CRI>80 H: 50 cm 12,5 kg ■ rost	233447
30lm 3000K CRI>80 H: 80 cm 18,5 kg ■ rost	233457

BENDO 80/220
Pole, TRIAC



A-A++ Spektrum
A++-E

LED
INSIDE



reddot award 2018
winner

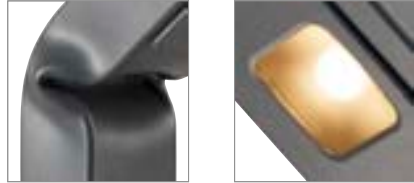

- Hochvolt LED
- Exklusives Design für den außergewöhnlichen Outdoor-Bereich

Produktangaben

220-240V ~50/60Hz
Material: Aluminium / Glas
Dimmbar: Triac C, Triac L

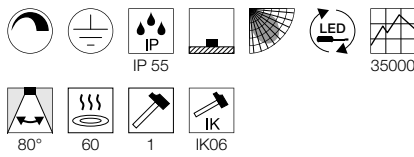

Maßzeichnung

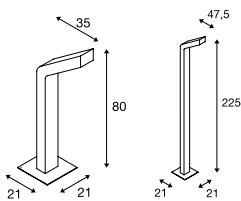

Zubehörempfehlung

- Betonanker
Art. Nr. **231849**
- Verbindungsbox IP68, 3-polig
Art. Nr. **228730**
- T-Verbinderbox
Art. Nr. **228726**

Variante	Art. Nr.
700lm 3000K CRI>80 H: 80 cm 11W 2,7 kg ■ anthrazit	231835
1800lm 3000K CRI>80 H: 225 cm 31W 7,3 kg ■ anthrazit	231845

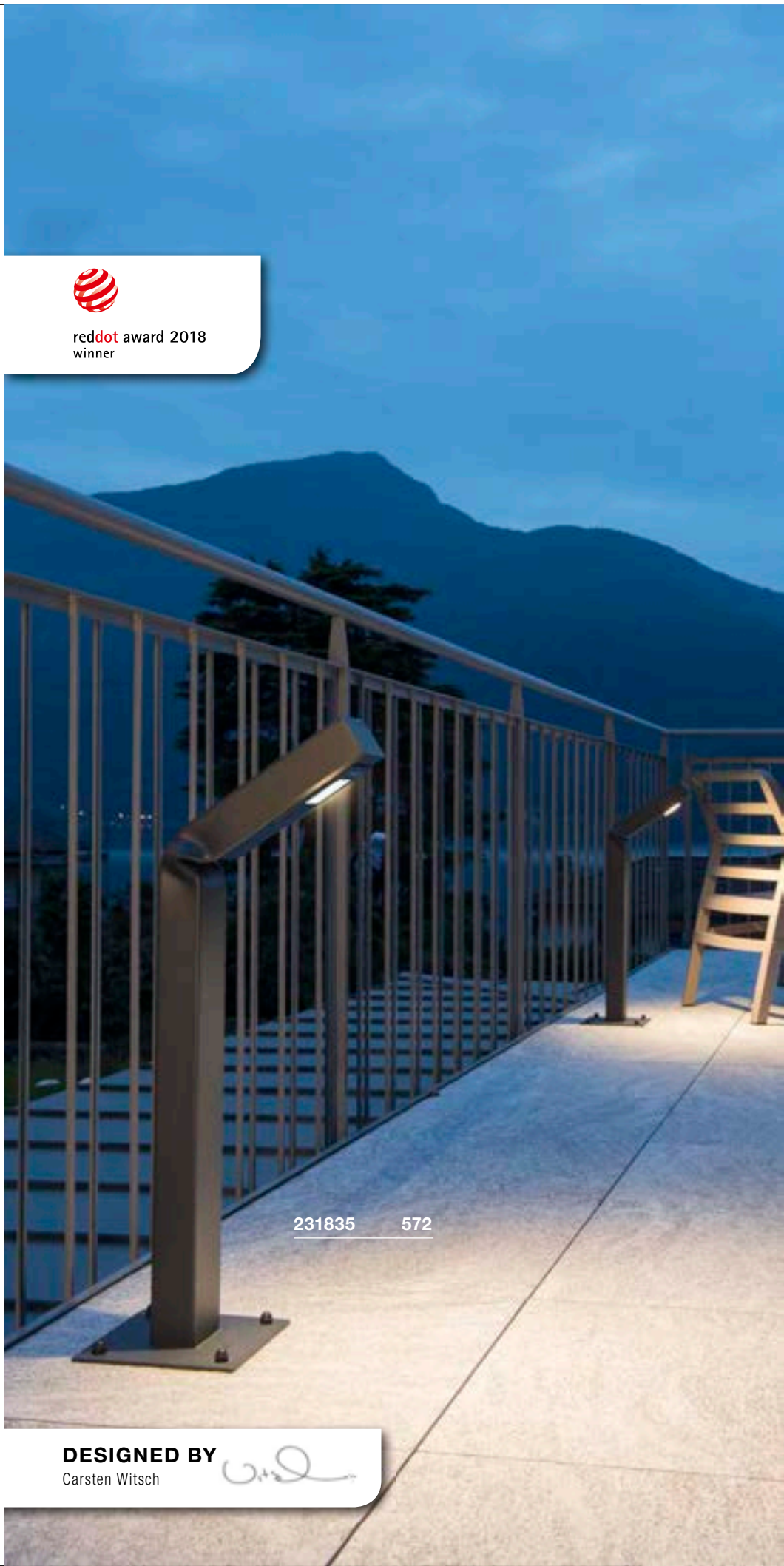

reddot award 2018
winner

231835 572

DESIGNED BY
Carsten Witsch





230090 573



230090 573



1001824 573

RUSTY® PATHLIGHT
Pole, TCR-TSE

B-A++ Spektrum A++-E



- Stahl gerostet
- Jede Leuchte ist ein Unikat
- Geradliniger, natürlicher Look

Produktangaben

230V ~50Hz
Material: FeCSi-Stahl / Polycarbonat (PC)

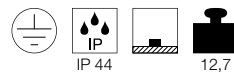

Maßzeichnung

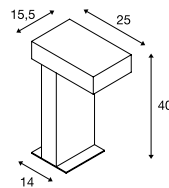

Zubehörempfehlung

- Verbindungsbox IP68, 3-polig
Art. Nr. 228730
- Erdspeiß
Art. Nr. 229422

Leuchtmittlempfehlung

- GX53 3W 120°
3000K 250lm EEK=A++
3kWh/1000h
Art. Nr. 551372

Leuchtmittelangaben

max. 9W TCR-TSE
Ø: 7,5 cm max. L: 2,7 cm max.

Variante	Art. Nr.
GX53 TCR-TSE	
■ rost	230090

RUSTY® PATHLIGHT 40/70
Pole

A-A++ Spektrum A++-E



LED INSIDE



- Stahl gerostet
- Jede Leuchte ist ein Unikat

Produktangaben

220-240V ~50/60Hz
Systemleistung: 8,9W
Material: FeCSi-Stahl / Polycarbonat (PC)

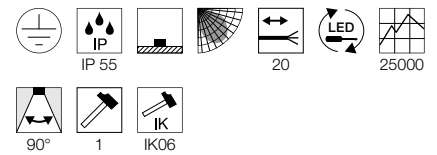

Maßzeichnung

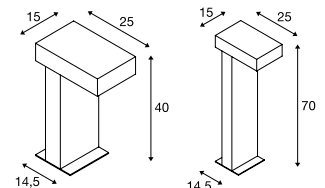

Hinweis

Offenes Kabelend

Zubehörempfehlung

- Verbindungsbox IP68, 3-polig
Art. Nr. 228730
- Erdspeiß
Art. Nr. 229422

Variante	Art. Nr.
400lm 3000K CRI>80 H: 40 cm	12,5 kg
■ rost	1001823
400lm 3000K CRI>80 H: 70 cm	18,9 kg
■ rost	1001824

ABRIDOR 60/100
Pole



A-A++ Spektrum
A++-E

LED
INSIDE

NEW

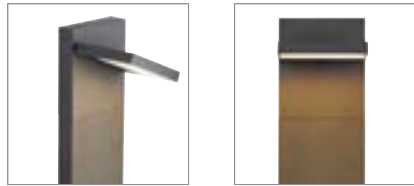

- Lichtfarbe schaltbar
- Schwenkbarer Leuchtenkopf

Produktangaben

100-277V ~50/60Hz | 300mA
Systemleistung: 14W
Material: Aluminium
Produktmaße: 14 cm B: 3,6 cm H: 60 cm

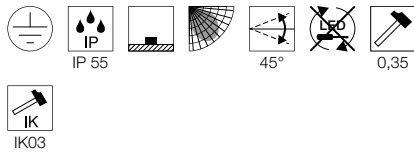

Hinweis

Offenes Kabelend

Zubehörempfehlung

■ Verbindungsbox IP68, 3-polig
Art. Nr. **228730**



Variante	Art. Nr.
750lm 3000/4000K CRI80 H: 60 cm 2,3 kg ■ matt anthrazit	1002991
750lm 3000/4000K CRI80 H: 100 cm 3,4 kg ■ matt anthrazit	1002992

1002992 574

231355 641





231305 575



232294 575



232294 575

IPERI 50
Pole



A-A++ Spektrum A++-E



QUADRASYL 75
Pole, TCR-TSE



B-A++ Spektrum A++-E



- Wegweiser für Einfahrt und Garten

Produktangaben

230V ~50Hz
Systemleistung: 5W
Material: Aluminium / Kunststoff

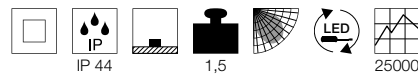

Maßzeichnung

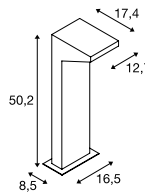

Produktangaben

220-240V ~50/60Hz
Material: Aluminium

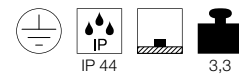

Maßzeichnung

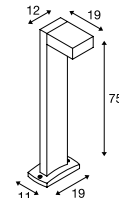

Zubehörempfehlung

■ Erdspeiß

Art. Nr. 231231



Zubehörempfehlung

■ T-Verbindebox

Art. Nr. 228726



Leuchtmittelempfehlung

GX53 3W 120°
3000K 250lm EEK=A++
3kWh/1000h
Art. Nr. 551372



Leuchtmittelangaben

max. 11W TCR-TSE
Ø: 7,5 cm max. L: 2,7 cm max.

Variante	Art. Nr.
320lm 4000K CRI>70 ■ anthrazit	231305

Variante	Art. Nr.
GX53 TCR-TSE ■ grau	232294
GX53 TCR-TSE ■ anthrazit	232295

TRAPECCO
Pole



A-A++ Spektrum A++-E



Produktangaben

230V ~50Hz
Systemleistung: 10W
Material: Aluminium

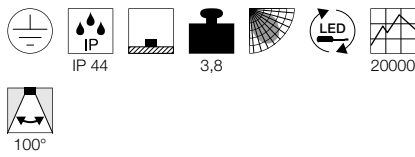

Maßzeichnung

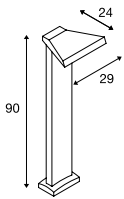

Hinweis

Offenes Kabelend

Zubehörempfehlung

■ Verbindungsbox IP68, 3-polig
Art. Nr. 228730



Variante	Art. Nr.
850lm 3000K CRI>80 ■ anthrazit	231765

MALU
Pole



A-A++ Spektrum A++-E



reddot award 2019 winner



Produktangaben

220-240V ~50/60Hz
Systemleistung: 9,2W
Material: Aluminium / Glas

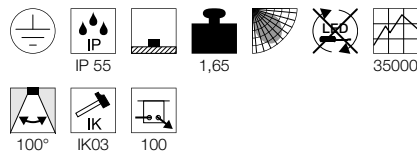

Maßzeichnung

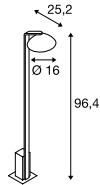

Hinweis

Integrierte Verbindungsbox

Variante	Art. Nr.
360lm 3000K CRI>80 ■ anthrazit	1002158

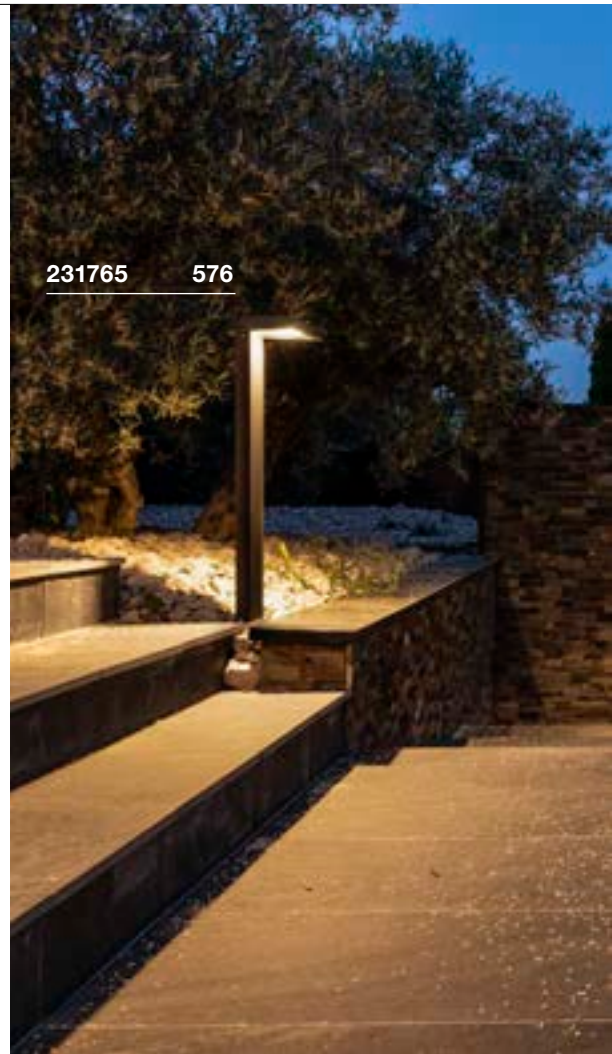

231765 576



reddot award 2019 winner

1002158 576

DESIGNED BY
Philippe Stephant



228545 577



1002907 577

ENOLA C
Pole



A-A++ Spektrum A++-E



Produktangaben

100-240V ~50/60Hz | 500mA
Systemleistung: 12W
Material: Aluminium / Glas

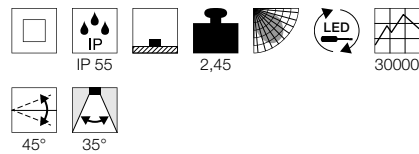

Maßzeichnung

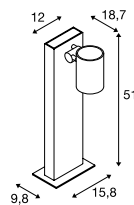

Hinweis

Offenes Kabelend

Zubehörempfehlung

■ Verbindungsbox IP68, 3-polig
Art. Nr. 228730



Variante	Art. Nr.
800lm 3000K CRI>80 ■ anthrazit	228545

ESKINA 30/80
Pole



A-A++ Spektrum A++-E



Produktangaben

220-240V ~50/60Hz | 350mA
Systemleistung: 14,5W
Material: Aluminium
Dimmbar: Triac C

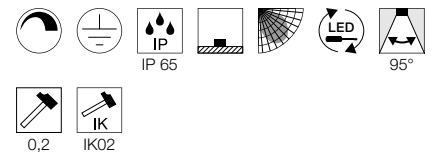

Maßzeichnung

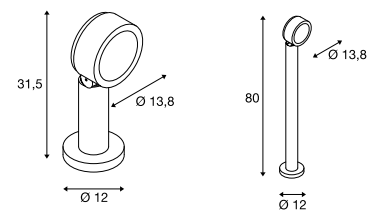

Hinweis

1002906 – Schutzkontaktstecker
1002907 – Offenes Kabelend

Zubehörempfehlung

■ Erdspieß
Art. Nr. 230060



Variante	Art. Nr.
1000lm 3000/4000K CRI>80 Ø: 31,5 cm 1,3 kg ■ matt anthrazit	1002906
1000lm 3000/4000K CRI>80 Ø: 80 cm 1,89 kg ■ matt anthrazit	1002907

THEO PATHLIGHT
Pole, single



A-A++ Spektrum A++-E

NEW



Produktangaben

200-240V ~50/60Hz
Material: Aluminium
Produktmaße: B: 14 cm H: 72,5 cm

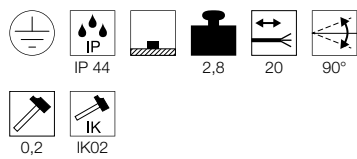

Hinweis

Offenes Kabelend

Leuchtmittlempfehlung

LED GU10 3,7W 36°
2700K 260lm EEK=A+
4kWh/1000h
Art. Nr. 560122



Leuchtmittelangaben

max. 7W

Variante	Art. Nr.
GU10 ■ matt anthrazit	1002870

THEO PATHLIGHT
Pole, double



A-A++ Spektrum A++-E

NEW



Produktangaben

200-240V ~50/60Hz
Material: Aluminium
Produktmaße: B: 21,2 cm H: 72,5 cm

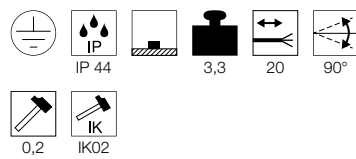

Hinweis

Offenes Kabelend

Leuchtmittlempfehlung

LED GU10 3,7W 36°
2700K 260lm EEK=A+
4kWh/1000h
Art. Nr. 560122



Leuchtmittelangaben

2x max. 7W

Variante	Art. Nr.
GU10 ■ matt anthrazit	1002871



1002871 578



1003001 579

QUAD POLE



A-A++

Spektrum
A++-ELED
INSIDE

NEW

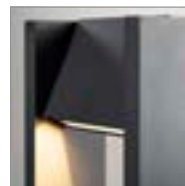

- Schwenkbarer Leuchtenkopf

Produktangaben

100-277V ~50/60Hz | 500mA

Systemleistung: 18W

Material: Aluminium / Glas

Produktmaße: L: 12 cm B: 23 cm H: 90 cm



IP 65



6



20



LED



25000



180°



100°



0,2



IK02

Maßzeichnung

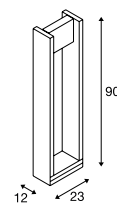

Hinweis

Offenes Kabelend

Zubehöreffhlung

■ Verbindungsbox IP68, 3-polig

Art. Nr. 228730



Variante

1550lm | 3000K | CRI>80

■ matt anthrazit

Art. Nr.

1003001

HELIA
Pole, single, TRIAC



A-A++ Spektrum A++-E



- Hochvolt LED

Produktangaben

220-240V ~50/60Hz
Systemleistung: 8W
Material: Aluminium / Glas
Dimmbar: Triac C, Triac L

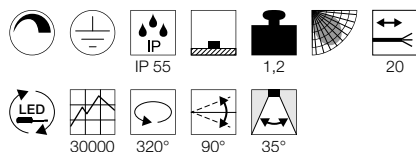

Maßzeichnung

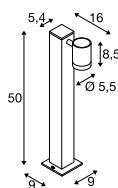

Hinweis

Offenes Kabelend

Zubehörempfehlung

- Erdspieß
Art. Nr. 1000736
- Verbindungsbox IP68, 3-polig
Art. Nr. 228730

Variante	Art. Nr.
450lm 3000K CRI>80 ■ anthrazit	1002198

HELIA SENSOR
Single



A-A++ Spektrum A++-E



- Integrierter Infrarot-Sensor
- Hochvolt LED

Produktangaben

220-240V ~50/60Hz
Systemleistung: 8W
Material: Aluminium

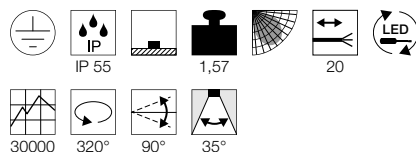

Maßzeichnung

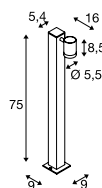

Hinweis

Offenes Kabelend

Zubehörempfehlung

- Erdspieß
Art. Nr. 1000736
- Verbindungsbox IP68, 3-polig
Art. Nr. 228730

Variante	Art. Nr.
450lm 3000K CRI>80 ■ anthrazit	1002199



1002199 580

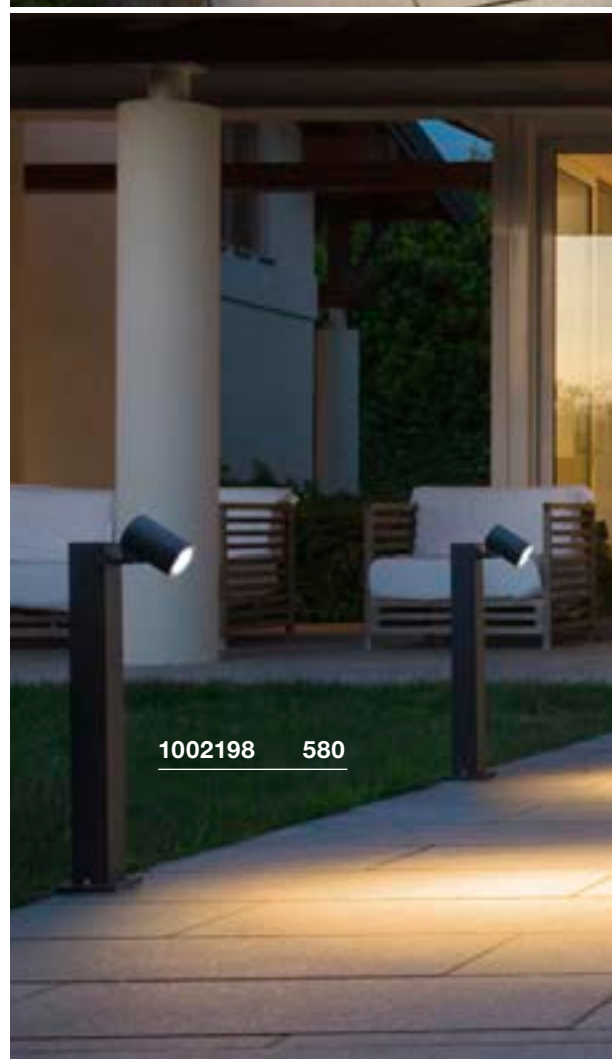

1002198 580



1002200 581

HELIA
Pole, double, TRIAC 888A-A++ Spektrum
A++-E**LED**
INSIDE

- Hochvolt LED

Produktangaben

220-240V ~50/60Hz
Systemleistung: 16W
Material: Aluminium / Glas
Dimmbar: Triac C, Triac L

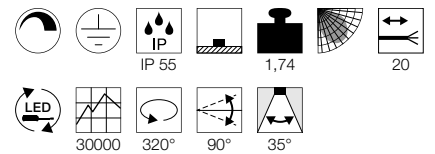
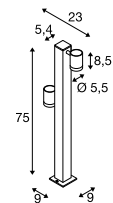
**Maßzeichnung****Hinweis**

Offenes Kabelend

Zubehörempfehlung

- Erdspieß
Art. Nr. 1000736
- Verbindungsbox IP68, 3-polig
Art. Nr. 228730



Variante	Art. Nr.
900lm 3000K CRI>80 ■ anthrazit	1002200

SITRA 360
Pole, TCR-TSE



B-A++ Spektrum
A++-E



231505 582

Produktangaben

230V ~50Hz
Material: Aluminium / Glas

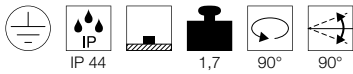

Maßzeichnung

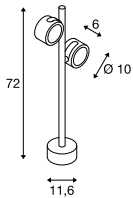

Zubehöreffahrung

Erdspeiß
Art. Nr. 230060



Leuchtmittelpfehlung

GX53 3W 120°
3000K 250lm EEK=A++
3kWh/1000h
Art. Nr. 551372



LED GX53 8,2W 120°
4000K 620lm EEK=A+
9kWh/1000h
Art. Nr. 550074



Leuchtmittelangaben

2x max. 9W TCR-TSE
Ø: 7,5 cm max. L: 3,5 cm max.

Variante	Art. Nr.
GX53 TCR-TSE	
anthrazit	231505



233285 583



MYRA SPOT
Double, GU10



A-A++ Spektrum A++-E



- Verlängerbar
- Außergewöhnliches Design für einen sicheren Tritt

Produktangaben

220-240V ~50/60Hz
Material: Aluminium

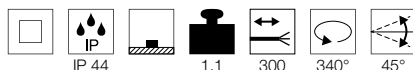

Maßzeichnung

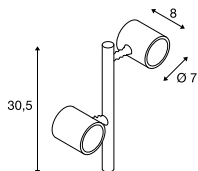

Hinweis

Die Leuchtenhöhe kann max. durch 2 Verlängerungsstäbe erhöht werden.
Offenes Kabelend

Zubehörempfehlung

- Schraubenset
Art. Nr. 228752
- Betonanker
Art. Nr. 228712
- Verlängerungsstab 30 cm
Art. Nr. 233164
- Standfuß
Art. Nr. 233144
- Verlängerungsstab 30 cm
Art. Nr. 233165
- Standfuß
Art. Nr. 233145

Leuchtmittlempfehlung

LED GU10 3,7W 36°
2700K 260lm EEK=A+
4kWh/1000h
Art. Nr. 560122



Leuchtmittelangaben

2x max. 4,5W LED GU10 51mm
Ø: 5 cm max. L: 5,7 cm max.

Variante	Art. Nr.
GU10 LED GU10 51mm	
■ grau	233184
GU10 LED GU10 51mm	
■ anthrazit	233185

HELIA
Pole, single, TRIAC



A-A++ Spektrum A++-E



- Hochvolt LED

Produktangaben

220-240V ~50/60Hz
Systemleistung: 8W
Material: Aluminium
Dimmbar: Triac C, Triac L

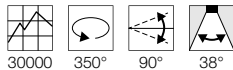

Maßzeichnung

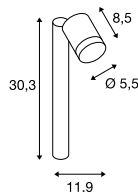

Hinweis

Die Leuchtenhöhe kann max. durch 2 Verlängerungsstäbe erhöht werden.
Offenes Kabelend

Zubehörempfehlung

- Verlängerungsstab 30 cm
Art. Nr. 233165
- Standfuß
Art. Nr. 233145
- Schraubenset
Art. Nr. 228752
- Betonanker
Art. Nr. 228712

Variante	Art. Nr.
450lm 3000K CRI>80	
■ anthrazit	233275

HELIA
Pole, double, TRIAC



A-A++ Spektrum A++-E

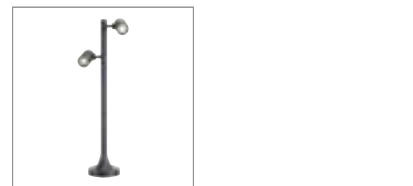

- Hochvolt LED

Produktangaben

220-240V ~50/60Hz
Systemleistung: 16W
Material: Aluminium
Dimmbar: Triac C, Triac L

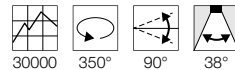
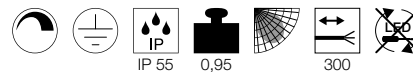

Maßzeichnung

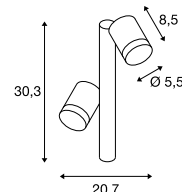

Hinweis

Die Leuchtenhöhe kann max. durch 2 Verlängerungsstäbe erhöht werden.
Offenes Kabelend

Zubehörempfehlung

- Verlängerungsstab 30 cm
Art. Nr. 233165
- Standfuß
Art. Nr. 233145
- Schraubenset
Art. Nr. 228752
- Betonanker
Art. Nr. 228712

Variante	Art. Nr.
900lm 3000K CRI>80	
■ anthrazit	233285

DA GEHT DIE SONNE AUF.

STRAHLER SETZEN DYNAMISCHE LICHTAKZENTE.

Sie möchten einen Außenbereich effektiv beleuchten?
Dann entdecken Sie gleich die große Vielfalt an Strahlern, die eine ganz individuelle Beleuchtung ermöglichen. Zum Beispiel an Gebäuden, auf Plätzen, Wegen oder in Gärten.





231035

589

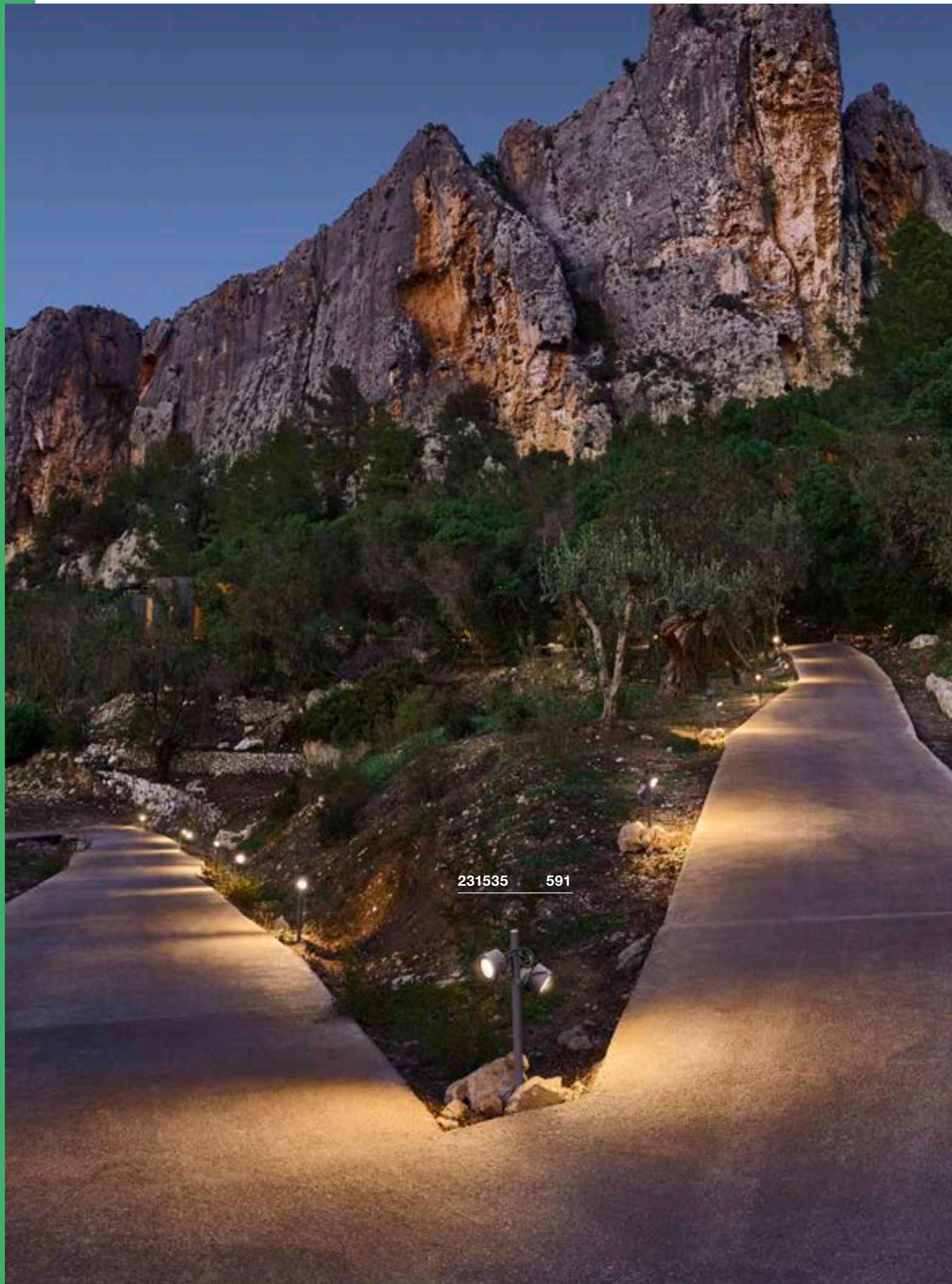

231535 591

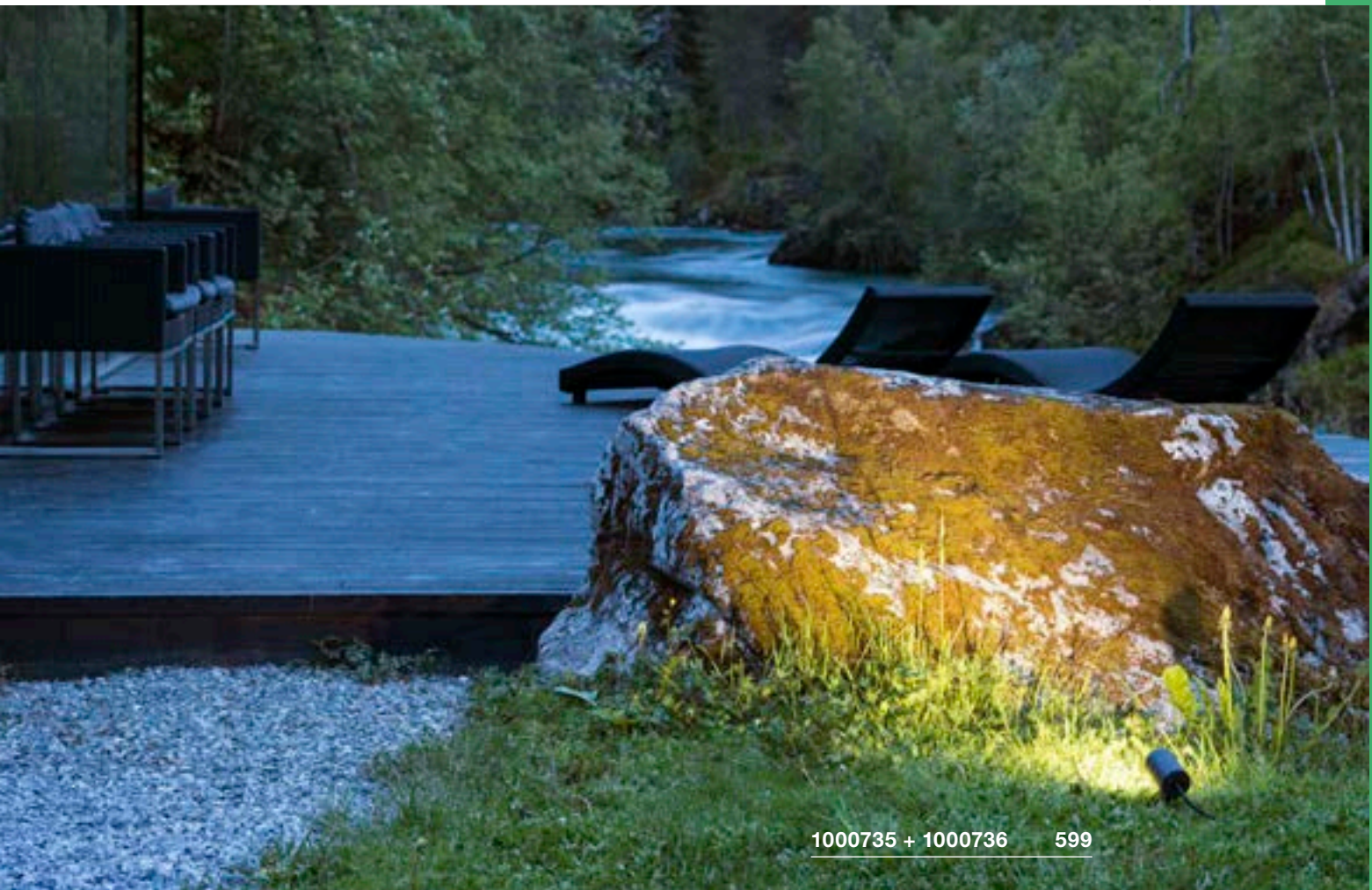

1000735 + 1000736 599

STRAHLER

 588	 588	 589	 589	 590	 590	 591	 591
 593	 593	 595	 597	 597	 597	 598	 598
 599	 599	 600	 601	 603	 603	 603	 604
 604	 605	 605	 606	 606	 607	 607	 608
 609	 609						

 Weitere Leuchten und Varianten finden Sie online unter www.slv.com

NAUTILUS 10
SP, round, QPAR51



E-A++ Spektrum
A++-E



BIG NAUTILUS
SP, round, QPAR51



B-A++ Spektrum
A++-E



Produktangaben

230V ~50Hz
Material: Aluminium



Produktangaben

230V ~50Hz
Material: Aluminium



Maßzeichnung

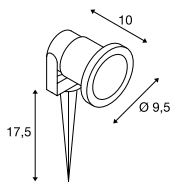

Maßzeichnung

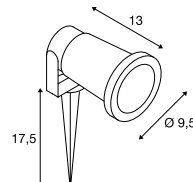

Hinweis

IP-Schutzkontaktstecker
Erdspieß inkl.

Hinweis

IP-Schutzkontaktstecker
Erdspieß inkl.

Leuchtmittlempfehlung

LED GU10 5,5W 38°
2700K 400lm EEK=A+
6kWh/1000h
Art. Nr. 1001030



Leuchtmittlempfehlung

LED GU10 5,5W 38°
2700K 400lm EEK=A+
6kWh/1000h
Art. Nr. 1001030



LED GU10 5,1W 48°
2700-6500K 350lm EEK=A+
6kWh/1000h
Art. Nr. 1001918



LED GU10 5,1W 48°
2700-6500K 350lm EEK=A+
6kWh/1000h
Art. Nr. 1001918



Leuchtmittelangaben

max. 35W QPAR51
L: 5,7 cm max.

Leuchtmittelangaben

max. 11W QPAR51
Ø: 5 cm max. L: 8,3 cm max.

Variante	Art. Nr.
GU10 QPAR51	
■ grau	227418

Variante	Art. Nr.
GU10 LED GU10 51mm	
■ schwarz	227410
GU10 LED GU10 51mm	
■ rost	1001964
GU10 LED GU10 51mm	
■ grün	1001965



227418 588



231035 589

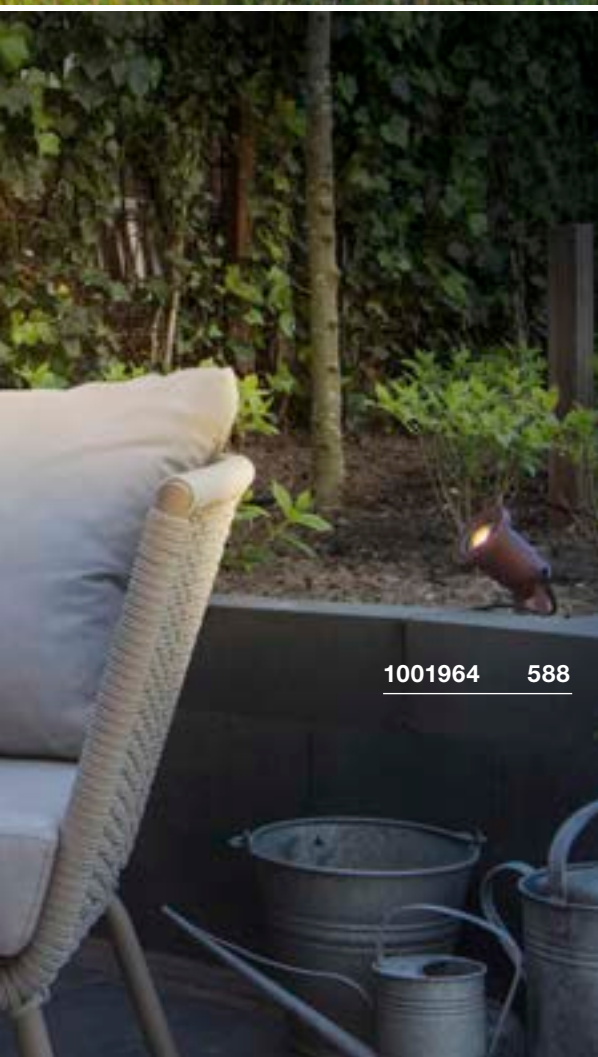

1001964 588

NAUTILUS 10
SP, round, QPAR51



E-A++ Spektrum A++-E



- Edelstahl 316

Produktangaben

230V ~50Hz
Material: Edelstahl 316

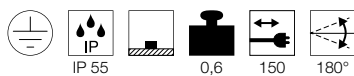

Maßzeichnung

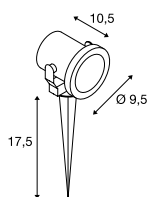

Hinweis

IP-Schutzkontaktstecker
Erdspieß inkl.

Leuchtmittelpfegung

GU10 4,3W 40°
3000K 245lm EEK=A+
5kWh/1000h
Art. Nr. 551253



LED GU10 5,6W 60°
2200-6700K 350lm EEK=A+
6kWh/1000h
Art. Nr. 1001919



Leuchtmittelangaben

max. 25W QPAR51
Ø: 5 cm max. L: 5,7 cm max.

Variante	Art. Nr.
GU10 QPAR51	
■ matt edelstahl	229740

NAUTILUS 10
SP, square



A-A++ Spektrum A++-E

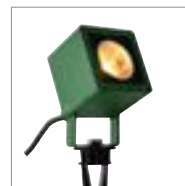

- Ideal geeignet zur gezielten Akzentuierung von Objekten und Bereichen

Produktangaben

100-240V ~50/60Hz | 700mA
Systemleistung: 8,5W
Material: Aluminium / Glas

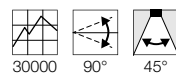

Maßzeichnung

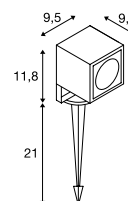

Hinweis

IP-Schutzkontaktstecker
Erdspieß inkl.

Variante	Art. Nr.
620lm 3000K CRI>80	
■ anthrazit	231035
620lm 3000K CRI>80	
■ rost	1001937
620lm 3000K CRI>80	
■ grün	1001938

LED SPIKE
SP



- Ideal geeignet zur gezielten Akzentuierung von Objekten und Bereichen

Produktangaben

100-240V ~50/60Hz | 240mA
Systemleistung: 6W
Material: Aluminium / Glas

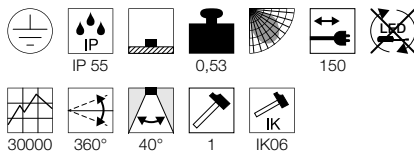

Maßzeichnung

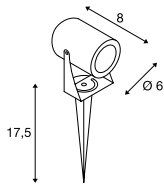

Hinweis

IP-Schutzkontaktstecker
Erdspeiß inkl.

SYNA
SP

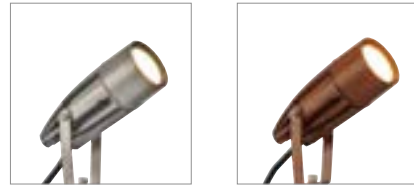

- Hochvolt LED

Produktangaben

220-240V ~50/60Hz
Systemleistung: 8,6W
Material: Aluminium / Glas

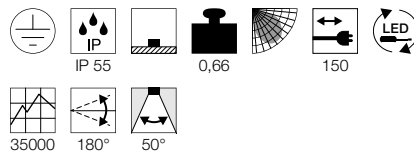

Maßzeichnung

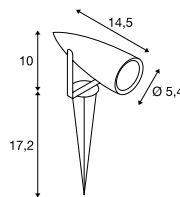

Hinweis

IP-Schutzkontaktstecker
Erdspeiß inkl.



1002201 590



227507 590

Variante	Art. Nr.
400lm 3000K CRI>80 ■ anthrazit	1002201
400lm 3000K CRI>80 ■ grün	1002202
400lm 3000K CRI>80 ■ rost	1002203

Variante	Art. Nr.
470lm 3000K CRI>80 ■ grau / transparent	227504
470lm 3000K CRI>80 ■ anthrazit	227505
470lm 3000K CRI>80 ■ rost	227507
470lm 3000K CRI>80 ■ grün	227508



231535 591



231535 591

SITRA 360 SPIKE
SP, single, TCR-TSE



B-A++ Spektrum A++-E



Produktangaben

230V ~50Hz
Material: Aluminium / Glas



Maßzeichnung

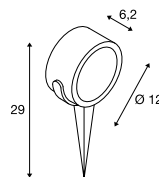

Hinweis

IP-Schutzkontaktstecker
Erdspeiß inkl.

Leuchtmittlempfehlung

GX53 3W 120°
3000K 250lm EEK=A++
3kWh/1000h
Art. Nr. 551372

LED GX53 8,2W 120°
4000K 620lm EEK=A+
9kWh/1000h
Art. Nr. 550074

Leuchtmittelangaben

max. 9W TCR-TSE
Ø: 7,5 cm max. L: 3,5 cm max.

Variante	Art. Nr.
GX53 TCR-TSE	
■ anthrazit	231525

SITRA 360 SPIKE
SP, double, TCR-TSE



B-A++ Spektrum A++-E



Produktangaben

230V ~50Hz
Material: Aluminium / Glas



Maßzeichnung

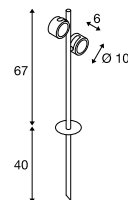

Hinweis

IP-Schutzkontaktstecker
Erdspeiß inkl.

Leuchtmittlempfehlung

GX53 3W 120°
3000K 250lm EEK=A++
3kWh/1000h
Art. Nr. 551372

LED GX53 8,2W 120°
4000K 620lm EEK=A+
9kWh/1000h
Art. Nr. 550074

Leuchtmittelangaben

2x max. 9W TCR-TSE
Ø: 7,5 cm max. L: 3,5 cm max.

Variante	Art. Nr.
GX53 TCR-TSE	
■ anthrazit	231535



231682 593



CV SPOT
SP, short

A-A++ Spektrum A++-E

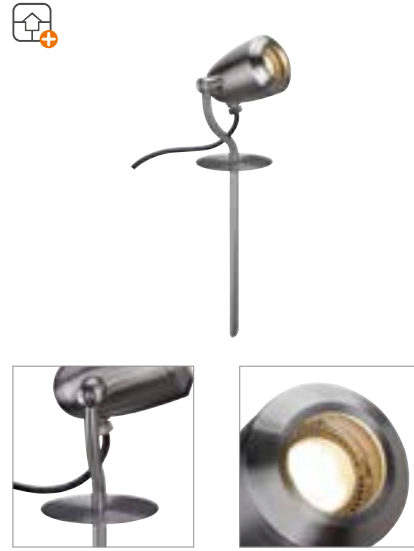

• Edelstahl 304

Produktangaben

230V ~50Hz
Material: Edelstahl 304

Maßzeichnung

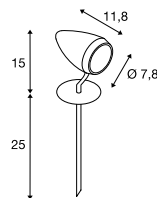

Hinweis

IP-Schutzkontaktstecker
Erdspieß inkl.

Leuchtmittlempfehlung

LED GU10 3,7W 36°
2700K 260lm EEK=A+
4kWh/1000h
Art. Nr. 560122

Leuchtmittelangaben

max. 4W LED GU10 51mm
Ø: 5 cm max. L: 5,7 cm max.

Variante	Art. Nr.
GU10 LED GU10 51mm ■ matt edelstahl	231672

CV SPOT
SP, long

A-A++ Spektrum A++-E



• Edelstahl 304

Produktangaben

230V ~50Hz
Material: Edelstahl 304

Maßzeichnung

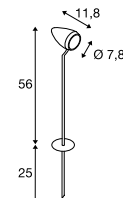

Hinweis

IP-Schutzkontaktstecker
Erdspieß inkl.

Leuchtmittlempfehlung

LED GU10 3,7W 36°
2700K 260lm EEK=A+
4kWh/1000h
Art. Nr. 560122

Leuchtmittelangaben

max. 4W LED GU10 51mm
Ø: 5 cm max. L: 5,7 cm max.

Variante	Art. Nr.
GU10 LED GU10 51mm ■ matt edelstahl	231682



229090 595

**NAUTILUS
SP, QR-C51****C-A+** Spektrum
A++-E

- Edelstahl 304

Produktangaben

12V ~50Hz
Material: Edelstahl 304 / Glas



IP 67

1

150

180°

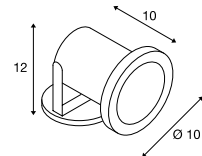
Maßzeichnung**Zubehörempfehlung**

■ Transformator 12V AC | 60VA IP44
Art. Nr. 227160

**Leuchtmittlempfehlung**

GU5.3 3,8W 40°
2700K 225lm EEK=A+
5kWh/1000h
Art. Nr. 551242



LED GU5.3 3,8W 40°
3000K 225lm EEK=A+
5kWh/1000h
Art. Nr. 551243

**Leuchtmittelangaben**

max. 35W QR-C51

Variante	Art. Nr.
GX5.3 QR-C51	
■ edelstahl	229090



229741 597

NAUTILUS 10 SPOT
SP, QPAR51



E-A++ Spektrum A++-E



• Edelstahl 316

Produktangaben

230V ~50Hz
Material: Edelstahl 316

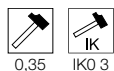

Maßzeichnung

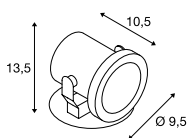

Hinweis

Passende Stecker und weiteres Zubehör finden Sie in unse em Zubehör Kapitel. Offenes Kabelend

Zubehörempfehlung

■ Verbindungsbox IP68, 3-polig
Art. Nr. 228730



Leuchtmittlempfehlung

GU10 4,3W 40°
3000K 245lm EEK=A+
5kWh/1000h
Art. Nr. 551253



LED GU10 5,6W 60°
2200-6700K 350lm EEK=A+
6kWh/1000h
Art. Nr. 1001919



Leuchtmittelangaben

max. 25W QPAR51
Ø: 5 cm max. L: 6 cm max.

Variante	Art. Nr.
GU10 QPAR51 ■ edelstahl	229741

NAUTILUS
SP



A-A++ Spektrum A++-E



• Edelstahl 316

Produktangaben

220-240V ~50/60Hz
Systemleistung: 9W
Material: Edelstahl 316

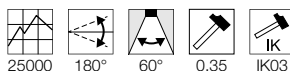
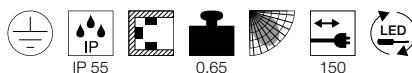

Maßzeichnung

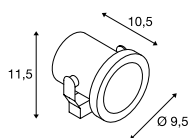

Hinweis

IP-Schutzkontaktstecker

Zubehörempfehlung

■ Montage Platte
Art. Nr. 1001963
■ Erdspließ Kunststoff
Art. Nr. 900011



NAUTILUS SPOT
SP, PAR38, E27



D-A+ Spektrum A++-E

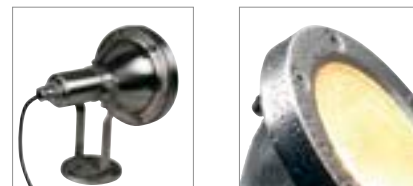

• Edelstahl 304

Produktangaben

230V ~50Hz
Material: Edelstahl 304

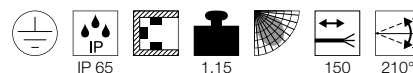

Maßzeichnung

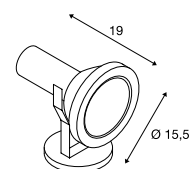

Hinweis

Passende Stecker und weiteres Zubehör finden Sie in unse em Zubehör Kapitel. Offenes Kabelend

Zubehörempfehlung

■ Verbindungsbox IP68, 3-polig
Art. Nr. 228730



Leuchtmittlempfehlung

E27 17W 45°
3000K 1430lm EEK=A+
17kWh/1000h
Art. Nr. 560473



Leuchtmittelangaben

max. 80W PAR38
optional: QPAR30

Variante	Art. Nr.
E27 PAR38 ■ edelstahl	229100

DASAR® PROJECTOR
SP, 12/24V



Produktangaben

12V/24V DC
Material: Edelstahl 316 / Glas

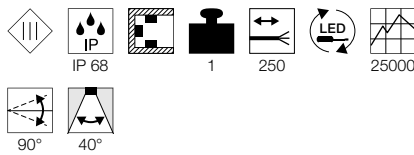

Maßzeichnung

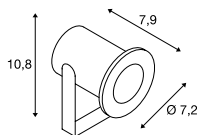

Hinweis

Genügend Platz für das empfohlene Netzteil bietet die Verbindungsbox 229269, siehe Zubehör Kapitel.
Offenes Kabelend

Zubehörempfehlung

- LED Netzteil 24V DC | 12W
Art. Nr. 470502
- LED Netzteil 12V DC | 12W
Art. Nr. 470507
- Erdspeiß Edelstahl 316
Art. Nr. 233580
- Montageplatte Edelstahl 316
Art. Nr. 233582
- Erdspeiß Kunststoff
Art. Nr. 900011

Variante	Art. Nr.
360lm 3000K CRI>80 ■ edelstahl	233570

DASAR® PROJECTOR
SP, 230V



Produktangaben

220-240V ~50/60Hz | 400mA
Systemleistung: 5,5W
Material: Edelstahl 316 / Glas

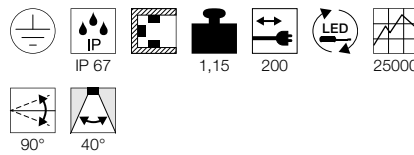

Maßzeichnung

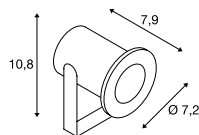

Hinweis

IP-Schutzkontaktstecker

Zubehörempfehlung

- Erdspeiß Edelstahl 316
Art. Nr. 233580
- Montageplatte Edelstahl 316
Art. Nr. 233582
- Erdspeiß Kunststoff
Art. Nr. 900011

Variante	Art. Nr.
300lm 3000K CRI>80 ■ edelstahl	233571

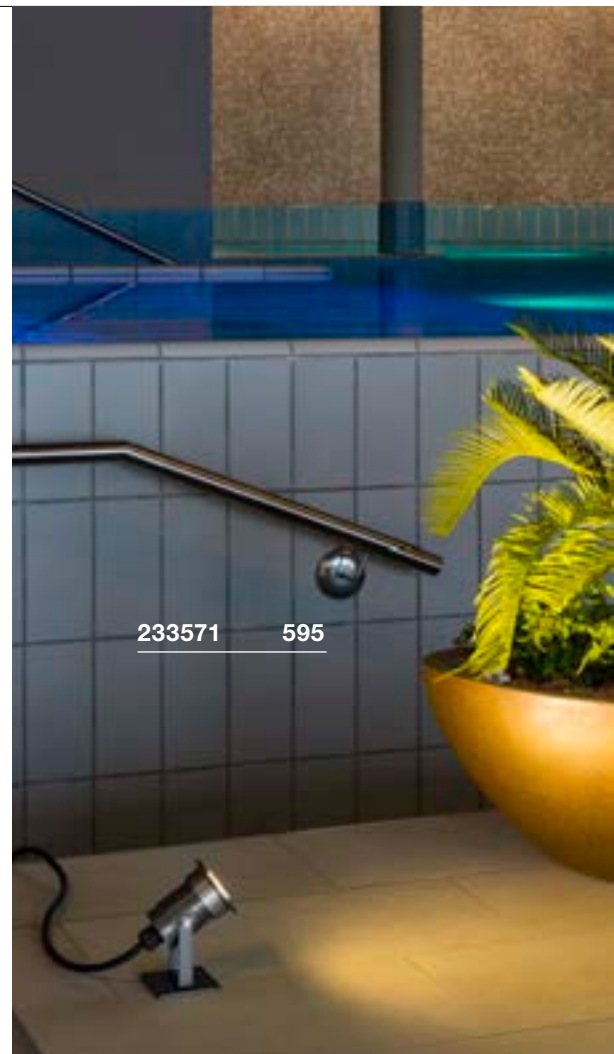



1000735 599



1000735 599

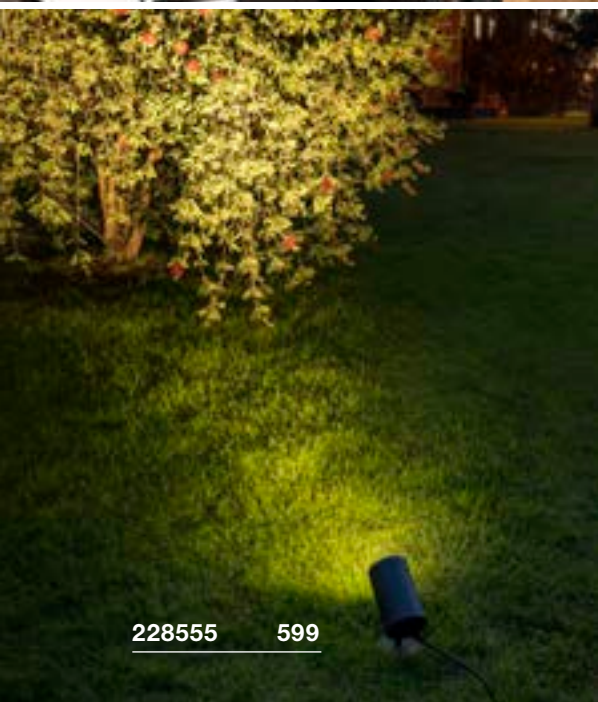

228555 599

HELIA SPOT S
SP, single, TRIAC



A-A++ Spektrum A++-E



HELIA SPOT L
SP, single, TRIAC



A-A++ Spektrum A++-E



• Hochvolt LED

Produktangaben

220-240V ~50/60Hz
Systemleistung: 8W
Material: Aluminium
Dimmbar: Triac C, Triac L

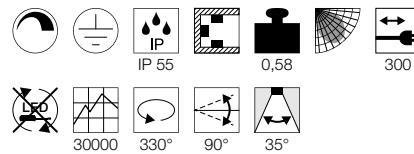

Maßzeichnung

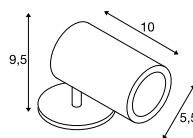

Hinweis

IP-Schutzkontaktstecker

Zubehörempfehlung

■ Erdspeiß
Art. Nr. 1000736

Variante	Art. Nr.
480lm 3000K CRI>80 ■ anthrazit	1000735

Produktangaben

220-240V ~50/60Hz
Systemleistung: 17W
Material: Aluminium / Glas
Dimmbar: Triac C, Triac L

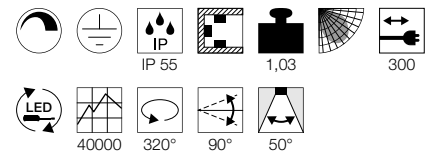

Maßzeichnung

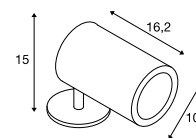

Hinweis

IP-Schutzkontaktstecker

Zubehörempfehlung

■ Erdspeiß
Art. Nr. 228560

Variante	Art. Nr.
1050lm 3000K CRI>80 ■ anthrazit	228555

SPOODI 15
SPA-A++ Spektrum
A++-ELED
INSIDE

Produktangaben

230V ~50Hz
Systemleistung: 10W
Material: Aluminium / Glas

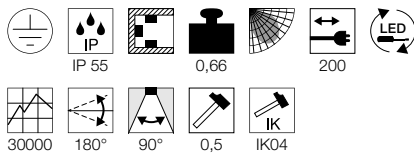

Maßzeichnung

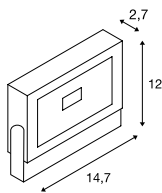

Hinweis

IP-Schutzkontaktstecker

Zubehörempfehlung

■ Erdspeiß Kunststoff
Art. Nr. 900011

■ Wandhalterung 50 cm
Art. Nr. 234340

■ Wandhalterung 80 cm
Art. Nr. 234350



Variante	Art. Nr.
760lm 3000K CRI>80	
■ schwarz	232800
830lm 4000K CRI>80	
■ schwarz	232810



232800 600



232820 601

SPOODI 20
SPA-A++ Spektrum
A++-ELED
INSIDE

Produktangaben

230V ~50Hz
Systemleistung: 30W
Material: Aluminium / Glas

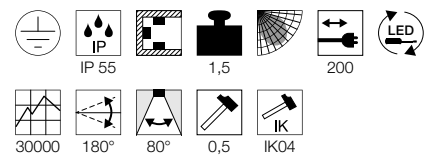

Maßzeichnung

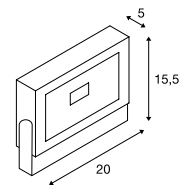

Hinweis

IP-Schutzkontaktstecker

Zubehörempfehlung

■ Erdspeiß Kunststoff

Art. Nr. 900011

■ Wandhalterung 50 cm

Art. Nr. 234340

■ Wandhalterung 80 cm

Art. Nr. 234350



Variante	Art. Nr.
2365lm 3000K CRI>80	
■ schwarz	232820
2680lm 4000K CRI>80	
■ schwarz	232830



232850

603

LOUNGE
VVCCID

SPOODI 31 SP

A-A++ Spektrum A++-E



SPOODI 13 SP, SENSOR

A-A++ Spektrum A++-E



SPOODI 20 SP, SENSOR

A-A++ Spektrum A++-E



- Integrierter Infrarot-Sensor
- Komfortable Sensoreinstellung über Fernbedienung

- Integrierter Infrarot-Sensor
- Komfortable Sensoreinstellung über Fernbedienung

Produktangaben

230V ~50Hz
Systemleistung: 60W
Material: Aluminium / Glas

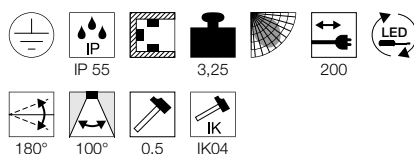

Produktangaben

220-240V ~50/60Hz
Systemleistung: 11W
Material: Aluminium / Glas

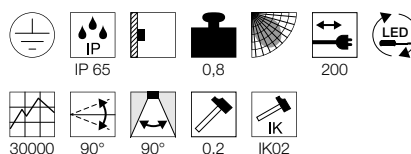

Produktangaben

220-240V ~50/60Hz
Systemleistung: 30W
Material: Aluminium / Glas

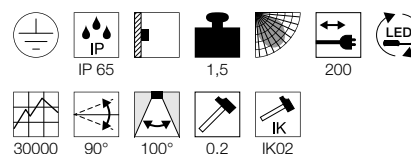

Maßzeichnung

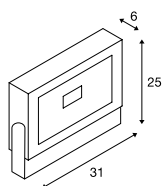

Maßzeichnung

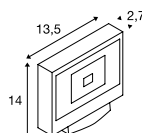

Maßzeichnung

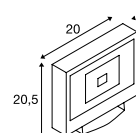

Hinweis

IP-Schutzkontaktstecker

Hinweis

Erfassungswinkel 110°, max. Erfassungsdistanz 8m, Tag/Nachtmodus, Einschaltdauer einstellbar
IP-Schutzkontaktstecker
Fernbedienung inkl.

Hinweis

Erfassungswinkel 110°, max. Erfassungsdistanz 8m, Tag/Nachtmodus, Einschaltdauer einstellbar
IP-Schutzkontaktstecker
Fernbedienung inkl.

Zubehörempfehlung

- Wandhalterung 50cm
Art. Nr. 234340
- Wandhalterung 80cm
Art. Nr. 234350



Variante	Art. Nr.
5100lm 3000K CRI>80 ■ schwarz	232840
5500lm 4000K CRI>80 ■ schwarz	232850

Variante	Art. Nr.
800lm 3000K CRI>80 ■ schwarz	232860
800lm 3000K CRI>80 ■ grau / transparent	232864
870lm 4000K CRI>80 ■ schwarz	232870
870lm 4000K CRI>80 ■ grau / transparent	232874

Variante	Art. Nr.
2250lm 3000K CRI>80 ■ schwarz	232880
2250lm 3000K CRI>80 ■ grau / transparent	232884
2500lm 4000K CRI>80 ■ schwarz	232890
2500lm 4000K CRI>80 ■ grau / transparent	232894

OUTDOOR BEAM 11
SP

A-A++ Spektrum A++-E

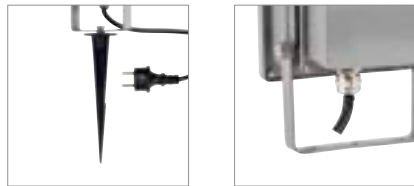

OUTDOOR BEAM 22
SP

A-A++ Spektrum A++-E



Produktangaben

220-240V ~50/60Hz | 120mA
Systemleistung: 11W
Material: Aluminium / Glas

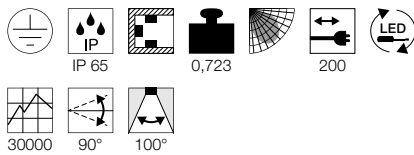

Maßzeichnung

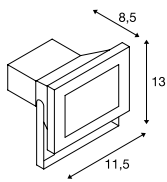

Hinweis

IP-Schutzkontaktstecker

Zubehörempfehlung

- Erdspieß Kunststoff
Art. Nr. 900011
- Wandhalterung 50 cm
Art. Nr. 234344
- Wandhalterung 80 cm
Art. Nr. 234354

Variante	Art. Nr.
800lm 5700K CRI>80 ■ grau / transparent	1001633
725lm 3000K CRI>80 ■ grau / transparent	1001634

Produktangaben

220-240V ~50/60Hz | 760mA
Systemleistung: 32W
Material: Aluminium / Glas

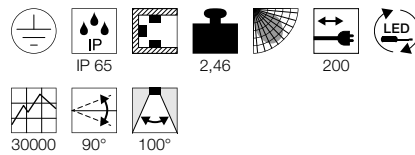

Maßzeichnung

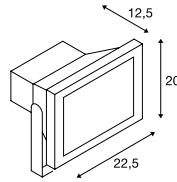

Hinweis

IP-Schutzkontaktstecker

Zubehörempfehlung

- Erdspieß Kunststoff
Art. Nr. 900011
- Wandhalterung 50 cm
Art. Nr. 234344
- Wandhalterung 80 cm
Art. Nr. 234354

Variante	Art. Nr.
2900lm 5700K CRI>80 ■ grau / transparent	1001635
2900lm 3000K CRI>80 ■ grau / transparent	1001636

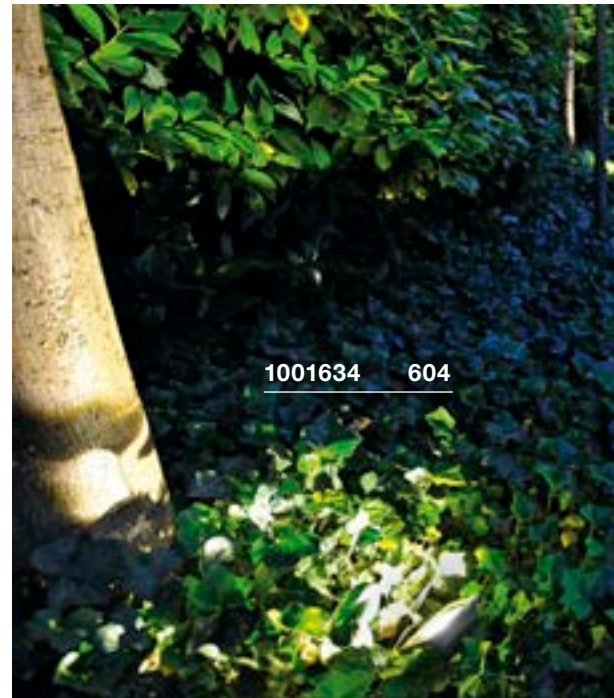



OUTDOOR BEAM 28 SP

A-A++ Spektrum A++-E

LED INSIDE



Produktangaben

220-240V ~50/60Hz | 640mA
Systemleistung: 54W
Material: Aluminium / Glas

Maßzeichnung

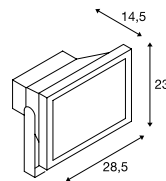

Hinweis

IP-Schutzkontaktstecker

Zubehöreffehlung

- Wandhalterung 50 cm
Art. Nr. 234344
- Wandhalterung 80 cm
Art. Nr. 234354

Variante	Art. Nr.
5100lm 5700K CRI>80 ■ grau / transparent	1001637
5100lm 3000K CRI>80 ■ grau / transparent	1001638

231072 605

FLAC BEAM® SP

A-A++ Spektrum A++-E

LED INSIDE



Produktangaben

220-240V ~50/60Hz
Material: Aluminium

Maßzeichnung

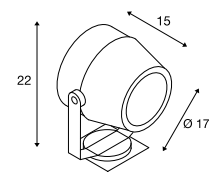

Hinweis

IP-Schutzkontaktstecker

Variante	Art. Nr.
1250lm 3000K CRI>80 18W ■ grau	231092
1800lm 3000K CRI>80 27W ■ grau	231072

FLOOD LIGHT 25 SP

A-A++ Spektrum A++-E



FLOOD LIGHT 32 SP

A-A++ Spektrum A++-E



Produktangaben

220-240V ~50/60Hz | 760mA
Systemleistung: 32W
Material: Aluminium / Glas

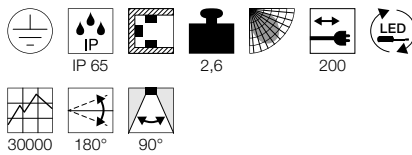

Produktangaben

220-240V ~50/60Hz | 1150mA
Systemleistung: 81W
Material: Aluminium / Glas

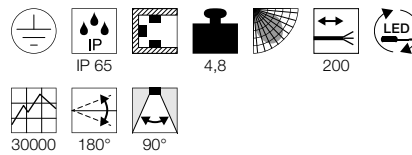

Maßzeichnung

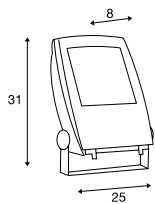

Maßzeichnung

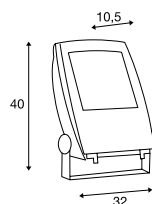

Hinweis

IP-Schutzkontaktstecker

Hinweis

Offenes Kabelend

Zubehörempfehlung

- Erdspieß Kunststoff
Art. Nr. 900011
- Wandhalterung 50 cm
Art. Nr. 234340
- Wandhalterung 80 cm
Art. Nr. 234350



Zubehörempfehlung

- Wandhalterung 50 cm
Art. Nr. 234340
- Wandhalterung 80 cm
Art. Nr. 234350
- Verbindungsbox IP68, 3-polig
Art. Nr. 228730



Variante	Art. Nr.
2350lm 5700K CRI>80 ■ matt schwarz	1001642
2200lm 3000K CRI>80 ■ matt schwarz	1001643

Variante	Art. Nr.
7200lm 5700K CRI>80 ■ matt schwarz	1001644
6300lm 3000K CRI>80 ■ matt schwarz	1001645





234205 607



234215 607

WILRON S SP

A-A++ Spektrum A++-E



Produktangaben

100-277V ~50/60Hz | 500mA
Systemleistung: 20W
Material: Aluminium / Glas

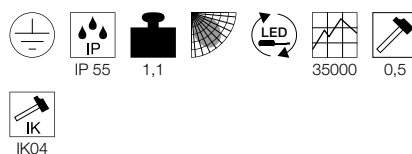

Maßzeichnung

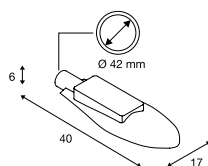

Hinweis

Zur Montage wird die Wandhalterung [234225] benötigt.
Zur Montage an Fassadenecken wird die Wandhalterung [234245] benötigt.
Die Leuchte ist geeignet für einen Stutzen mit 40mm Durchmesser

Zubehörempfehlung

- Wandhalterung Art. Nr. 234225
- Eckwandhalter Art. Nr. 234245

Variante	Art. Nr.
2010lm 4000K CRI>80 ■ anthrazit	234205

WILRON L SP

A-A++ Spektrum A++-E



Produktangaben

220-240V ~50/60Hz | 1500mA
Systemleistung: 65W
Material: Aluminium / Glas

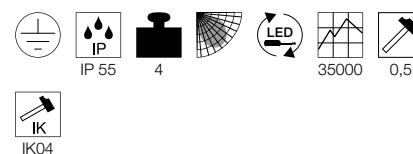

Maßzeichnung

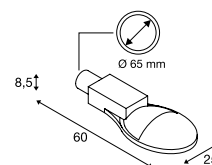

Hinweis

Zur Montage wird die Wandhalterung [234235] benötigt.
Zur Montage an Fassadenecken wird die Wandhalterung [234255] benötigt.
Die Leuchte ist geeignet für einen Stutzen mit 60mm Durchmesser

Zubehörempfehlung

- Wandhalterung Art. Nr. 234235
- Eckverbinder Art. Nr. 234255

Variante	Art. Nr.
5900lm 4000K CRI>80 ■ anthrazit	234215

VANO WING SP, 1-10V

A-A++ Spektrum
A++-E

LED
INSIDE



- Asymmetrische Lichtverteilung
- Gleichmäßige Ausleuchtung von vertikalen Flächen

Produktangaben

120-277V ~50/60Hz | 525mA
Material: Aluminium / Glas
Dimmbar: 1-10V

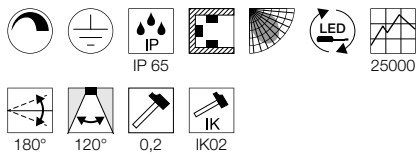

Maßzeichnung

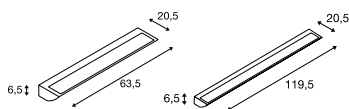

Variante	Art. Nr.
1500lm 3000K CRI>80 35W B: 63,5 cm 3,29 kg ■ grau / transparent	227734
3340lm 3000K CRI>80 48W B: 119,5 cm 6 kg ■ grau / transparent	227744



227734 608



227744 608



229482 609



229482 609

GALEN SP, TRIAC

A-A++ Spektrum A++-E

LED INSIDE



- Hochvolt LED
- IP - Steckverbinder

Produktangaben

220-240V ~50/60Hz
 Systemleistung: 18W
 Material: Aluminium / Glas
 Dimmbar: Triac C, Triac L

Maßzeichnung

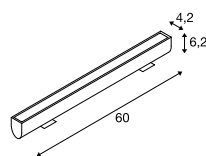

GALEN 100 SP

A-A++ Spektrum A++-E

LED INSIDE



Produktangaben

24V DC
 Systemleistung: 25W
 Material: Aluminium / Glas

Maßzeichnung

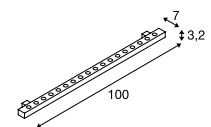

Hinweis

Offenes Kabelend

Zubehörempfehlung

- Anschlussleitung 500 cm
Art. Nr. 231960
- Verbindungskabel 100 cm
Art. Nr. 231961



Zubehörempfehlung

- LED Netzteil 24V DC | 36W
Art. Nr. 470544
- LED Netzteil 24V DC | 60W
Art. Nr. 470506



Variante	Art. Nr.
850lm 3000K CRI>80	
■ grau / matt transparent	231954
850lm 3000K CRI>80	
■ anthrazit	231955

Variante	Art. Nr.
1070lm 6500K CRI>70	
■ grau / transparent	229481
970lm 3000K CRI>70	
■ grau / transparent	229482

BRINGEN LICHT INS DUNKEL.

PRAKTISCHE WAND- UND DECKENLEUCHTEN.

Die strahlen sogar noch bei den schlechtesten Wetterverhältnissen: Unsere Wand- und Deckenleuchten sind robust, energieeffizient und leistungsstark. Neben all der Funktionalität können Sie aber auch noch zwischen verschiedenen Designs auswählen. Soll es eher modern sein? Traditionell? Rund? Oder lieber eckig?





232457 658

















































































LAKE COMO
RESIDENCE



1002900 660

WAND- UND DECKENLEUCHTEN

							
614	614	614	616	617	618	618	619
							
619	620	620	620	622	623	624	625
							
626	627	627	628	629	629	629	630
							
631	632	632	633	633	634	635	636
							
637	637	638	639	639	639	640	640
							
641	641	641	642	643	643	644	644

 645	 645	 646	 646	 647	 648	 649	 649
 650	 650	 651	 652	 653	 653	 654	 654
 654	 655	 655	 656	 656	 657	 657	 658
 658	 659	 660	 661	 661	 662	 663	 663
 664	 665	 665	 666	 666	 668	 668	 669
 670	 670	 670	 671	 671	 672	 672	 673
 674	 675	 675	 675	 676	 676	 676	 677
 677	 678	 678	 678	 679	 680	 680	 681
 681	 682	 682	 683	 684	 684	 684	 687
 687	 687	 688	 689	 689	 689	 690	 690
 690	 691	 691					

PHOTONIA
WL, E27



E-A++ Spektrum A++-E



GLOO PURE
WL, E27



E-A++ Spektrum A++-E



MOLAT
WL, E27



E-A++ Spektrum A++-E

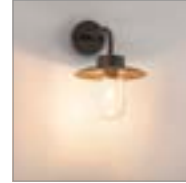

Produktangaben

220-240V ~50/60Hz
Material: Aluminium / Glas

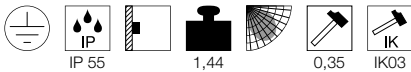

Produktangaben

230V ~50Hz
Material: Aluminium / Glas



Produktangaben

230V ~50/60Hz
Material: Aluminium / Glas



Maßzeichnung

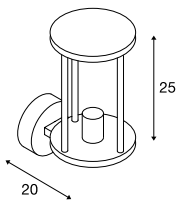

Maßzeichnung

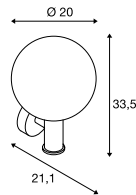

Maßzeichnung

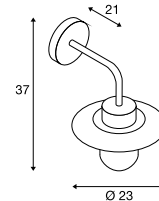

Leuchtmittlempfehlung

E27 5W 330°
2000K 500lm EEK=A+
5kWh/1000h
Art. Nr. 560741



LED E27 7W 280°
2700K 790lm EEK=A++
7kWh/1000h
Art. Nr. 1002127



Leuchtmittlempfehlung

E27 4,7W 360°
3000K 380lm EEK=A+
5kWh/1000h
Art. Nr. 551532



LED E27 12W 240°
3000K 1055lm EEK=A+
12kWh/1000h
Art. Nr. 1001032



Leuchtmittlempfehlung

LED E27 4,8W 330°
2700K 470lm EEK=A++
5kWh/1000h
Art. Nr. 560752



LED E27 5W 330°
2000K 500lm EEK=A+
5kWh/1000h
Art. Nr. 560741



Leuchtmittelangaben

max. 60W
Ø: 9 cm max. L: 15 cm max.

Leuchtmittelangaben

max. 23W
Ø: 4,8 cm max. L: 18 cm max.

Leuchtmittelangaben

max. 60W
Ø: 6,5 cm max. L: 14,5 cm max.

Variante	Art. Nr.
E27	
■ anthrazit	232045

Variante	Art. Nr.
E27	
■ anthrazit / matt transparent	1002002

Variante	Art. Nr.
E27	
■ anthrazit	1000820

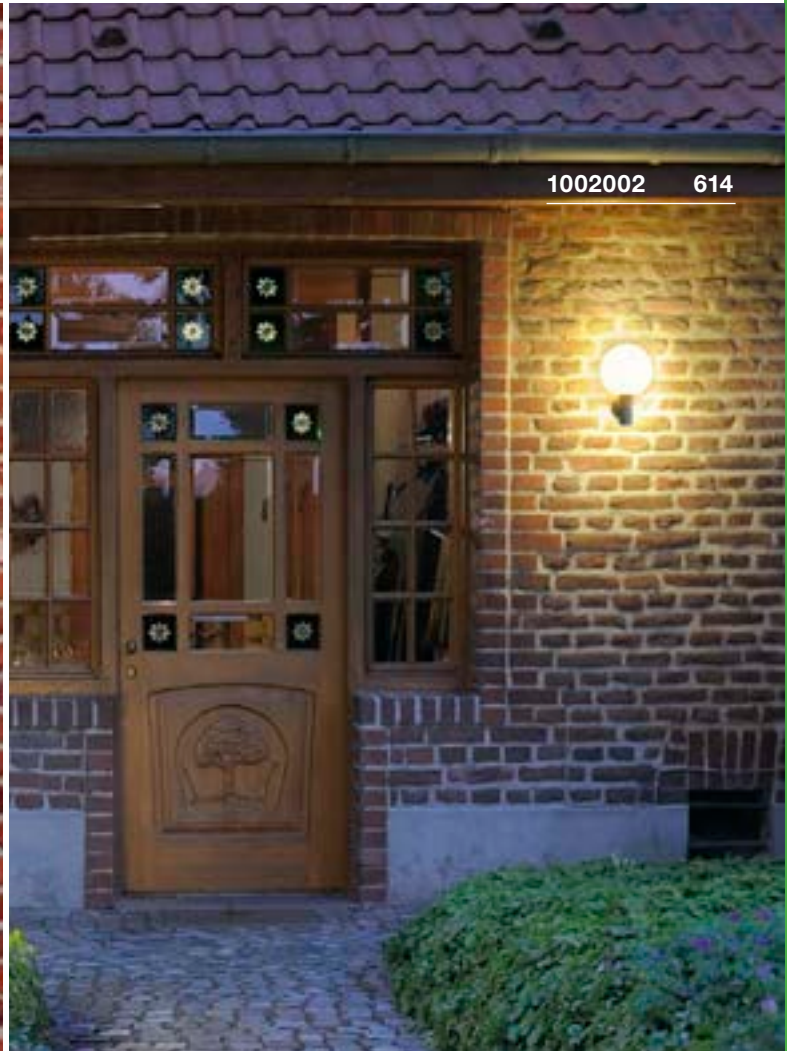
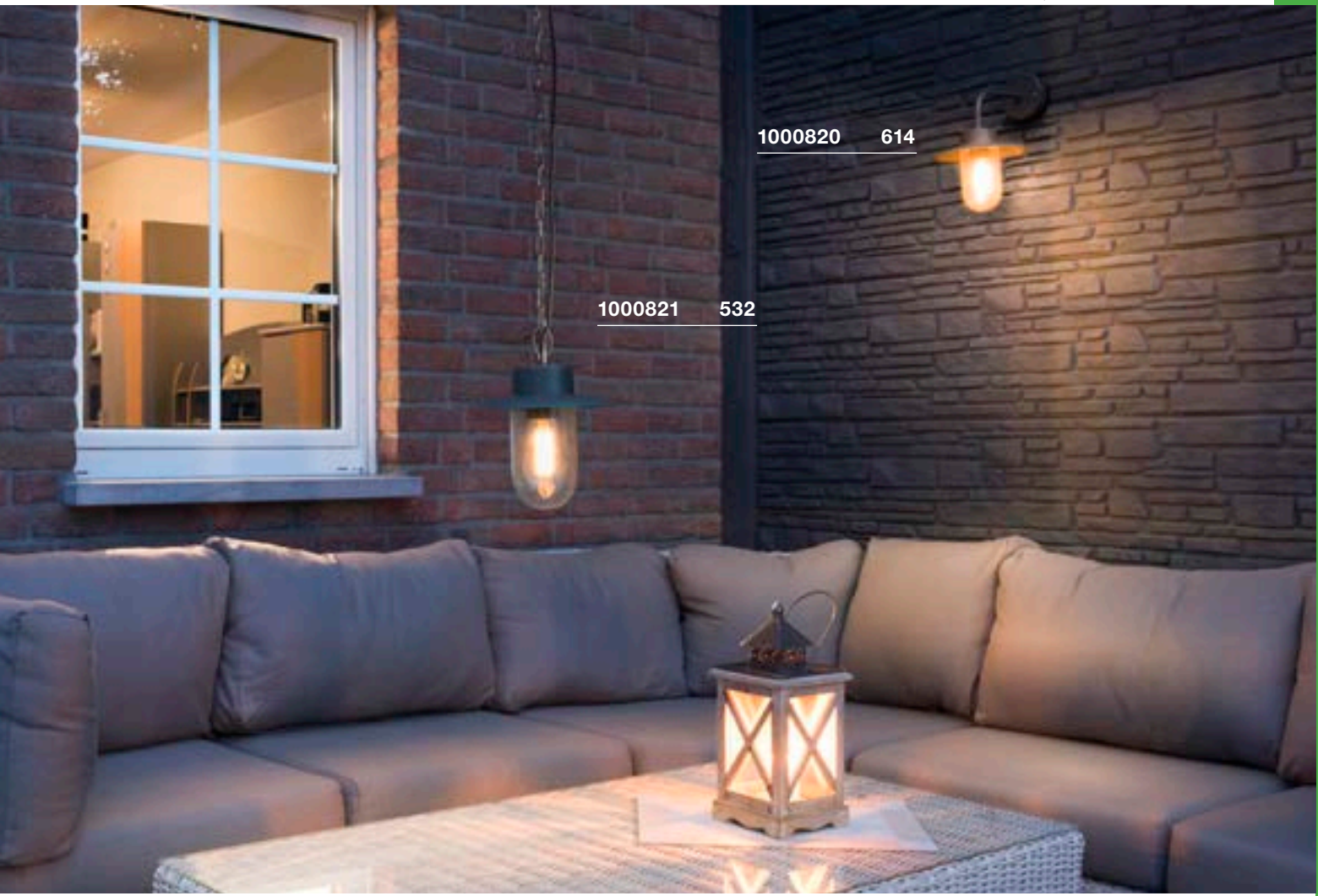

SLOTS
WL

896

A-A++ Spektrum
A++-ELED
INSIDE

Produktangaben

220-240V ~50/60Hz
Systemleistung: 6,3W
Material: Aluminium / Glas

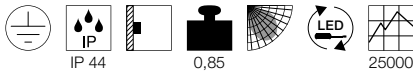

Maßzeichnung

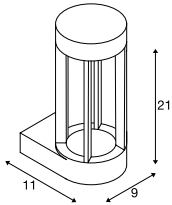

Variante	Art. Nr.
140lm 3000K CRI>80	
■ anthrazit	231805
140lm 3000K CRI>80	
■ rost	231807

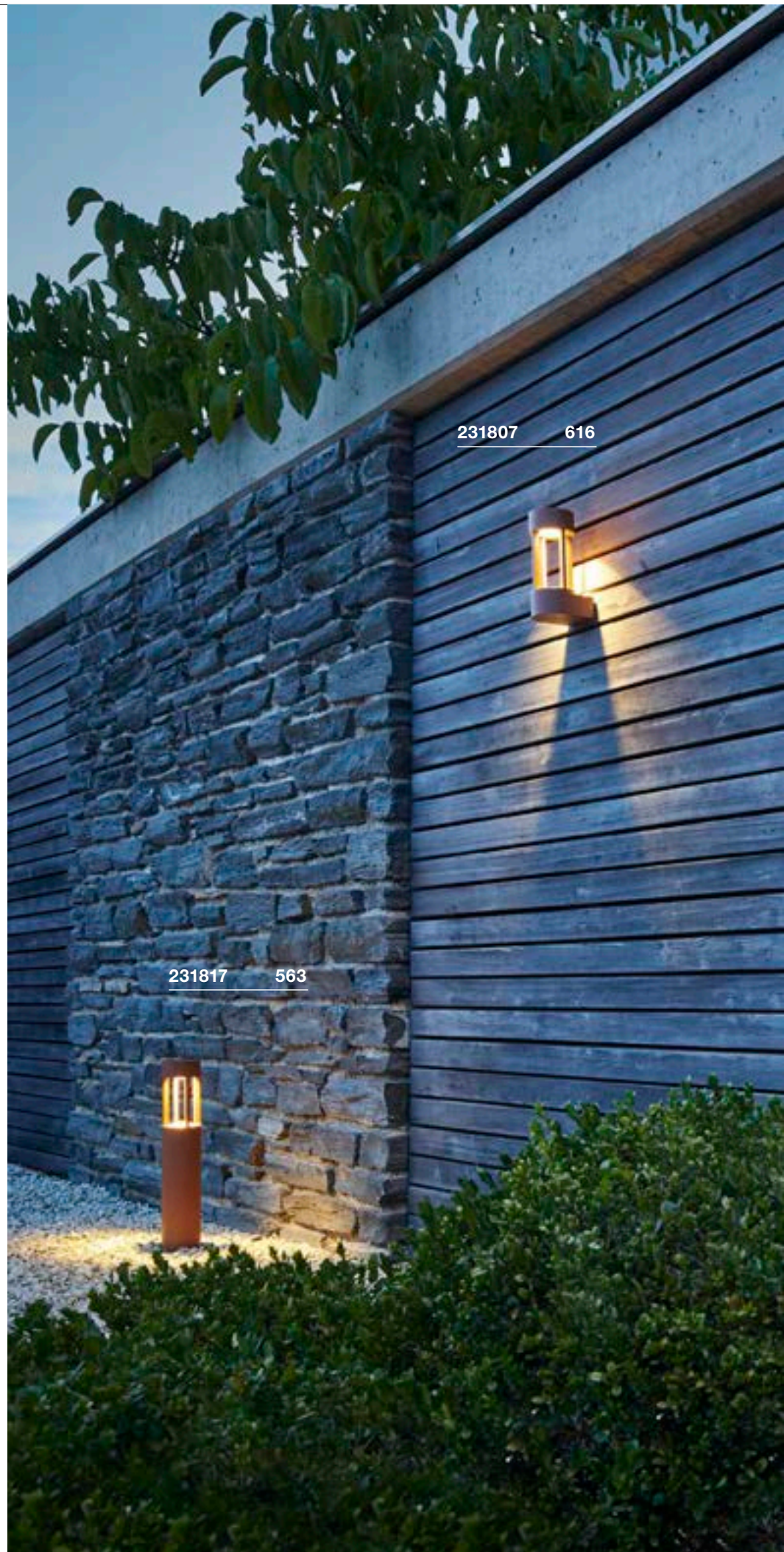

231807 616

231817 563



1000681 617

1000682 549

APONI
WL, TRIAC

883

A-A++ Spektrum
A++-E

LED
INSIDE



• Hochvolt LED

Produktangaben

220-240V ~50/60Hz
Systemleistung: 8W
Material: Aluminium
Dimmbar: Triac L

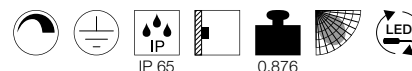

Maßzeichnung

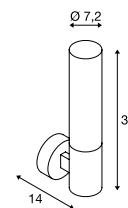

Variante	Art. Nr.
440lm 3000K CRI>80 ■ anthrazit	1000681

F-POL
WL, E27



C-POL
WL, E27



A-A++ Spektrum
A++-E

A-A++ Spektrum
A++-E



- Hochglanzreflek or für effektive Beleuchtung
- Diffuse Lichtverteilung zur Beleuchtung der Gebäudeumgebung

- Hochglanzreflek or für effektive Beleuchtung
- Diffuse Lichtverteilung zur Beleuchtung der Gebäudeumgebung

Produktangaben

230V ~50Hz
Material: Aluminium / Polycarbonat (PC)

Produktangaben

230V ~50Hz
Material: Aluminium / Polycarbonat (PC)

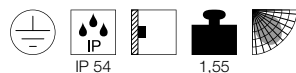
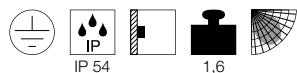

Maßzeichnung

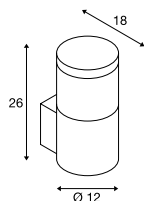

Maßzeichnung

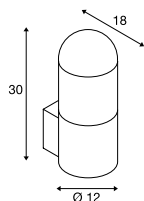

Leuchtmittlempfehlung

E27 12W 240°
3000K 1055lm EEK=A+
12kWh/1000h
Art. Nr. 1001032



Leuchtmittlempfehlung

E27 15W 240°
3000K 1521lm EEK=A+
15kWh/1000h
Art. Nr. 1001033



Leuchtmittelangaben

max. 20W
Ø: 5 cm max. L: 14 cm max.

Leuchtmittelangaben

max. 24W
Ø: 5,2 cm max. L: 17,3 cm max.

Variante	Art. Nr.
E27	
■ anthrazit	231585

Variante	Art. Nr.
E27	
■ anthrazit	231465



231585 618



231465 618



228120 + 1000449 619

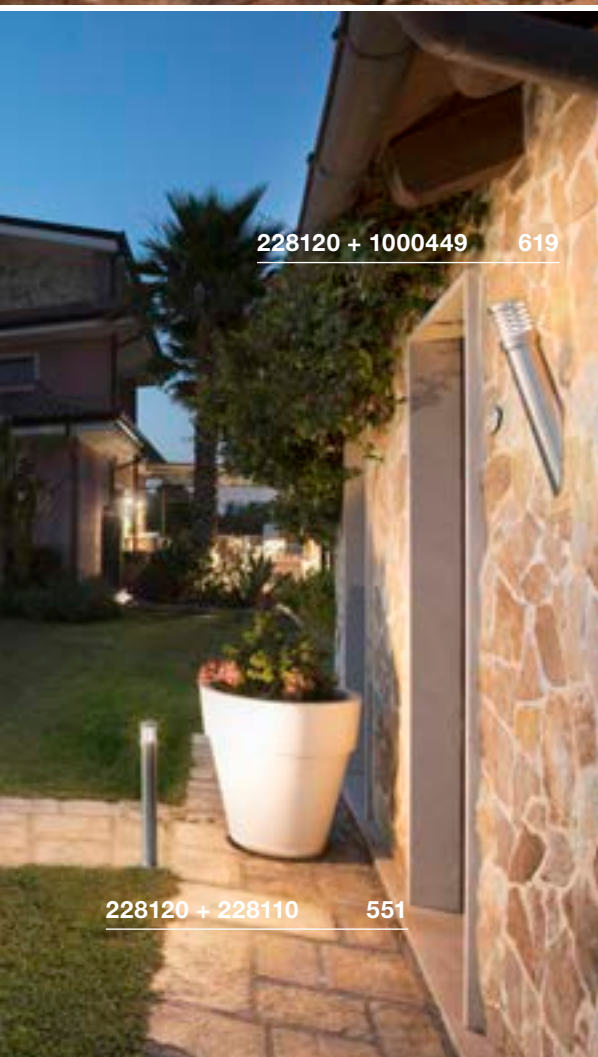

228120 + 1000449 619

228120 + 228110 551

TRUST
WL



A-A++ Spektrum A++-E

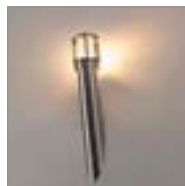

- Hochvolt LED
- Edelstahl 316

Produktangaben

220-240V ~50/60Hz
Systemleistung: 8,6W
Material: Edelstahl 316



Maßzeichnung

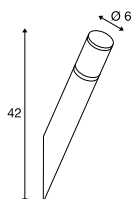

Zubehörempfehlung

- Verbindungsbox IP68, 3-polig
Art. Nr. 228730
- Raster ringförmig
Art. Nr. 228130
- Raster spiralförmig
Art. Nr. 1000449



Variante	Art. Nr.
400lm 3000K CRI>80	
■ edelstahl	228120

BIG NAILS
WL, E27



A-A++ Spektrum A++-E



- Edelstahl 304
- Schlankes Design, blendfreie Außenbeleuchtung

Produktangaben

230V ~50Hz
Material: Edelstahl 304 / Polycarbonat (PC)

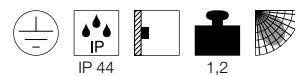

Maßzeichnung

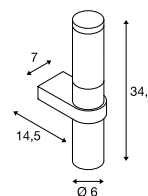

Leuchtmittlempfehlung

E27 4,7W 360°
3000K 380lm EEK=A+
5kWh/1000h
Art. Nr. 551532



LED E27 12W 240°
3000K 1055lm EEK=A+
12kWh/1000h
Art. Nr. 1001032



Leuchtmittelangaben

max. 15W
Ø: 4,5 cm max. L: 17 cm max.

Variante	Art. Nr.
E27	
■ edelstahl	229182

GRAFIT
WL, E27



A-A++ Spektrum A++-E



SQUARE
WL, E27



A-A++ Spektrum A++-E



SQUARE
WL, TRIAC



A-A++ Spektrum A++-E



- Leuchte aus hochwertigem 316 Edelstahl
- Modernes Design
- Diffuse Lichtverteilung zu Beleuchtung der Gebäudeumgebung

Produktangaben

230V ~50Hz
Material: Aluminium / Kunststoff

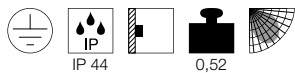

Produktangaben

220-240V ~50/60Hz
Material: Edelstahl 304



Produktangaben

220-240V ~50/60Hz
Systemleistung: 12W
Material: Edelstahl 316
Dimmbar: Triac C, Triac L

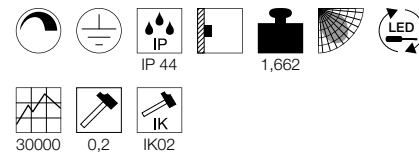

Maßzeichnung

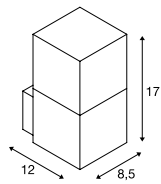

Maßzeichnung

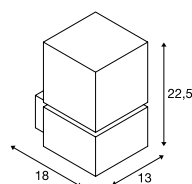

Maßzeichnung

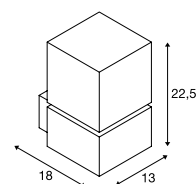

Leuchtmittelempfehlung

LED E27 7W 280°
2700K 790lm EEK=A++
7kWh/1000h
Art. Nr. 1002127



LED E27 6,8W 330°
2700K 806lm EEK=A++
7kWh/1000h
Art. Nr. 560762



Leuchtmittelempfehlung

LED E27 4,5W 280°
2700K 530lm EEK=A++
5kWh/1000h
Art. Nr. 1002123



LED E27 7W 280°
2700K 790lm EEK=A++
7kWh/1000h
Art. Nr. 1002124



Leuchtmittelangaben

max. 11W
Ø: 6 cm max. L: 11,5 cm max.

Leuchtmittelangaben

max. 20W
Ø: 7 cm max. L: 13 cm max.

Variante	Art. Nr.
E27 ■ anthrazit	231205

Variante	Art. Nr.
E27 ■ edelstahl	1000336

Variante	Art. Nr.
760lm 3000K CRI>80 ■ edelstahl	1000834

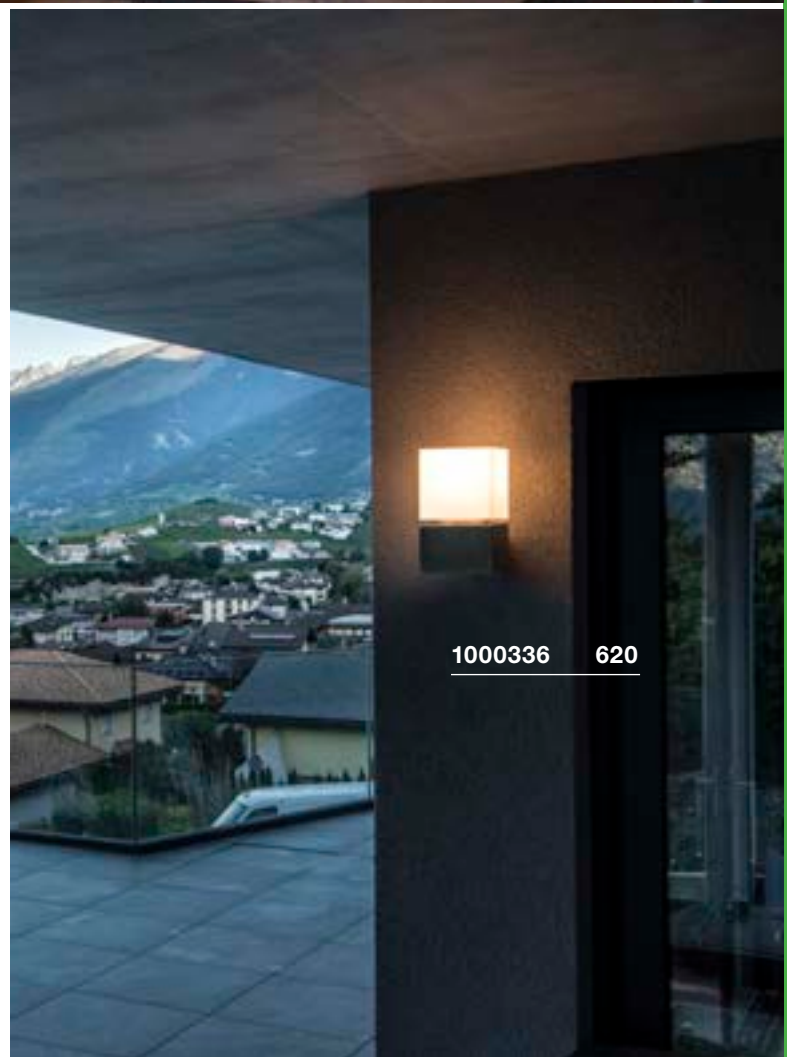

KERAS ELT
WL, E27A-A++ Spektrum
A++-E

- Ungewöhnliches Design

Produktangaben

230V ~50Hz
Material: Aluminium / Polycarbonat (PC)



IP 54

1,6

Maßzeichnung

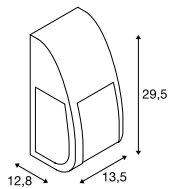

Leuchtmittlempfehlung

LED E27 14,5W 200°
2700K 1521lm EEK=A+
15kWh/1000h
Art. Nr. 560422



LED E27 9W 240°
2700-6500K 806lm EEK=A+
9kWh/1000h
Art. Nr. 1001916



Leuchtmittelangaben

max. 25W
Ø: 7 cm max. L: 17,5 cm max.

Variante	Art. Nr.
E27	
■ grau	227174
E27	
■ anthrazit	227176

227174 622



230445 623

MERIDIAN WL, E27

A-A++ Spektrum
A++-E

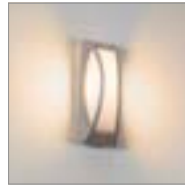

Produktangaben

230V ~50Hz

Material: Aluminium / Polycarbonat (PC)



IP 54



1,25



Maßzeichnung

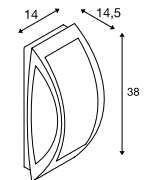

Leuchtmittlempfehlung

LED E27 9,1W 240°
2700K 760lm EEK=A+
10kWh/1000h

Art. Nr. 560402



LED E27 9W 240°
2700-6500K 806lm EEK=A+
9kWh/1000h

Art. Nr. 1001916



Leuchtmittelangaben

max. 25W

Ø: 7 cm max. L: 17,5 cm max.

Variante	Art. Nr.
E27	
■ grau	230444
E27	
■ anthrazit	230445

QUADRULO SENSOR WL, E27

E-A++ Spektrum
A++-E

NEW



Produktangaben

230V ~50Hz
Material: Aluminium / Glas

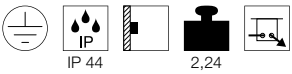

Maßzeichnung

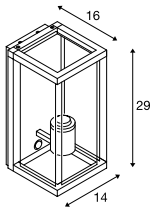

Leuchtmittlempfehlung

LED E27 4,5W 280°
2700K 530lm EEK=A++
5kWh/1000h
Art. Nr. 1002123



LED E27 5W 330°
2000K 500lm EEK=A+
5kWh/1000h
Art. Nr. 560741



Leuchtmittelangaben

max. 15W
Ø: 8 cm max. L: 18 cm max.

Variante	Art. Nr.
E27	
■ anthrazit	1002402

1002402 624



1002403 625

QUADRULO WL, E27

E-A++ Spektrum
A++-E

NEW



Produktangaben

230V ~50Hz
Material: Aluminium / Glas



IP 44



2,21



Maßzeichnung

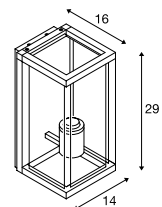

Leuchtmittelempfehlung

LED E27 4,5W 280°
2700K 530lm EEK=A++
5kWh/1000h
Art. Nr. 1002123



LED E27 5W 330°
2000K 500lm EEK=A+
5kWh/1000h
Art. Nr. 560741



Leuchtmittelangaben

max. 15W
Ø: 8 cm max. L: 18 cm max.

Variante	Art. Nr.
E27	
■ anthrazit	1002403

MERIDIAN BOX WL, E27

A-A++ Spektrum
A++-E



Produktangaben

230V ~50Hz

Material: Aluminium / Polycarbonat (PC)



IP 54

1,7

Maßzeichnung

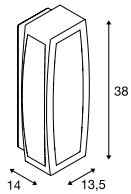

Leuchtmittelpfehlung

LED E27 7,1W 330°
2700K 806lm EEK=A+
8kWh/1000h

Art. Nr. 1001756



LED E27 5W 330°
2000K 500lm EEK=A+
5kWh/1000h

Art. Nr. 560741



Leuchtmittelangaben

max. 25W

Ø: 7 cm max. L: 17,5 cm max.

Variante	Art. Nr.
E27	
■ anthrazit	230655
E27	
■ rost	230657



230655

626

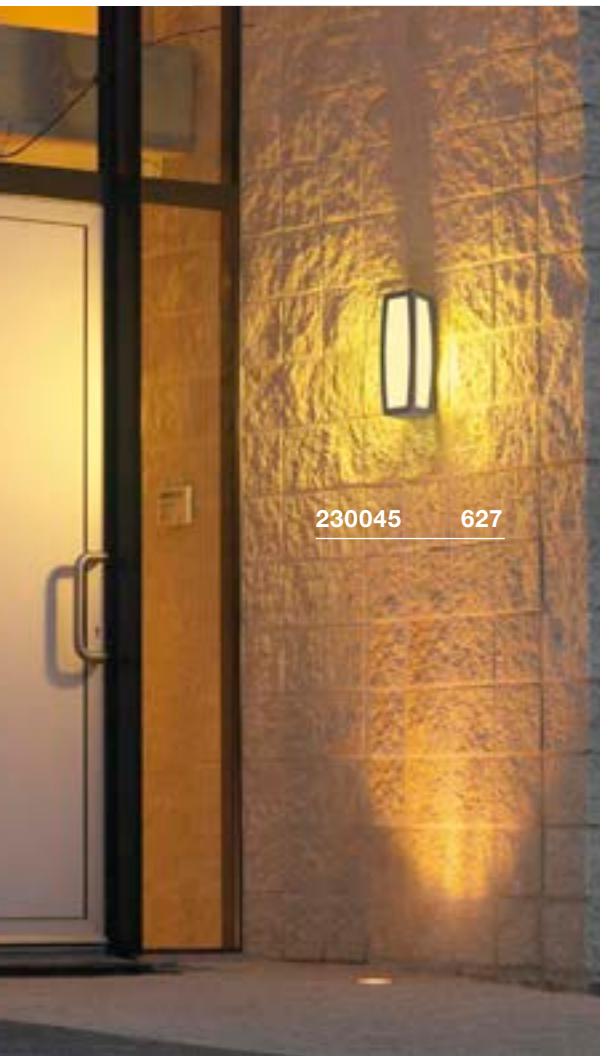

230045 627



230044 627

MERIDIAN BOX
WL, E27



Produktangaben

230V ~50Hz
Material: Aluminium / Polycarbonat (PC)

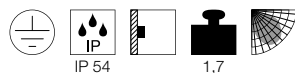

Maßzeichnung

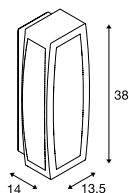

Leuchtmittlempfehlung

LED E27 7,1W 330°
2700K 806lm EEK=A+
8kWh/1000h
Art. Nr. 1001756



LED E27 5W 330°
2000K 500lm EEK=A+
5kWh/1000h
Art. Nr. 560741



Leuchtmittelangaben

max. 25W
Ø: 7 cm max. L: 17,5 cm max.

Variante	Art. Nr.
E27	
■ grau	230044
E27	
■ anthrazit	230045

MERIDIAN BOX
WL, E27, MR



Produktangaben

230V ~50Hz
Material: Aluminium / Polycarbonat (PC)

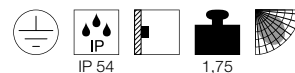

Maßzeichnung

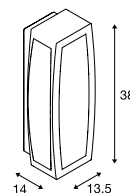

Hinweis

Bewegungsmelder: Erfassungswinkel: 180°
Erfassungsdistanz: 1-5 m
Die Einschaltungsschelligkeit und Einschaltdauer können eingestellt werden.

Leuchtmittlempfehlung

E27 9W 240°
3000K 810lm EEK=A+
10kWh/1000h
Art. Nr. 1001031



LED E27 12W 240°
3000K 1055lm EEK=A+
12kWh/1000h
Art. Nr. 1001032



Leuchtmittelangaben

max. 25W
Ø: 7 cm max. L: 17,5 cm max.

Variante	Art. Nr.
E27	
■ grau	230084
E27	
■ anthrazit	230085

ENOLA C
WL



A-A++ Spektrum
A++-E



228511 628

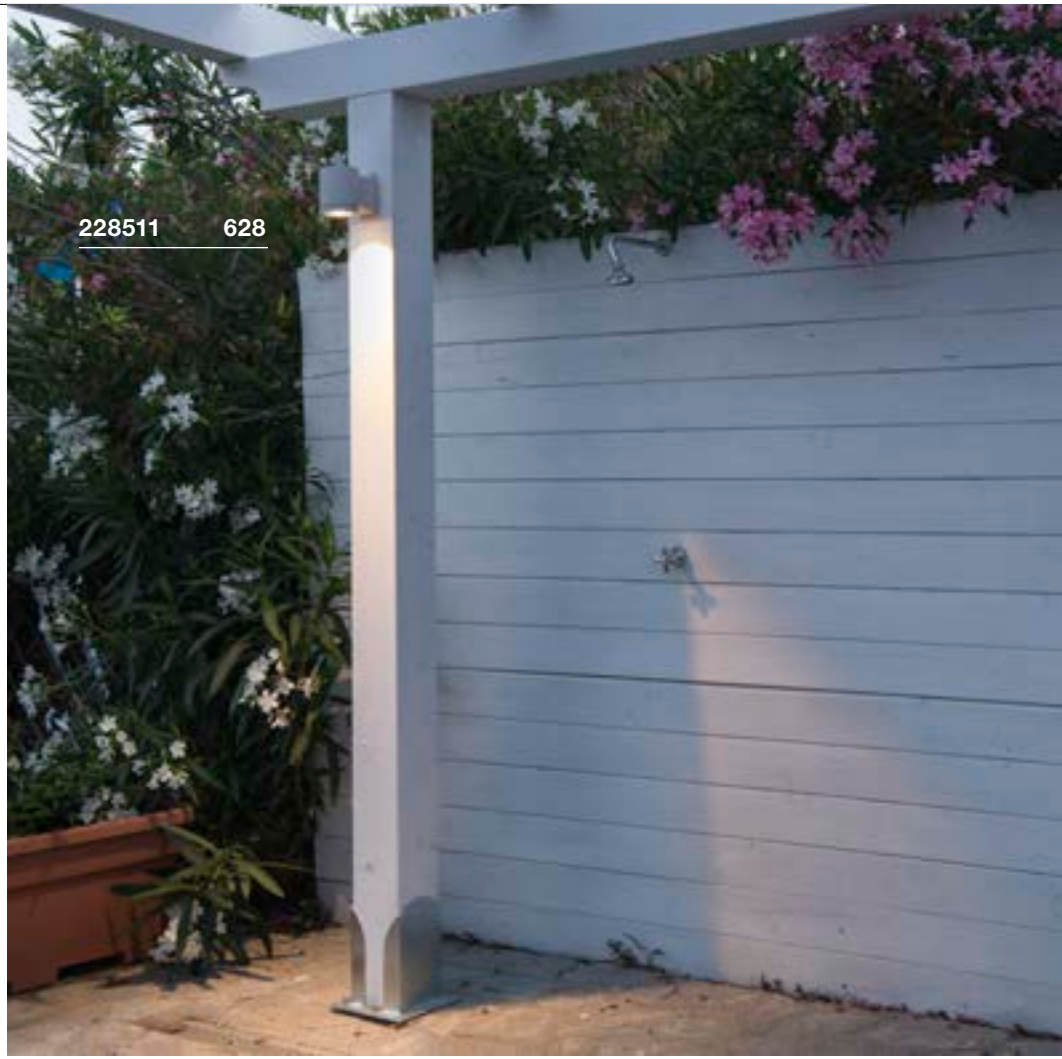

Produktangaben

100-240V ~50/60Hz | 500mA
Systemleistung: 12W
Material: Aluminium / Glas

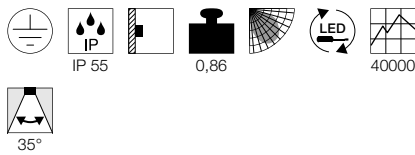

Maßzeichnung

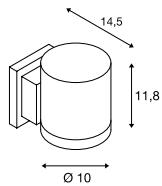

233255 629



Zubehörempfehlung

Aufbaumontage Rahmen

Art. Nr. 233211

Aufbaumontage Rahmen

Art. Nr. 233215



Variante	Art. Nr.
900lm 3000K CRI>80	
<input type="checkbox"/> weiß	228511
900lm 3000K CRI>80	
<input checked="" type="checkbox"/> anthrazit	228515

HELIA
WL, TRIAC



A-A++ Spektrum A++-E



• Hochvolt LED

Produktangaben

220-240V ~50/60Hz
Systemleistung: 8W
Material: Aluminium / Glas
Dimmbar: Triac C, Triac L

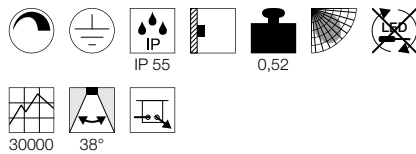

Maßzeichnung

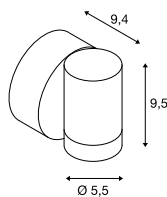

SITRA
WL, TCR-TSE



B-A++ Spektrum A++-E



Produktangaben

230V ~50Hz
Material: Aluminium / Glas

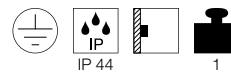

Maßzeichnung

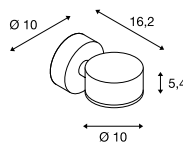

Leuchtmittelpfehlung

GX53 4,2W 35°
3000K 200lm EEK=A
5kWh/1000h
Art. Nr. 550092



LED GX53 7,5W 120°
4000K 620lm EEK=A+
8kWh/1000h
Art. Nr. 1001221



Leuchtmittelangaben

max. 9W TCR-TSE
Ø: 7,5 cm max. L: 3,5 cm max.

Variante	Art. Nr.
450lm 3000K CRI>80 ■ anthrazit	233225

Variante	Art. Nr.
GX53 TCR-TSE ■ anthrazit	230355

SITRA
WL



A-A++ Spektrum A++-E



Produktangaben

220-240V ~50/60Hz
Systemleistung: 9W
Material: Aluminium / Glas

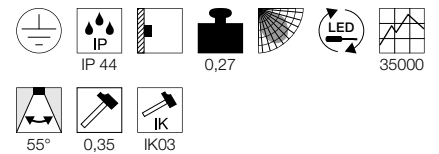

Maßzeichnung

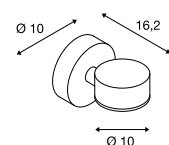

Variante	Art. Nr.
450lm 3000K CRI>80 ■ anthrazit	1002016
450lm 3000K CRI>80 □ weiß	1002017

ROX
WL, QPAR111

895

E-A++ Spektrum
A++-E

- Hochwertig gebürstete Oberfläche

Produktangaben230V ~50Hz
Material: Aluminium / Glas

IP 44

0,9

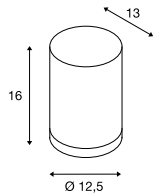
Maßzeichnung

1000333 630

LeuchtmittlempfehlungLED GU10 10W 38°
3000K 630lm EEK=A+
10kWh/1000h

Art. Nr. 1001029

LED GU10 13W 30°
4000K 1300lm EEK=A+
13kWh/1000h

Art. Nr. 1001243

**Leuchtmittelangaben**

max. 50W QPAR111

Variante	Art. Nr.
GU10 QPAR111	
gebürstet aluminium	1000333



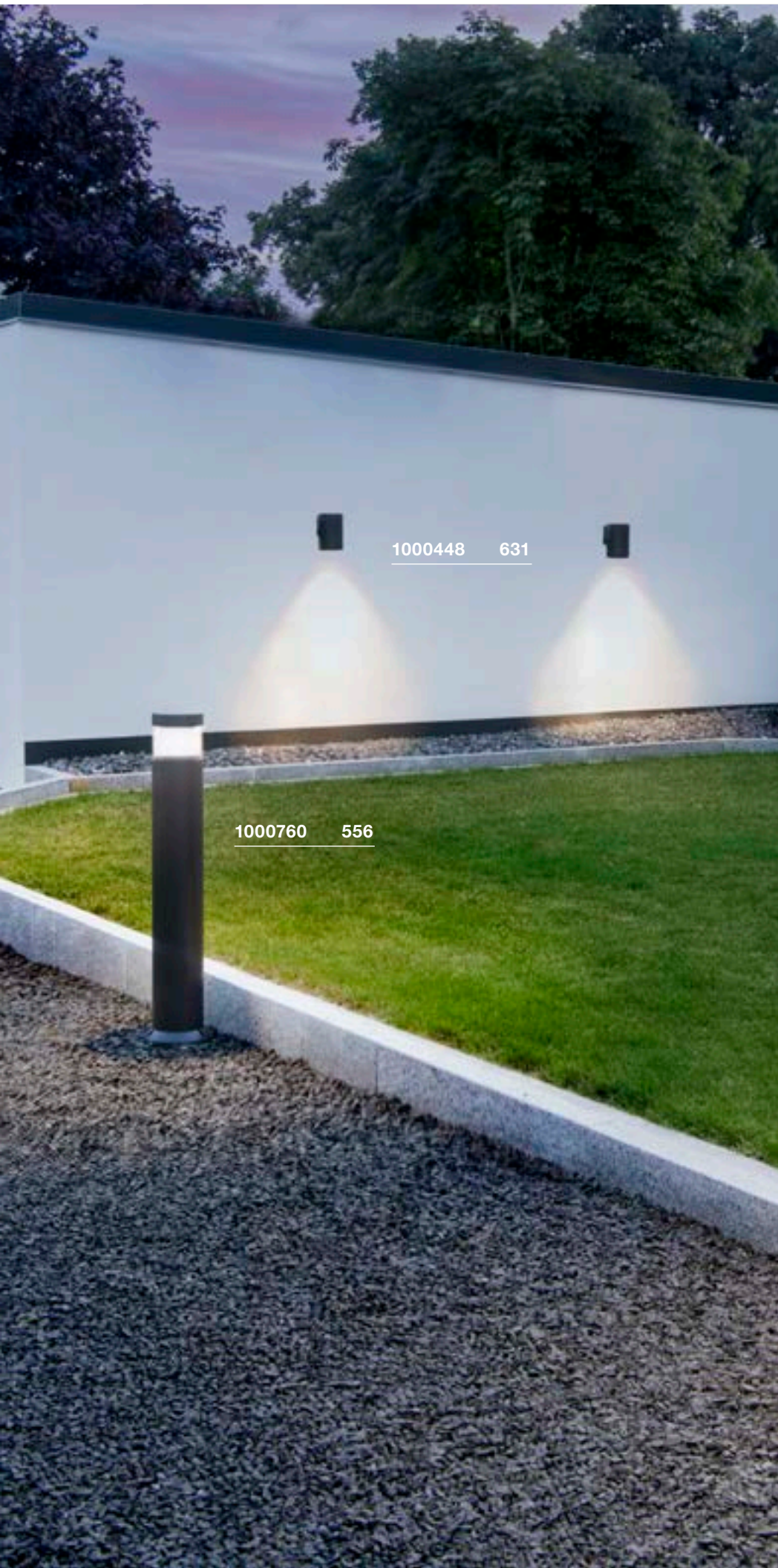

1000448 631

1000760 556

POLE PARC
WL

894

A-A++ Spektrum
A++-E

LED
INSIDE



- Ideal geeignet zur effektiven Ak-entwertung der Gebäudearchitektur
- Rotationssymmetrische Lichtverteilung

Produktangaben

100-240V ~50/60Hz | 700mA
Systemleistung: 28W
Material: Aluminium / Glas

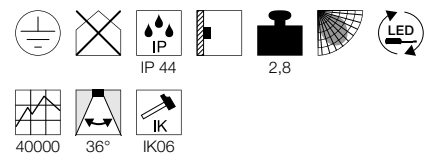

Maßzeichnung

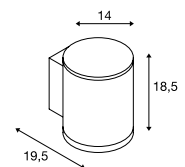

Variante	Art. Nr.
2900lm 3000K CRI>80 ■ anthrazit	1000448

DOWNUNDER OUT
Round



- Die Lichtfarbe ist bei der Installation durch einen Schalter einstellbar

Produktangaben

100-277V ~50/60Hz | 500mA
Systemleistung: 4,5W
Material: Aluminium



Maßzeichnung

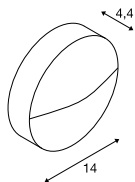

DOWNUNDER OUT
Square



- Die Lichtfarbe ist bei der Installation durch einen Schalter einstellbar

Produktangaben

100-277V ~50/60Hz | 500mA
Systemleistung: 4,5W
Material: Aluminium



Maßzeichnung

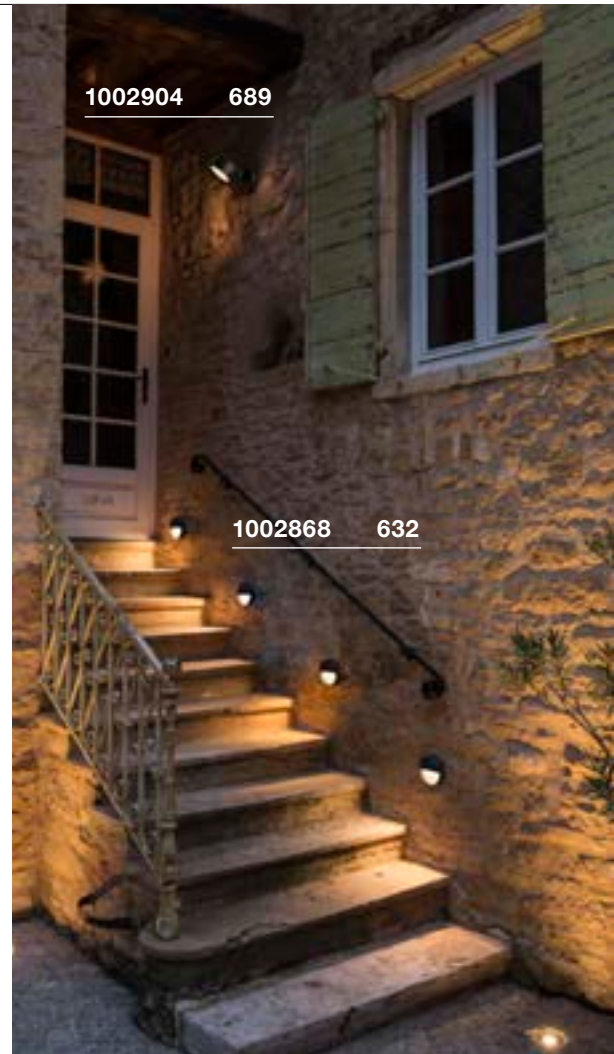
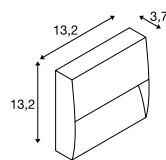

Variante	Art. Nr.
140lm 3000/4000K CRI>80 ■ matt anthrazit	1002868

Variante	Art. Nr.
150lm 3000/4000K CRI>80 ■ matt anthrazit	1002869



231010 633

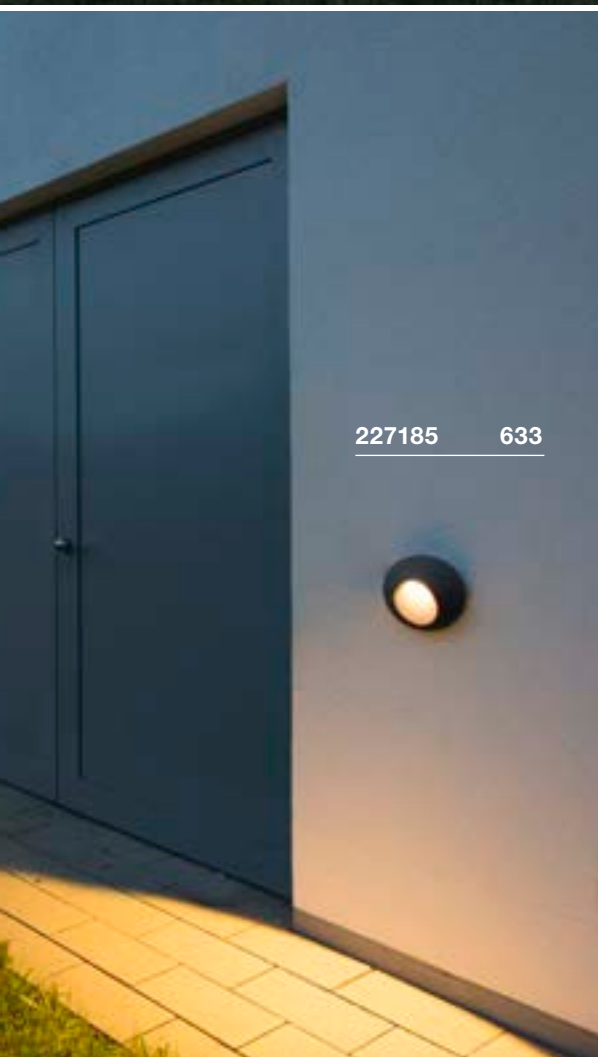

227185 633

PEMA®
WL

A-A++ Spektrum A++-E

LED INSIDE



Produktangaben

230V ~50Hz
Systemleistung: 4,7W
Material: Aluminium

Maßzeichnung

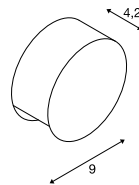

Hinweis

Schutzart IP44 nur bei Montage mit Lichtaustritt nach unten.

Variante	Art. Nr.
125lm 3000K CRI>80 □ weiß	231010
125lm 3000K CRI>80 ■ grau	231012
125lm 3000K CRI>80 ■ anthrazit	231015

DELO
WL

A-A++ Spektrum A++-E

LED INSIDE



Produktangaben

100-240V ~50/60Hz | 500mA
Systemleistung: 5,8W
Material: Aluminium / Glas



Maßzeichnung

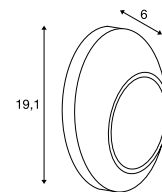

Hinweis

Schutzart IP55 nur bei Montage mit Lichtaustritt nach unten.

Variante	Art. Nr.
170lm 3000K CRI>80 ■ anthrazit	227185

RASCALI
WL

894

A-A++ Spektrum
A++-ELED
INSIDE

- Außergewöhnliches Design
- Ästhetische Akzentuierung von Außenbereichen

Produktangaben

220-240V ~50Hz
Systemleistung: 8W
Material: Aluminium

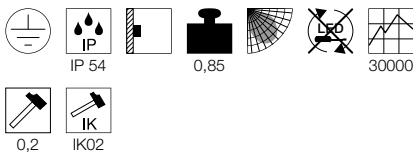

Maßzeichnung

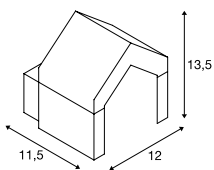

1000797 634



Variante	Art. Nr.
330lm 3000K CRI>80	
■ anthrazit	1000797



227195 635

WALLYX
WL, QPAR51E-A++ Spektrum
A++-E

Produktangaben

220-240V ~50/60Hz
Material: Aluminium / Glas

IP 44



0,67

Maßzeichnung

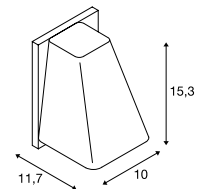

Leuchtmittlempfehlung

LED GU10 7,2W 36°
3000K 520lm EEK=A+
8kWh/1000h

Art. Nr. 1001563

LED GU10 5,5W 38°
2700K 400lm EEK=A+
6kWh/1000h

Art. Nr. 1001030



Leuchtmittelangaben

max. 50W QPAR51
L: 7,6 cm max.

Variante	Art. Nr.
GU10 QPAR51 ■ grau / transparent	227194
GU10 QPAR51 ■ anthrazit	227195
GU10 QPAR51 ■ bronze	227198



reddot award 2018
winner



DESIGNED BY
Carsten Witsch



"Form, function, processing and ease of use should be harmonious in a product. Good design is characterized not only by the appearance of the products, but also by its functionality."

**BENDO
WL, TRIAC**



A-A++ Spektrum
A++-E

LED
INSIDE



- Hochvolt LED

Produktangaben

220-240V ~50/60Hz
Systemleistung: 12W
Material: Aluminium / Glas
Dimmbar: Triac C, Triac L

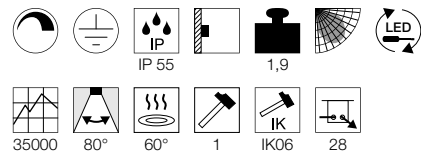

Maßzeichnung

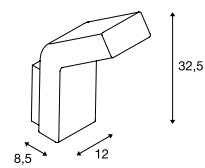

Variante	Art. Nr.
820lm 3000K CRI>80 ■ anthrazit	231865



232405 637

MERVALED SENSOR WL

A-A++ Spektrum A++-E

LED INSIDE



- Integrierter Infrarot-Sensor

Produktangaben

220-240V ~50/60Hz | 300mA
Systemleistung: 14W
Material: Aluminium / Acryl

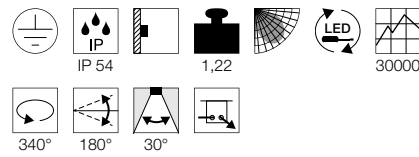

Maßzeichnung

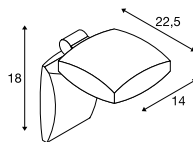

Hinweis

Erfassungswinkel/-distanz: 140°/8 m Tag/
Nachtmodus Die Ansprechempfindlich eit
und Einschaltdauer können eingestellt werden.

Variante	Art. Nr.
1000lm 3000K CRI>80 ■ anthrazit	232405

MERVALED WL

A-A++ Spektrum A++-E

LED INSIDE

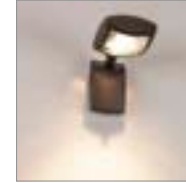

Produktangaben

220-240V ~50/60Hz | 300mA
Systemleistung: 14W
Material: Aluminium / Acryl

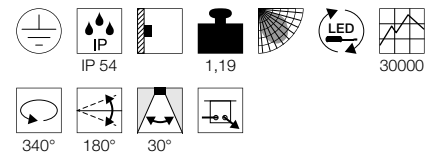

Maßzeichnung

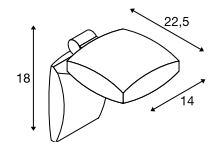

Variante	Art. Nr.
1000lm 3000K CRI>80 ■ anthrazit	232415

ABRIDOR
WL



882

A-A++ Spektrum
A++-E



- Lichtfarbe schaltbar
- Schwenkbarer Leuchtenkopf

Produktangaben

100-277V ~50/60Hz | 300mA
 Systemleistung: 14W
 Material: Aluminium
 Produktmaße: L: 14 cm H: 16 cm T: 17,5 cm

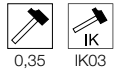
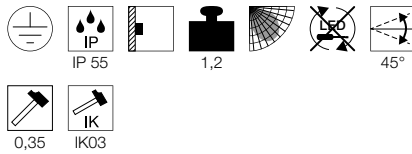

1002989 638



1002952 639

Variante	Art. Nr.
750lm 3000/4000K CRI>80 ■ matt anthrazit	1002989

ABRIDOR SENSOR WL



A-A++ Spektrum A++-E

LED INSIDE

NEW

IR



- Lichtfarbe schaltbar
- Schwenkbarer Leuchtenkopf
- Mit integriertem Infrarot-Bewegungssensor

Produktangaben

100-277V ~50/60Hz | 500mA
 Systemleistung: 14W
 Material: Aluminium
 Produktmaße: L: 14 cm H: 16 cm T: 17,5 cm

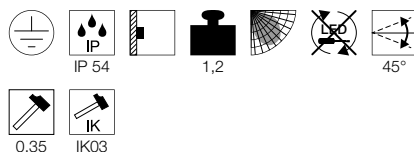

FLATT WL



A-A++ Spektrum A++-E

LED INSIDE

NEW



- Lichtfarbe schaltbar

Produktangaben

100-277V ~50/60Hz | 300mA
 Systemleistung: 14W
 Material: Aluminium / Aluminium
 Produktmaße: B: 18 cm H: 23 cm T: 7 cm

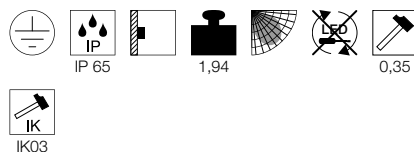

FLATT SENSOR WL



A-A++ Spektrum A++-E

LED INSIDE

NEW

IR



- Lichtfarbe schaltbar
- Mit integriertem Infrarot-Bewegungssensor

Produktangaben

100-277V ~50/60Hz | 500mA
 Systemleistung: 16W
 Material: Aluminium / Aluminium
 Produktmaße: B: 18 cm H: 23 cm T: 7 cm

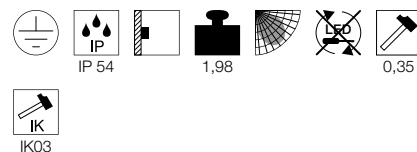

Variante	Art. Nr.
750lm 3000/4000K CRI80 ■ matt anthrazit	1002990

Variante	Art. Nr.
460lm 3000/4000K CRI80 ■ matt anthrazit / matt anthrazit	1002952
500lm 3000/4000K CRI80 ■ matt anthrazit / matt braun	1002953

Variante	Art. Nr.
600lm 3000/4000K CRI80 ■ matt anthrazit / matt anthrazit	1002954
600lm 3000/4000K CRI80 ■ matt anthrazit / matt braun	1002955

ORDI
WL

A-A++ Spektrum A++-E

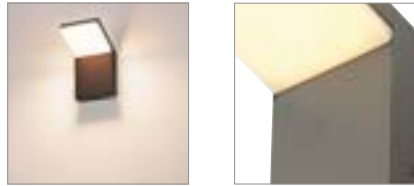

ORDI SENSOR
WL

A-A++ Spektrum A++-E

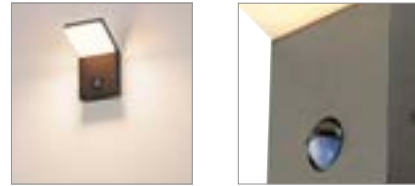

• Mit integriertem Infrarot-Bewegungssensor

Produktangaben

220-240V ~50/60Hz
Systemleistung: 9W
Material: Aluminium

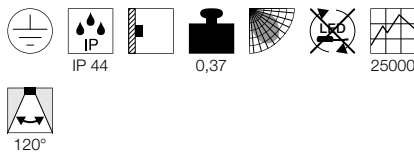

Maßzeichnung

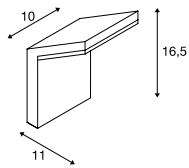

Produktangaben

220-240V ~50/60Hz
Systemleistung: 9W
Material: Aluminium

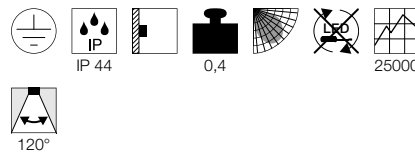

Maßzeichnung

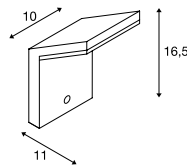

Hinweis

Sensorreichweite einstellbar bis 9 m,
Erfassungswinkel 120°

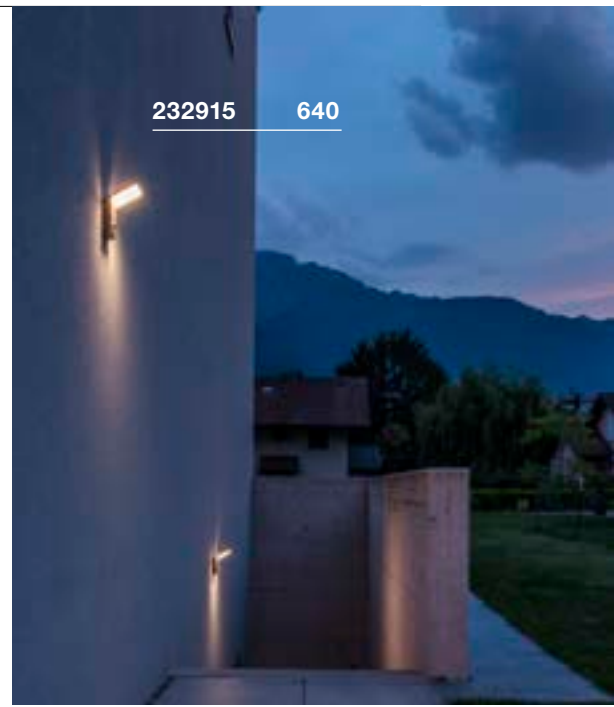

232915 640



231351 641

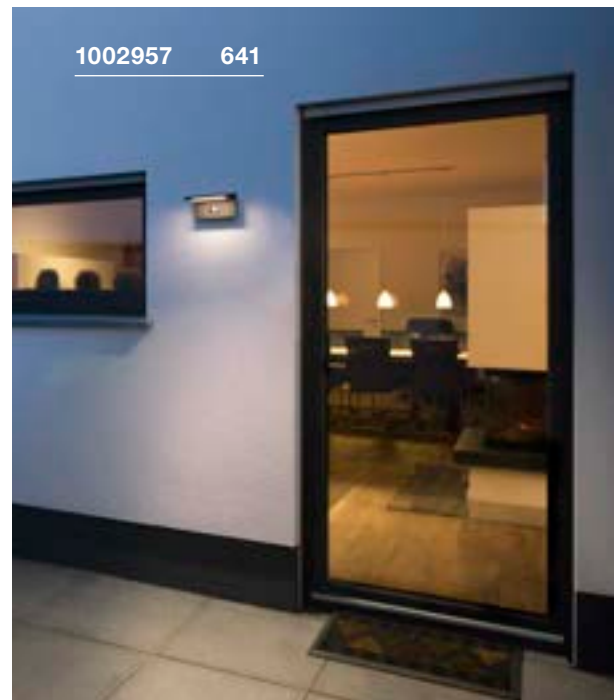

1002957 641

Variante	Art. Nr.
500lm 3000K CRI>80 ■ anthrazit	232905

Variante	Art. Nr.
500lm 3000K CRI>80 ■ anthrazit	232915





ANGOLUX WL

A-A++ Spektrum A++-E





Produktangaben

220-240V ~50/60Hz | 80mA
 Systemleistung: 7,6W
 Material: Aluminium / Kunststoff

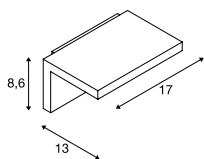

 IP 44
  0,64
  25000
 120°

Maßzeichnung





Hinweis

Schutzart IP44 nur bei Montage mit Lichtaustritt nach unten.

Variante	Art. Nr.
500lm 3000K CRI>80  weiß	231351
500lm 3000K CRI>80  anthrazit	231355





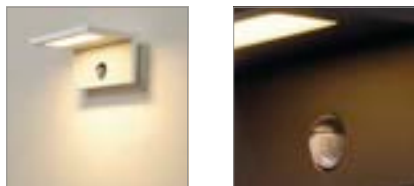

ANGOLUX SENSOR WL

A-A++ Spektrum A++-E





Produktangaben

100-240V ~50/60Hz | 240mA
 Systemleistung: 9,8W
 Material: Aluminium / Kunststoff

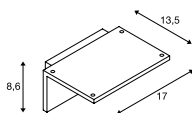

 IP 44
  0,62
  25000
 100°
  0,2
  IK02
  20

Maßzeichnung



Hinweis

Erfassungswinkel 120°, max. Erfassungsdistanz 9 m, Ansprechempfindlichkeit und Einschaltdauer einstellbar
 Schutzart IP44 nur bei Montage mit Lichtaustritt nach unten

Variante	Art. Nr.
560lm 3000K CRI>80  weiß	1001970
560lm 3000K CRI>80  anthrazit	1001969

ANGOLUX SOLAR WL





A-A++ Spektrum A++-E







Produktangaben

Batteriebetrieb
 Systemleistung: 1,8W
 Material: Aluminium

 IP 54
  0,9
  130°
  0,2
 IK02

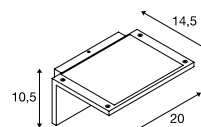
Maßzeichnung



Hinweis

Bewegungsmelder & Solarpanel inkl. Batterie 3,7V 2200mAh

Variante	Art. Nr.
150lm 3000K CRI>80  anthrazit	1002597

IPERI
WL

888

A-A++ Spektrum
A++-ELED
INSIDE

231315 642

Produktangaben

230V ~50Hz
Systemleistung: 5W
Material: Aluminium / Kunststoff

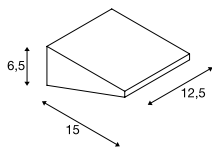
**Maßzeichnung****Hinweis**

Schutzart IP44 nur bei Montage mit Lichtaustritt nach unten.

Variante	Art. Nr.
■ anthrazit	231315



230034 643



1002071 643

PEMA®
WL, E27



Produktangaben

230V ~50Hz
Material: Aluminium / Glas

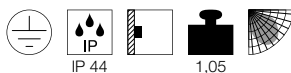

Maßzeichnung

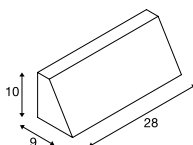

Hinweis

Schutzart IP44 nur bei Montage mit Lichtaustritt nach unten.

Leuchtmittlempfehlung

E27 9W 240°
3000K 810lm EEK=A+
10kWh/1000h
Art. Nr. 1001031

LED E27 15W 240°
3000K 1521lm EEK=A+
15kWh/1000h
Art. Nr. 1001033

Leuchtmittelangaben

max. 15W
Ø: 4,5 cm max. L: 21 cm max.

Variante	Art. Nr.
E27	
■ schwarz	230030
E27	
■ grau / transparent	230034

PEMA®
WL



LED
INSIDE

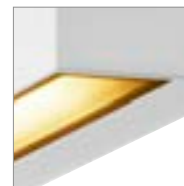
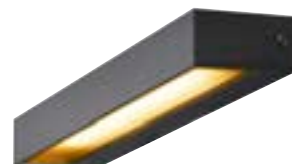

Produktangaben

230V ~50Hz
Systemleistung: 7,7W
Material: Aluminium / Glas

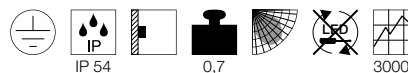

Maßzeichnung

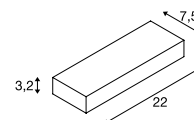

Hinweis

Schutzart IP54 nur bei Montage mit Lichtaustritt nach unten.

Variante	Art. Nr.
450lm 3000K CRI>80	
■ anthrazit	1002069
450lm 3000K CRI>80	
□ weiß	1002070
450lm 3000K CRI>80	
■ grau / transparent	1002071

MALU
WL



A-A++ Spektrum A++-E



reddot award 2019 winner



- Außergewöhnliches Design
- Gleichmäßige Ausleuchtung
- Besonders breite Lichtverteilung

Produktangaben

220-240V ~50/60Hz
Systemleistung: 9,2W
Material: Aluminium / Glas

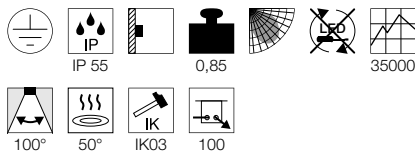

Maßzeichnung

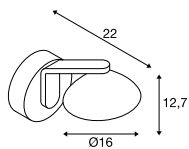

TRAPECCO DOWN
WL



A-A++ Spektrum A++-E



Produktangaben

230V ~50Hz
Systemleistung: 10W
Material: Aluminium

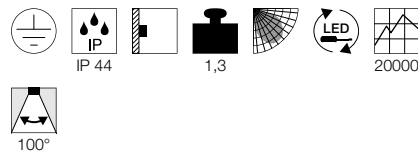

Maßzeichnung

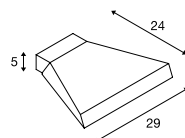

1002155 644



reddot award 2019 winner

DESIGNED BY

Philippe Stephant

Philippe Stephant

102155 644



Variante	Art. Nr.
360lm 3000K CRI>80 ■ anthrazit	1002155

Variante	Art. Nr.
850lm 3000K CRI>80 ■ anthrazit	231745



232285 645

**QUADRASYL
WL, TCR-TSE**



B-A++ Spektrum A++-E

**QUADRASYL
CW, TCR-TSE**



B-A++ Spektrum A++-E



• Blende: Edelstahl 304

Produktangaben

230V ~50Hz
Material: Aluminium / Glas

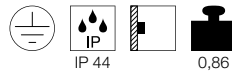

Produktangaben

230V ~50Hz
Material: Aluminium / Edelstahl 304

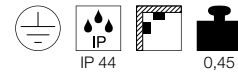

Maßzeichnung

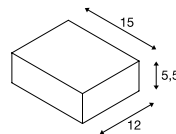

Maßzeichnung

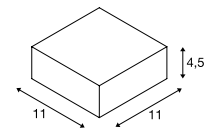

Hinweis

Befestigung auf der Rücksteite



231745 644

Leuchtmittlempfehlung

GX53 3W 120°
3000K 250lm EEK=A++
3kWh/1000h
Art. Nr. 551372



Leuchtmittelangaben

max. 11W TCR-TSE
Ø: 7,5 cm max. L: 2,7 cm max.

Variante	Art. Nr.
GX53 TCR-TSE ■ anthrazit	232285

Leuchtmittlempfehlung

GX53 3W 120°
3000K 250lm EEK=A++
3kWh/1000h
Art. Nr. 551372



Leuchtmittelangaben

max. 9W TCR-TSE
Ø: 7,5 cm max. L: 2,7 cm max.

Variante	Art. Nr.
GX53 TCR-TSE ■ grau	111482

QUAD
WL



A-A++ Spektrum
A++-E

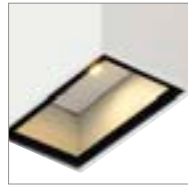

BIG QUAD
WL



A-A++ Spektrum
A++-E

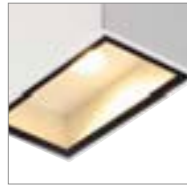

Produktangaben

200-240V ~50/60Hz | 700mA
Systemleistung: 4,6W
Material: Aluminium / Glas



Maßzeichnung

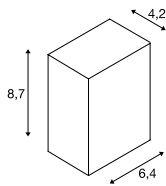

Produktangaben

100-277V ~50/60Hz | 350mA
Systemleistung: 4,5W
Material: Aluminium / Glas



Maßzeichnung

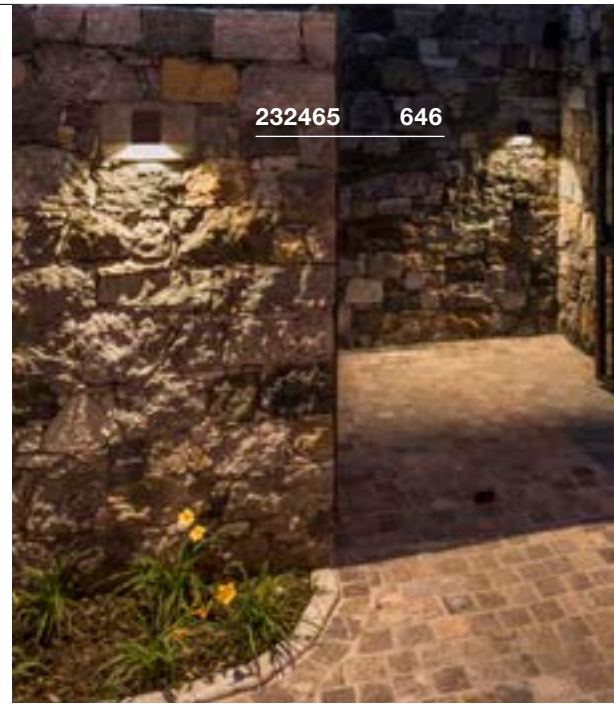
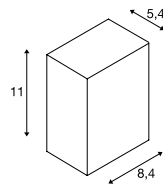

232465 646

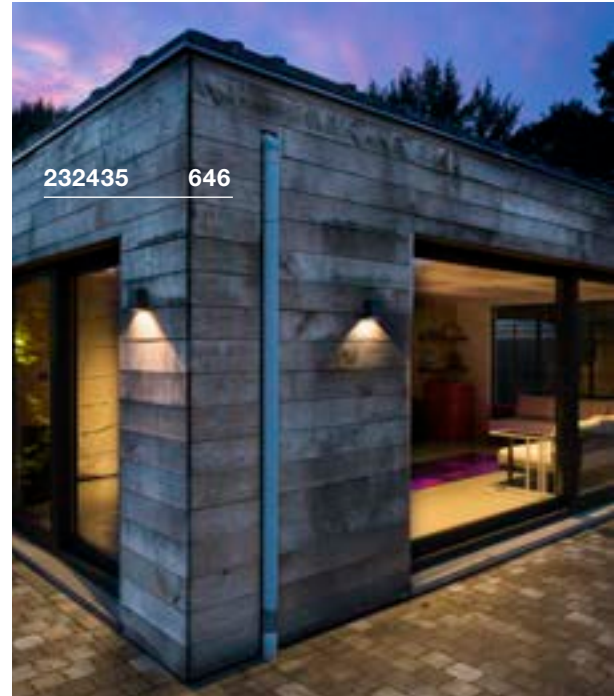

232435 646

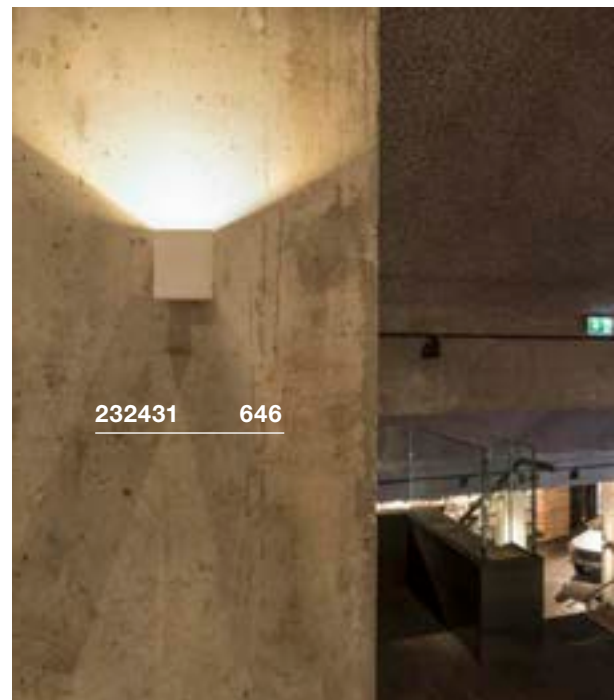

232431 646

Variante	Art. Nr.
100lm 3000K CRI>80	
□ weiß	232461
80lm 3000K CRI>80	
■ anthrazit	232465

Variante	Art. Nr.
290lm 3000K CRI>80	
□ weiß	232431
260lm 3000K CRI>80	
■ anthrazit	232435



1002605 647

SAIL
WL
 889

A-A++

Spektrum
A++-ELED
INSIDE

NEW

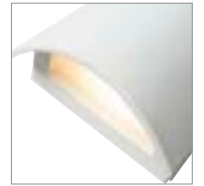
**Produktangaben**

200-240V ~50Hz
Systemleistung: 18W
Material: Aluminium



IP 54

1,9

70°



1

IK06

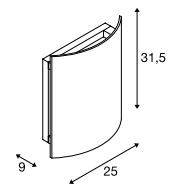
Maßzeichnung

Variante	Art. Nr.
400lm 3000K CRI>80	
■ anthrazit	1002605
590lm 3000K CRI>80	
□ weiß	1002606

VILUA S
WL

A-A++ Spektrum A++-E

LED
INSIDE

NEW

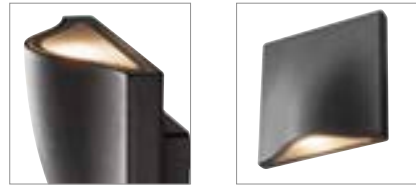

Produktangaben

100-277V ~50/60Hz | 700mA
Systemleistung: 8,3W
Material: Aluminium / Glas

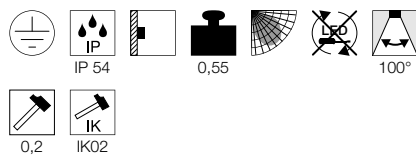

Maßzeichnung

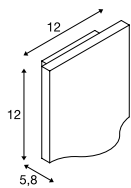

1002503 648



1002504 649

Variante	Art. Nr.
405lm 3000K CRI>80 ■ anthrazit	1002503

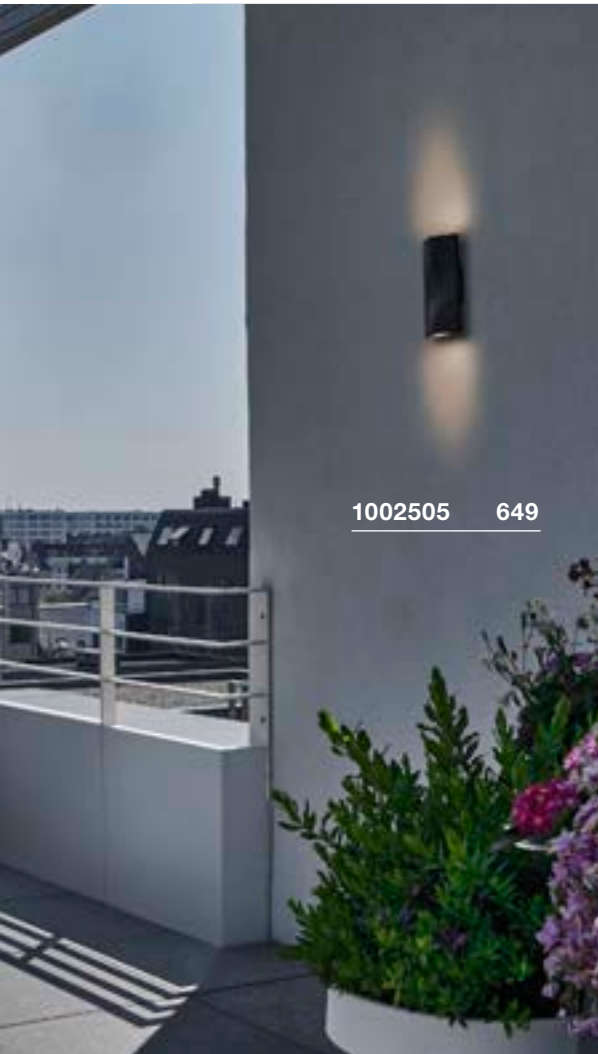

1002505 649



1002504 649

VILUA L
WL

A-A++ Spektrum
A++-E

LED
INSIDE

NEW

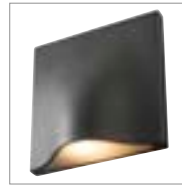
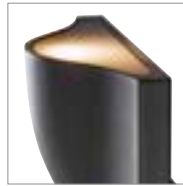

VILUA
UP/DOWN, WL

A-A++ Spektrum
A++-E

LED
INSIDE

NEW

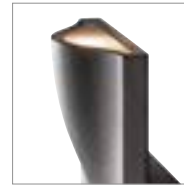

Produktangaben

100-277V ~50/60Hz | 350mA
Systemleistung: 16W
Material: Aluminium / Glas

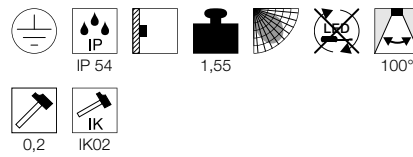

Maßzeichnung

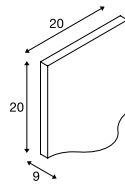

Produktangaben

100-277V ~50/60Hz | 700mA
Systemleistung: 16W
Material: Aluminium / Glas

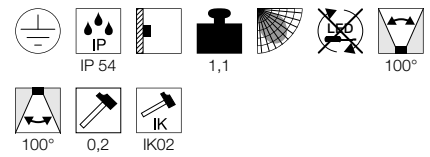

Maßzeichnung

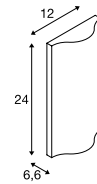

Variante	Art. Nr.
810lm 3000K CRI>80 ■ anthrazit	1002504

Variante	Art. Nr.
Up: 392lm 3000K CRI>80 Down: 392lm 3000K CRI>80 ■ anthrazit	1002505

THEO
WL, QPAR51



E-A++ Spektrum A++-E



BIG THEO
WL, QPAR111



E-A++ Spektrum A++-E



Produktangaben

230V ~50Hz
Material: Aluminium / Glas

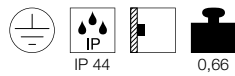

Maßzeichnung

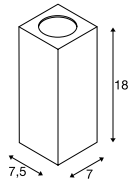

Produktangaben

230V ~50Hz
Material: Aluminium / Glas

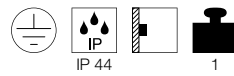

Maßzeichnung

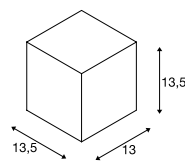

Leuchtmittlempfehlung

LED GU10 7,2W 36°
4000K 540lm EEK=A+
8kWh/1000h
Art. Nr. 1001566



LED GU10 5,5W 38°
2700K 400lm EEK=A+
6kWh/1000h
Art. Nr. 1001030



Leuchtmittlempfehlung

GU10 7W 13°
3000K 660lm EEK=A+
8kWh/1000h
Art. Nr. 1001568



LED GU10 13W 140°
2700K 1000lm EEK=A+
13kWh/1000h
Art. Nr. 1001244



Leuchtmittelangaben

max. 35W QPAR51

Leuchtmittelangaben

max. 75W QPAR111

Variante	Art. Nr.
GU10 QPAR51	
□ weiß	229521
GU10 QPAR51	
▨ grau / transparent	229524
GU10 QPAR51	
■ anthrazit	229525

Variante	Art. Nr.
GU10 QPAR111	
□ weiß	229561
GU10 QPAR111	
▨ grau / transparent	229564
GU10 QPAR111	
■ anthrazit	229565

229525 650



229561 650





234525 651



234521 651

BIG THEO
WL
 885
A-A++ Spektrum
A++-ELED
INSIDE

Produktangaben

100-277V ~50/60Hz | 500mA
Systemleistung: 21W
Material: Aluminium / Glas

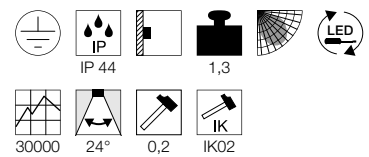

Maßzeichnung

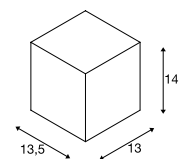

Variante	Art. Nr.
2000lm 3000K CRI>80 □ weiß	234521
2000lm 3000K CRI>80 ■ grau / transparent	234524
2000lm 3000K CRI>80 ■ anthrazit	234525

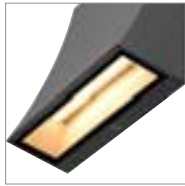
DELWA
WLA-A++ Spektrum
A++-ELED
INSIDE

Produktangaben

100-240V ~50/60Hz | 700mA
Systemleistung: 10W
Material: Aluminium / Glas

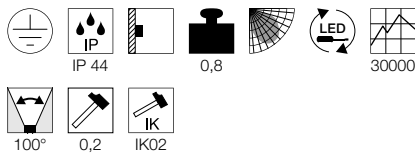

Maßzeichnung

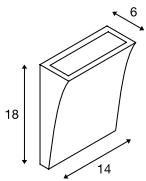

230791 652

Variante	Art. Nr.
910lm 3000K CRI>80 □ weiß	1000340
910lm 3000K CRI>80 ■ grau	1000341
910lm 3000K CRI>80 ■ anthrazit	1000342

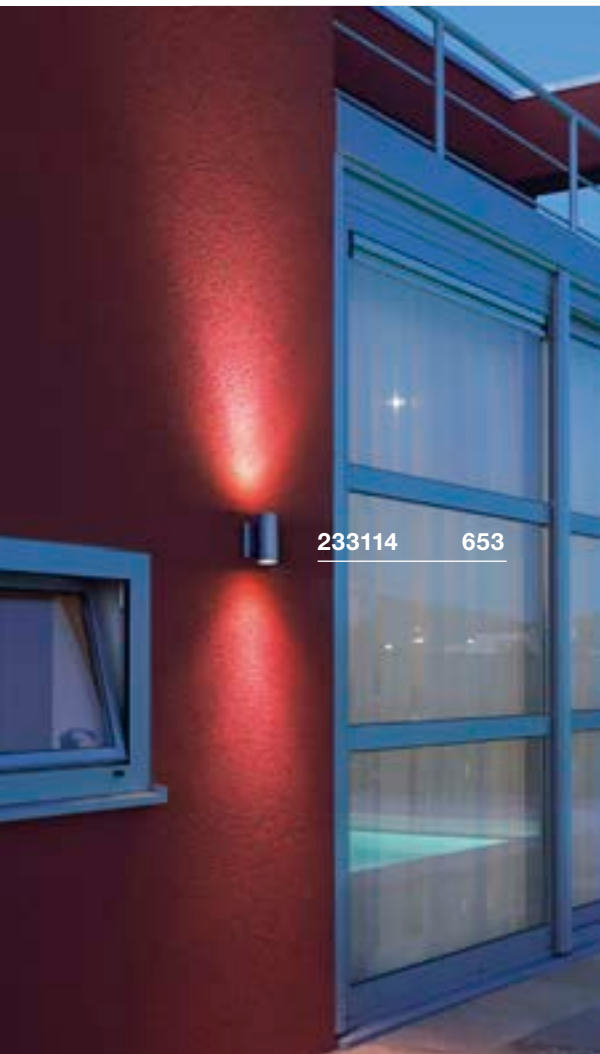

233114 653

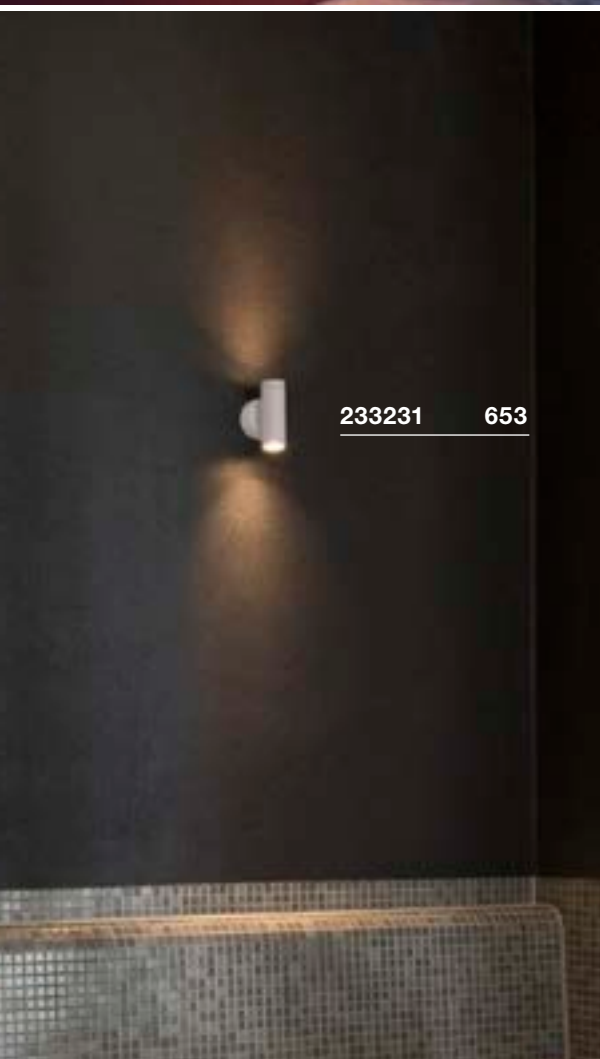

233231 653

MYRA UP/DOWN
WL, QPAR51



E-A++ Spektrum A++-E



Produktangaben

220-240V ~50/60Hz
Material: Aluminium / Glas

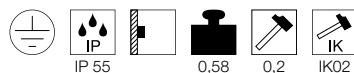

Maßzeichnung

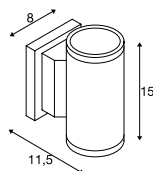

Zubehörempfehlung

- Aufbaumontage Rahmen
Art. Nr. 233214
- Aufbaumontage Rahmen
Art. Nr. 233215

Leuchtmittlempfehlung

LED GU10 4,3W 40°
2700K 365lm EEK=A++
5kWh/1000h
Art. Nr. 560142



LED GU10 4,3W 40°
3000K 375lm EEK=A++
5kWh/1000h
Art. Nr. 560143



Leuchtmittelangaben

2x max. 35W QPAR51
Ø: 5 cm max. L: 5,7 cm max.

Variante	Art. Nr.
GU10 QPAR51	
■ grau	233114
GU10 QPAR51	
■ anthrazit	233115

HELIA UP/DOWN
WL, TRIAC



A-A++ Spektrum A++-E

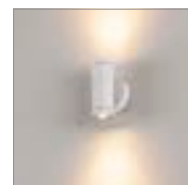

• Hochvolt LED

Produktangaben

220-240V ~50/60Hz
Systemleistung: 12W
Material: Aluminium / Glas
Dimmbar: Triac C, Triac L

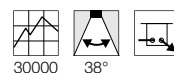
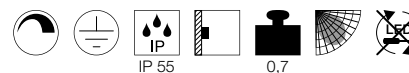

Maßzeichnung

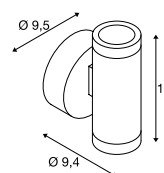

Variante	Art. Nr.
Up: 350lm 3000K CRI>80 Down: 350lm 3000K CRI>80	
□ weiß	233231
Up: 350lm 3000K CRI>80 Down: 350lm 3000K CRI>80	
■ anthrazit	233235

SITRA UP/DOWN
WL, TCR-TSE



B-A++ Spektrum
A++-E



SITRA UP/DOWN
WL



A-A++ Spektrum
A++-E



ASTINA
WL, QPAR51



B-A++ Spektrum
A++-E



Produktangaben

230V ~50Hz
Material: Aluminium / Glas

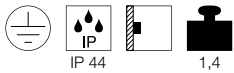

Maßzeichnung

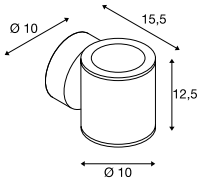

Leuchtmittlempfehlung

GX53 3W 120°
3000K 250lm EEK=A++
3kWh/1000h
Art. Nr. 551372



Leuchtmittelangaben

2x max. 9W TCR-TSE
Ø: 7,5 cm max. L: 3,5 cm max.

Variante	Art. Nr.
GX53 TCR-TSE	
■ anthrazit	230365

Produktangaben

220-240V ~50/60Hz
Systemleistung: 17W
Material: Aluminium / Glas



Maßzeichnung

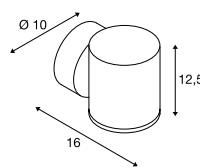

Leuchtmittlempfehlung

Up: 488lm | 3000K | CRI>80
Down: 488lm | 3000K | CRI>80
■ anthrazit 1002018
Up: 488lm | 3000K | CRI>80
Down: 488lm | 3000K | CRI>80
□ weiß 1002041

Variante	Art. Nr.
Up: 488lm 3000K CRI>80 Down: 488lm 3000K CRI>80	
■ anthrazit	1002018
Up: 488lm 3000K CRI>80 Down: 488lm 3000K CRI>80	
□ weiß	1002041

Produktangaben

230V ~50Hz
Material: Aluminium / Glas

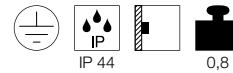

Maßzeichnung

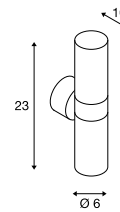

Leuchtmittlempfehlung

GU10 4,3W 40°
2700K 245lm EEK=A+
5kWh/1000h
Art. Nr. 551252



LED GU10 5,1W 48°
2700-6500K 350lm EEK=A+
6kWh/1000h
Art. Nr. 1001918



Leuchtmittelangaben

2x max. 11W TCR50-SE
L: 9 cm max.

Variante	Art. Nr.
GU10 TCR50-SE	
□ weiß	228771
GU10 TCR50-SE	
■ anthrazit	228775
GU10 TCR50-SE	
□ matt aluminium	228776



228775 654



233302 655

ASTINA STEEL
WL, QPAR51



E-A++ Spektrum A++-E



- Leuchte aus Edelstahl 304
- Enge Abstrahlcharakteristik zur konturierten Akzentuierung von vertikalen Flächen

Produktangaben

230V ~50Hz
Material: Edelstahl 304

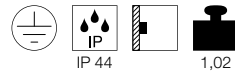

Maßzeichnung

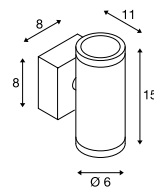

Leuchtmittlempfehlung

LED GU10 3,7W 36°
2700K 260lm EEK=A+
4kWh/1000h
Art. Nr. 560122



LED GU10 4,3W 40°
2700K 365lm EEK=A++
5kWh/1000h
Art. Nr. 560142



Leuchtmittelangaben

2x max. 35W QPAR51
Ø: 5,1 cm max. L: 5,7 cm max.

Variante	Art. Nr.
GU10 QPAR51	
edelstahl	233302

ASTINA STEEL
WL



A-A++ Spektrum A++-E

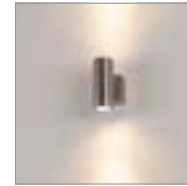

- Leuchte aus hochwertigem Edelstahl 316
- Enge Abstrahlcharakteristik zur konturierten Akzentuierung von vertikalen Flächen

Produktangaben

100-277V ~50/60Hz | 350mA
Systemleistung: 8,7W
Material: Edelstahl 316



Maßzeichnung

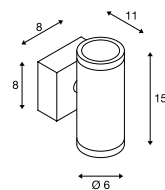

Variante	Art. Nr.
510lm 3000K CRI>80	
edelstahl	233312

ROX UP/DOWN
WL, QPAR111



E-A++ Spektrum
A++-E

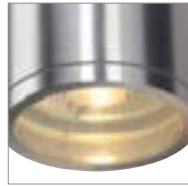

• Hochwertig gebürstete Oberfläche

Produktangaben

230V ~50Hz
Material: Aluminium / Glas

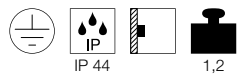

Maßzeichnung

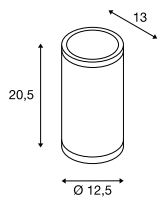

Leuchtmittlempfehlung

LED GU10 10W 38°
3000K 630lm EEK=A+
10kWh/1000h
Art. Nr. 1001029



LED GU10 13W 30°
4000K 1300lm EEK=A+
13kWh/1000h
Art. Nr. 1001243



Leuchtmittelangaben

2x max. 50W QPAR111

Variante	Art. Nr.
GU10 QPAR111 gebürstet aluminium	1000334

ENOLA C UP/DOWN
WL



A-A++ Spektrum
A++-E



Produktangaben

220-240V ~50/60Hz | 500mA
Systemleistung: 23W
Material: Aluminium / Glas



Maßzeichnung

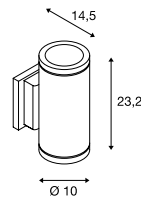

Zubehörempfehlung

Aufbaumontage Rahmen
Art. Nr. 233211
 Aufbaumontage Rahmen
Art. Nr. 233215



Variante	Art. Nr.
1800lm 3000K CRI>80 weiß	228521
1800lm 3000K CRI>80 anthrazit	228525

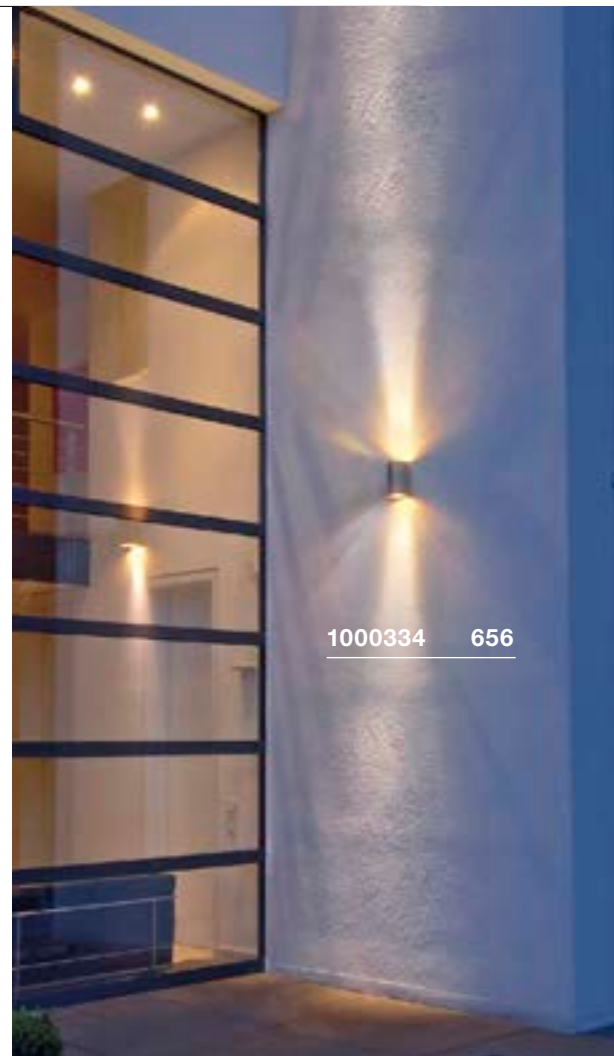

1000334 656



1000334 656



1000446 657

229072 682

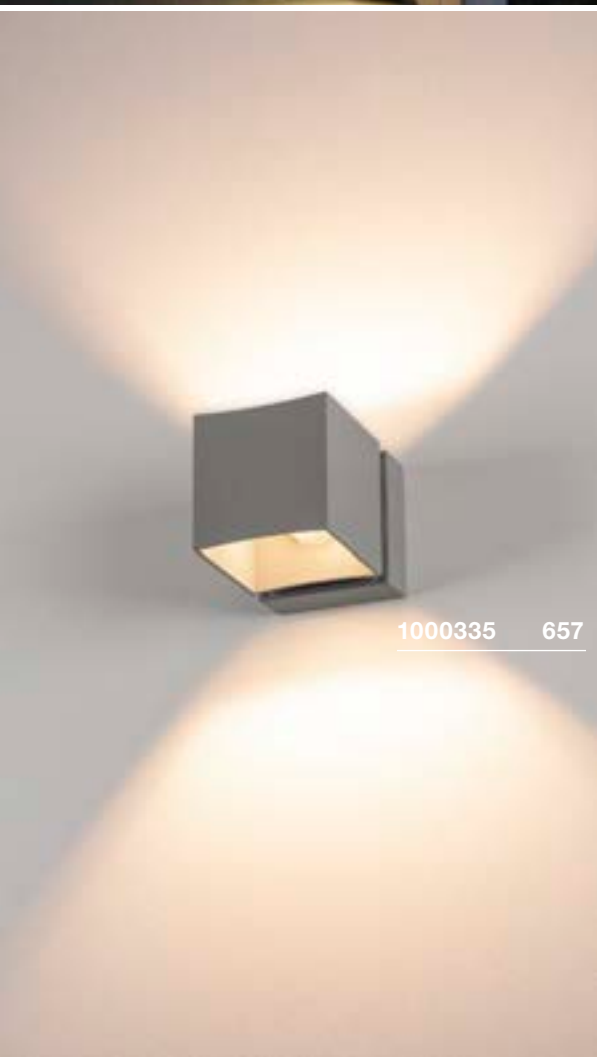

1000335 657

POLE PARC UP/DOWN WL  894

A-A++ Spektrum A++-E

LED INSIDE



- Direkt-indirekte rotationssymmetrische Lichtverteilung
- Ideal geeignet zur effektiven Akzentuierung der Gebäudearchitektur

Produktangaben

100-240V ~50/60Hz | 700mA
Systemleistung: 56W
Material: Aluminium / Glas

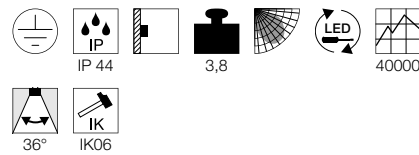

Maßzeichnung

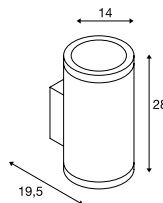

SQUARE TURN WL, G9  896

D-A+ Spektrum A++-E

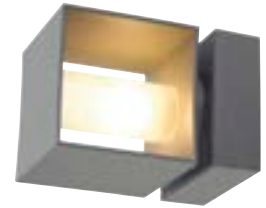

- 360° drehbares Frontteil

Produktangaben

230V ~50Hz
Material: Aluminium / Glas



Maßzeichnung

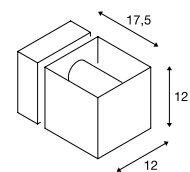

Leuchtmittelempfehlung

G9 2,5W
2700K 180lm EEK=A+
3kWh/1000h
Art. Nr. 560302

LED G9 3,5W
2800K 300lm EEK=A+
4kWh/1000h
Art. Nr. 1002131



Leuchtmittelangaben

max. 42W QT14
Ø: 3,5 cm max. L: 8 cm max.

Variante	Art. Nr.
Up: 2900lm 3000K CRI>80 Down: 2900lm 3000K CRI>80 ■ anthrazit	1000446

Variante	Art. Nr.
G9 QT14 ■ grau	1000335

QUAD UP/DOWN 12
WL



A-A++ Spektrum
A++-E



LED
INSIDE



QUAD UP/DOWN 15
WL



A-A++ Spektrum
A++-E



LED
INSIDE

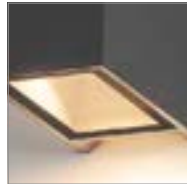
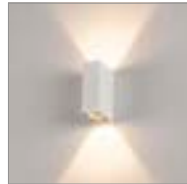

Produktangaben

200-240V ~50/60Hz | 700mA
Systemleistung: 6,8W
Material: Aluminium / Glas

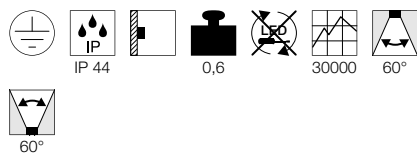

Maßzeichnung

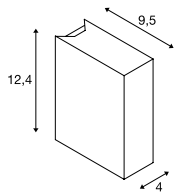

Hinweis

Montagefläche an schmaler Gehäusesesei e

Produktangaben

100-277V ~50/60Hz | 350mA
Systemleistung: 8,6W
Material: Aluminium / Glas

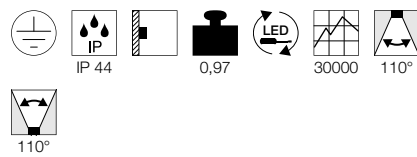

Maßzeichnung

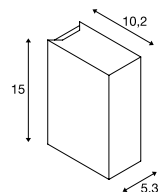

Hinweis

Montagefläche an schmaler Gehäusesesei e

232445 658



232441 658

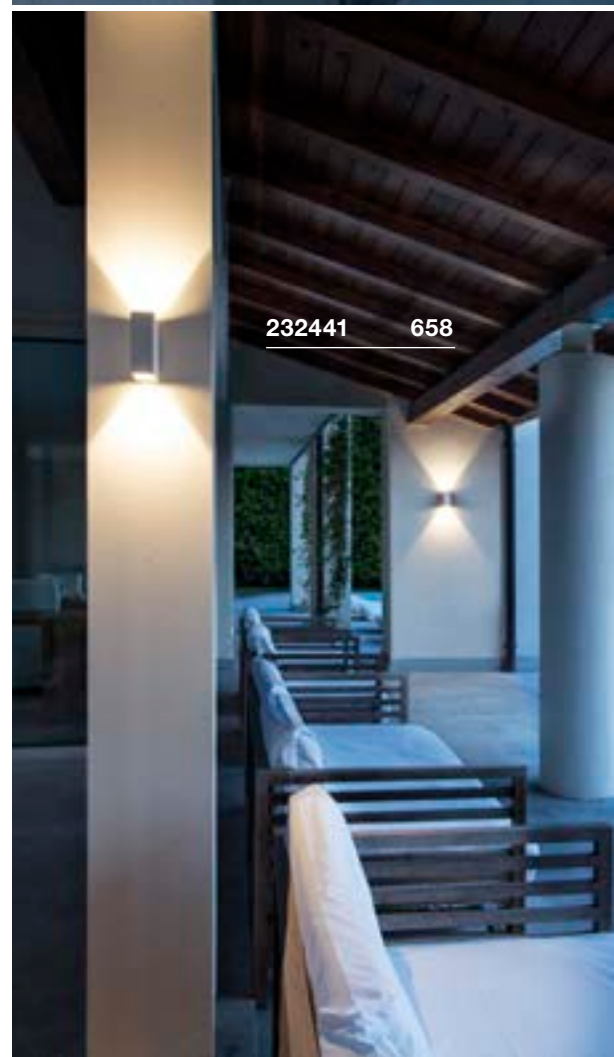

Variante	Art. Nr.
175lm 3000K CRI>80	
□ weiß	232471
140lm 3000K CRI>80	
■ anthrazit	232475

Variante	Art. Nr.
290lm 3000K CRI>80	
□ weiß	232441
260lm 3000K CRI>80	
■ anthrazit	232445

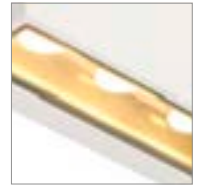
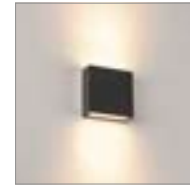

232471 658

BIG QUAD UP/DOWN
WLA-A++ Spektrum
A++-ELED
INSIDE

Produktangaben

200-240V ~50/60Hz | 350mA
Systemleistung: 8,8W
Material: Aluminium / Glas



30°

Maßzeichnung

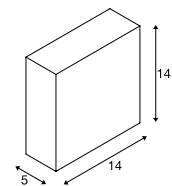

Variante	Art. Nr.
240lm 3000K CRI>80 □ weiß	232451
240lm 3000K CRI>80 ■ anthrazit	232455

MANA OUT WL



891

A-A++ Spektrum
A++-E



LED
INSIDE

NEW



- Engere Abstrahlung mit beiliegendem Zubehör möglich

Produktangaben

220-240V ~50/60Hz

Systemleistung: 12W

Material: Aluminium / Stahl

Dimmbar: Triac C, Triac L

Produktmaße: L: 16 cm B: 16 cm H: 9,3 cm



IP 65



1,47



30000



60°

1002900 660

Variante	Art. Nr.
650lm 3000K CRI>80 ■ anthrazit	1002900
650lm 3000K CRI>80 ■ rost / anthrazit	1002902



232495 661



232495 661

**BOX-L
WL, E27**

A-A++ Spektrum A++-E

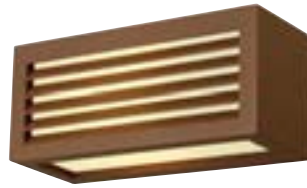

Produktangaben

220-240V ~50/60Hz
Material: Aluminium / Acryl

Maßzeichnung

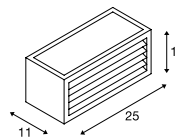

Leuchtmittlempfehlung

LED E27 9,1W 240°
2700K 760lm EEK=A+
10kWh/1000h
Art. Nr. 560402



LED E27 9W 240°
3000K 810lm EEK=A+
10kWh/1000h
Art. Nr. 1001031



Leuchtmittelangaben

max. 18W
Ø: 6 cm max. L: 17,5 cm max.

Variante	Art. Nr.
E27 weiß	232491
E27 anthrazit	232495
E27 rost	232497

**BOX-L
WL**

A-A++ Spektrum A++-E



Produktangaben

220-240V ~50/60Hz
Systemleistung: 19W
Material: Aluminium / Acryl

Maßzeichnung

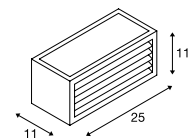

Variante	Art. Nr.
480lm 3000K CRI>80 weiß	1002037
480lm 3000K CRI>80 anthrazit	1002035
480lm 3000K CRI>80 rost	1002036

BOX UP/DOWN
WL, QT-DE12

232485 662

Produktangaben

220-240V ~50/60Hz
Material: Aluminium / Glas

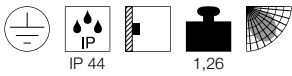

Maßzeichnung

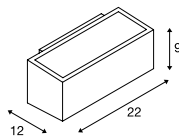

Leuchtmittlempfehlung

R7s 78mm 5,5W 330°
3000K 530lm EEK=A+
6kWh/1000h
Art. Nr. 560332



Leuchtmittelangaben

max. 80W QT-DE12

Variante	Art. Nr.
R7s 78mm QT-DE12	
□ weiß	232481
R7s 78mm QT-DE12	
■ anthrazit	232485



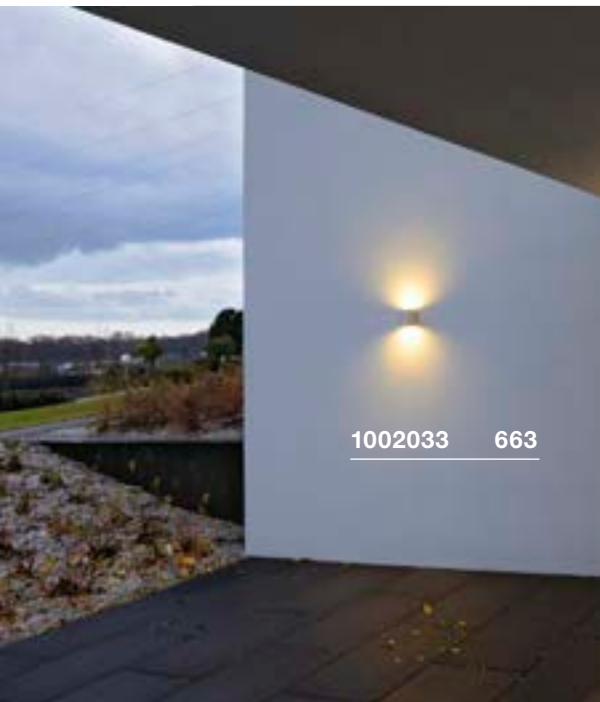

1002033 663

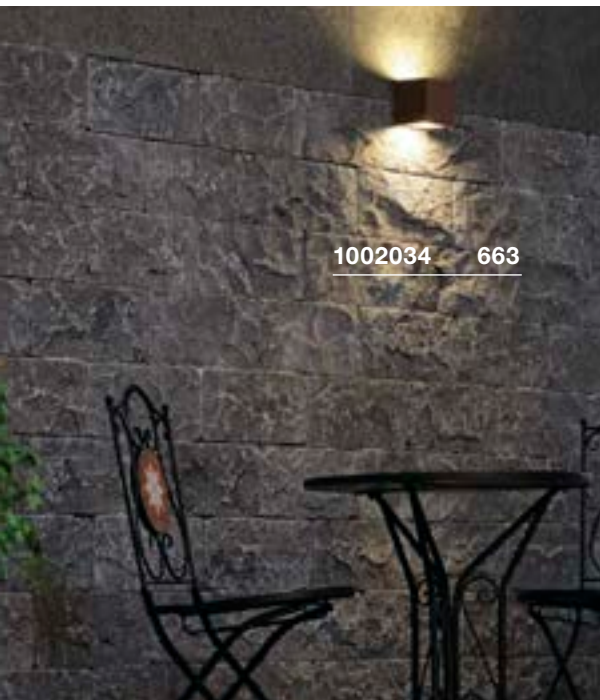

1002034 663



1002034 663

SITRA CUBE
WL, TCR-TSE



B-A++ Spektrum A++-E



Produktangaben

220-240V ~50/60Hz
Material: Aluminium / Glas

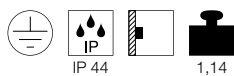

Maßzeichnung

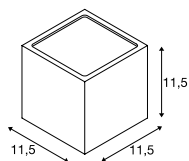

Leuchtmittlempfehlung

GX53 3W 120°
3000K 250lm EEK=A++
3kWh/1000h
Art. Nr. 551372



Leuchtmittelangaben

2x max. 9W TCR-TSE
Ø: 7,5 cm max. L: 2,7 cm max.

Variante	Art. Nr.
GX53 TCR-TSE □ weiß	232531
GX53 TCR-TSE ■ anthrazit	232535
GX53 TCR-TSE ■ rost	232537

SITRA CUBE
WL



A-A++ Spektrum A++-E



LED
INSIDE



Produktangaben

100-277V ~50/60Hz | 500mA
Systemleistung: 10W
Material: Aluminium / Glas

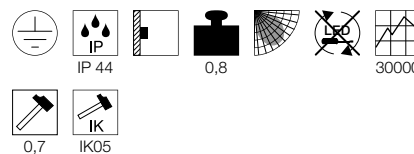

Maßzeichnung

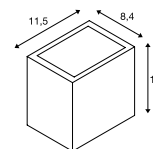

Variante	Art. Nr.
Up: 560lm 3000K CRI>80 Down: 560lm 3000K CRI>80 ■ anthrazit	1002032
Up: 560lm 3000K CRI>80 Down: 560lm 3000K CRI>80 □ weiß	1002033
Up: 560lm 3000K CRI>80 Down: 560lm 3000K CRI>80 ■ rost	1002034

LOGS
WL

890

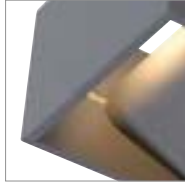
A-A++ Spektrum
A++-ELED
INSIDE**Produktangaben**

100-240V ~50/60Hz | 500mA
Systemleistung: 8W
Material: Aluminium

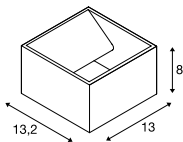
**Maßzeichnung**

232101

664

Variante	Art. Nr.
650lm 3000K CRI>80 □ weiß	232101
550lm 3000K CRI>80 ■ grau	232104
420lm 3000K CRI>80 ■ anthrazit	232105



229535 665



229532 665

THEO UP/DOWN
WL, QPAR51



E-A++ Spektrum A++-E



Produktangaben

220-240V ~50/60Hz
Material: Aluminium / Glas



Maßzeichnung

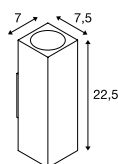

Leuchtmittlempfehlung

LED GU10 7W 25/40/55°
3000K 300lm EEK=A
7kWh/1000h
Art. Nr. 560603



LED GU10 4,3W 40°
2700K 365lm EEK=A++
5kWh/1000h
Art. Nr. 560142



Leuchtmittelangaben

2x max. 35W QPAR51

Variante	Art. Nr.
GU10 QPAR51	
<input type="checkbox"/> weiß	229531
GU10 QPAR51	
<input checked="" type="checkbox"/> grau / transparent	229532
GU10 QPAR51	
<input checked="" type="checkbox"/> anthrazit	229535
GU10 QPAR51	
<input type="checkbox"/> matt aluminium	1000331

BIG THEO UP/DOWN
WL, QPAR111



E-A++ Spektrum A++-E

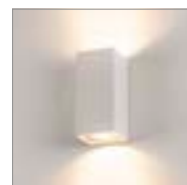

Produktangaben

230V ~50Hz
Material: Aluminium / Glas

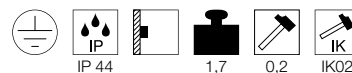

Maßzeichnung

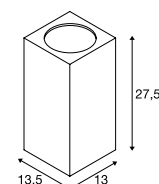

Leuchtmittlempfehlung

LED GU10 10W 38°
3000K 630lm EEK=A+
10kWh/1000h
Art. Nr. 1001029



LED GU10 7,3W 13°
4000K 660lm EEK=A+
8kWh/1000h
Art. Nr. 1000942



Leuchtmittelangaben

2x max. 75W QPAR111

Variante	Art. Nr.
GU10 QPAR111	
<input type="checkbox"/> weiß	229571
GU10 QPAR111	
<input checked="" type="checkbox"/> grau / transparent	229574
GU10 QPAR111	
<input checked="" type="checkbox"/> anthrazit	229575

**BIG THEO FLOOD
UP/DOWN
WL**



A-A++ Spektrum A++-E



**BIG THEO BEAM
UP/FLOOD DOWN
WL**



A-A++ Spektrum A++-E



Produktangaben

100-240V ~50/60Hz | 1000mA
Systemleistung: 42W
Material: Aluminium / Glas

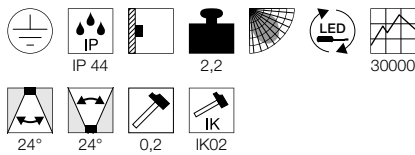

Maßzeichnung

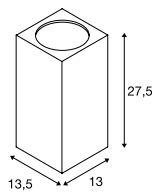

Produktangaben

120-240V ~50/60Hz | 500mA
Systemleistung: 29W
Material: Aluminium / Glas

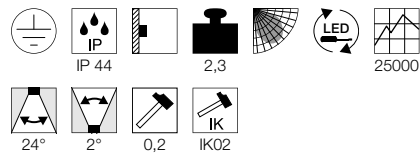

Maßzeichnung

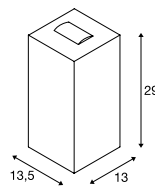

Variante	Art. Nr.
Up: 2000lm 3000K CRI>80 Down: 2000lm 3000K CRI>80 □ weiß	234501
Up: 2000lm 3000K CRI>80 Down: 2000lm 3000K CRI>80 ■ grau / transparent	234504
Up: 2000lm 3000K CRI>80 Down: 2000lm 3000K CRI>80 ■ anthrazit	234505

Variante	Art. Nr.
Flood: 2000lm 3000K CRI>80 Beam: 130lm 3000K CRI>80 □ weiß	234511
Flood: 2000lm 3000K CRI>80 Beam: 130lm 3000K CRI>80 ■ grau / transparent	234514
Flood: 2000lm 3000K CRI>80 Beam: 130lm 3000K CRI>80 ■ anthrazit	234515





234504 666

OUT-BEAM UP/DOWN
WL, QT-DE12

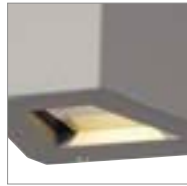

OUT-BEAM UP/DOWN
WL

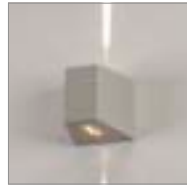

Produktangaben

230V ~50/60Hz
Material: Aluminium / Glas

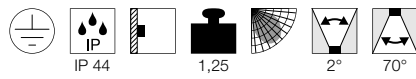

Maßzeichnung

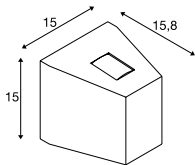

Produktangaben

120-277V ~50/60Hz | 500mA
Systemleistung: 15W
Material: Aluminium / Glas

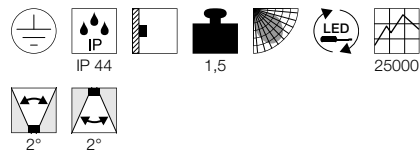

Maßzeichnung

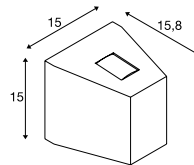

Leuchtmittelangaben

80W QT-DE12
L: 7,8 cm max.

Variante	Art. Nr.
R7s 78mm QT-DE12	
■ grau	1000587
R7s 78mm QT-DE12	
■ anthrazit	1000588

Variante	Art. Nr.
Up: 50lm 3000K CRI>80	
Down: 50lm 3000K CRI>80	
■ grau / transparent	229694
Up: 50lm 3000K CRI>80	
Down: 50lm 3000K CRI>80	
■ anthrazit	229695

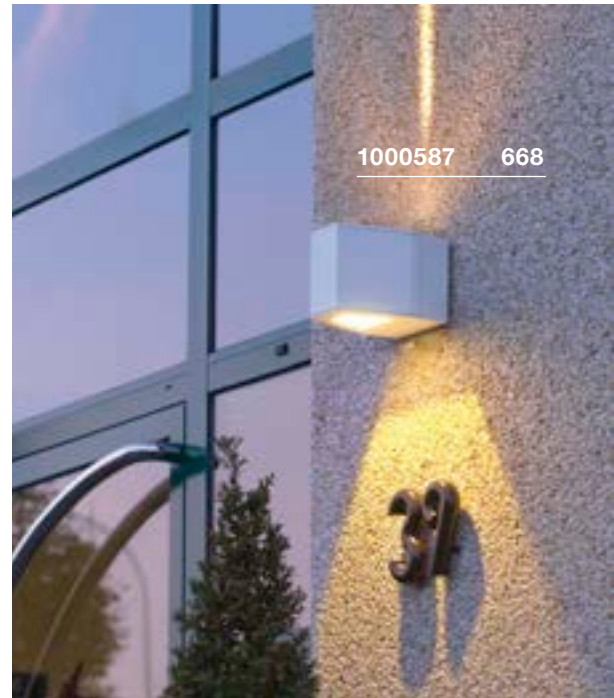

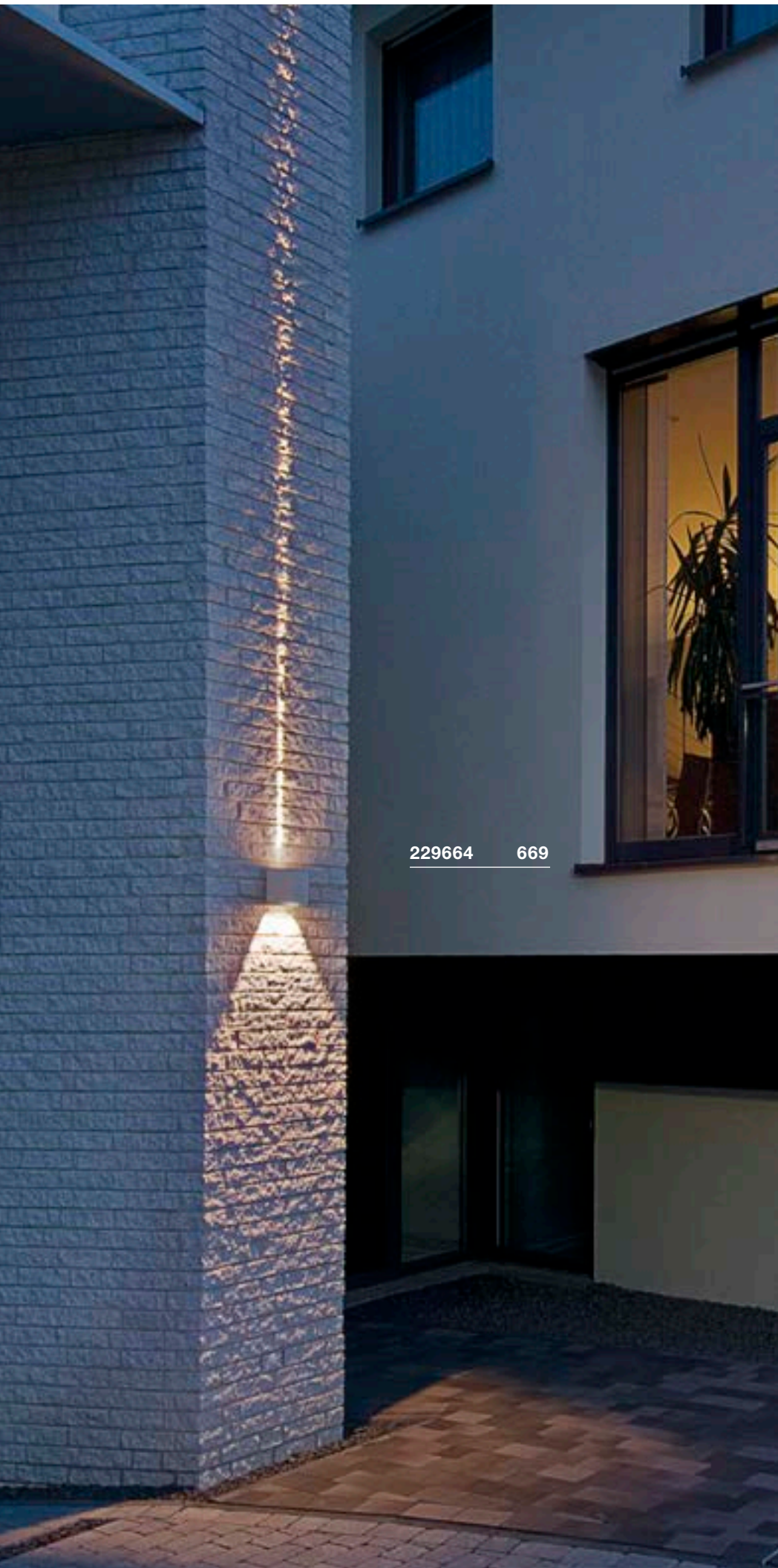

229664 669

OUT-BEAM UP/
FLOOD DOWN
WL

A-A++ Spektrum
A++-E



LED
INSIDE



Produktangaben

120-277V ~50/60Hz | 500mA
Systemleistung: 18W
Material: Aluminium / Glas

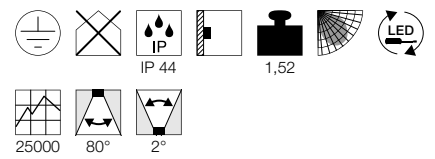

Maßzeichnung

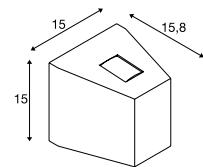

Variante	Art. Nr.
Flood: 690lm 3000K CRI>80 Beam: 50lm 3000K CRI>80 ■ grau / transparent	229664
Flood: 690lm 3000K CRI>80 Beam: 50lm 3000K CRI>80 ■ anthrazit	229665

ESKINA D
Display



A-A++ Spektrum A++-E



TODAY PRO
Display

A-A++ Spektrum A++-E



TODAY
Display

A-A++ Spektrum A++-E



• Lichtfarbe schaltbar

Produktangaben

220-240V ~50/60Hz | 350mA
Systemleistung: 14,5W
Material: Aluminium
Dimmbar: C

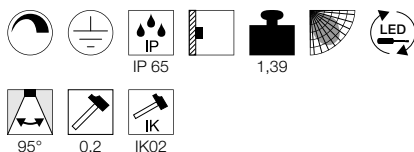

Produktangaben

220-240V ~50/60Hz | 640mA
Systemleistung: 29W
Material: Aluminium

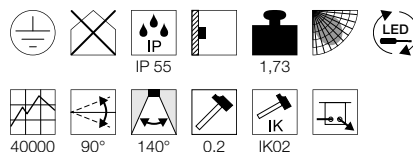

Produktangaben

220-240V ~50/60Hz | 640mA
Systemleistung: 29W
Material: Aluminium

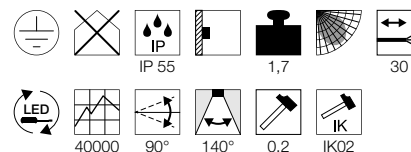

Maßzeichnung

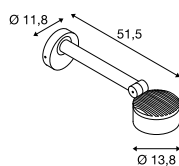

Maßzeichnung

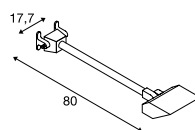

Maßzeichnung

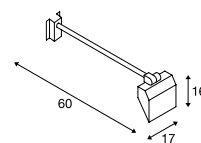

Hinweis

Offenes Kabelend

Variante	Art. Nr.
1000lm 3000/4000K CRI>80 ■ matt anthrazit	1002905

Variante	Art. Nr.
2800lm 4000K CRI>70 ■ schwarz	1000880
2800lm 4000K CRI>70 □ weiß	1000881
2800lm 4000K CRI>70 ■ grau	1000882

Variante	Art. Nr.
2800lm 4000K CRI>70 ■ schwarz	227700
2800lm 4000K CRI>70 □ weiß	227701



1000880 670



233134 671

MYRA DISPLAY
WL, straight, QPAR51



E-A++ Spektrum A++-E



Produktangaben

220-240V ~50/60Hz
Material: Aluminium



IP 55 0,69 340°

Maßzeichnung

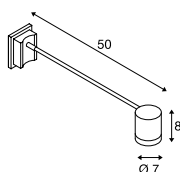

Zubehörempfehlung

■ Aufbaumontage Rahmen

Art. Nr. 233214

■ Aufbaumontage Rahmen

Art. Nr. 233215



Leuchtmittlempfehlung

LED GU10 7,2W 36°
4000K 540lm EEK=A+
8kWh/1000h

Art. Nr. 1001564



LED GU10 4,3W 40°
2700K 365lm EEK=A++
5kWh/1000h

Art. Nr. 560142



Leuchtmittelangaben

max. 50W QPAR51
Ø: 5 cm max. L: 5,7 cm max.

Variante	Art. Nr.
GU10 QPAR51	
■ grau	233124
GU10 QPAR51	
■ anthrazit	233125

MYRA DISPLAY
WL, curved, QPAR51



E-A++ Spektrum A++-E

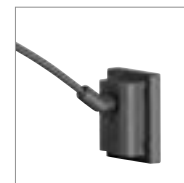

Produktangaben

220-240V ~50/60Hz
Material: Aluminium



IP 55 0,73 340°

Maßzeichnung

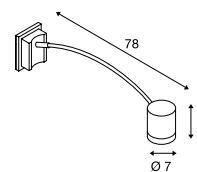

Zubehörempfehlung

■ Aufbaumontage Rahmen

Art. Nr. 233214

■ Aufbaumontage Rahmen

Art. Nr. 233215



Leuchtmittlempfehlung

GU10 5,5W 36°
2800K 420lm EEK=A+
6kWh/1000h

Art. Nr. 1001217



LED GU10 3,7W 36°
2700K 260lm EEK=A+
4kWh/1000h

Art. Nr. 560122



Leuchtmittelangaben

max. 50W QPAR51
Ø: 5 cm max. L: 5,7 cm max.

Variante	Art. Nr.
GU10 QPAR51	
■ grau	233134
GU10 QPAR51	
■ anthrazit	233135

PHOTONIA
CL, E27



E-A++ Spektrum A++-E



MOLAT
CL, E27



E-A++ Spektrum A+++-E



Produktangaben

220-240V ~50/60Hz
Material: Aluminium / Glas

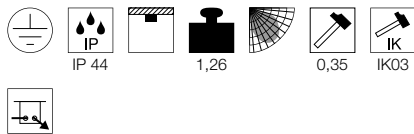

Maßzeichnung

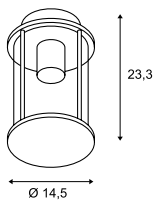

Produktangaben

230V ~50/60Hz
Material: Aluminium / Glas



Maßzeichnung

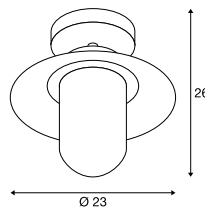

Leuchtmittlempfehlung

LED E27 7,1W 330°
2700K 806lm EEK=A+
8kWh/1000h
Art. Nr. 1001756



LED E27 5W 330°
2000K 500lm EEK=A+
5kWh/1000h
Art. Nr. 560741



Leuchtmittlempfehlung

LED E27 4,8W 330°
2700K 470lm EEK=A++
5kWh/1000h
Art. Nr. 560752



LED E27 4,5W 280°
2200-2700K 500lm EEK=A++
5kWh/1000h
Art. Nr. 1002125



Leuchtmittelangaben

max. 60W
Ø: 9 cm max. L: 15 cm max.

Leuchtmittelangaben

max. 60W
Ø: 6,5 cm max. L: 14,5 cm max.

Variante	Art. Nr.
E27	
■ anthrazit	232055

Variante	Art. Nr.
E27	
■ anthrazit	1000823



232055 672



1000823 672

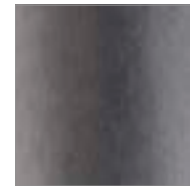

231361 673

LISENNE
CL, E27
 890
E-A++ Spektrum
A++-E

- Basaltstein & Rauchglas

Produktangaben

230V ~50/60Hz
Material: Basalt / Glas



IP 44

2,6

Maßzeichnung

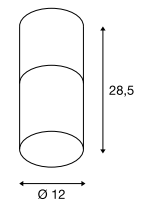

Leuchtmittelempfehlung

LED E27 7,1W 330°
2700K 806lm EEK=A+
8kWh/1000h
Art. Nr. 1001756



Leuchtmittelangaben

max. 23W
Ø: 5,9 cm max. L: 15 cm max.

Variante	Art. Nr.
E27 ■ grau / braun	231361

SITRA
CL, TCR-TSE

896

B-A++

Spektrum
A++-E

Produktangaben

230V ~50Hz
Material: Aluminium / Glas



IP 44



0,66

Maßzeichnung

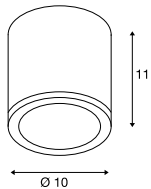

Leuchtmittlempfehlung

GX53 3W 120°
3000K 250lm EEK=A++
3kWh/1000h
Art. Nr. 551372



LED GX53 8,2W 120°
4000K 620lm EEK=A+
9kWh/1000h
Art. Nr. 550074



Leuchtmittelangaben

max. 9W TCR-TSE
Ø: 7,5 cm max. L: 3,5 cm max.

Variante	Art. Nr.
GX53 TCR-TSE	
<input type="checkbox"/> weiß	231541
GX53 TCR-TSE	
<input checked="" type="checkbox"/> anthrazit	231545



ENOLA C
CL



A-A++ Spektrum A++-E

LED INSIDE



ENOLA C
CL, TRIAC



A-A++ Spektrum A++-E

LED INSIDE



POLE PARC
CL



A-A++ Spektrum A++-E

LED INSIDE



- Premium LED mit CRI>90

Produktangaben

100-240V ~50/60Hz | 500mA
Systemleistung: 12W
Material: Aluminium / Glas

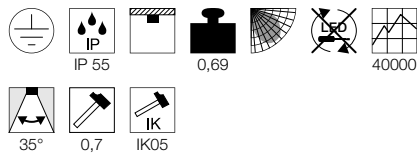

Maßzeichnung

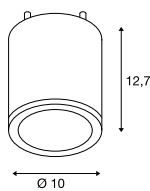

Produktangaben

220-240V ~50/60Hz | 350mA
Systemleistung: 15W
Material: Aluminium / Glas
Dimmbar: Triac C, Triac L

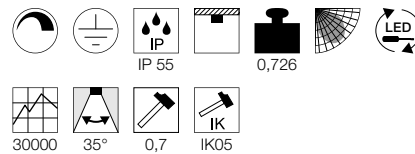

Maßzeichnung

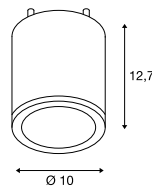

Produktangaben

100-240V ~50/60Hz | 700mA
Systemleistung: 28W
Material: Aluminium / Glas

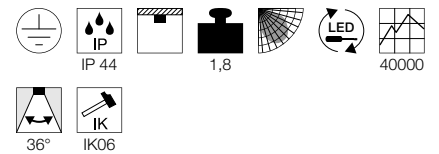

Maßzeichnung

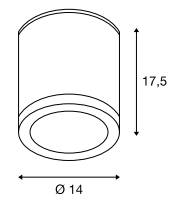

Variante	Art. Nr.
900lm 3000K CRI>80 ■ anthrazit	228505

Variante	Art. Nr.
725lm 2000-3000K CRI>90 ■ anthrazit	1002154

Variante	Art. Nr.
2900lm 3000K CRI>80 ■ anthrazit	1000447

ROX
CL, GX53



B-A++ Spektrum
A++-E



- Hochwertig gebürstete Oberfläche

Produktangaben

230V ~50Hz
Material: Aluminium / Glas

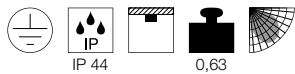

Maßzeichnung

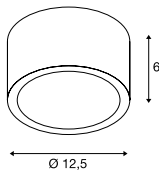

Leuchtmittlempfehlung

GX53 7,5W 25°
3000K 450lm EEK=A
8kWh/1000h
Art. Nr. 550082



LED GX53 7,5W 120°
4000K 620lm EEK=A+
8kWh/1000h
Art. Nr. 1001221



Leuchtmittelangaben

max. 11W TCR-TSE
Ø: 7,5 cm max. L: 3,5 cm max.

Variante	Art. Nr.
GX53 TCR-TSE ■ matt aluminium	1000339

ROX
CL, QPAR111



E-A++ Spektrum
A+++-E



- Hochwertig gebürstete Oberfläche

Produktangaben

230V ~50Hz
Material: Aluminium / Glas

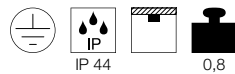

Maßzeichnung

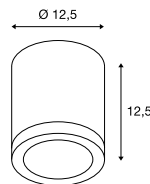

Leuchtmittlempfehlung

GU10 7,9W 25°
2700K 730lm EEK=A+
8kWh/1000h
Art. Nr. 560702



LED GU10 9W 25°
2700-6500K 765lm EEK=A+
9kWh/1000h
Art. Nr. 1001920



Leuchtmittelangaben

max. 50W QPAR111

Variante	Art. Nr.
GU10 QPAR111 ■ gebürstet aluminium	1000332

ROX ACRYL
CL, E27



A-A++ Spektrum
A++-E



- Hochwertig gebürstete Oberfläche

Produktangaben

230V ~50Hz
Material: Aluminium / Acryl

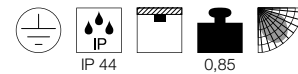

Maßzeichnung

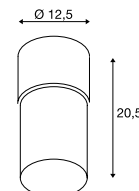

Leuchtmittlempfehlung

LED E27 9,1W 240°
2700K 760lm EEK=A+
10kWh/1000h
Art. Nr. 560402



LED E27 9W 240°
2700-6500K 806lm EEK=A+
9kWh/1000h
Art. Nr. 1001916



Leuchtmittelangaben

max. 20W
Ø: 6 cm max. L: 15 cm max.

Variante	Art. Nr.
E27 ■ matt aluminium	1000338



1000332 676



1000338 676

SQUARE C
CL, E27



A-A++ Spektrum A++-E

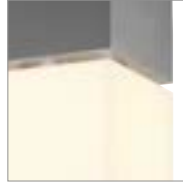

Produktangaben

220-240V ~50/60Hz
Material: Edelstahl 304

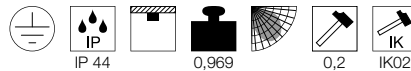

Maßzeichnung

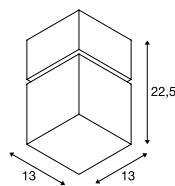

Leuchtmittlempfehlung

LED E27 7W 280°
2700K 790lm EEK=A++
7kWh/1000h
Art. Nr. 1002124



LED E27 9W 240°
3000K 810lm EEK=A+
10kWh/1000h
Art. Nr. 1001031



Leuchtmittelangaben

max. 20W
Ø: 7 cm max. L: 13 cm max.

Variante	Art. Nr.
E27 ■ edelstahl	1000337

SQUARE
CL, TRIAC



A-A++ Spektrum A++-E



Produktangaben

220-240V ~50/60Hz
Systemleistung: 12W
Material: Edelstahl 316
Dimmbar: Triac C, Triac L

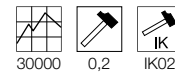

Maßzeichnung

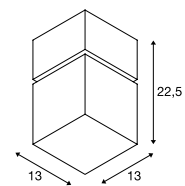

Variante	Art. Nr.
760lm 3000K CRI>80 ■ edelstahl	1000835

THEO
CL, QPAR51



E-A++ Spektrum A++-E

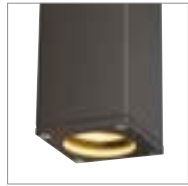
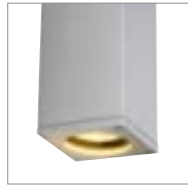

BIG THEO
CL



A-A++ Spektrum A+++-E

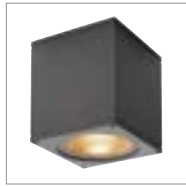

BIG THEO
CL, QPAR111



E-A++ Spektrum A++-E

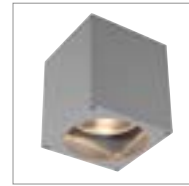

Produktangaben

230V ~50Hz
Material: Aluminium / Glas

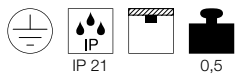

Produktangaben

100-277V ~50/60Hz | 500mA
Systemleistung: 21W
Material: Aluminium / Glas

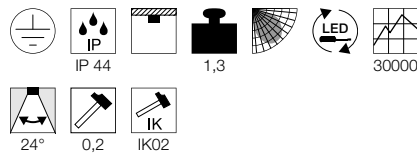

Produktangaben

230V ~50Hz
Material: Aluminium / Glas

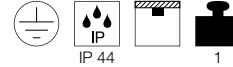

Maßzeichnung

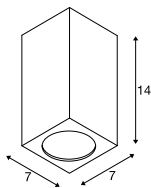

Maßzeichnung

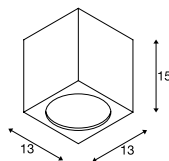

Maßzeichnung

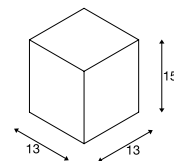

Leuchtmittlempfehlung

LED GU10 7,2W 36°
3000K 520lm EEK=A+
8kWh/1000h
Art. Nr. 1001561



LED GU10 7,2W 36°
4000K 540lm EEK=A+
8kWh/1000h
Art. Nr. 1001564



Leuchtmittelangaben

max. 35W QPAR51
Ø: 5 cm max. L: 6,8 cm max.

Variante	Art. Nr.
GU10 QPAR51	
□ weiß	229581
GU10 QPAR51	
■ grau / transparent	229584
GU10 QPAR51	
■ anthrazit	229585

Leuchtmittlempfehlung

GU10 7W 13°
3000K 660lm EEK=A+
8kWh/1000h
Art. Nr. 1001568



LED GU10 7,9W 40°
4000K 760lm EEK=A+
8kWh/1000h
Art. Nr. 560734



Leuchtmittelangaben

max. 75W QPAR111

Variante	Art. Nr.
GU10 QPAR111	
□ weiß	229551
GU10 QPAR111	
■ grau / transparent	229554
GU10 QPAR111	
■ anthrazit	229555



1002157 679



DESIGNED BY
Philippe Stephant *Philippe Stephant*

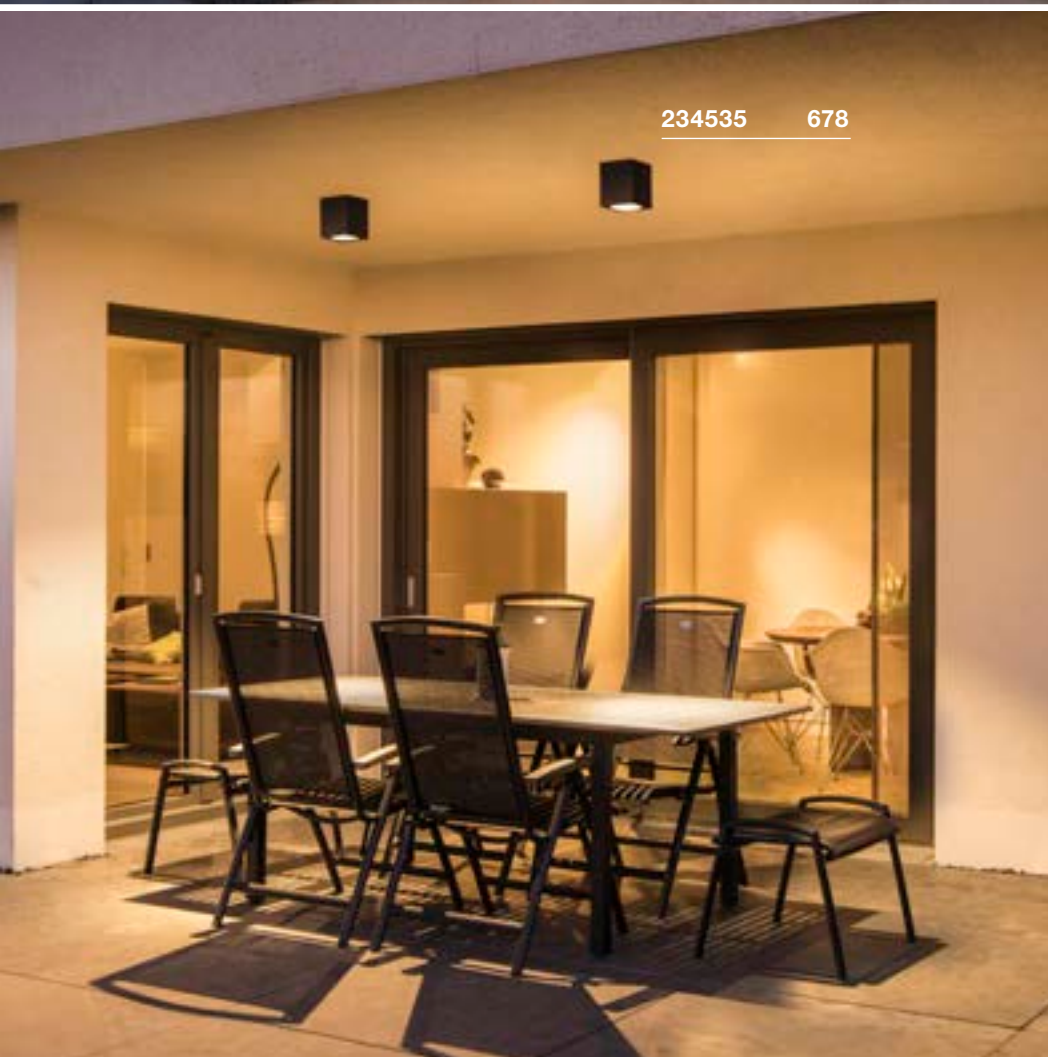

234535 678

MALU
CL

890

A-A++ Spektrum A++-E



reddot award 2019 winner



- Außergewöhnliches Design
- Gleichmäßige Ausleuchtung

Produktangaben

220-240V ~50/60Hz
Systemleistung: 9,2W
Material: Aluminium / Glas

100°	50°	IK03	100	

Maßzeichnung

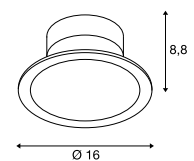

Variante	Art. Nr.
360lm 3000K CRI>80 ■ anthrazit	1002157

AINOS
CW

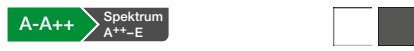

AINOS
CW SENSOR

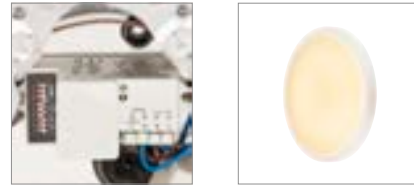

- Bewegungsmelder mit Mikrowellen-Technik im Leuchtengehäuse integriert

Produktangaben

100-277V ~50/60Hz | 500mA
Systemleistung: 21W
Material: Aluminium / Polycarbonat (PC)

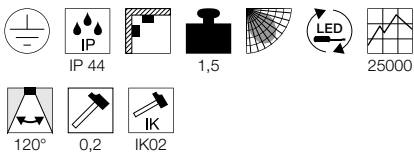

Maßzeichnung

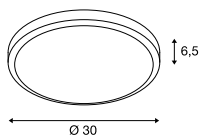

Produktangaben

100-277V ~50/60Hz | 500mA
Systemleistung: 22W
Material: Aluminium / Polycarbonat (PC)

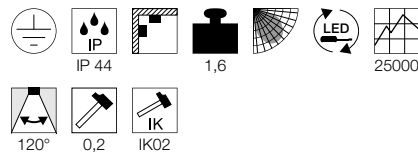

Maßzeichnung

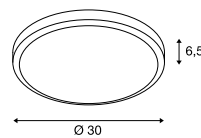

Hinweis

Bewegungssensor: Der Erfassungswinkel des Sensors beträgt 360°. Die Erfassungsdistanz, Einschaltumgebungs-helligkeit und Einschalt-dauer können eingestellt werden.

Variante	Art. Nr.
1430lm 3000K CRI>80	
□ weiß	229961
1430lm 3000K CRI>80	
■ anthrazit	229965

Variante	Art. Nr.
1430lm 3000K CRI>80	
□ weiß	229971
1430lm 3000K CRI>80	
■ anthrazit	229975

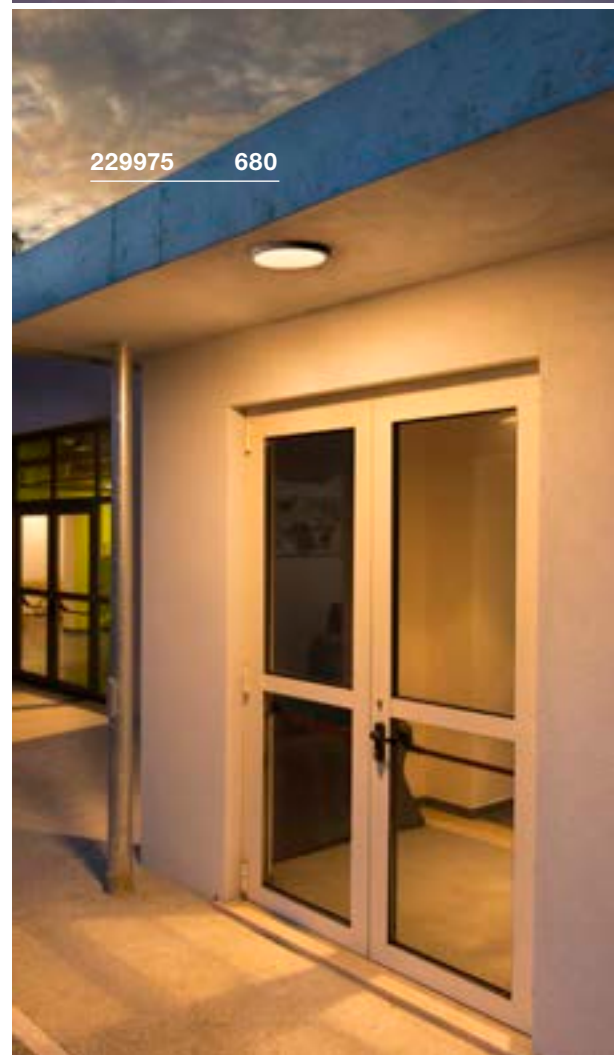



1001909/10/11 681

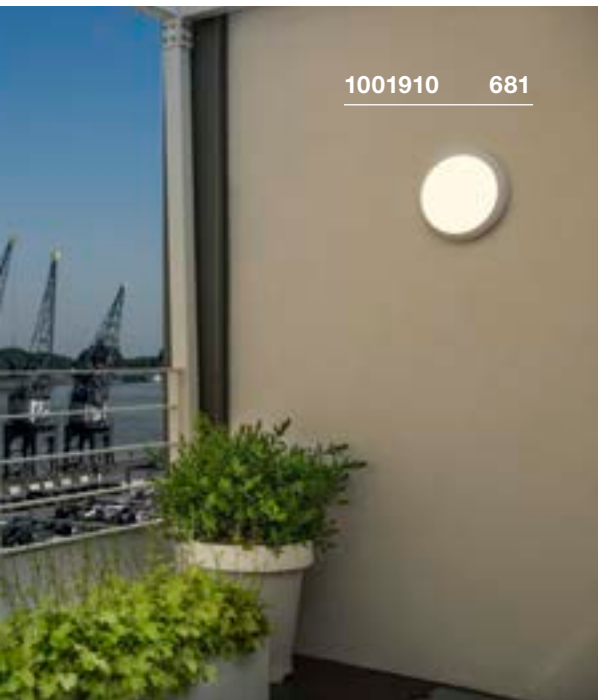

1001910 681



1001913 681

RUBA 10/16/20
CW

A-A++ Spektrum A++-E

LED INSIDE



- Die Lichtfarbe ist bei der Installation durch einen Schalter einstellbar

Produktangaben

220-240V ~50/60Hz | 600mA
Material: Polycarbonat (PC)

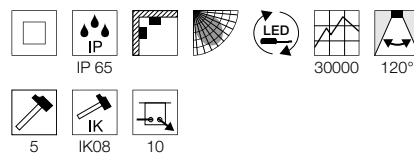

Maßzeichnung

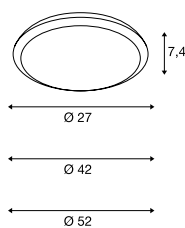

Variante	Art. Nr.
1050lm 3000/4000K CRI>80 13W Ø: 27 cm 0,8 kg ☐ weiß	1001909
2230lm 3000/4000K CRI>80 24W Ø: 42 cm 1,1 kg ☐ weiß	1001910
2500lm 3000/4000K CRI>80 27W Ø: 52 cm 1,6 kg ☐ weiß	1001911

RUBA 10/16/20
CW, Sensor

A-A++ Spektrum A++-E

LED INSIDE



- Die Lichtfarbe ist bei der Installation durch einen Schalter einstellbar
- Bewegungsmelder mit Mikrowellen-Technik im Leuchtgehäuse integriert

Produktangaben

220-240V ~50/60Hz | 700mA
Material: Polycarbonat (PC)

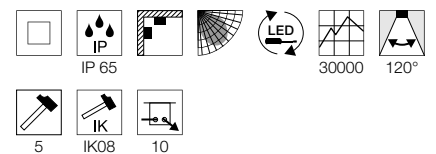

Maßzeichnung

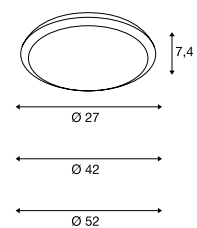

Variante	Art. Nr.
1050lm 3000/4000K CRI>80 13W Ø: 27 cm 0,8 kg ☐ weiß	1001912
2230lm 3000/4000K CRI>80 24W Ø: 42 cm 1,1 kg ☐ weiß	1001913
2500lm 3000/4000K CRI>80 27W Ø: 52 cm 1,6 kg ☐ weiß	1001914

BULAN GRID
CW, E27

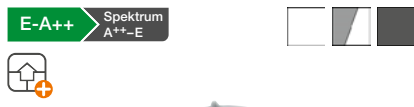

• Sichtliches Design für vielfältige Anwendungsbereiche

Produktangaben

230V ~50Hz
Material: Aluminium / Polycarbonat (PC)

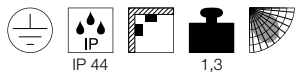

Maßzeichnung

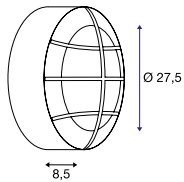

Leuchtmittlempfehlung

E27 9W 240°
3000K 810lm EEK=A+
10kWh/1000h
Art. Nr. 1001031



LED E27 15W 240°
3000K 1521lm EEK=A+
15kWh/1000h
Art. Nr. 1001033



Leuchtmittelangaben

2x max. 25W
Ø: 5,2 cm max. L: 17,3 cm max.

Variante	Art. Nr.
E27	
□ weiß	229081
E27	
■ grau / matt transparent	229084
E27	
■ anthrazit	229085

BULAN
CW, E14

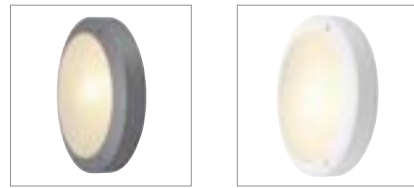
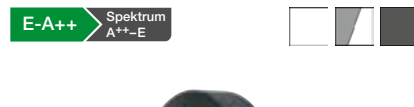

Produktangaben

230V ~50Hz
Material: Aluminium / Glas

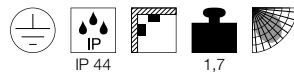

Maßzeichnung

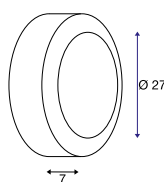

Leuchtmittlempfehlung

LED E14 6,5W 280°
3000K 480lm EEK=A+
7kWh/1000h
Art. Nr. 560372



Leuchtmittelangaben

max. 60W C35
Ø: 4,8 cm max. L: 13 cm max.

Variante	Art. Nr.
E14 C35	
□ weiß	229071
E14 C35	
■ grau / transparent	229072
E14 C35	
■ anthrazit	229075





229085 682



1001856 683

LIPA
CW, TRIAC

A-A++ Spektrum
A++-E



LED
INSIDE



- Farbtemperatur 3000K oder 4000K über Schalter einstellbar
- außergewöhnliches Design

Produktangaben

220-240V ~50/60Hz | 500mA
Systemleistung: 24W
Material: Aluminium / Polycarbonat (PC)
Dimmbar: Triac C

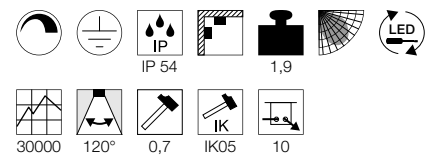

Maßzeichnung

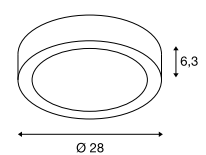

Variante	Art. Nr.
1600lm 3000/4000K CRI>80	
□ weiß	1001855
1500lm 3000/4000K CRI>80	
■ anthrazit	1001856

TERANG 200
CW

A-A++ Spektrum A++-E

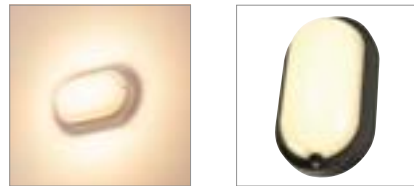
- Hochvolt LED

Produktangaben

220-240V ~50Hz
Systemleistung: 11W
Material: Aluminium / Polycarbonat (PC)

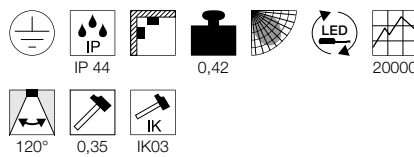

Maßzeichnung

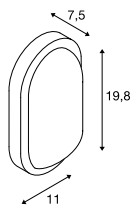

TERANG 270
CW

A-A++ Spektrum A++-E

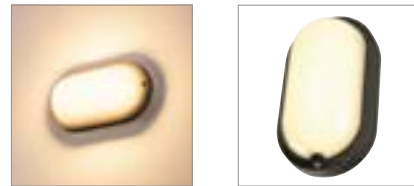
- Hochvolt LED

Produktangaben

220-240V ~50Hz
Systemleistung: 22W
Material: Aluminium / Polycarbonat (PC)

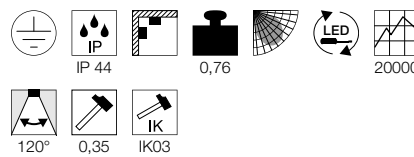

Maßzeichnung

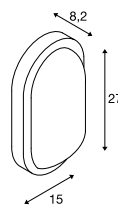

TERANG 270
CW SENSOR

A-A++ Spektrum A++-E





- Hochvolt LED
- Bewegungsmelder mit Mikrowellen-Technik im Leuchtengehäuse integriert

Produktangaben

220-240V ~50Hz
Systemleistung: 23W
Material: Aluminium / Polycarbonat (PC)

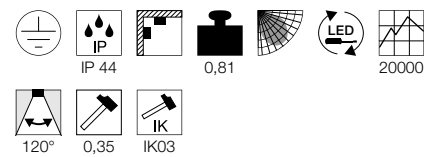

Maßzeichnung

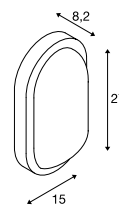

Hinweis

Bewegungssensor: Der Erfassungswinkel des Sensors beträgt 360°. Die Erfassungsdistanz, Einschaltumgebungshelligkeit und Einschaltdauer können eingestellt werden.

Variante	Art. Nr.
680lm 3000K CRI>80 □ weiß	229931
680lm 3000K CRI>80 ■ anthrazit	229935

Variante	Art. Nr.
1300lm 3000K CRI>80 □ weiß	229941
1300lm 3000K CRI>80 ■ anthrazit	229945

Variante	Art. Nr.
1300lm 3000K CRI>80 □ weiß	229951
1300lm 3000K CRI>80 ■ anthrazit	229955



229955 684

1001316 687

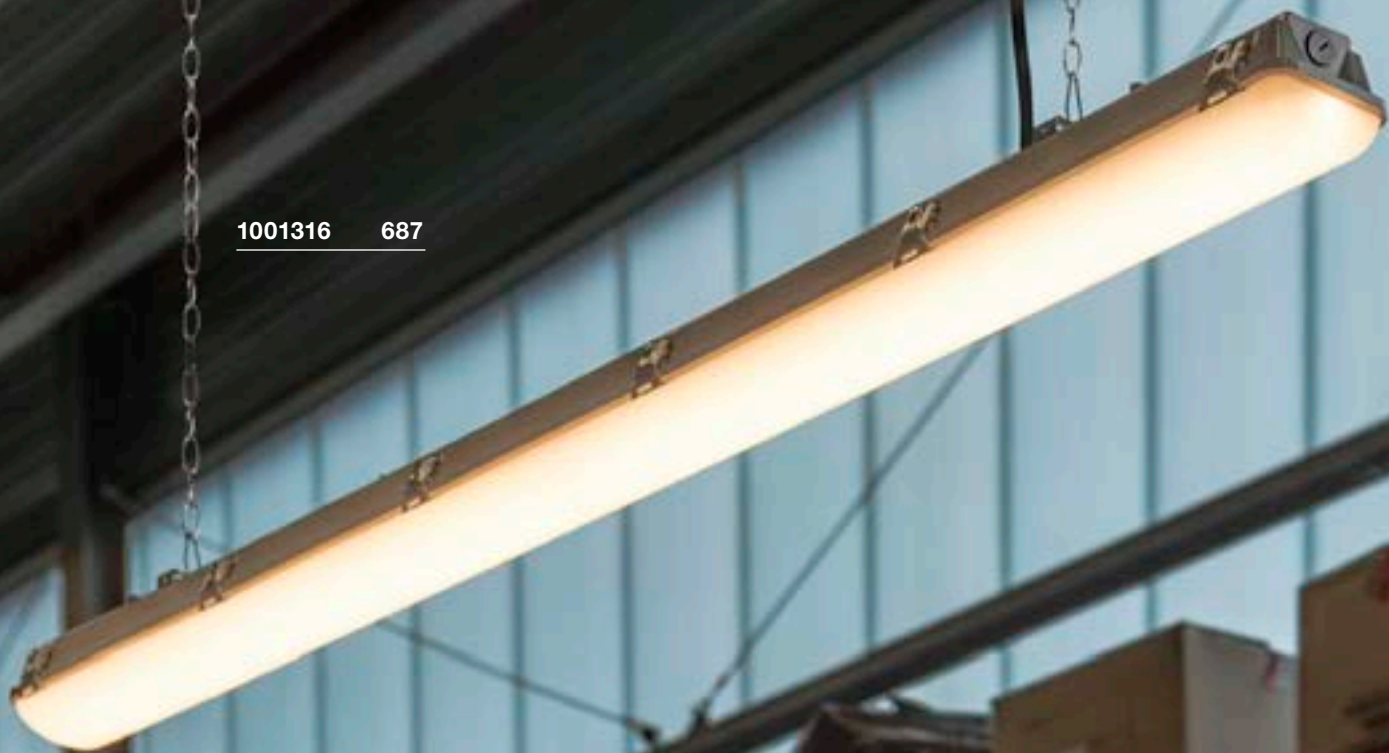

IMPERVA 120
CW

A-A++ Spektrum A++-E



- Hohe IP-Schutzart
- Besonders widerstandsfähiges Leuchtgehäuse

Produktangaben

220-240V ~50/60Hz | 700mA
Systemleistung: 40W
Material: Polycarbonat (PC)

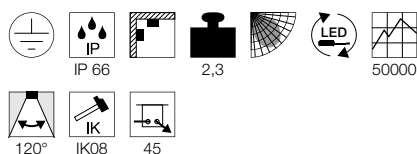

Maßzeichnung

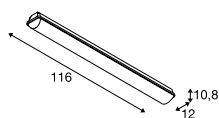

Hinweis

Kette exkl.

IMPERVA 150
CW

A-A++ Spektrum A++-E

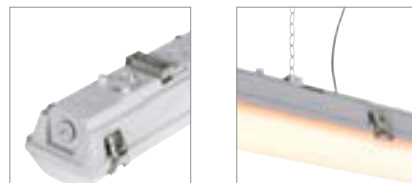

- Hohe IP-Schutzart
- Besonders widerstandsfähiges Leuchtgehäuse

Produktangaben

220-240V ~50/60Hz | 1050mA
Systemleistung: 55W
Material: Polycarbonat (PC)

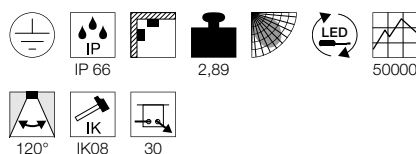

Maßzeichnung

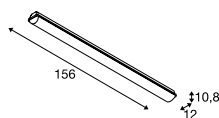

Hinweis

Kette exkl.

ALMINO
PD, quad, UGR<19



A-A++ Spektrum A++-E



- Besonders gut geeignet für Industriebereiche, Lager- und Logistik
- Effiziente Grundbeleuchtung mit begrenzter Direktblendung, UGR< 19
- Besonders widerstandsfähiges Gehäuse

Produktangaben

220-240V ~50/60Hz | 1200mA
Systemleistung: 190W
Material: Stahl / Polycarbonat (PC)

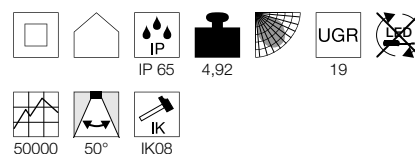

Maßzeichnung

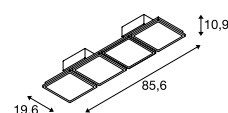

Zubehörempfehlung

- Abhängeset 3m
Art. Nr. 1002196
- Montage Bügel
Art. Nr. 1002197



Variante	Art. Nr.
4200lm 3000K CRI>80 ■ grau	1001314
4600lm 4000K CRI>80 ■ grau	1001315

Variante	Art. Nr.
6600lm 3000K CRI>80 ■ grau	1001316
7100lm 4000K CRI>80 ■ grau	1001317

Variante	Art. Nr.
24000lm 4000K CRI>80 ■ grau / weiß	1002194

NAUTILUS 25
CL
 892

 A-A++  Spektrum
A++-E

 NEW

1002867 688



Produktangaben

 220-240V ~50/60Hz
 Material: Aluminium

IP 54



0,7



0,2



IK02

Maßzeichnung

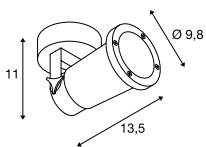

231055 689

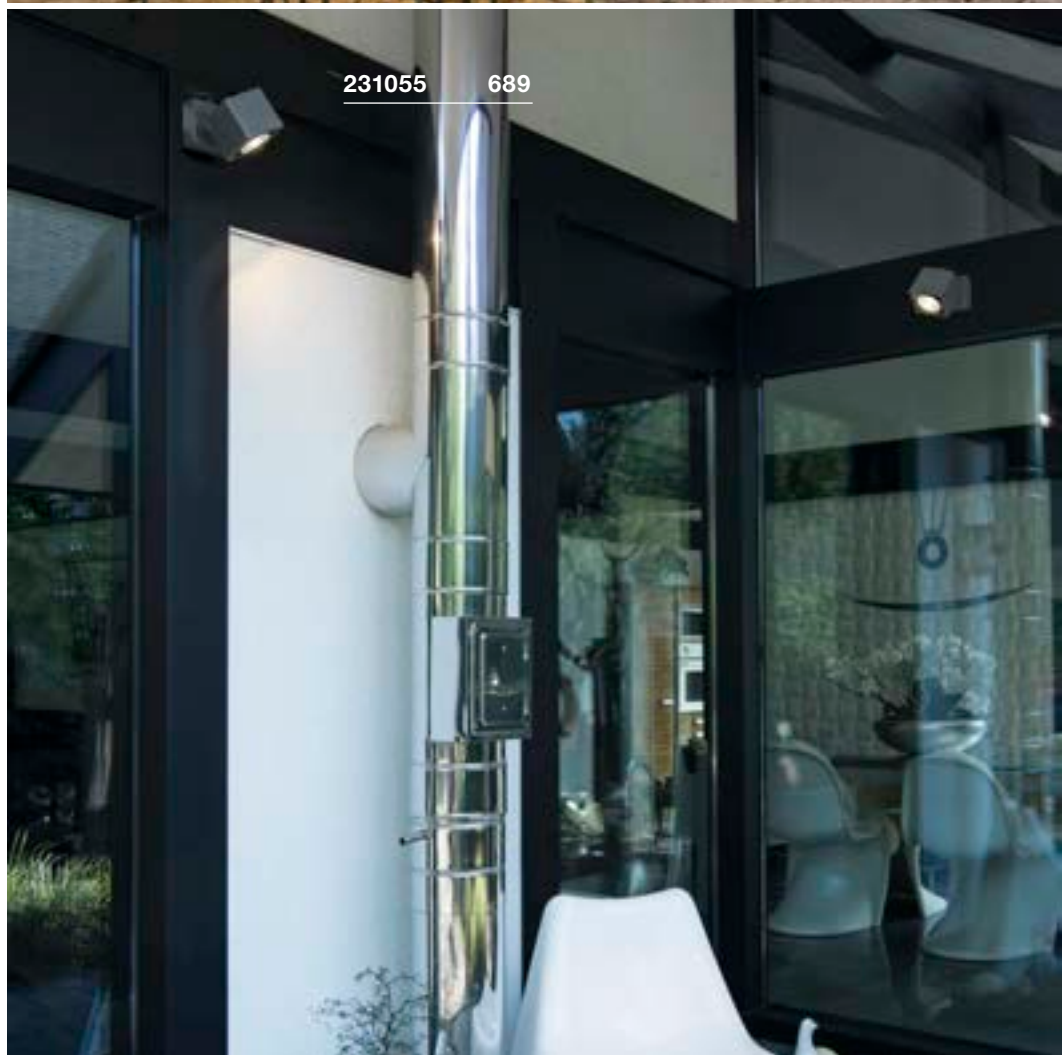

Zubehörempfehlung

 ■ Montageplatte
 Art. Nr. 1002884

Leuchtmittelangaben

 max. 11W
 Ø: 5 cm max. L: 8,3 cm max.

Variante	Art. Nr.
GU10	
■ matt schwarz	1002867 

NAUTILUS
WL, square



A-A++ Spektrum A++-E



NAUTILUS 10
WL, square



A-A++ Spektrum A++-E



ESKINA SPOT/
SPOT SENSOR
CW



A-A++ Spektrum A++-E



- Lichtfarbe schaltbar
- 1002904 mit Infrarot Bewegungssensor

Produktangaben

100-240V ~50/60Hz | 700mA
Systemleistung: 9W
Material: Aluminium / Glas

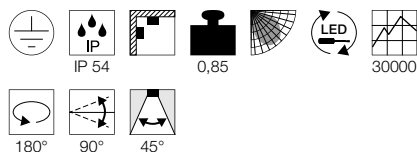

Maßzeichnung

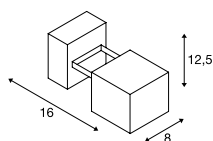

Produktangaben

100-277V ~50/60Hz | 350mA
Systemleistung: 17W
Material: Aluminium / Glas

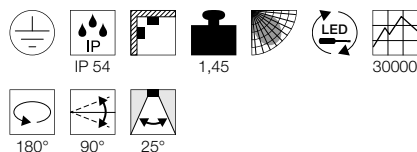

Maßzeichnung

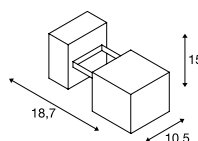

Produktangaben

220-240V ~50/60Hz | 350mA
Systemleistung: 14,5W
Material: Aluminium
Dimmbar: Triac C

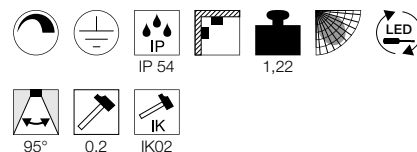

Maßzeichnung

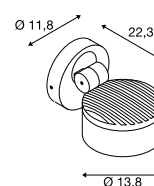

Hinweis

1002904 – Bewegungsmelder:
Erfassungswinkel: 100°
Erfassungsdistanz: max. 10m
Die Einschaltumgebungshelligkeit und Einschaltdauer können eingestellt werden.

Variante	Art. Nr.
520lm 3000K CRI>80 ■ anthrazit	231045

Variante	Art. Nr.
950lm 3000K CRI>80 ■ anthrazit	231055

Variante	Art. Nr.
1000lm 3000/4000K CRI>80 ■ matt anthrazit	1002903
1000lm 3000/4000K CRI>80 ■ matt anthrazit	1002904

SITRA 360
CW, TCR-TSE



B-A++ Spektrum A++-E



MYRA
CW, single, QPAR51



E-A++ Spektrum A++-E

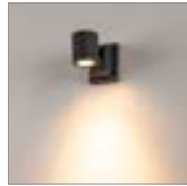

MYRA
WL, double, QPAR51



E-A++ Spektrum A++-E



Produktangaben

230V ~50Hz
Material: Aluminium / Glas

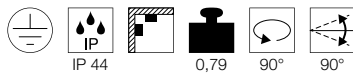

Maßzeichnung

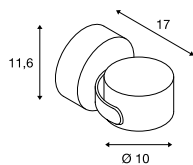

Produktangaben

230V ~50Hz
Material: Aluminium / Glas

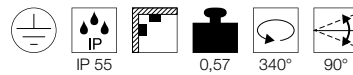

Maßzeichnung

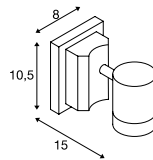

Hinweis

Adapterrahmen zur Aufputzmontage erhältlich

Zubehörempfehlung

■ Aufbaumontage Rahmen
Art. Nr. 233214

■ Aufbaumontage Rahmen
Art. Nr. 233215

Leuchtmittlempfehlung

GX53 3W 120°
3000K 250lm EEK=A++
3kWh/1000h
Art. Nr. 551372



LED GX53 8,2W 120°
4000K 620lm EEK=A+
9kWh/1000h
Art. Nr. 550074



Leuchtmittelangaben

max. 9W TCR-TSE
Ø: 7,5 cm max. L: 3,5 cm max.

Variante	Art. Nr.
GX53 TCR-TSE ■ anthrazit	231515

Leuchtmittlempfehlung

LED GU10 7,2W 36°
4000K 540lm EEK=A+
8kWh/1000h
Art. Nr. 1001565



LED GU10 7,2W 36°
2700K 520lm EEK=A+
8kWh/1000h
Art. Nr. 1001560



Leuchtmittelangaben

max. 50W QPAR51
Ø: 5 cm max. L: 5,7 cm max.

Variante	Art. Nr.
GU10 QPAR51 ■ grau / transparent	233104
GU10 QPAR51 ■ anthrazit	233105

Produktangaben

220-240V ~50/60Hz
Material: Aluminium / Glas

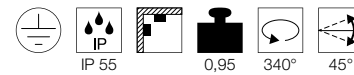

Maßzeichnung

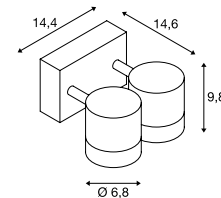

Hinweis

Adapterrahmen zur Aufputzmontage erhältlich

Zubehörempfehlung

■ Aufbaumontage Rahmen
Art. Nr. 233214

■ Aufbaumontage Rahmen
Art. Nr. 233215

Leuchtmittlempfehlung

LED GU10 5,5W 38°
2700K 400lm EEK=A+
6kWh/1000h
Art. Nr. 1001030



LED GU10 7,2W 36°
3000K 520lm EEK=A+
8kWh/1000h
Art. Nr. 1001562



Leuchtmittelangaben

2x max. 50W QPAR51
Ø: 5 cm max. L: 5,7 cm max.

Variante	Art. Nr.
GU10 QPAR51 ■ grau / transparent	233094
GU10 QPAR51 ■ anthrazit	233095

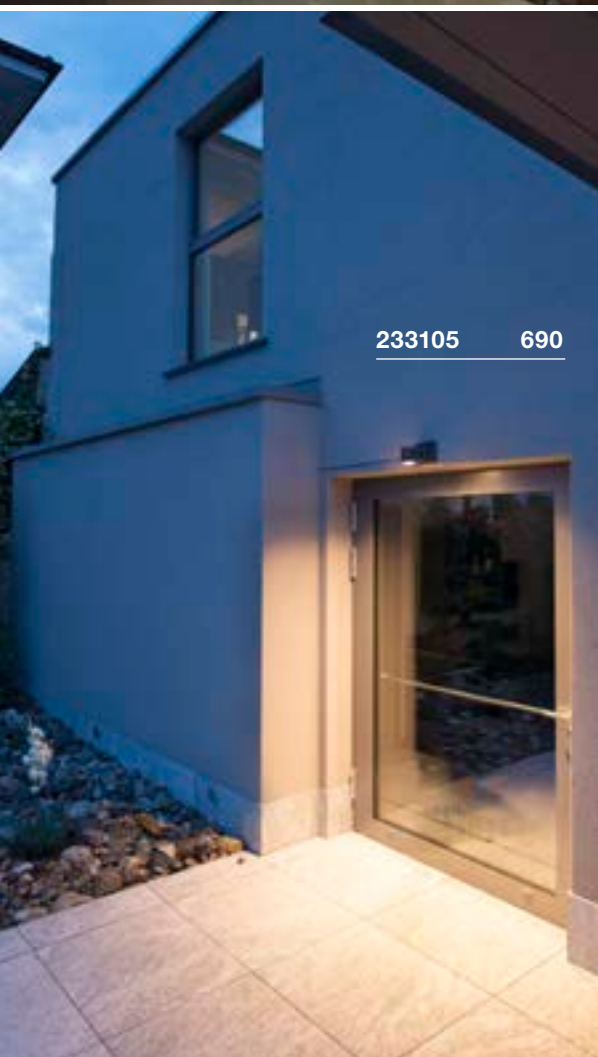

HELIA
CW, single, TRIAC



A-A++ Spektrum
A++-E

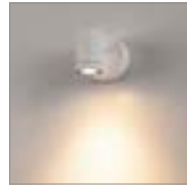

• Hochvolt LED

Produktangaben

220-240V ~50/60Hz
Systemleistung: 8W
Material: Aluminium / Glas
Dimmbar: Triac C, Triac L

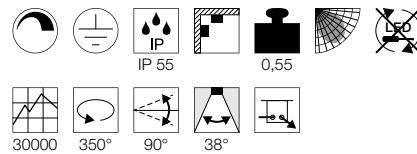

Maßzeichnung

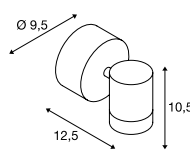

HELIA
CW, double, TRIAC



A-A++ Spektrum
A++-E

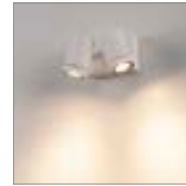

• Hochvolt LED

Produktangaben

220-240V ~50/60Hz
Systemleistung: 16W
Material: Aluminium / Glas
Dimmbar: Triac C, Triac L

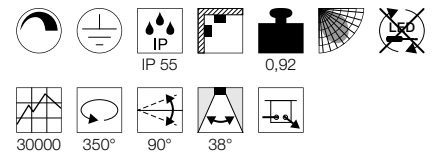

Maßzeichnung

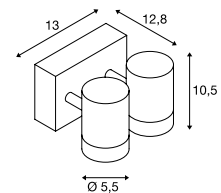

Variante	Art. Nr.
450lm 3000K CRI>80	
■ anthrazit	233245
450lm 3000K CRI>80	
□ weiß	233241

Variante	Art. Nr.
900lm 3000K CRI>80	
■ anthrazit	233255
900lm 3000K CRI>80	
□ weiß	233251

HART IM NEHMEN.

EINBAULEUCHTEN BRINGEN LICHT MIT SICHERHEIT.

Einbauleuchten sind gerade im Outdoor-Bereich eine gute Alternative zu freihängenden Leuchten, denn sie sind individuell einstellbar, können statisch gesetzt, gerichtet oder geflügelt werden. Und sie sind gegen jedes Wetter gewappnet: dank hochwertiger Ausführung und Materialien sowie individueller IP-Schutzarten.

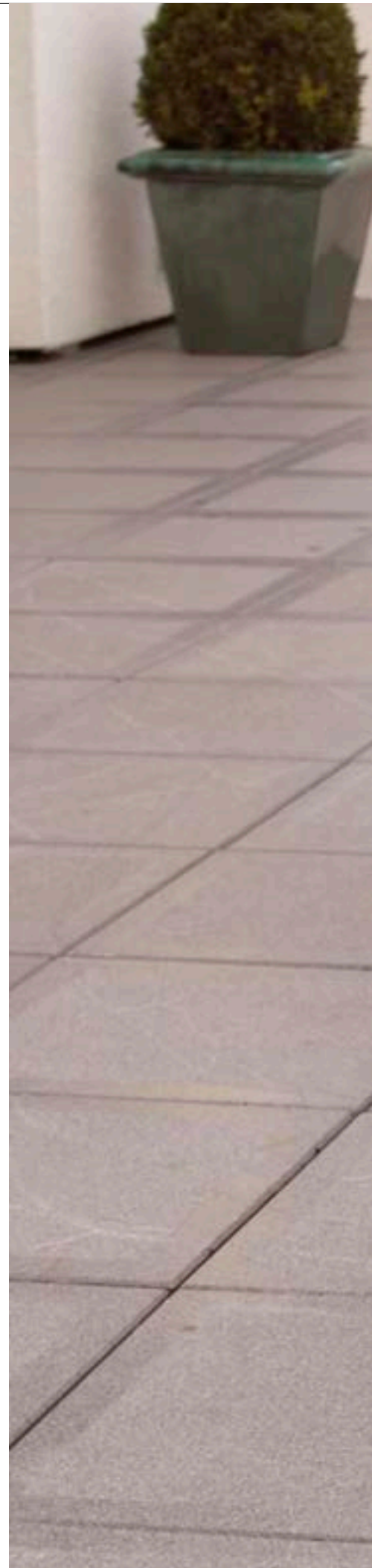



228412 722



227604 719



EINBAULEUCHTEN

 698	 698	 699	 699	 699	 700	 701	 701
 701	 705	 705	 705	 706	 706	 707	 707
 708	 708	 709	 709	 710	 710	 711	 711
 711	 714	 715	 715	 715	 716	 717	 717
 718	 719	 719	 719	 720	 721	 721	 721
 722	 723	 725	 725	 725	 726	 727	 727
 727	 729	 729	 729	 730	 730	 730	 733
 733	 733	 734	 734				

WANDEINBAULEUCHTEN

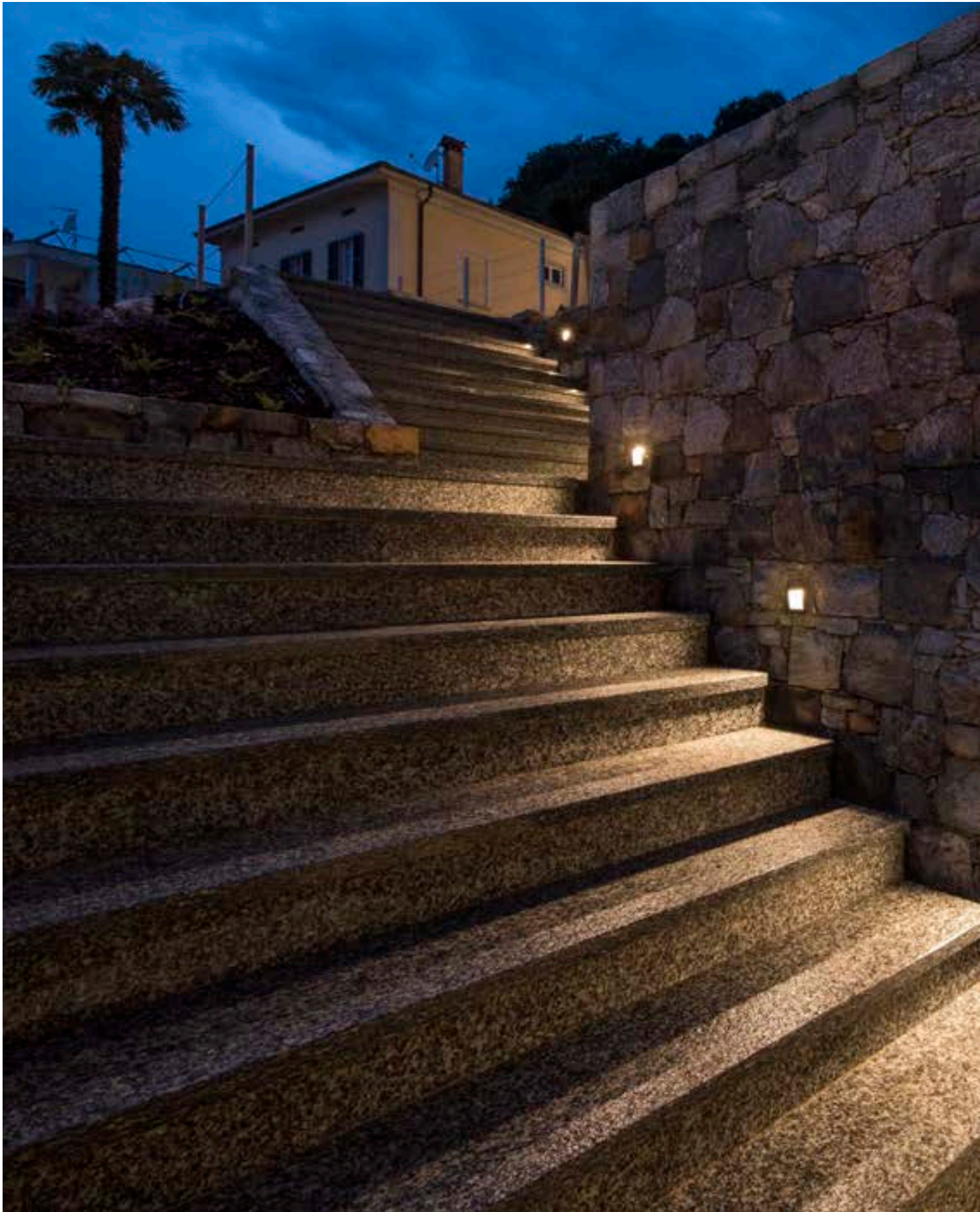

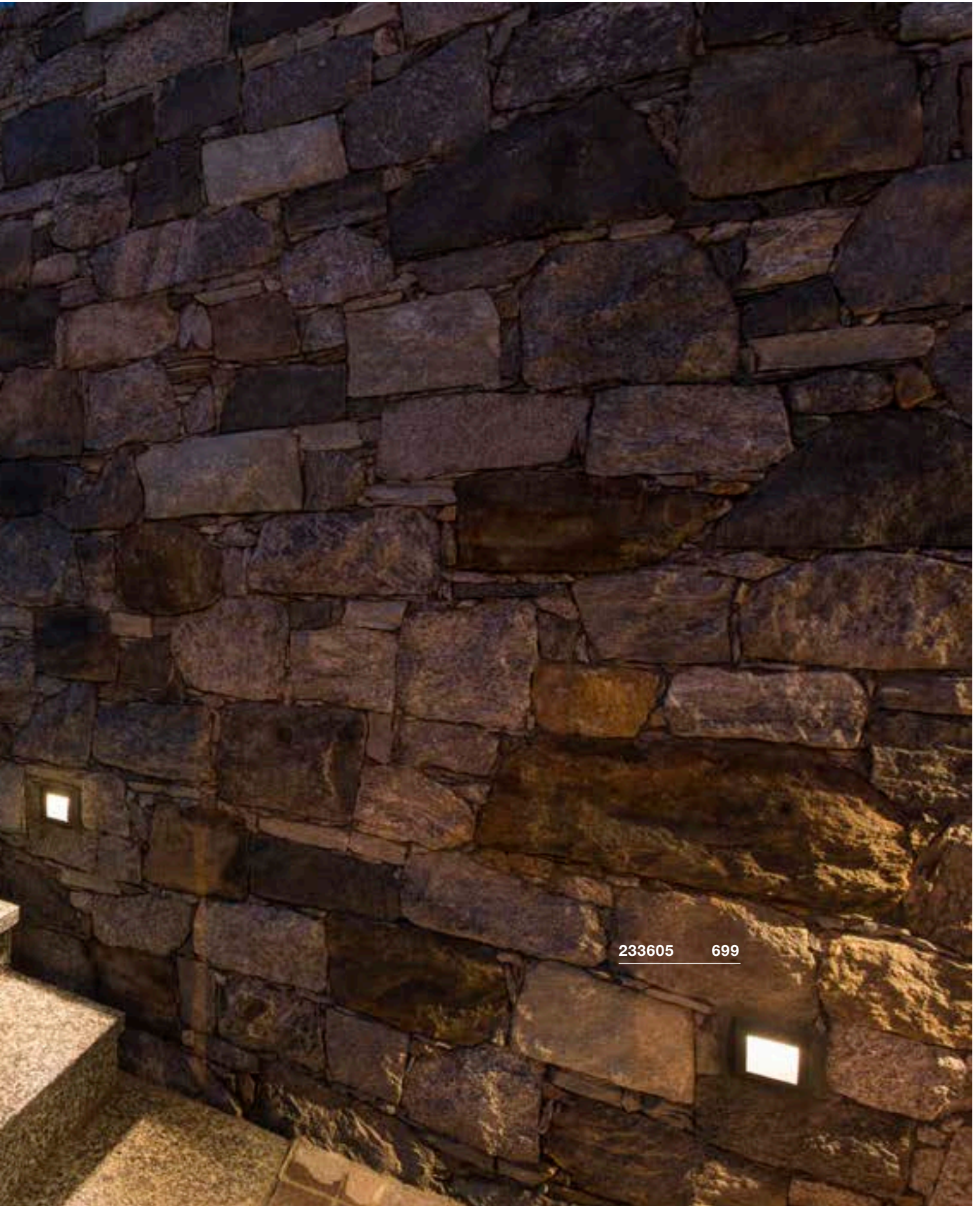

233605 699

BRICK DOWNUNDER
EL, E14

E-A++ Spektrum A++-E



BRICK DOWNUNDER
EL

A-A++ Spektrum A++-E



Produktangaben

230V ~50Hz
Material: Aluminium / Glas

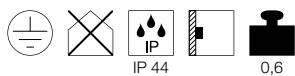

Produktangaben

230V ~50Hz
Systemleistung: 1,4W
Material: Aluminium / Glas

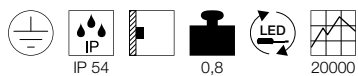

Maßzeichnung

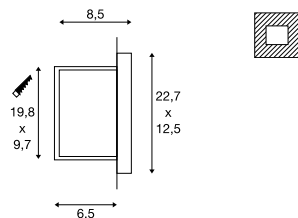

Hinweis

Kein Einbautopf erforderlich.

Maßzeichnung

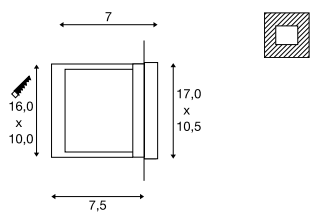

Hinweis

Einbautopf inkl.

Leuchtmittlempfehlung

E14 3,4W 260°
3000K 250lm EEK=A+
4kWh/1000h
Art. Nr. 560362



LED E14 6,5W 280°
3000K 480lm EEK=A+
7kWh/1000h
Art. Nr. 560372



Leuchtmittelangaben

max. 40W C35
Ø: 4,3 cm max. L: 12 cm max.

Variante	Art. Nr.
E14 C35 ■ grau / transparent	229062

Variante	Art. Nr.
30lm 3000K CRI>80 ■ grau / transparent	229702



229702 698



233615 699



DOWNUNDER OUT S EL

A-A++ Spektrum A++-E

LED INSIDE



Produktangaben

220-240V ~50/60Hz | 20mA
 Systemleistung: 1,7W
 Material: Aluminium / Kunststoff



Maßzeichnung

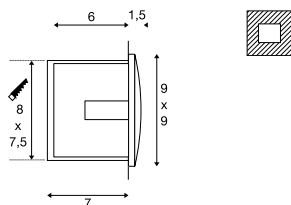

Hinweis

Leuchte nur mit Lichtaustritt nach unten montieren. Max. Ø Anschlusskabel 8,5 mm. Einbautopf inkl.

DOWNUNDER OUT M EL

A-A++ Spektrum A++-E

LED INSIDE



Produktangaben

220-240V ~50/60Hz | 20mA
 Systemleistung: 3,3W
 Material: Aluminium / Kunststoff



Maßzeichnung

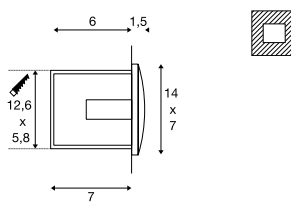

Hinweis

Leuchte nur mit Lichtaustritt nach unten montieren. Max. Ø Anschlusskabel 8,5 mm. Einbautopf inkl.

DOWNUNDER OUT L EL

A-A++ Spektrum A++-E

LED INSIDE



Produktangaben

220-240V ~50/60Hz | 20mA
 Systemleistung: 3,3W
 Material: Aluminium / Kunststoff



Maßzeichnung

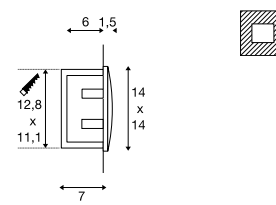

Hinweis

Leuchte nur mit Lichtaustritt nach unten montieren. Max. Ø Anschlusskabel 8,5 mm. Einbautopf inkl.

Variante	Art. Nr.
40lm 3000K CRI>80	
□ weiß	233601
25lm 3000K CRI>80	
■ anthrazit	233605

Variante	Art. Nr.
155lm 3000K CRI>80	
□ weiß	233621
85lm 3000K CRI>80	
■ anthrazit	233625

Variante	Art. Nr.
155lm 3000K CRI>80	
□ weiß	233611
85lm 3000K CRI>80	
■ anthrazit	233615

ADI
EL

A-A++ Spektrum A++-E

LED
INSIDE



233635 700

Produktangaben

100-277V ~50/60Hz | 500mA
Systemleistung: 18W
Material: Aluminium / Polycarbonat (PC)

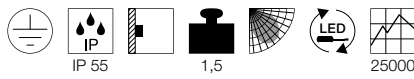

Maßzeichnung

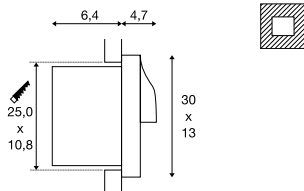

Hinweis

Leuchte nur mit Lichtaustritt nach unten montieren.



233650 701

Zubehörempfehlung

Einbautopf
Art. Nr. 233639

Variante	Art. Nr.
870lm 3000K CRI>80 ■ anthrazit	233635



BRICK MESH
EL

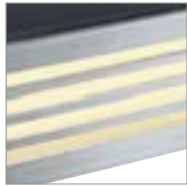

- Blende: Edelstahl 316

Produktangaben

100-240V ~50/60Hz | 24V DC
Systemleistung: 3,7W
Material: Edelstahl 316 / Glas



Maßzeichnung

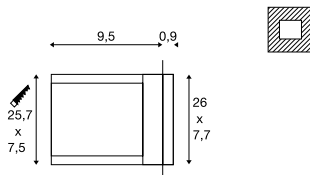

Hinweis

Einbautopf inkl.

Variante	Art. Nr.
52lm 3000K CRI>80 ■ edelstahl	229110

BRICK
EL, symmetrisch



- Symmetrischer Lichtaustritt
- Blende Edelstahl 316L Gehäuse Aluminium

Produktangaben

220-240V ~50/60Hz | 700mA
Systemleistung: 11W
Material: Aluminium / Edelstahl 316

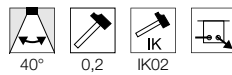

Maßzeichnung

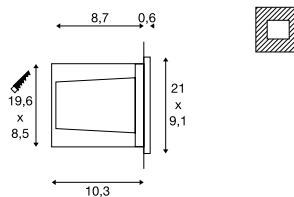

Hinweis

Einbautopf inkl.

Variante	Art. Nr.
950lm 3000K CRI>80 ■ edelstahl	233650

BRICK
EL, asymmetrisch



- Asymmetrischer Lichtaustritt
- Blende Edelstahl 316L Gehäuse Aluminium

Produktangaben

220-240V ~50/60Hz | 700mA
Systemleistung: 11W
Material: Aluminium / Edelstahl 316



Maßzeichnung

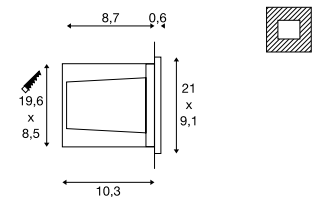

Hinweis

Einbautopf inkl.

Variante	Art. Nr.
850lm 3000K CRI>80 ■ edelstahl	233660

DECKENEINBAULEUCHTEN

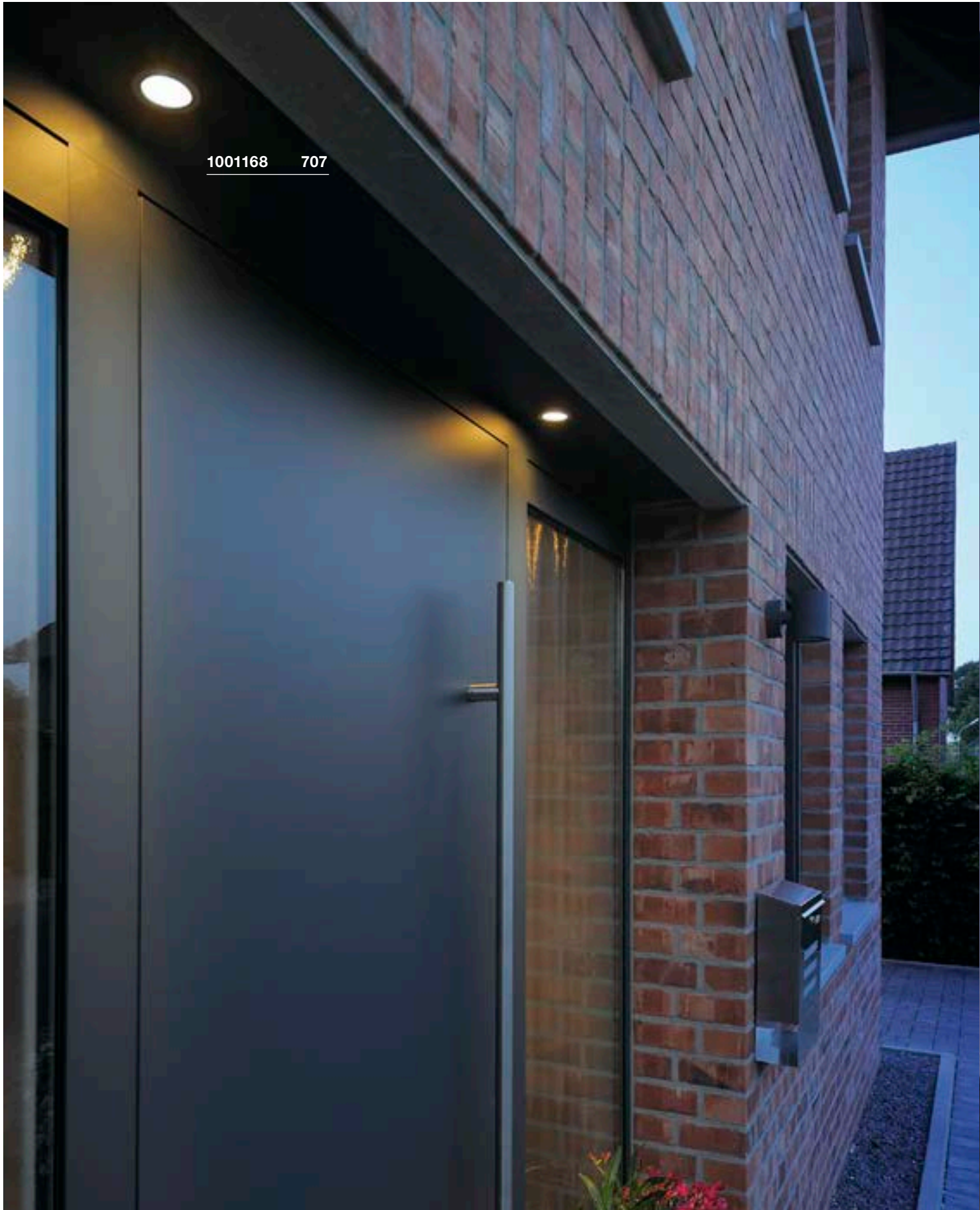

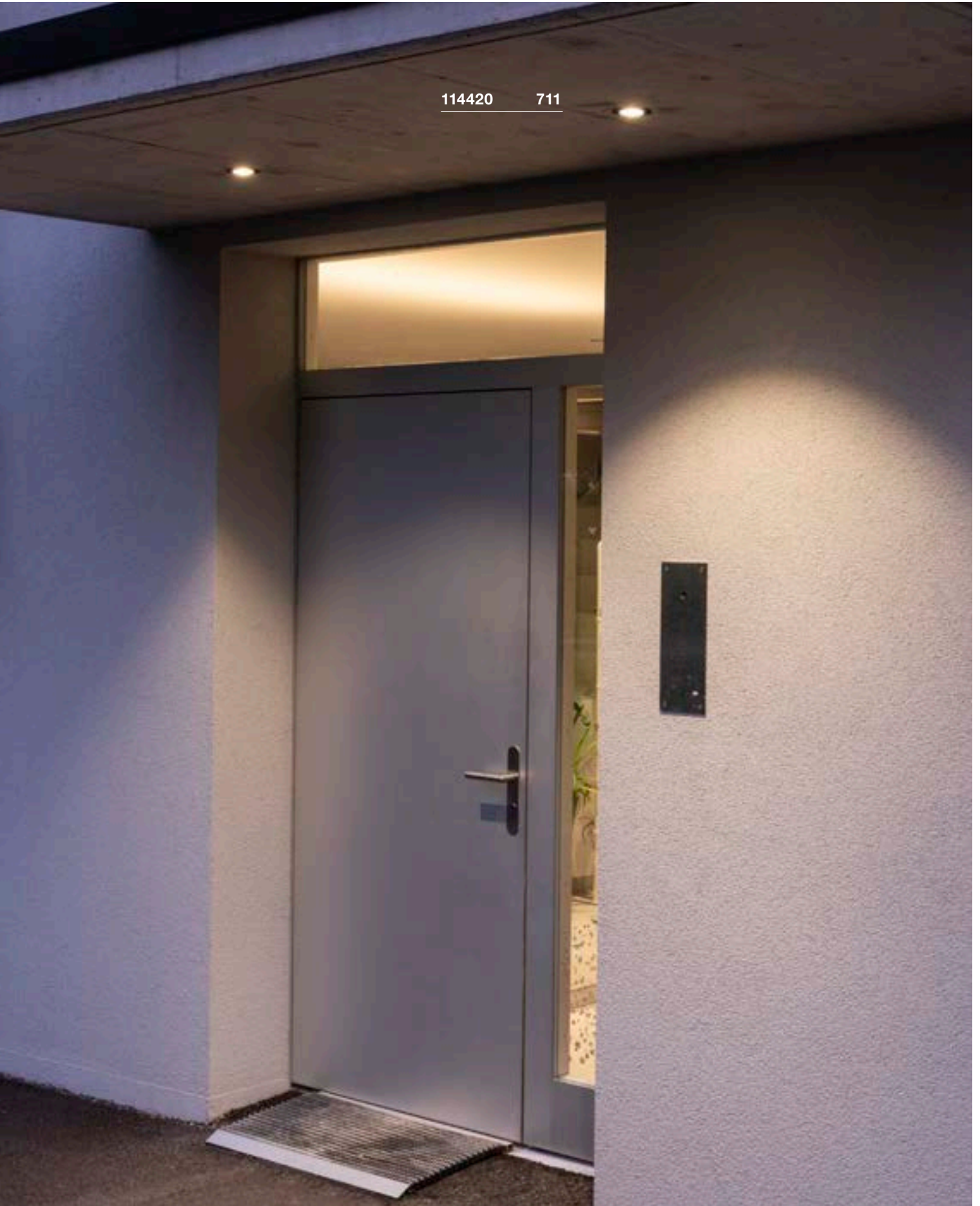

114420 711

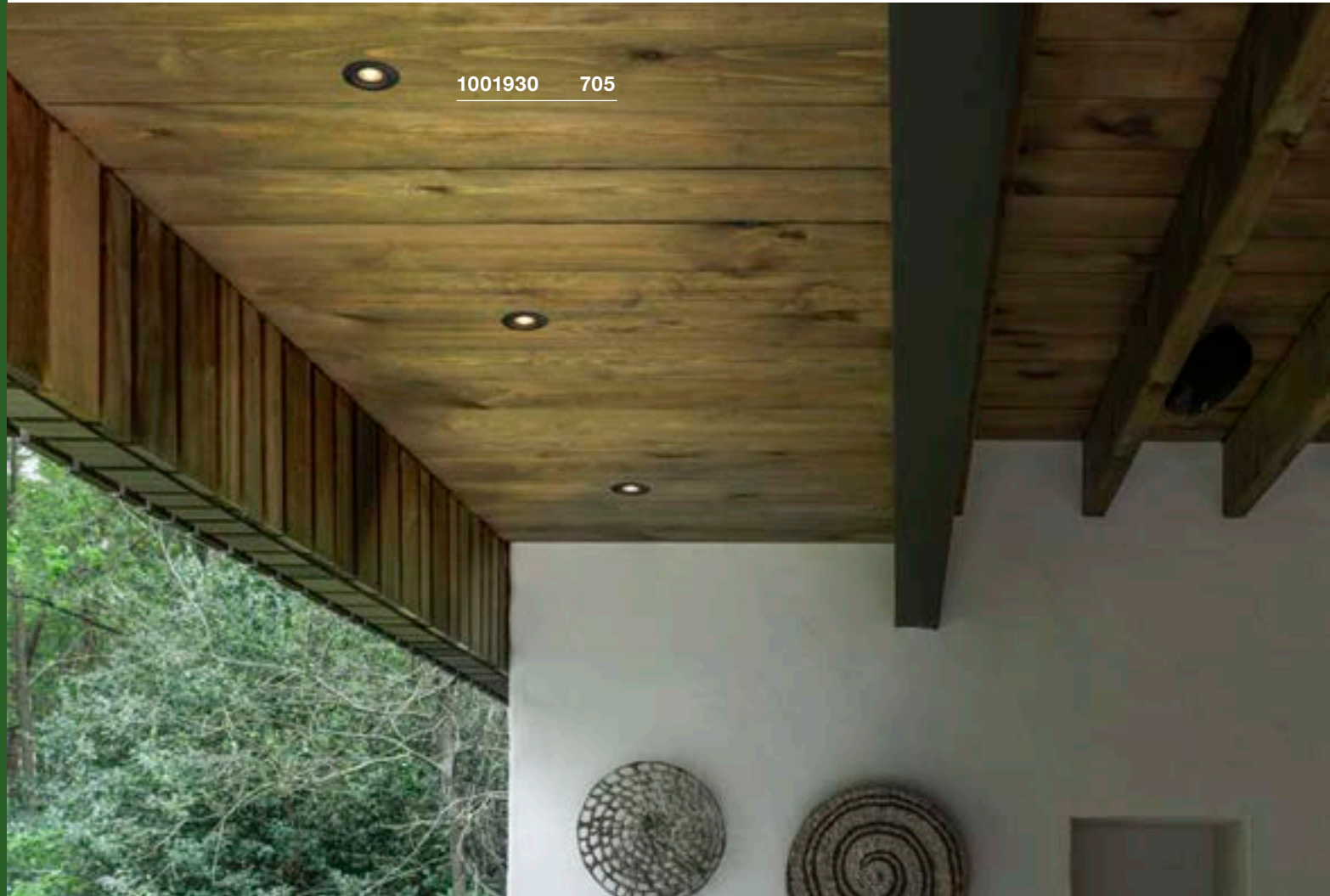
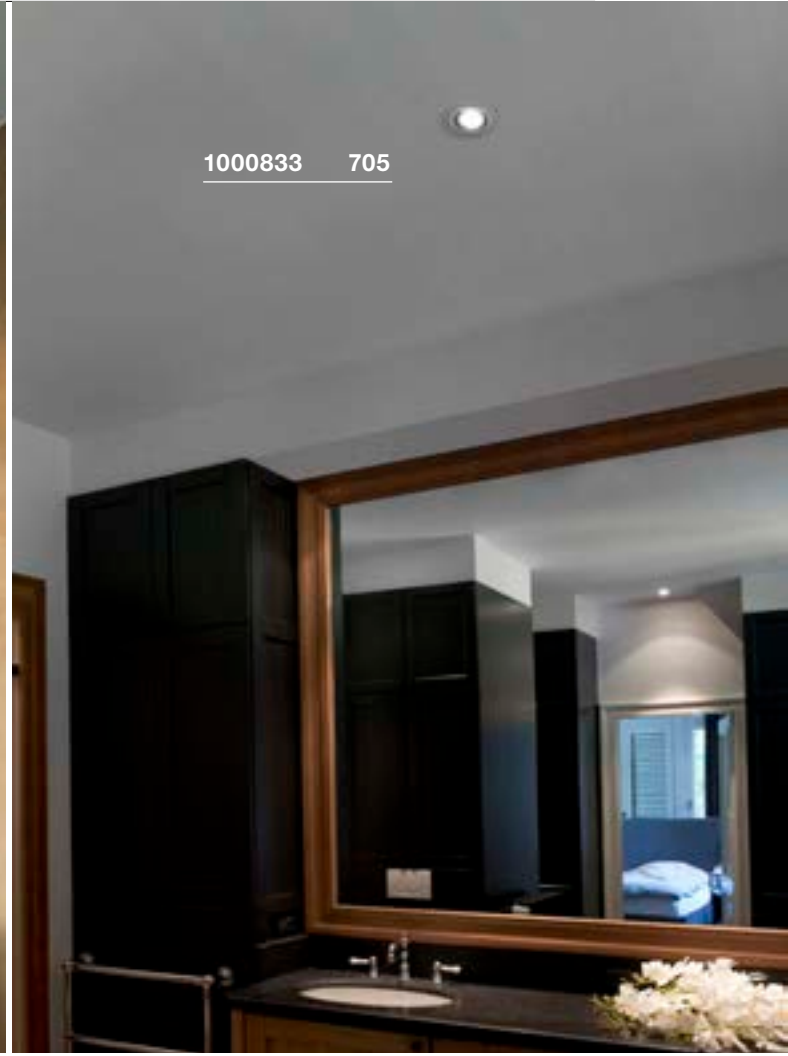

VARU
EL, QPAR51



- Hohe IP Schutzart
- Widerstandsfähiges Gehäuse

Produktangaben

230V~50Hz
Material: Aluminium / Glas

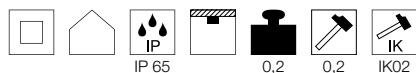

Maßzeichnung

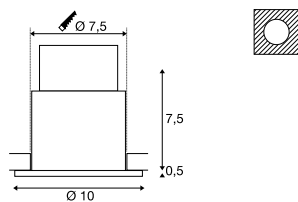

Hinweis

Materialstärke Einbaufäche: 15 m

Leuchtmittellempfehlung

GU10 5,5W 36°
2800K 420lm EEK=A+
6kWh/1000h
Art. Nr. 1001217



LED GU10 7,2W 36°
2700K 520lm EEK=A+
8kWh/1000h
Art. Nr. 1001560



Leuchtmittelangaben

max. 5W LED GU10 51mm
Ø: 5 cm max. L: 4,6 cm max.

Variante	Art. Nr.
GU10 LED GU10 51mm ■ schwarz	1001930
GU10 LED GU10 51mm □ weiß	1001931

VARU
EL

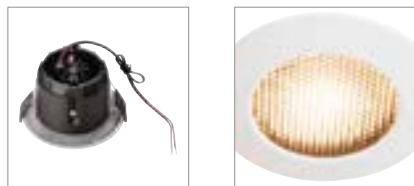

- Hohe IP Schutzart
- Widerstandsfähiges Gehäuse
- Blendreduzierung durch rückversetzte LED

Produktangaben

350mA | 5W
Material: Aluminium / Glas

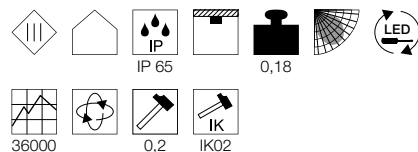

Maßzeichnung

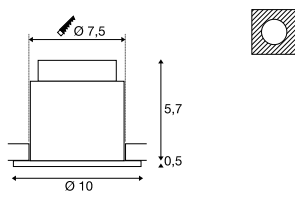

Hinweis

Materialstärke Einbaufäche: 15 m

Zubehöreffpehlung

- LED Treiber 350mA | 9W
Art. Nr. 464109
- Wabenfil er
Art. Nr. 1001934



Variante	Art. Nr.
400lm 2700K CRI>80 ■ schwarz	1001932
400lm 2700K CRI>80 □ weiß	1001933

KINI
EL, TRIAC



- Feuchtraum geeignet
- Schwenkbar

Produktangaben

220-240V ~50/60Hz | 260mA
Systemleistung: 12W
Material: Aluminium / Polycarbonat (PC)
Dimmbar: Triac C, Triac L

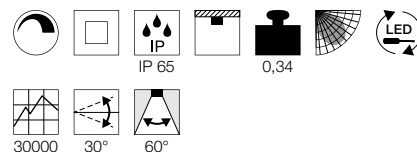

Maßzeichnung

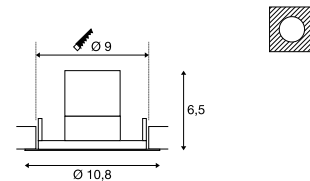

Hinweis

Materialstärke Einbaufäche: 5-20 m

Variante	Art. Nr.
850lm 3000K CRI>80 □ weiß	1000833

DOLIX OUT
EL, round, QR-C51

C-A+ Spektrum
A++-E



DOLIX OUT
EL, square, QR-C51

C-A+ Spektrum
A++-E



Produktangaben

12V ~50Hz
Material: Aluminium / Glas

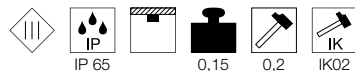

Maßzeichnung

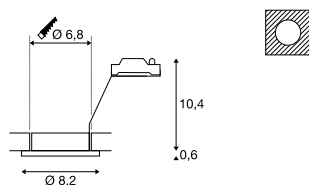

Hinweis

Materialstärke Einbaufäche: 20 m

Produktangaben

12V ~50Hz
Material: Aluminium / Glas



Maßzeichnung

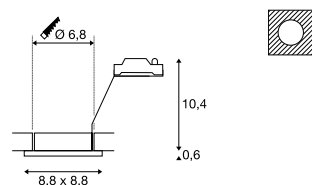

Hinweis

Materialstärke Einbaufäche: 20 m

Leuchtmittlempfehlung

LED GU5.3 5,5W 36°
2700K 450lm EEK=A+
7kWh/1000h
Art. Nr. 1001574



Leuchtmittelangaben

max. 50W QR-C51

Variante	Art. Nr.
GX5.3 QR-C51	
<input type="checkbox"/> weiß	1001157

Leuchtmittlempfehlung

LED GU5.3 5,5W 36°
2700K 450lm EEK=A+
7kWh/1000h
Art. Nr. 1001574



Leuchtmittelangaben

max. 50W QR-C51

Variante	Art. Nr.
GX5.3 QR-C51	
<input type="checkbox"/> weiß	1001161

1001157 706





1001167 707

DOLIX OUT
EL, round, QPAR51

E-A++ Spektrum A++-E



Produktangaben

220-240V ~50/60Hz
Material: Aluminium / Glas

Maßzeichnung

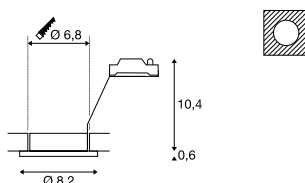

Hinweis

Materialstärke Einbaufäche: 20 mm

Leuchtmittlempfehlung

LED GU10 5,5W 38°
2700K 400lm EEK=A+
6kWh/1000h

Art. Nr. 1001030



LED GU10 7,2W 36°
3000K 520lm EEK=A+
8kWh/1000h

Art. Nr. 1001562



Leuchtmittelangaben

max. 50W QPAR51

Variante	Art. Nr.
GU10 QPAR51	
weiß	1001165
GU10 QPAR51	
chrom	1001166
GU10 QPAR51	
grau / transparent	1001167
GU10 QPAR51	
chrom	1001168

DOLIX OUT
EL, square, QPAR51

E-A++ Spektrum A++-E



Produktangaben

220-240V ~50/60Hz
Material: Aluminium / Glas

Maßzeichnung

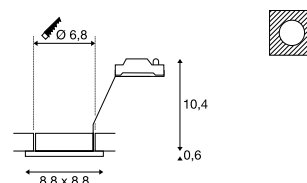

Hinweis

Materialstärke Einbaufäche: 20 mm

Leuchtmittlempfehlung

LED GU10 5,5W 38°
2700K 400lm EEK=A+
6kWh/1000h

Art. Nr. 1001030



LED GU10 7,2W 36°
3000K 520lm EEK=A+
8kWh/1000h

Art. Nr. 1001562



Leuchtmittelangaben

max. 50W QPAR51

Variante	Art. Nr.
GU10 QPAR51	
weiß	1001169
GU10 QPAR51	
chrom	1001170
GU10 QPAR51	
grau / transparent	1001171
GU10 QPAR51	
chrom	1001172

OUT 65
EL, round, TRIAC

A-A++ Spektrum A++-E

INSIDE



• Hohe IP-Schutzart

OUT 65
EL, square, TRIAC

A-A++ Spektrum A++-E

INSIDE



• Hohe IP-Schutzart

Produktangaben

220-240V ~50/60Hz | 500mA
Systemleistung: 11W
Material: Aluminium / Glas
Dimmbar: Triac C, Triac L

40000 38°

Produktangaben

220-240V ~50/60Hz | 500mA
Systemleistung: 11W
Material: Aluminium / Glas
Dimmbar: Triac C, Triac L

40000 38°

Maßzeichnung

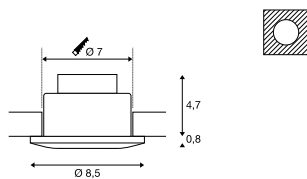

Maßzeichnung

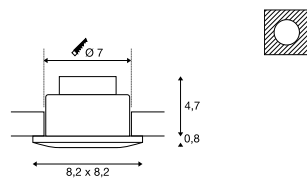

Hinweis

Materialstärke Einbaufäche: 20 m

Hinweis

Materialstärke Einbaufäche: 20 m

Variante	Art. Nr.
510lm 3000K CRI>80	
■ schwarz	114460
640lm 3000K CRI>80	
□ weiß	114461

Variante	Art. Nr.
510lm 3000K CRI>80	
■ schwarz	114470
640lm 3000K CRI>80	
□ weiß	114471

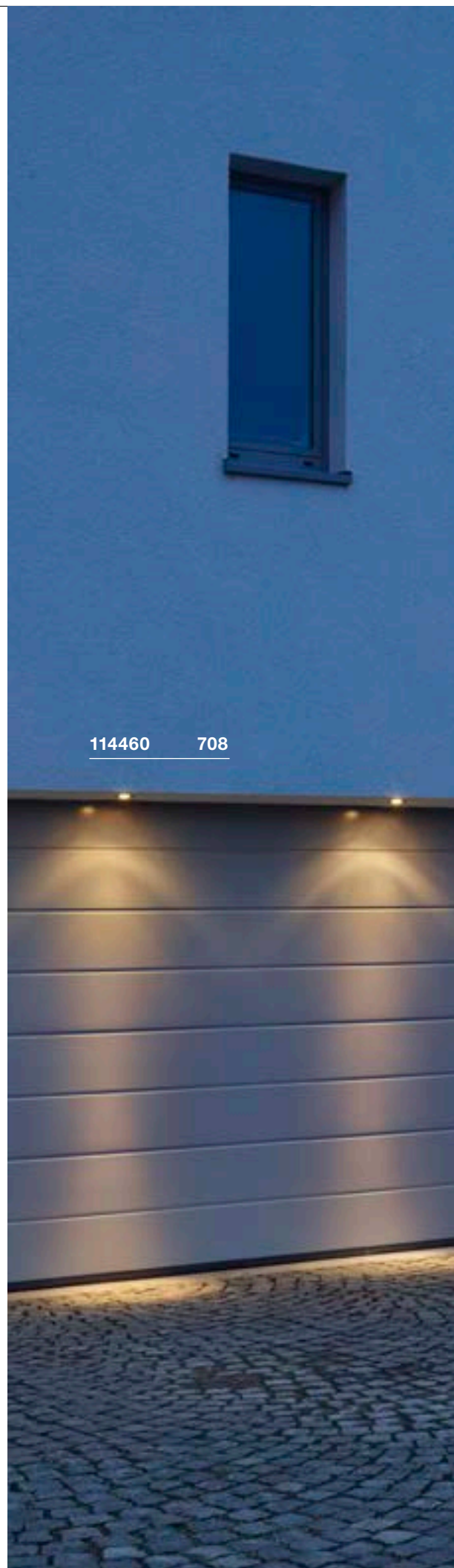

114460

708

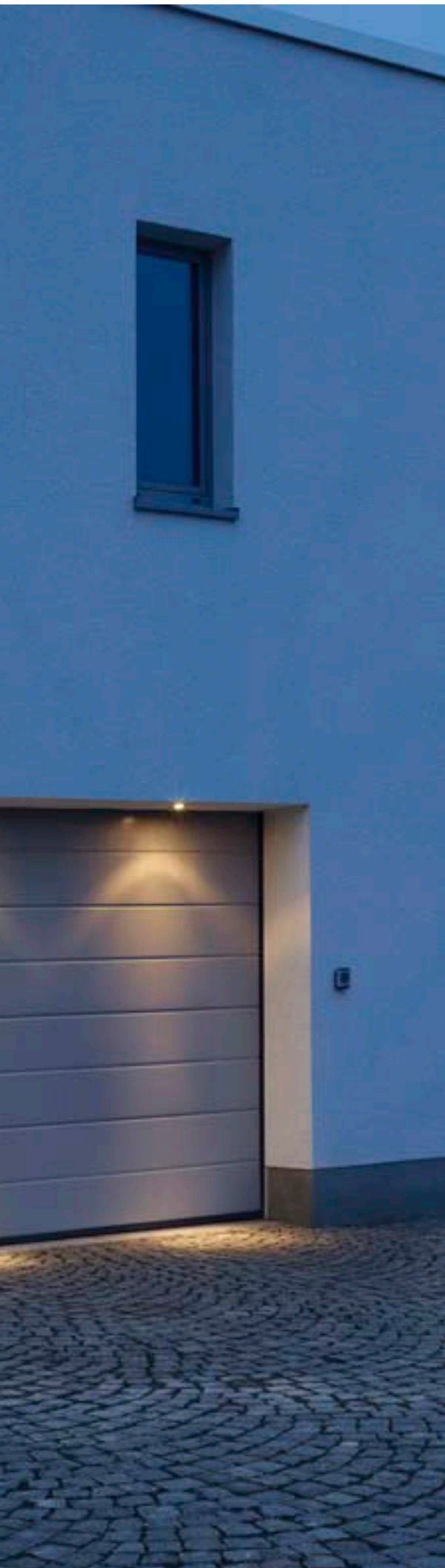

PATTA-F
EL, round, TRIAC

A-A++ Spektrum A++-E

LED INSIDE



• Hohe IP-Schutzart

Produktangaben

220-240V ~50/60Hz | 500mA
Systemleistung: 11W
Material: Aluminium / Glas
Dimmbar: Triac C, Triac L

IP 65 0,3

40000 38°

Maßzeichnung

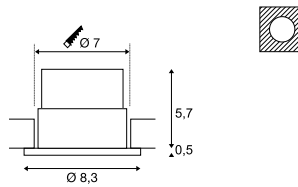

Hinweis

Materialstärke Einbaufäche: 20 m

PATTA-F
EL, square, TRIAC

A-A++ Spektrum A++-E

LED INSIDE

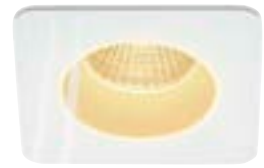

• Hohe IP-Schutzart

Produktangaben

220-240V ~50/60Hz | 500mA
Systemleistung: 11W
Material: Aluminium / Glas
Dimmbar: Triac C, Triac L

IP 65 0,32

40000 38°

Maßzeichnung

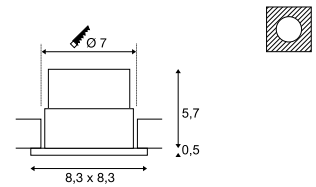

Hinweis

Materialstärke Einbaufäche: 20 m

Variante	Art. Nr.
745lm 3000K CRI>80	
■ schwarz	114440
860lm 3000K CRI>80	
□ weiß	114441

Variante	Art. Nr.
745lm 3000K CRI>80	
■ schwarz	114450
860lm 3000K CRI>80	
□ weiß	114451

PATTA-I
EL, round, TRIAC



- Premium LED mit CRI>90
- Dim to Warm (1800-3000K)
- Hohe IP-Schutzart

Produktangaben

220-240V ~50/60Hz | 350mA
Systemleistung: 7,3W
Material: Aluminium / Glas
Dimmbar: Triac C, Triac L

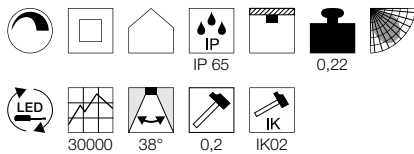

Maßzeichnung

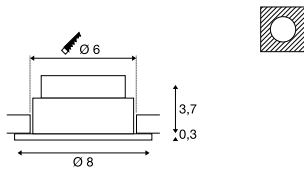

Hinweis

Produkte werden mit Clipfedern geliefert. Blattfedern liegen dem Produkt bei und können ausgetauscht werden. Materialstärke Einbaulfläche: 20 m

PATTA-I
EL, square, TRIAC



- Premium LED mit CRI>90
- Dim to Warm (1800-3000K)
- Hohe IP-Schutzart

Produktangaben

220-240V ~50/60Hz | 350mA
Systemleistung: 7,3W
Material: Aluminium / Glas
Dimmbar: Triac C, Triac L

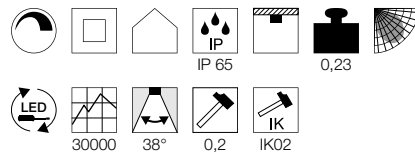

Maßzeichnung

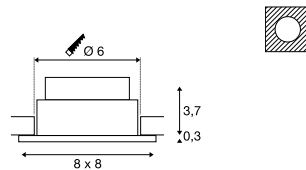

Hinweis

Produkte werden mit Clipfedern geliefert. Blattfedern liegen dem Produkt bei und können ausgetauscht werden. Materialstärke Einbaulfläche: 20 m

Variante	Art. Nr.
440lm 1800-3000K CRI>95 ■ schwarz	1002098
440lm 1800-3000K CRI>95 □ matt weiß	1002099
440lm 1800-3000K CRI>95 ■ matt aluminium	1002100

Variante	Art. Nr.
440lm 1800-3000K CRI95 ■ schwarz	1002101
440lm 1800-3000K CRI95 □ matt weiß	1002102
440lm 1800-3000K CRI95 ■ matt aluminium	1002103



PATTA-I
EL, round, TRIAC

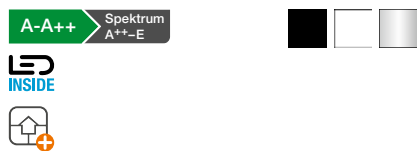

- Hohe IP-Schutzart

Produktangaben

220-240V ~50/60Hz | 500mA
Systemleistung: 11W
Material: Aluminium / Glas
Dimmbar: Triac C, Triac L

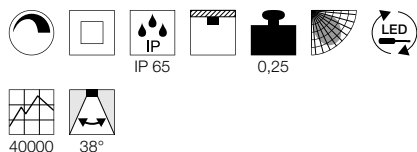

Maßzeichnung

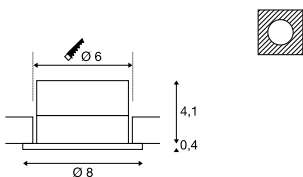

Hinweis

Materialstärke Einbaufäche: 25 m

Variante	Art. Nr.
910lm 3000K CRI>80 ■ matt schwarz	114420
910lm 3000K CRI>80 □ matt weiß	114421
910lm 3000K CRI>80 ■ matt aluminium	114426

PATTA-I
EL, square, TRIAC

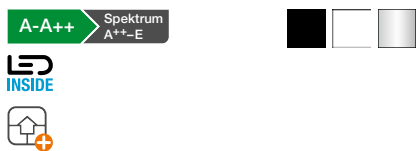

- Hohe IP-Schutzart

Produktangaben

220-240V ~50/60Hz | 500mA
Systemleistung: 11W
Material: Aluminium / Glas
Dimmbar: Triac C, Triac L

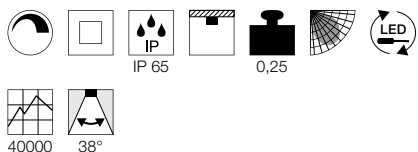

Maßzeichnung

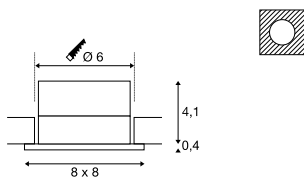

Hinweis

Materialstärke Einbaufäche: 25 m

Variante	Art. Nr.
910lm 3000K CRI>80 ■ matt schwarz	114430
910lm 3000K CRI>80 □ matt weiß	114431
910lm 3000K CRI>80 ■ matt aluminium	114436

KAMUELA ECO
EL, round, TRIAC



- Feuerbeständig für mind. 90 Minuten nach BS 476-21
- IP 65 Leuchte mit effizienter LED-Technologie

Produktangaben

220-240V ~50Hz
Systemleistung: 6,5W
Material: Aluminium / Kunststoff
Dimmbar: Triac C, Triac L

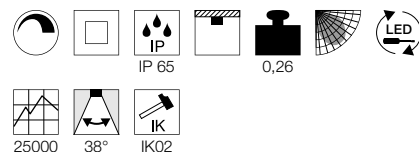

Maßzeichnung

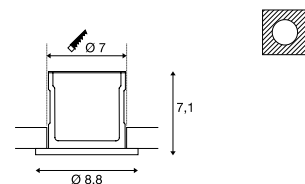

Hinweis

Materialstärke Einbaufäche: 40 mm max

Variante	Art. Nr.
400lm 3000K CRI>80 ■ schwarz	1001015
400lm 3000K CRI>80 □ weiß	1001016
400lm 4000K CRI>80 ■ schwarz	1001017
400lm 4000K CRI>80 □ weiß	1001018

BODENEINBAULEUCHTEN

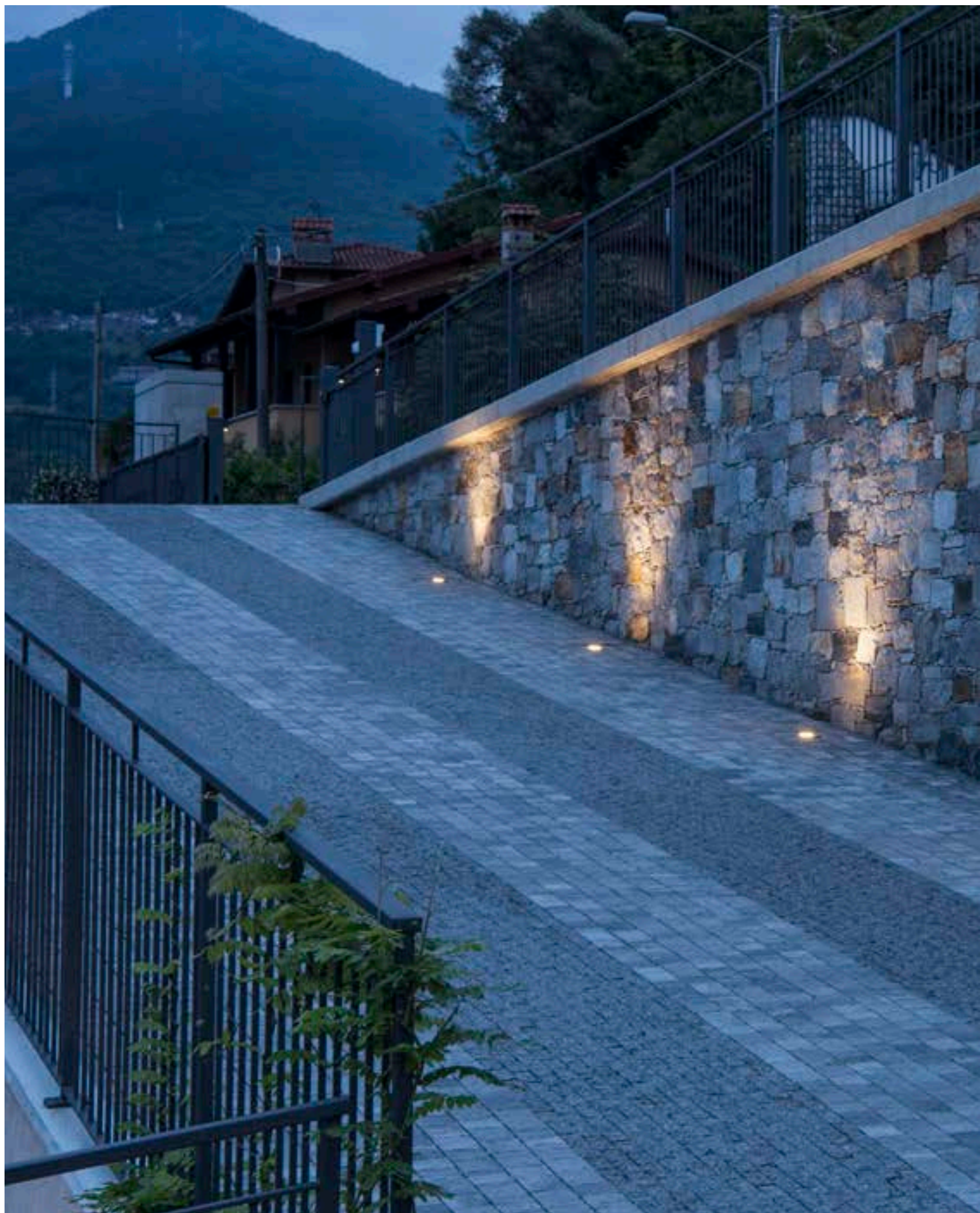

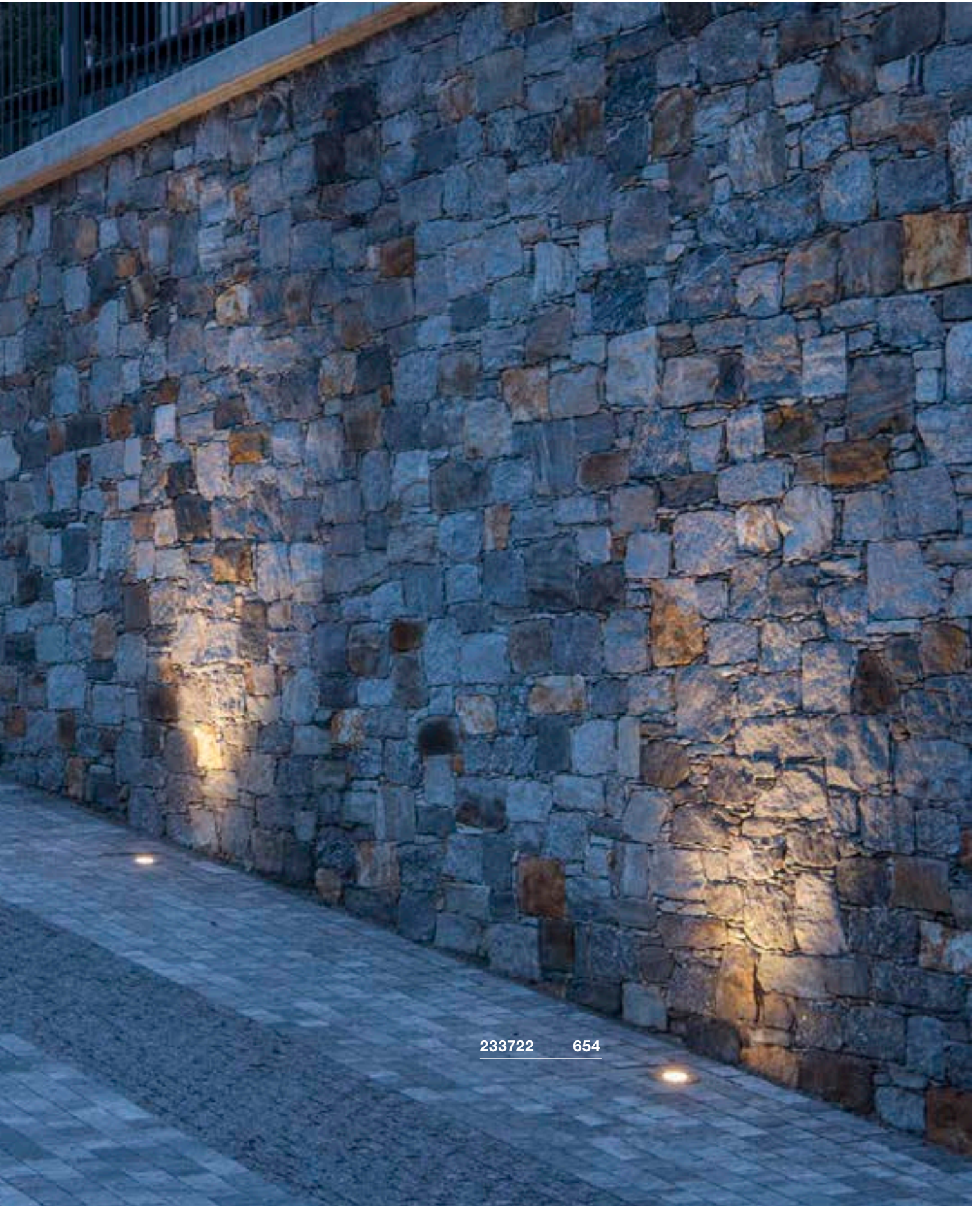

233722

654

BIG PLOT Module

A-A++ Spektrum
A++-E

LED
INSIDE



- Edelstahl 316
- Besonders hohe IP-Schutzart
- Unterschiedliche Lichtwirkung mit Hilfe von geeigneten Abdeckungen realisierbar

Produktangaben

220-240V ~50/60Hz | 16mA
Systemleistung: 5,5W
Material: Edelstahl316L/PMMA



Maßzeichnung

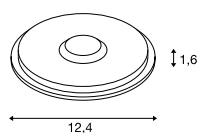

Hinweis

Offenes Kabelend
Produkt wird ohne Cover geliefert.
Passende Cover finden Sie auf Sei e 715.

Zubehörempfehlung

■ Verbindungsbox IP68, 3-polig
Art. Nr. **228730**



Variante	Art. Nr.
460lm 3000K CRI>80 ■ edelstahl	1001359

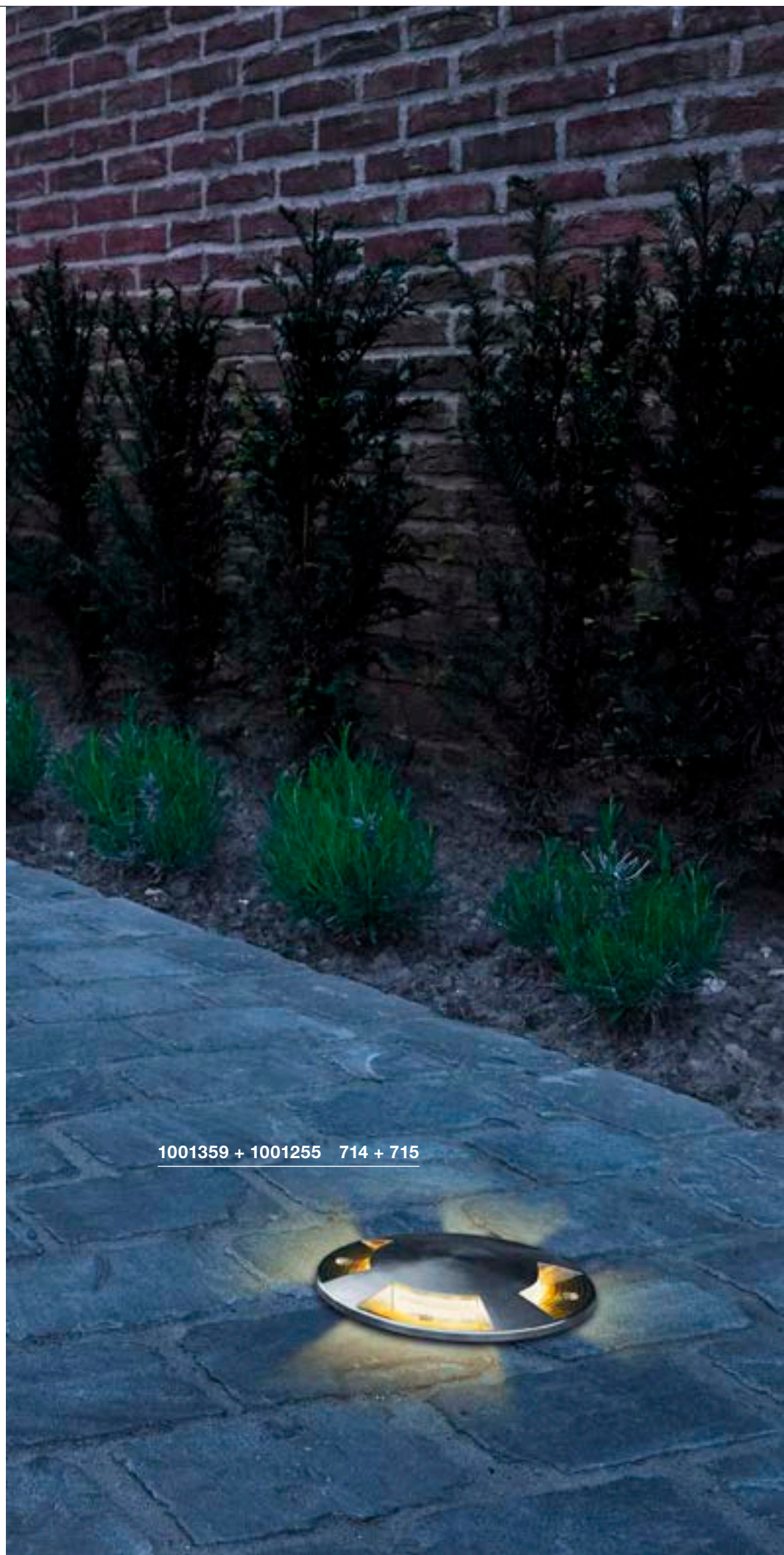

1001359 + 1001255 714 + 715

BIG PLOT
Module



- Besonders hohe IP-Schutzart
- Unterschiedliche Lichtwirkung mit Hilfe von geeigneten Abdeckungen realisierbar

Produktangaben

220-240V ~50/60Hz | 16mA
Systemleistung: 5,5W
Material: Aluminium/ PMMA



Maßzeichnung

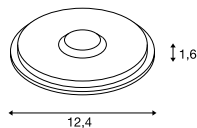

Hinweis

Offenes Kabelend
Produkt wird ohne Cover geliefert.
Passende Cover finden Sie auf Seite 715.

Zubehörempfehlung

■ Verbindungsbox IP68, 3-polig
Art. Nr. 228730

Variante	Art. Nr.
460lm 3000K CRI>80	
■ silbergrau	1001256

BIG PLOT
Cover, 2 slots

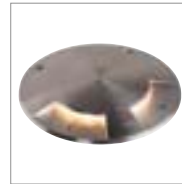
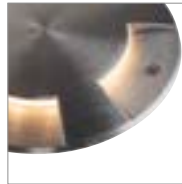

Produktangaben

Material 1001254: Edelstahl316
Material 1001252/1001262: Aluminium



Maßzeichnung

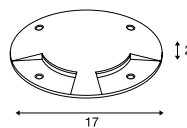

BIG PLOT
Cover, 4 slots

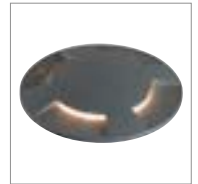

Produktangaben

Material 1001255: Edelstahl316
Material 1001253/1001263: Aluminium



Maßzeichnung

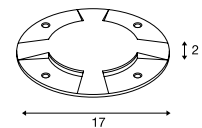

Variante	Art. Nr.
0,91 kg 0,8 t	
■ edelstahl	1001254
0,34 kg 0,5 t	
■ silbergrau	1001252
0,34 kg 0,5 t	
■ anthrazit	1001262

Variante	Art. Nr.
0,85 kg 0,8 t	
■ edelstahl	1001255
0,33 kg 0,5 t	
■ silbergrau	1001253
0,33 kg 0,5 t	
■ anthrazit	1001263

TRAIL-LITE® 60 EL

A-A++ Spektrum
A++-E

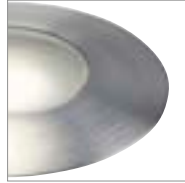

• Blende: Edelstahl 316

Produktangaben

12V/0,3W
Material: Edelstahl316/Glas



IP 65

0,15

20000

28

Maßzeichnung

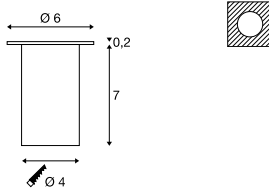

228332 717

Hinweis

Betrieb nur mit konventionellem Trafo.
Einbautopf inkl.
Die Leuchte ist für den Einbau in Holz geeignet

Zubehörempfehlung

■ Transformator 12V AC | 10VA IP44
Art. Nr. 227140



Variante	Art. Nr.
10lm 6500K CRI>80 edelstahl gebürstet	227461
10lm 3000K CRI>80 edelstahl gebürstet	227462



227462 716



227461 716

POWER TRAIL-LITE®
EL, round

A-A++ Spektrum A++-E



- Blende: Edelstahl 316
- Premium LED

Produktangaben

350mA | 1,4W
Material: Edelstahl316/Glas

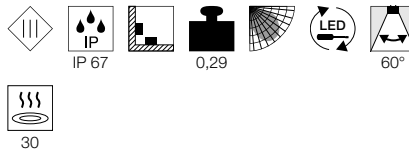

Maßzeichnung

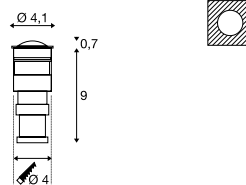

Hinweis

Betrieb nur mit Treiber 350mA. Verdrahtung von mehreren PowerLEDs nur in Reihenschaltung!
Einbauhülse inkl.
Die Leuchte ist für den Einbau in Holz geeignet.

Zubehörempfehlung

- LED Treiber 350mA | 3W inkl. Zugentlastung
Art. Nr. 464108
- LED Treiber 350mA | 9W
Art. Nr. 464109



Variante	Art. Nr.
45lm 3000K CRI>90 ■ edelstahl	228332
48lm 4000K CRI>90 ■ edelstahl	1002189

POWER TRAIL-LITE®
EL, square

A-A++ Spektrum A++-E

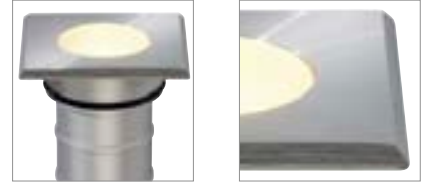

Produktangaben

350mA | 1,4W
Material: Edelstahl316/Glas

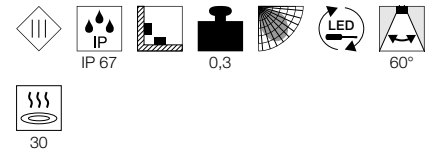

Maßzeichnung

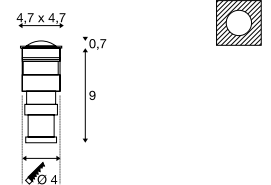

Hinweis

Betrieb nur mit Treiber 350mA. Verdrahtung von mehreren PowerLEDs nur in Reihenschaltung!
Einbauhülse inkl.
Die Leuchte ist für den Einbau in Holz geeignet.

Zubehörempfehlung

- LED Treiber 350mA | 3W inkl. Zugentlastung
Art. Nr. 464108
- Anschlussbox
Art. Nr. 229260



Variante	Art. Nr.
45lm 3000K CRI>90 ■ edelstahl	228342

SOLASTO

EL, square/round

A-A++ Spektrum
A++-E



• Blende: Edelstahl 316

Produktangaben

230V ~50Hz

Material: Kunststoff/Edelstahl304/Gla



Maßzeichnung

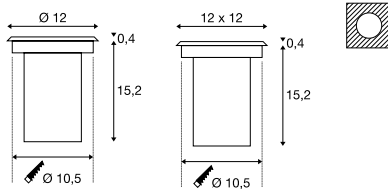

Hinweis

Einbautopf inkl.

Leuchtmittelempfehlung

GU10 5,5W 36°
2800K 420lm EEK=A+
6kWh/1000h
Art. Nr. 1001217



LED GU10 5,5W 38°
2700K 400lm EEK=A+
6kWh/1000h | 3 Step-Dim
Art. Nr. 1001030



Leuchtmittelangaben

6W max.

Variante	Art. Nr.
GU10 LED GU10 51mm edelstahl	227680
GU10 LED GU10 51mm edelstahl	227684

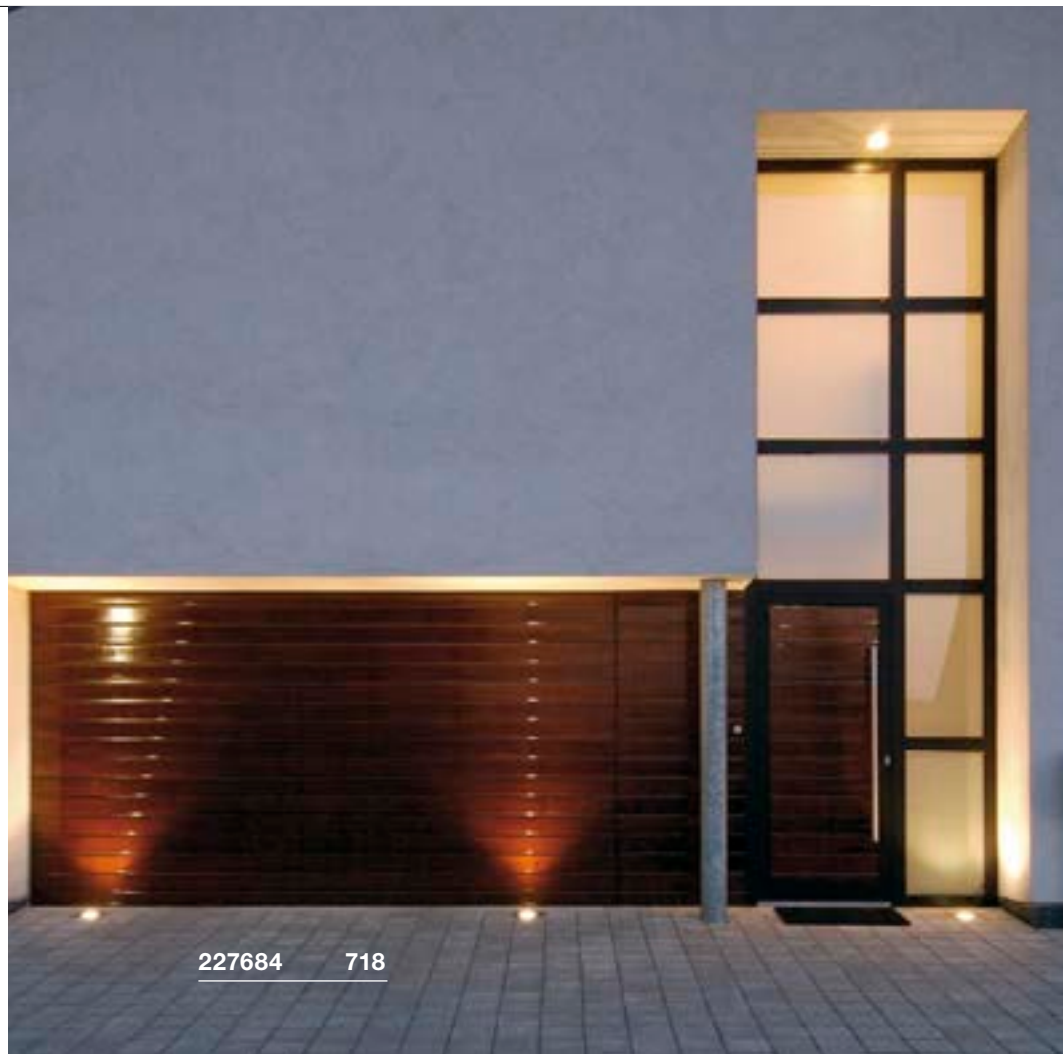

227684 718

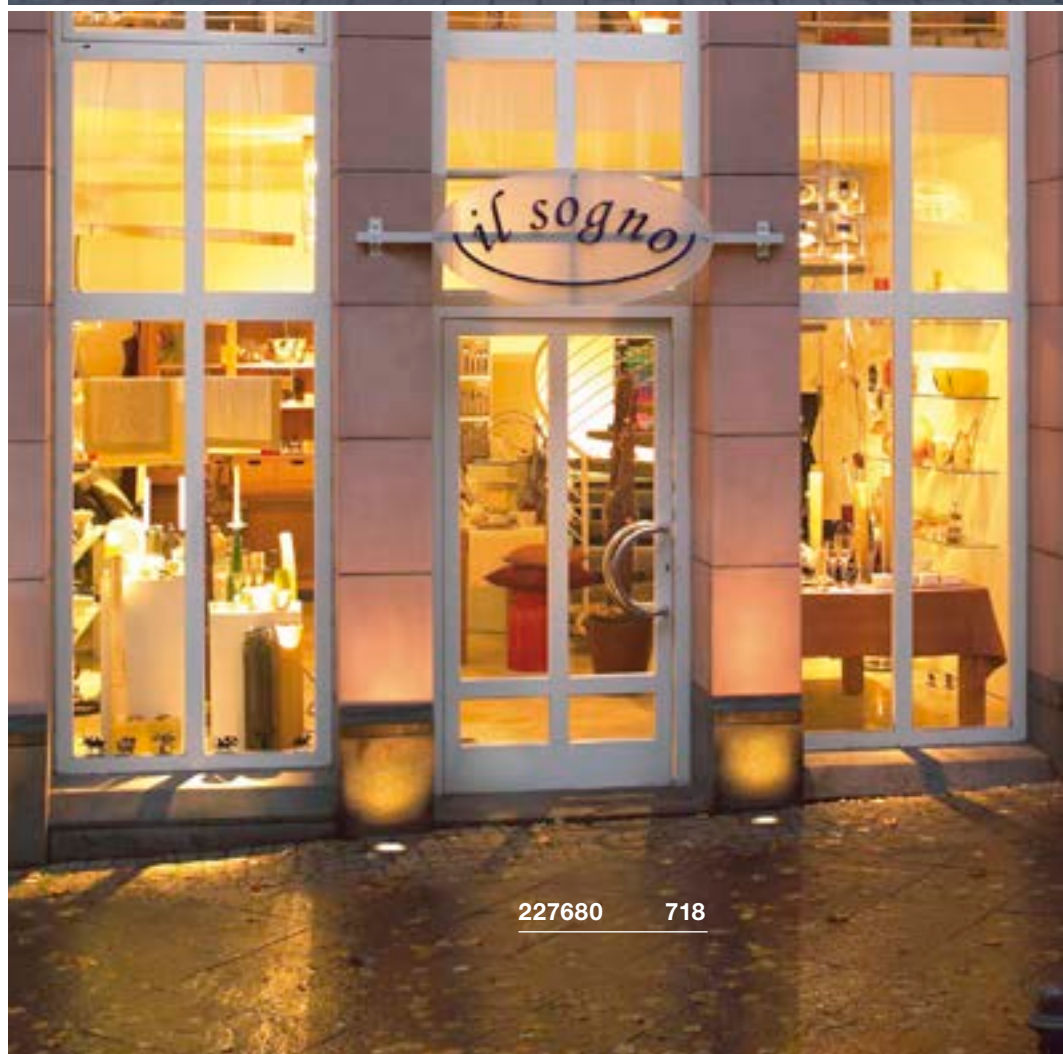

227680 718

WETSY
EL, square/round

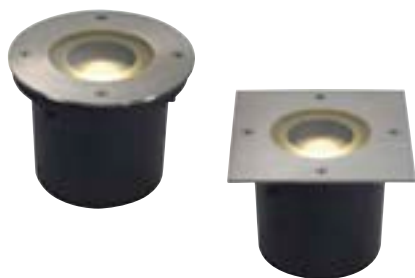

- Blende: Edelstahl 316

Produktangaben

220-240V ~50/60Hz
Systemleistung: 6,3W
Material: Edelstahl316/Aluminium/Glas

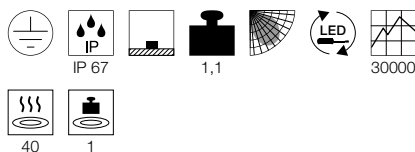

Maßzeichnung

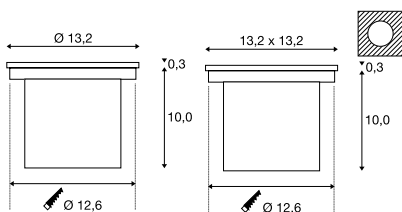

Hinweis

Einbautopf inkl.

Zubehörempfehlung

■ Verbindungsbox IP68, 3-polig
Art. Nr. 228730

Variante	Art. Nr.
300lm 3000K CRI>80 ● ■ edelstahl	230170
300lm 3000K CRI>80 □ ■ edelstahl	230174

ROCCI
EL, round



- Blende: Edelstahl 316
- Premium LED

Produktangaben

200-240V ~50/60Hz 700mA
Systemleistung: 9,8W
Material: Edelstahl316/Aluminium/Glas

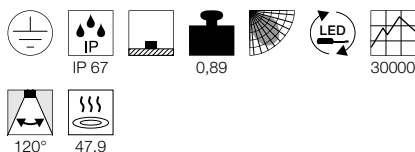

Maßzeichnung

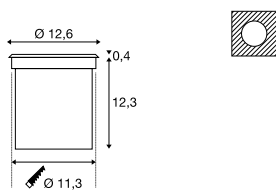

Hinweis

Einbautopf inkl.

Variante	Art. Nr.
580lm 3000K CRI>80 ■ edelstahl	227600
630lm 4000K CRI>80 ■ edelstahl	1002185

ROCCI
EL, square



- Blende: Edelstahl 316
- Premium LED

Produktangaben

200-240V ~50/60Hz 700mA
Systemleistung: 9,8W
Material: Edelstahl316/Aluminium/Glas

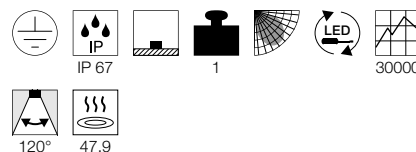

Maßzeichnung

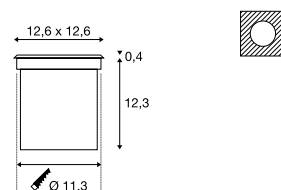

Hinweis

Einbautopf inkl.

Variante	Art. Nr.
580lm 3000K CRI>80 ■ edelstahl	227604
630lm 4000K CRI>80 ■ edelstahl	1002186

GIMBLE OUT EL

A-A++ Spektrum
A++-E

LED
INSIDE



- Gehäuse und Blende: Edelstahl 316L
- Premium LED

Produktangaben

220-240V ~50/60Hz 600mA
Systemleistung: 13W
Material: Edelstahl 316L/Glas

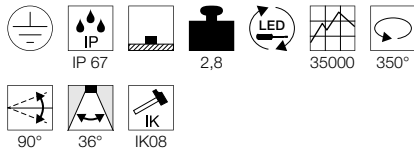

Maßzeichnung

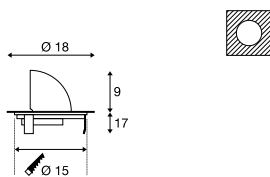

Hinweis

Offenes Kabelend

Zubehörempfehlung

Einbaurohr DN160

Art. Nr. 233792

Verbindungsbox IP68, 3-polig

Art. Nr. 228730

Bodeneinbautopf

Art. Nr. 1000655

DN160 Montagefeder
für ein Holzbau

Art. Nr. 233797

Variante

Art. Nr.

1000lm | 3000K | CRI>80

edelstahl gebürstet

1000384



1000834 720



ADJUST 135
EL, square/round, QPAR51

E-A++ Spektrum A++-E



- Blende: Edelstahl 304

Produktangaben

230V ~50Hz
Material: Kunststoff

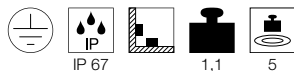

Maßzeichnung

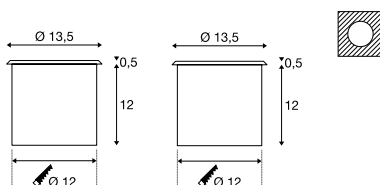

Hinweis

Einbautopf inkl.

Leuchtmittlempfehlung

LED GU10 7,2W 36°
4000K 590lm EEK=A+
8kWh/1000h

Art. Nr. 1001565



LED GU10 7,2W 36°
2700K 570lm EEK=A+
8kWh/1000h

Art. Nr. 1001560



Leuchtmittelangaben

35W max.
Ø: 5 cm max. L: 5,7 cm max.
optional: LED

Variante	Art. Nr.
GU10 QPAR51 edelstahl	228210
GU10 QPAR51 edelstahl	228214

ADJUST 190
EL, square/round, QR111

D-A+ Spektrum A++-E



- Blende: Edelstahl 304
- Schwenkbar

Produktangaben

230V ~50Hz 12V AC
Material: Edelstahl304/Aluminium/Glas



Maßzeichnung

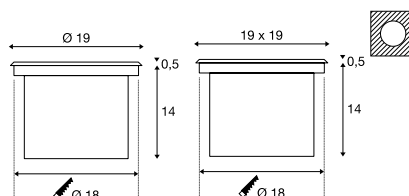

Hinweis

Einbautopf inkl.

Leuchtmittlempfehlung

G53 9W 13°
4000K 720lm EEK=A+
10kWh/1000h

Art. Nr. 560624



LED G53 15W 24°
3000K 770lm EEK=A
17kWh/1000h

Art. Nr. 560233



Leuchtmittelangaben

50W max.
optional: LED

Variante	Art. Nr.
G53 QR111 edelstahl	227090
G53 QR111 edelstahl	227092

ADJUST 265
EL, round, HIT-CE

A-A+ Spektrum A++-E



- Blende: Edelstahl 304

Produktangaben

230V ~50Hz
Material: Edelstahl304/Aluminium/Glas



Maßzeichnung

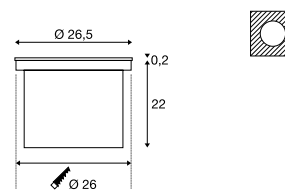

Hinweis

Einbautopf inkl.

Leuchtmittlempfehlung

70W

Variante	Art. Nr.
G12 HIT-CE anthrazit grau RAL7016	228240

DASAR® FLAT 80 EL

A-A++ Spektrum
A++-E



- Blende: Edelstahl 304
- Besonders flache Bauweise

Produktangaben

230V ~50/60Hz
Systemleistung: 4,3W
Material: Edelstahl304/Aluminium/Glas

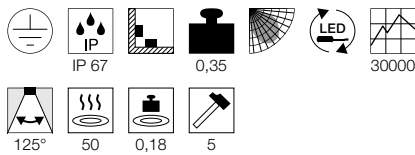

Maßzeichnung

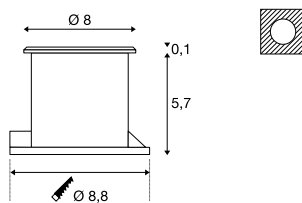

Hinweis

Einbautopf inkl.

Zubehörempfehlung

■ Verbindungsbox IP68, 3-polig
Art. Nr. 228730



Variante	Art. Nr.
140lm 3000K CRI>80 edelstahl gebürstet	228412
150lm 5000K CRI>80 edelstahl gebürstet	228411
140lm 4000K CRI>80 edelstahl gebürstet	1002188

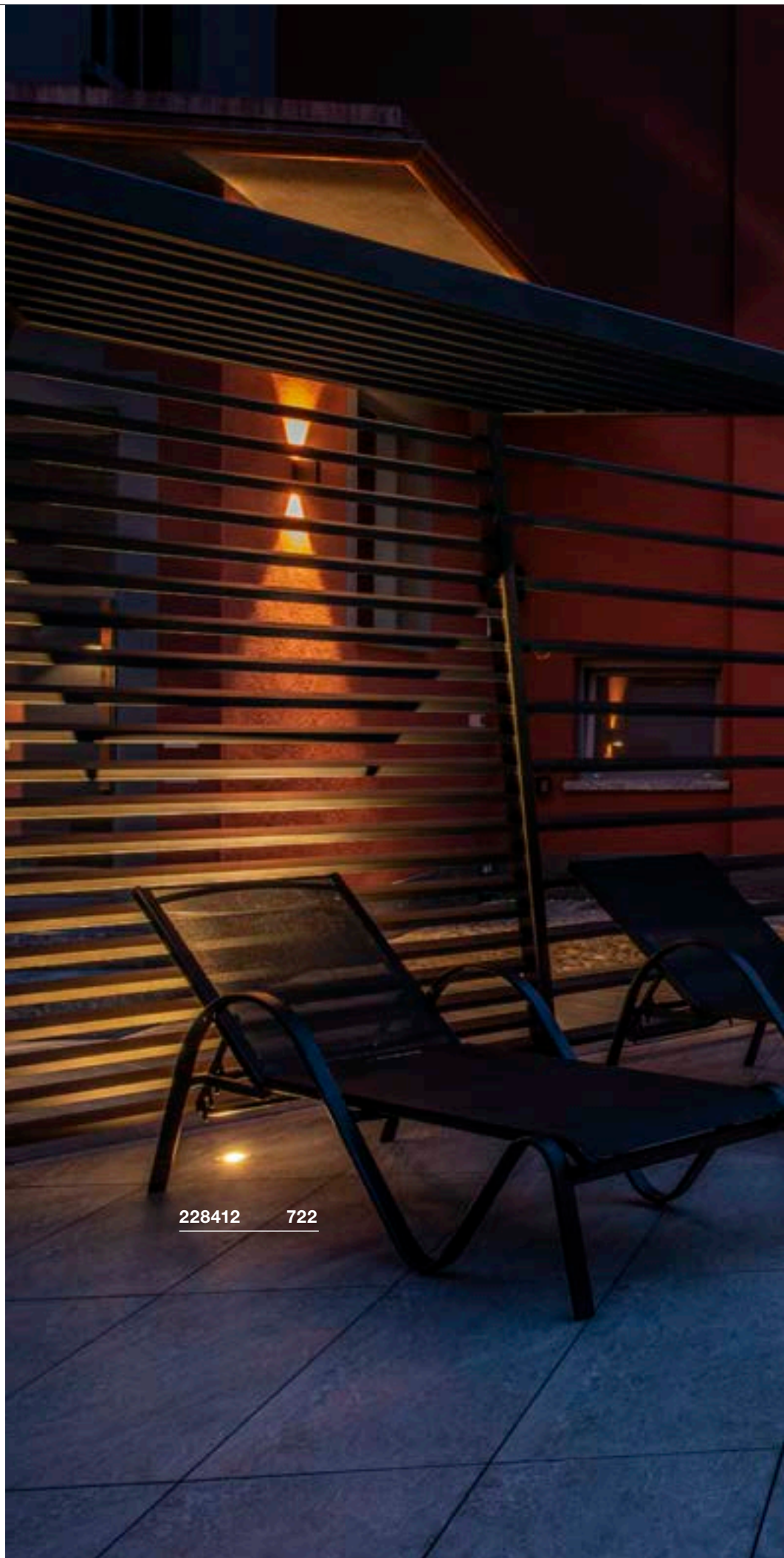

228412 722



233540 723

DASAR® 370
EL, square/round

A-A++ Spektrum
A++-E

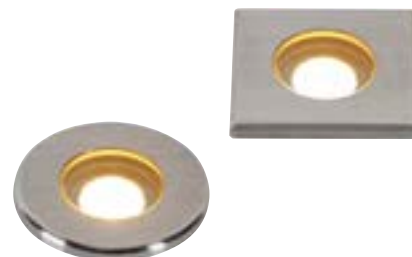

- Gehäuse und Blende: Edelstahl 316L
- Premium LED

Produktangaben

12V/24V DC
Material: Edelstahl316L/Glas

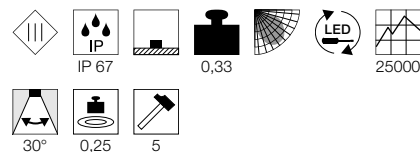

Maßzeichnung

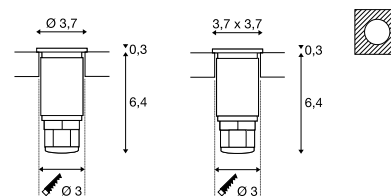

Hinweis

Offenes Kabelend

Zubehörempfehlung

- LED Netzteil 24V DC | 12W
Art. Nr. 470502
- LED Netzteil 12V DC | 12W
Art. Nr. 470507



Variante	Art. Nr.
120lm 3000K CRI>80	
<input checked="" type="checkbox"/> <input type="checkbox"/> edelstahl gebürstet	233540
120lm 3000K CRI>80	
<input type="checkbox"/> <input checked="" type="checkbox"/> edelstahl gebürstet	233550

DASAR® HIGHLIGHTS.

KEINE KOMPROMISSE – EDELSTAHL 316.



DASAR® 920 | 725

Varianten:

- Blende Edelstahl 316
- Gehäuse und Blende Edelstahl 316



DASAR® 100 PREMIUM | 726-727

- rund und eckig
- Blende Edelstahl 316L
- PERLUCOR® Glas:
5 Mal härter und 100 Mal kratzbeständiger als herkömmliches Glas



DASAR® 150 PREMIUM | 727

- rund und eckig
- Blende Edelstahl 316L
- PERLUCOR® Glas:
5 Mal härter und 100 Mal kratzbeständiger als herkömmliches Glas



DASAR® 920 EL

A-A++ Spektrum A++-E



- Blende: Edelstahl 316
- Premium LED

Produktangaben

12V DC / 24V DC | 7W
Material: Edelstahl316/Aluminium/Glas

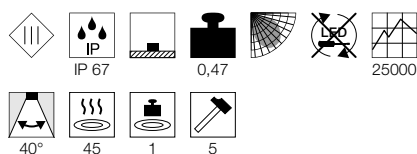

Maßzeichnung

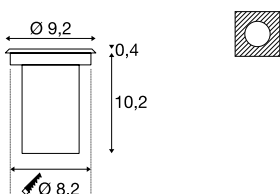

Hinweis

Einbautopf inkl.
Offenes Kabelend

Zubehörempfehlung

LED Netzteil 24V DC | 12W

Art. Nr. 470502

LED Netzteil 12V DC | 12W

Art. Nr. 470507

Variante	Art. Nr.
360lm 3000K CRI>80 ■ edelstahl gebürstet	233500

DASAR® 920 EL

A-A++ Spektrum A++-E



- Blende: Edelstahl 316
- Premium LED

Produktangaben

220-240V ~50/60Hz | 400mA
Systemleistung: 5,5W
Material: Edelstahl316/Aluminium/Glas

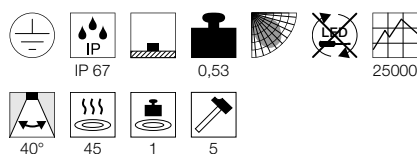

Maßzeichnung

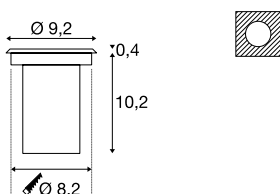

Hinweis

Einbautopf inkl.
Offenes Kabelend

Variante	Art. Nr.
300lm 3000K CRI>80 ■ edelstahl gebürstet	233520

DASAR® 920 EL

A-A++ Spektrum A++-E



- Gehäuse und Blende: Edelstahl 316
- Premium LED

Produktangaben

220-240V ~50/60Hz | 400mA
Systemleistung: 5,5W
Material: Edelstahl316/Glas

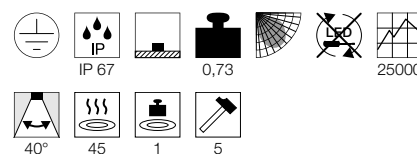

Maßzeichnung

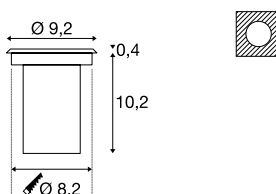

Hinweis

Einbautopf inkl.
Offenes Kabelend

Variante	Art. Nr.
300lm 3000K CRI>80 ■ edelstahl gebürstet	233530
360lm 4000K CRI>80 ■ edelstahl gebürstet	1002187



1002187 727



233712 727

DASAR® 100 PREMIUM EL, square

A-A++ Spektrum
A++-E

LED INSIDE PERLUCOR®



- 5 Mal härter und 100 Mal kratzbeständiger als herkömmliches Glas
- Blende: Edelstahl 316L
- Das Glas ist thermisch, chemisch, mechanisch und optisch beständig. Tritt- und kratzfest. Nahezu selbstreinigende Oberfläche. Ext em belastbar.

Produktangaben

220-240V ~50/60Hz | 400mA
Systemleistung: 5,5W
Material: Aluminium/Edelstahl316L/Glas

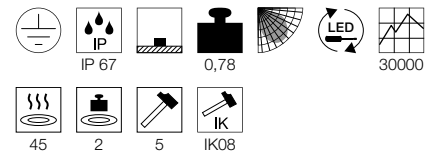

Maßzeichnung

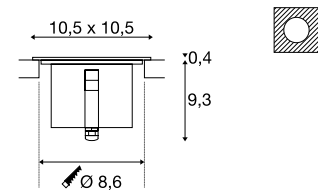

Hinweis

Exkl. Bodeneinbaurohr oder Topf.
Mit Einbaurohr (233790) 2t belastbar.
Mit Bodeneinbautopf (1000653) 0,5t belastbar.
Geeignet für Einbaurohre
Offenes Kabelend
Befestigungsklammer inkl.

Zubehöreffahrung

- T-Verbindebox
Art. Nr. 228726 
- Einbaurohr DN90
Art. Nr. 233790 
- DN90 Montagefeder für Holzeinbau
Art. Nr. 233795 
- Bodeneinbautopf
Art. Nr. 1000653 

Variante	Art. Nr.
300lm 3000K CRI>80 24°	
■ edelstahl	233692
300lm 3000K CRI>80 60°	
■ edelstahl	233696

DASAR® 100 PREMIUM
EL, round



- 5 Mal härter und 100 Mal kratzbeständiger als herkömmliches Glas
- Blende: Edelstahl 316L
- Das Glas ist thermisch, chemisch, mechanisch und optisch beständig. Tritt- und kratzfest. Nahezu selbstreinigende Oberfläche. Ext em belastbar.

Produktangaben

220-240V ~50/60Hz | 400mA
Systemleistung: 5,5W
Material: Aluminium/Edelstahl316L/Glas

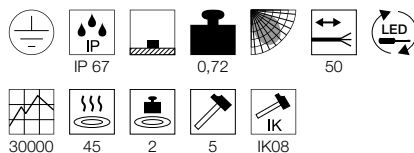

Maßzeichnung

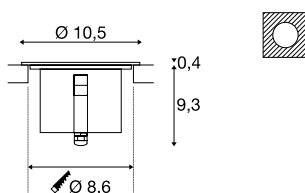

Hinweis

Exkl. Bodeneinbaurohr oder Topf.
Mit Einbaurohr (233790) 2t belastbar.
Mit Bodeneinbautopf (1000653) 0,5t belastbar.
Geeignet für Einbaurohre
Offenes Kabelend
Befestigungsklammer inkl.

Zubehörempfehlung

- T-Verbinderbox
Art. Nr. 228726
- Einbaurohr DN90
Art. Nr. 233790
- DN90 Montagefeder für Holzeinbau
Art. Nr. 233795
- Bodeneinbautopf
Art. Nr. 1000653

Variante	Art. Nr.
300lm 3000K CRI>80 24° ■ edelstahl	233672
300lm 3000K CRI>80 60° ■ edelstahl	233676

DASAR® 150 PREMIUM
EL, round



- 5 Mal härter und 100 Mal kratzbeständiger als herkömmliches Glas
- Blende: Edelstahl 316L
- Das Glas ist thermisch, chemisch, mechanisch und optisch beständig. Tritt- und kratzfest. Nahezu selbstreinigende Oberfläche. Ext em belastbar.

Produktangaben

220-240V ~50/60Hz | 620mA
Systemleistung: 17W
Material: Aluminium/Edelstahl316L/Glas

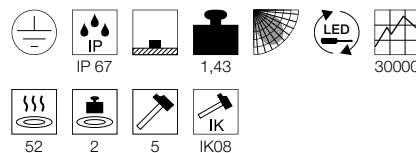

Maßzeichnung

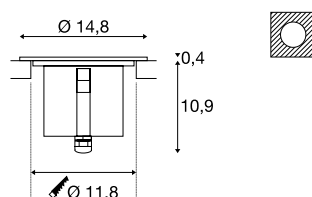

Hinweis

Exkl. Bodeneinbaurohr oder Topf.
Mit Einbaurohr (233791) 2t belastbar.
Mit Bodeneinbautopf (1000654) 0,5t belastbar.
Geeignet für Einbaurohre
Offenes Kabelend
Befestigungsklammer inkl.

Zubehörempfehlung

- T-Verbinderbox
Art. Nr. 228726
- Einbaurohr DN125
Art. Nr. 233791
- DN125 Montagefeder für Holzeinbau
Art. Nr. 233796
- Bodeneinbautopf
Art. Nr. 1000654

Variante	Art. Nr.
1200lm 3000K CRI>80 30° ■ edelstahl	233712
1200lm 3000K CRI>80 60° ■ edelstahl	233716

DASAR® 150 PREMIUM
EL, square



- 5 Mal härter und 100 Mal kratzbeständiger als herkömmliches Glas
- Blende: Edelstahl 316L
- Das Glas ist thermisch, chemisch, mechanisch und optisch beständig. Tritt- und kratzfest. Nahezu selbstreinigende Oberfläche. Ext em belastbar.

Produktangaben

220-240V ~50/60Hz | 620mA
Systemleistung: 17W
Material: Aluminium/Edelstahl316L/Glas

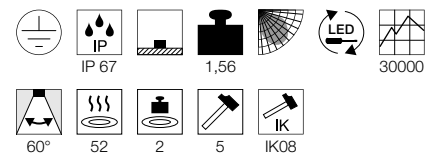

Maßzeichnung

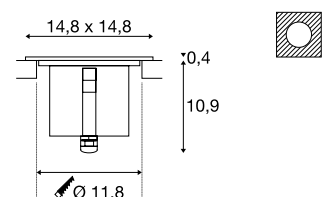

Hinweis

Exkl. Bodeneinbaurohr oder Topf.
Mit Einbaurohr (233791) 2t belastbar.
Mit Bodeneinbautopf (1000654) 0,5t belastbar.
Geeignet für Einbaurohre
Offenes Kabelend
Befestigungsklammer inkl.

Zubehörempfehlung

- T-Verbinderbox
Art. Nr. 228726
- Einbaurohr DN125
Art. Nr. 233791
- DN125 Montagefeder für Holzeinbau
Art. Nr. 233796
- Bodeneinbautopf
Art. Nr. 1000654

Variante	Art. Nr.
1200lm 3000K CRI>80 30° ■ edelstahl	233732
1200lm 3000K CRI>80 60° ■ edelstahl	233736



229320 729



229374 729



229324 728

DASAR® 80
EL, square/round, QPAR51



- Blende: Edelstahl 316

Produktangaben

230V ~50Hz
Material: Edelstahl316/Aluminium/Glas



Maßzeichnung

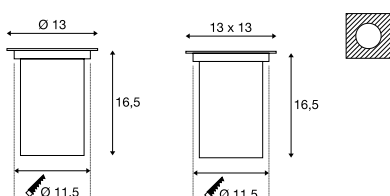

Hinweis

Einbautopf inkl.

Leuchtmittlempfehlung

LED GU10 5,5W 38°
3000K 440lm EEK=A+
6kWh/1000h | **3 Step-Dim**
Art. Nr. 551902



LED GU10 7,2W 36°
3000K 570lm EEK=A+
8kWh/1000h
Art. Nr. 1001562



Leuchtmittelangaben

35W max.
Ø: 5 cm max. L: 6 cm max.
optional: LED

Variante	Art. Nr.
GU10 QPAR51	
edelstahl	229320
GU10 QPAR51	
edelstahl	229324

DASAR® 70
EL, square, QPAR51



- Blende: Edelstahl 304

Produktangaben

230V ~50Hz
Material: Edelstahl304/Aluminium/Glas

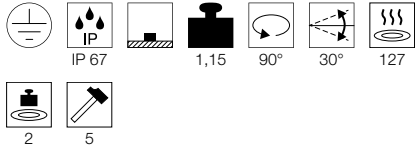

Maßzeichnung

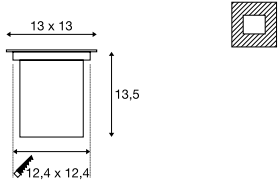

Hinweis

Einbautopf inkl.

Leuchtmittlempfehlung

LED GU10 5,5W 36°
2800K 500lm EEK=A+
6kWh/1000h
Art. Nr. 1001217



LED GU10 5,5W 38°
2700K 400lm EEK=A+
6kWh/1000h | **3 Step-Dim**
Art. Nr. 1001030



Leuchtmittelangaben

35W max.
Ø: 5 cm max. L: 6 cm max.
optional: LED

Variante	Art. Nr.
GU10 QPAR51	
edelstahl	229374

DASAR® EXACT 116
EL, square/round, QPAR51

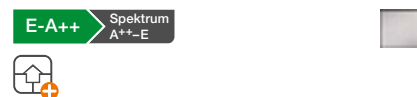

- Blende: Edelstahl 316
- Für bodenbündigen Einbau

Produktangaben

230V ~50Hz
Material: Edelstahl316/Aluminium/Glas

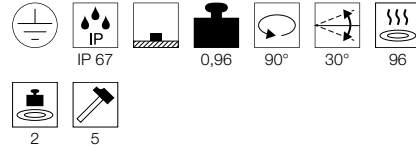

Maßzeichnung

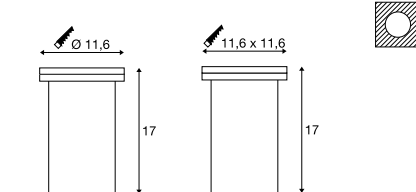

Hinweis

Einbautopf inkl.

Leuchtmittlempfehlung

LED GU10 5,5W 38°
3000K 440lm EEK=A+
6kWh/1000h | **3 Step-Dim**
Art. Nr. 551902



LED GU10 7,2W 36°
3000K 570lm EEK=A+
8kWh/1000h
Art. Nr. 1001562



Leuchtmittelangaben

35W max.
Ø: 5 cm max. L: 6 cm max.
optional: LED

Variante	Art. Nr.
GU10 QPAR51	
edelstahl gebürstet	228430
GU10 QPAR51	
edelstahl gebürstet	228434

DASAR® 215
EL, square/round, QPAR111

E-A++ Spektrum A++-E





- Blende: Edelstahl 316
- Geradliniges, edles Design für höchste Anpassungsfähigkeit

Produktangaben

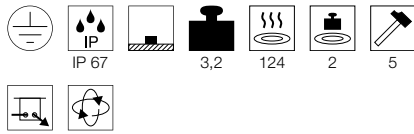
230V ~50Hz
Material: Edelstahl316/Aluminium/Glas

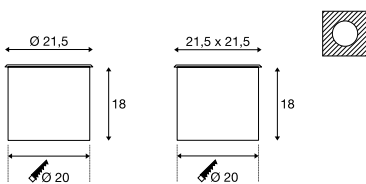

Maßzeichnung



Hinweis

Einbautopf inkl.

Leuchtmittlempfehlung

LED GU10 5,5W 36°
2800K 500lm EEK=A+
6kWh/1000h
Art. Nr. 1001217



LED GU10 5,5W 38°
2700K 400lm EEK=A+
6kWh/1000h | **3 Step-Dim**
Art. Nr. 1001030



Leuchtmittelangaben

75W max.
optional: LED

Variante	Art. Nr.
GU10 QPAR111	
edelstahl	229230
GU10 QPAR111	
edelstahl	229234

DASAR® 218
EL, QR111

D-A+ Spektrum A++-E





- Blende: Edelstahl 316
- Größerer Schwenkbereich als herkömmliche bodeneinbaustrahle

Produktangaben

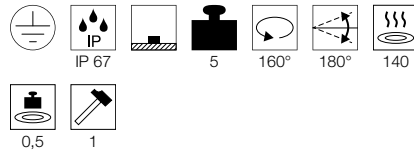
230V ~50Hz 12V AC
Material: Edelstahl316/Aluminium/Glas

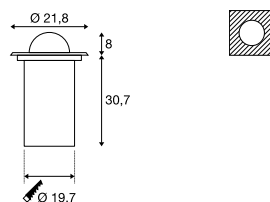

Maßzeichnung



Hinweis

Einbautopf inkl.

Leuchtmittlempfehlung

LED G53 9W 13°
4000K 800lm EEK=A+
10kWh/1000h
Art. Nr. 560624



LED G53 15W 24°
3000K 770lm EEK=A
17kWh/1000h
Art. Nr. 560233



Leuchtmittelangaben

50W max.
optional: LED

Variante	Art. Nr.
G53 QR111	
edelstahl	228370

DASAR® 215
EL, round, E27

A-A++ Spektrum A++-E





- Blende: Edelstahl 316
- Geradliniges, edles Design für höchste Anpassungsfähigkeit

Produktangaben

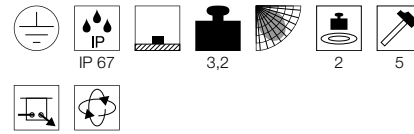
230V ~50Hz
Material: Edelstahl316/Aluminium/Glas

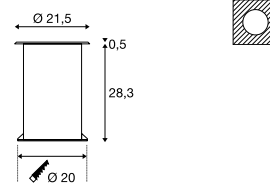

Maßzeichnung



Hinweis

Oberflächen emperatur: Energysaver = 48°C/
PAR 30 = 119°C/ PAR 38 = 108°C
Einbautopf inkl.

Leuchtmittlempfehlung

LED E27 9W 240°
3000K 810lm EEK=A+
10kWh/1000h
Art. Nr. 1001031



Leuchtmittelangaben

11W max.
Ø: 4,5 cm max. L: 13,4 cm max.
optional: LED PAR30 PAR38

Variante	Art. Nr.
E27 TC(...)SE	
edelstahl	229200





1002893 733



DASAR® 255 EL

A-A++ Spektrum A++-E



- Blende: Edelstahl 316
- Asymmetrischer Reflektor

Produktangaben

220-240V ~50/60Hz 750mA
Systemleistung: 34W
Material: Edelstahl316/Aluminium/Glas

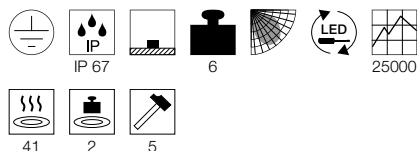

Maßzeichnung

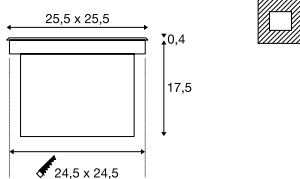

Hinweis

Einbautopf inkl.

DASAR® 270 EL, asymmetrisch

A-A++ Spektrum A++-E



- Asymmetrische Lichtverteilung

Produktangaben

220-240V ~50/60Hz | 700mA
Systemleistung: 30W
Material: Aluminium / Edelstahl 316
Produktmaße: Ø: 27 cm H: 20,3 cm
Einbaumaße: Einbau-Ø: 25 cm T: 19,9 cm

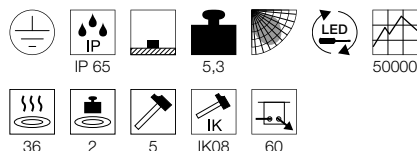

Hinweis

Einbautopf inkl.

DASAR® 270 EL, symmetrisch

A-A++ Spektrum A++-E



- Symmetrische Lichtverteilung
- Schwenkbarer Leuchtenkopf

Produktangaben

220-240V ~50/60Hz | 700mA
Systemleistung: 30W
Material: Aluminium / Edelstahl 316
Produktmaße: Ø: 27 cm H: 20,3 cm
Einbaumaße: Einbau-Ø: 25 cm T: 19,9 cm

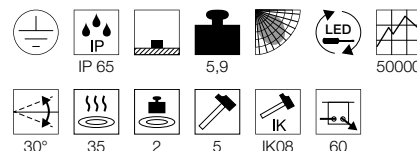

Hinweis

Einbautopf inkl.

Zubehöreffahrung

- Blendschutz
Art. Nr. 1002899



Variante	Art. Nr.
1620lm 4000K CRI>80 ■ edelstahl	229381
1620lm 3000K CRI>80 ■ edelstahl	229383

Variante	Art. Nr.
2000lm 3000K CRI>80 ■ matt schwarz / gebürstet edelstahl	1002893
2100lm 4000K CRI>80 ■ matt schwarz / gebürstet edelstahl	1002895

Variante	Art. Nr.
2500lm 3000K CRI>80 ■ matt schwarz / gebürstet edelstahl	1002897
2600lm 4000K CRI>80 ■ matt schwarz / gebürstet edelstahl	1002898

DASAR®
EL, T16

A-A+ Spektrum
A++-E



• Blende: Edelstahl 316

Produktangaben

230V ~50Hz
Systemleistung: 13,6W
Material: Edelstahl316/Aluminium/Glas

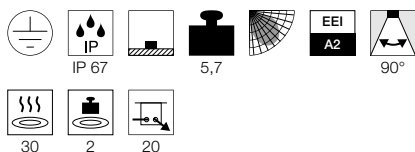

Maßzeichnung

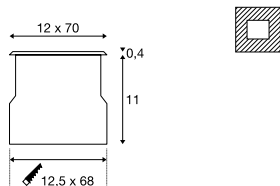

Hinweis

Einbautopf inkl.

Leuchtmittlempfehlung

G5 14W
3000K 1200lm EEK=A+
16kWh/1000h
Art. Nr. 548014

Leuchtmittelangaben

14W

Variante	Art. Nr.
G5 T16 ■ edelstahl	230100

DASAR®
EL, T16

A-A+ Spektrum
A+++E

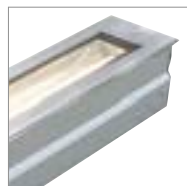

• Blende: Edelstahl 316

Produktangaben

230V ~50Hz
Systemleistung: 23,3W
Material: Edelstahl316/Aluminium/Glas

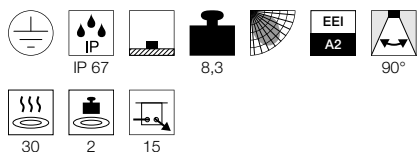

Maßzeichnung

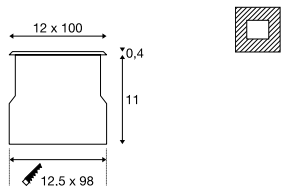

Hinweis

Einbautopf inkl.

Leuchtmittlempfehlung

G5 21W
3000K 1900lm EEK=A+
23kWh/1000h
Art. Nr. 548021

Leuchtmittelangaben

21W

Variante	Art. Nr.
G5 T16 ■ edelstahl	230110



230100 734



230100 734

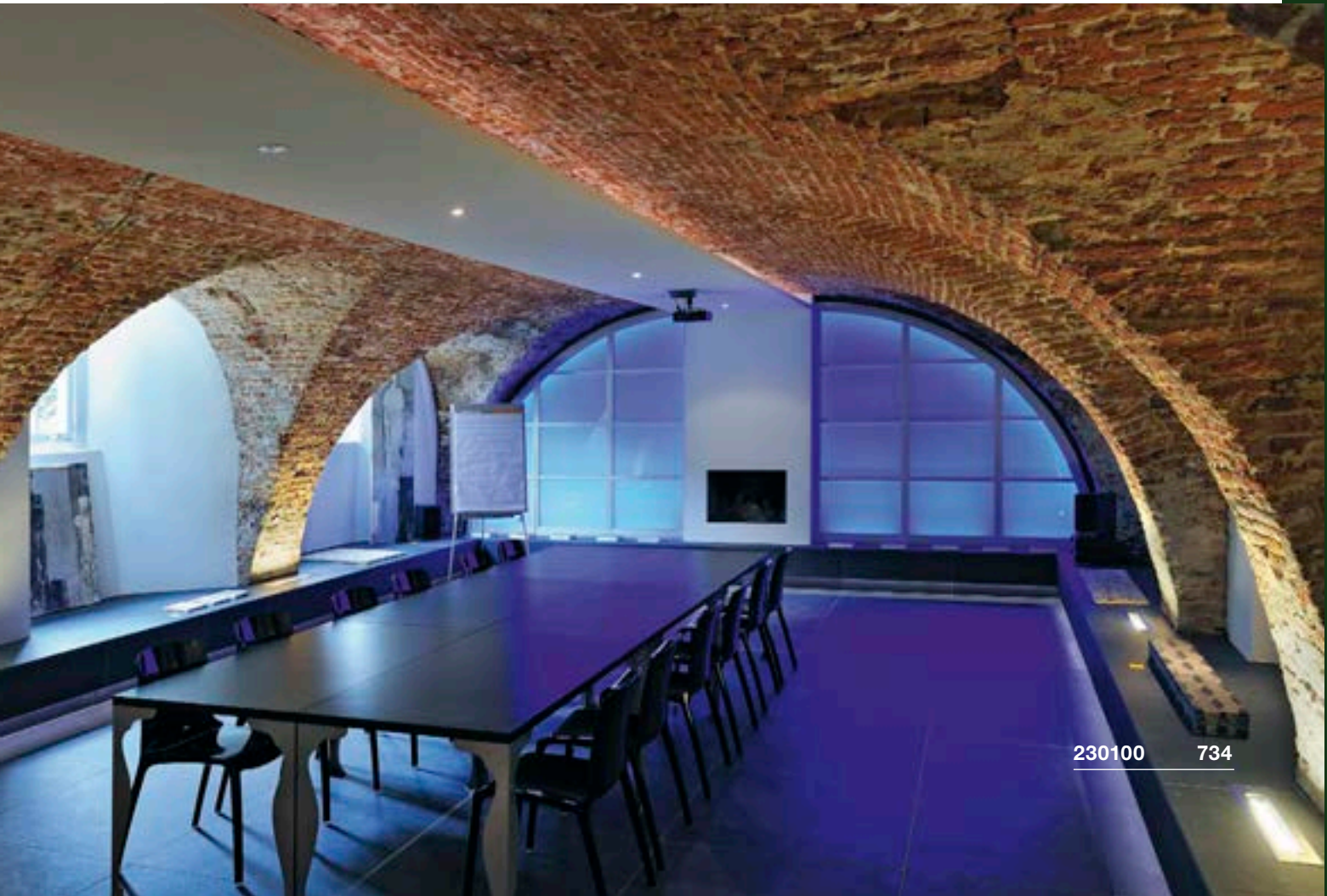

230100 734

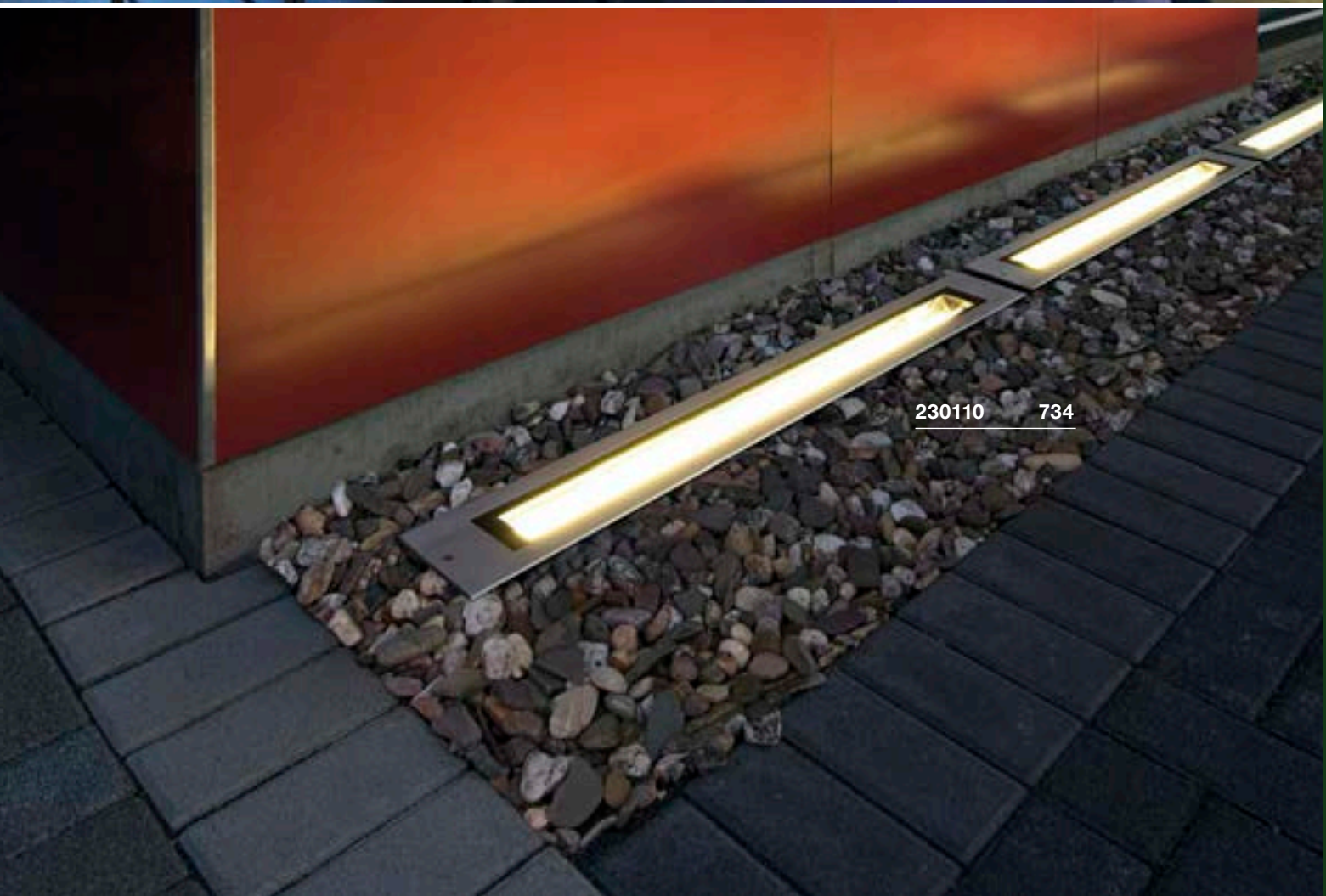

230110 734



FÜR HELLE KÖPFCHEN.

Sorgen Sie für ein sicheres Gefühl: mit unseren feuerfesten Lösungen für normgerecht erhöhten Brandschutz in F90-Decken. Und für den Notfall sind Sie mit den SLV Ein- und Aufbauleuchten für Fluchtwege gut gewappnet.

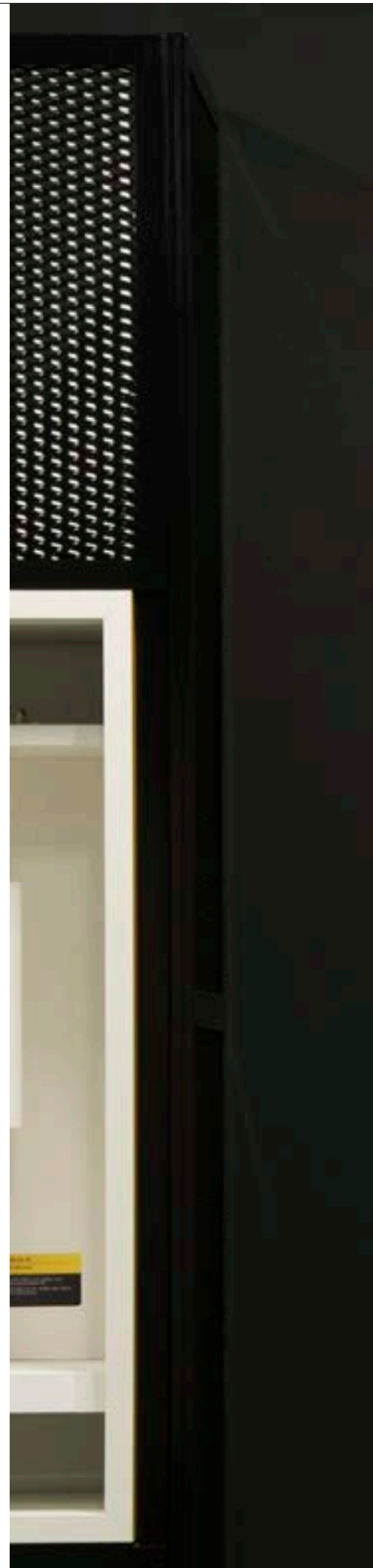



240000 740

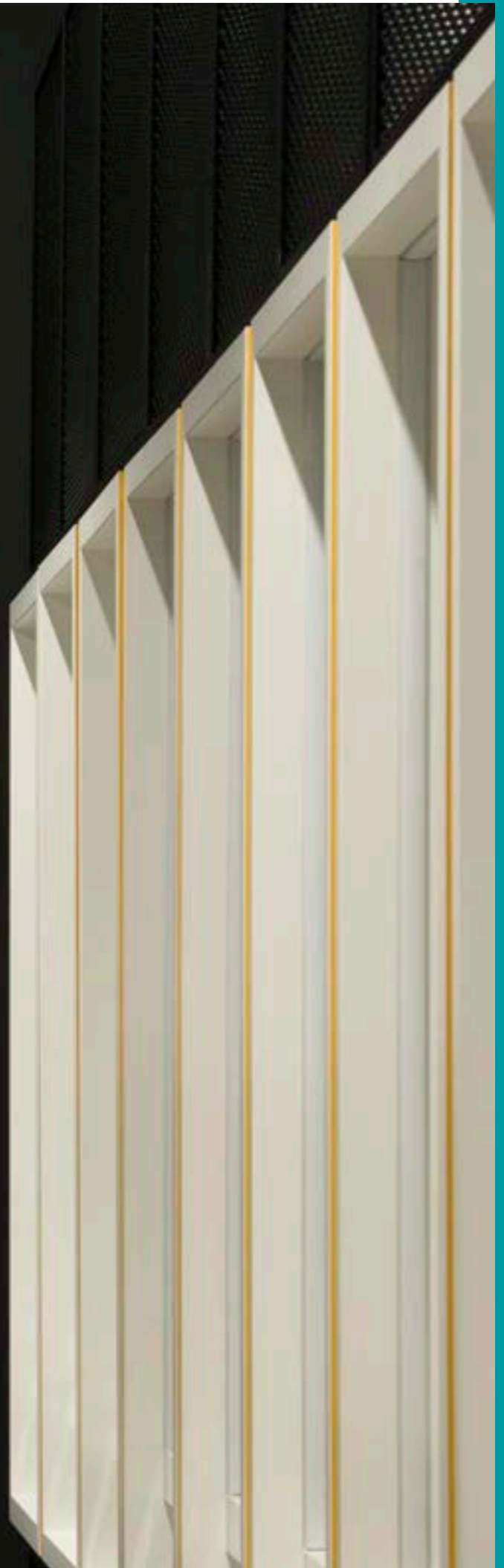

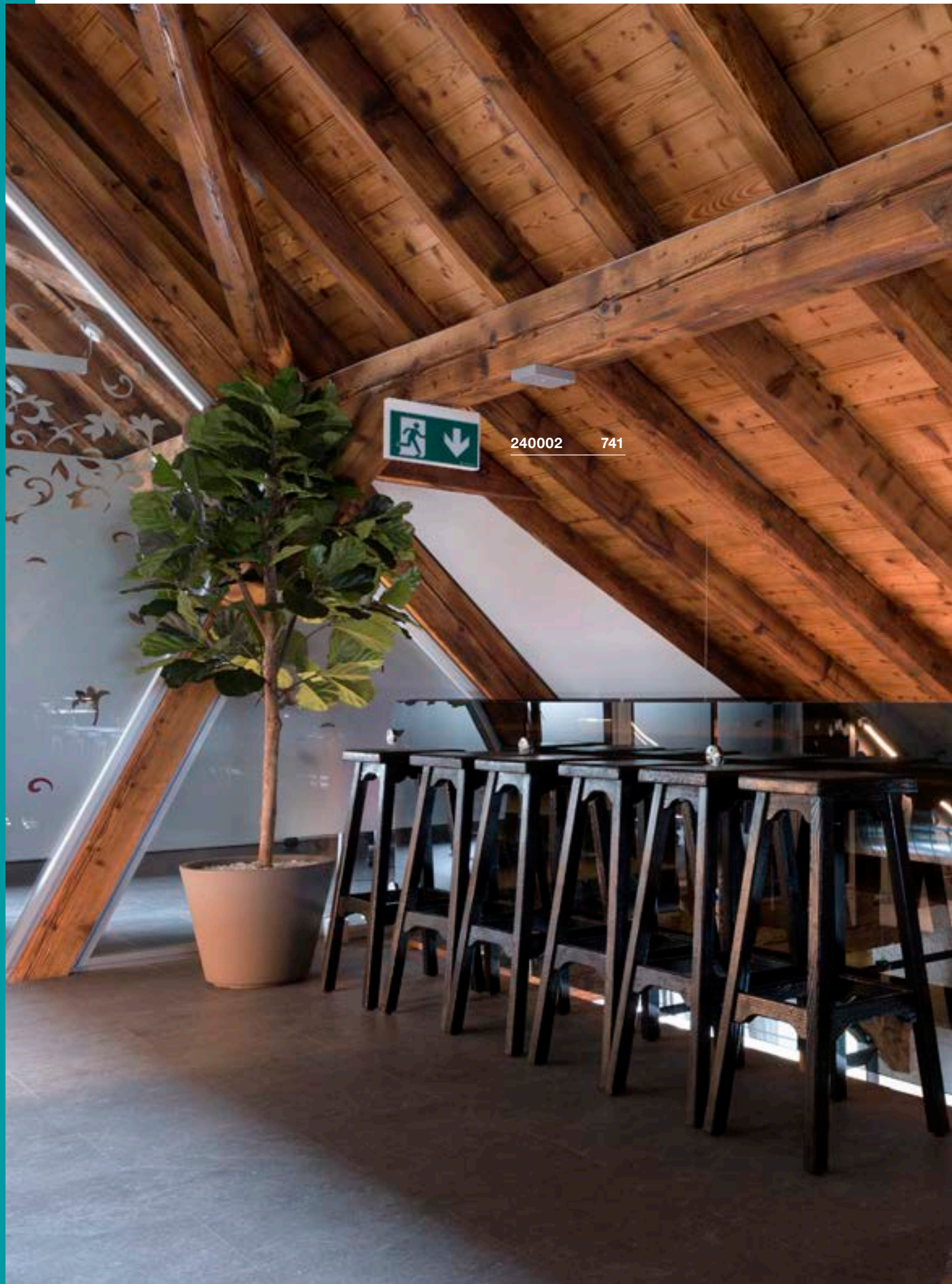

240002 741



240000 740



SICHERHEITSLÖSUNGEN

Weitere Leuchten und Varianten finden Sie online unter www.slv.com



P-LIGHT CW



A-A++ Spektrum
A++-E



- 24 m Erkennungsweite
- Einfache Montage
- Flexibel einsetzbar – als Deckenanbau- oder Wandanbauvariante
- Flache Notbeleuchtung mit effizienter LED-Technologie
- 4-teiliges Piktogrammset zum Einlegen beigelegt

Produktangaben

220-240V ~50Hz
 Systemleistung: 3,5W
 Material: ABS / Polycarbonat (PC)

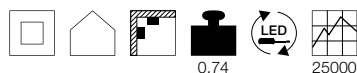

Maßzeichnung

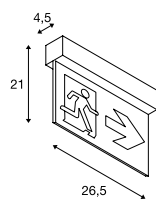

Hinweis

Erkennungsweite 24 m. 3 Rettungswegzeichen (rechts/links/runter) und 1 weiße Folie beigelegt. Notbeleuchtung mit eingebautem Ni-Mh Akku, mit automatischem Selbsttest. Notbetriebszeit 3 Std. Leuchtdichte >15cd/ m². Betriebsart: Dauerschaltung/Bereitschaft

Zubehöreffempfehlung

■ Akkumulator 3,6V | 900mA

Art. Nr. 240020

■ Piktogrammfolien, Set

Art. Nr. 240007



Variante	Art. Nr.
32lm 6000K CRI>70	
□ weiß	240000

Piktogrammfolien

Polypropylen (PP)
 B: 24 cm H: 13,1 cm



5-teiliges Piktogrammset zum Einlegen (links schräg hoch/ links schräg runter/ rechts schräg hoch/ rechts schräg runter/ nach oben). 1 Stk.

Variante	Art. Nr.
■ grün	240007



240000 740



240000 740



240002 741

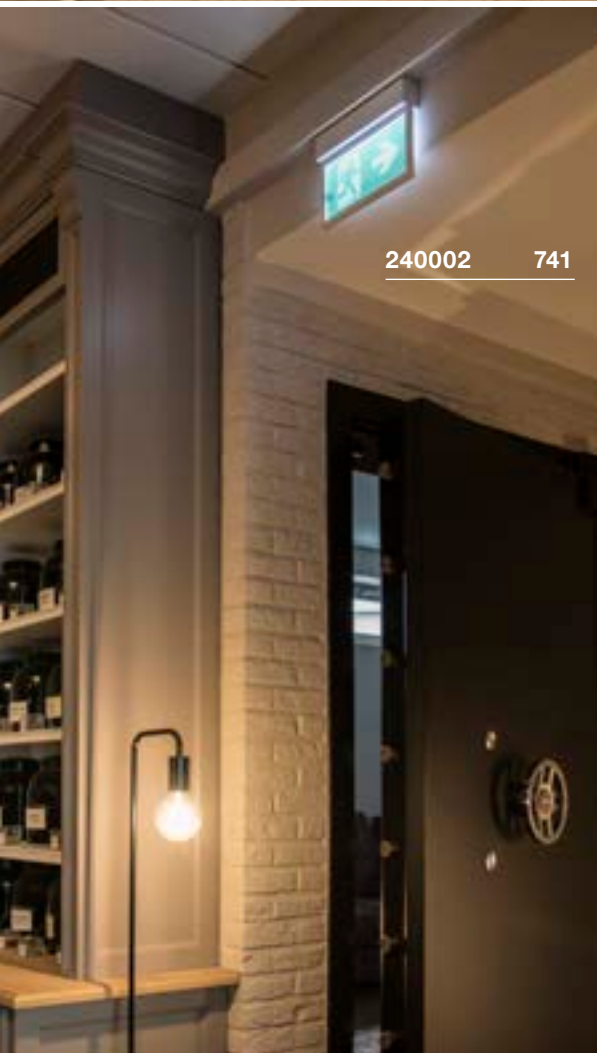

240002 741

Piktogrammfolien

Polypropylen (PP)
B: 30 cm H: 16,1 cm



5-teiliges Piktogrammset zum Einlegen (links schräg hoch/ links schräg runter/ rechts schräg hoch/ rechts schräg runter / nach oben).
1 Stk.

Variante **Art. Nr.**

■ grün 240008

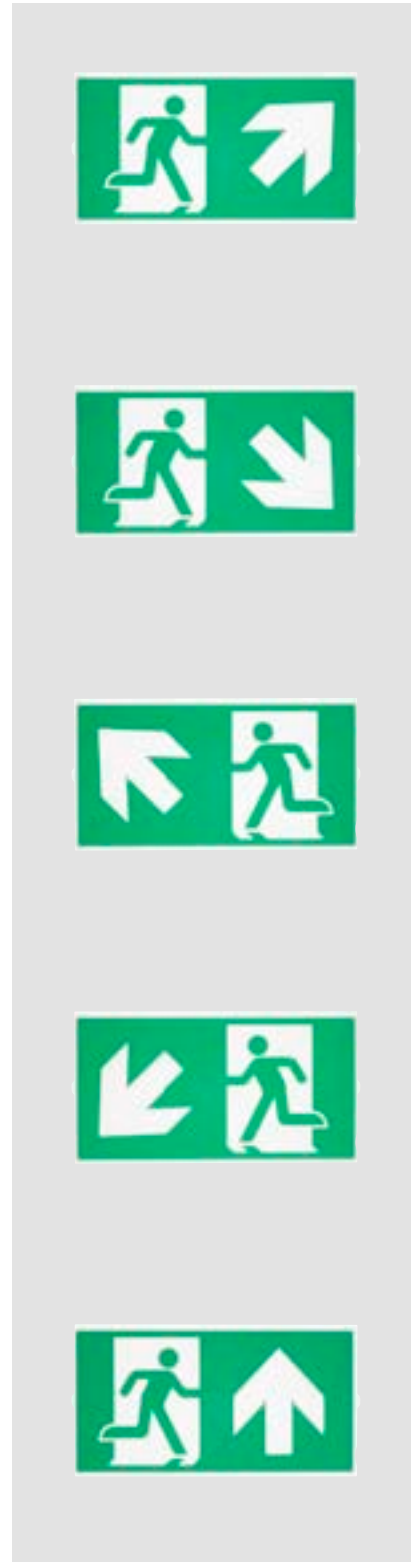

**P-LIGHT
CW**

894

A-A++ Spektrum A++-E

LED INSIDE



- 30 m Erkennungsweite
- Geprüft nach DIN EN 60598-2-22
- Flexibel einsetzbar – als Deckenanbau- oder Wandanbauvariante
- Sehr geringe Wartungskosten durch effiziente LED-Technologie
- 4-teiliges Piktogrammset zum Einlegen beigelegt
- Einfache Montage

Produktangaben

220-240V ~50/60Hz
Systemleistung: 4W
Material: ABS / Polycarbonat (PC)

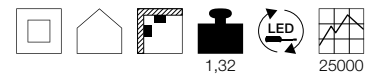

Maßzeichnung

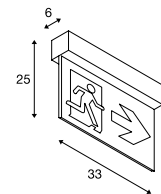

Hinweis

Erkennungsweite 30 m. 3 Rettungswegzeichen (rechts/links/runter) und 1 weiße Folie beigelegt. Notbeleuchtung mit eingebautem Ni-Mh Akku, mit automatischem Selbsttest. Notbetriebszeit 3 Std. Leuchtdichte >15cd/ m². Betriebsart: Dauerschaltung/Bereitschaft

Zubehörempfehlung

□ Akkumulator 3,6V | 1000mA

Art. Nr. 240021

■ Piktogrammfolien, Set

Art. Nr. 240008



Variante **Art. Nr.**

32lm | 6000K | CRI>70

□ weiß

240002



P-LIGHT CL



894

A-A++ Spektrum A++-E



- Geprüft nach DIN EN 60598-2-22
- Deckeneinbauvariante mit effizienter LED-Technologie

Produktangaben

220-240V ~50Hz
 Systemleistung: 5W
 Material: ABS / Polycarbonat (PC)

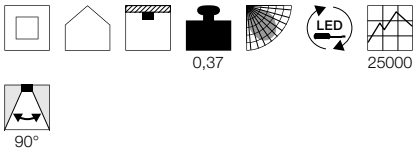

0,37

25000

Maßzeichnung

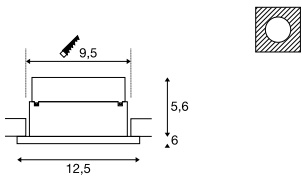

Hinweis

Als Notbeleuchtung einsetzbar. Auto Test Funktion, Ni-Mh Akku 2x 3,6V 1.5Ah inklusiv. Notbetrieb über Akku 3 Std. Halbstreuwinkel 90°, Materialstärke Einbaufäche: 25 mm max

Zubehöreffahrung

Akkumulator 7,2V | 1000mA
 Art. Nr. 240024



Variante	Art. Nr.
120lm 6000K CRI>70	
<input type="checkbox"/> weiß	240006

240006 702





240004 743

152980 349

P-LIGHT
CW



A-A++ Spektrum A++-E



- 30 m Erkennungsweite
- IP 65 Leuchte mit effizienter LED-Technologie
- Geprüft nach DIN EN 60598-2-22
- Flexible einsetzbar – als Deckenanbau- oder Wandanbauvariante
- Einfache Montage

Produktangaben

220-240V ~50Hz
Systemleistung: 6,5W
Material: Polycarbonat (PC)

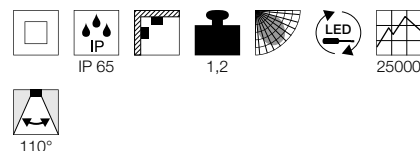

Maßzeichnung

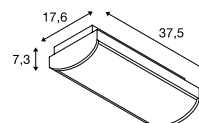

Piktogrammfolien

Polypropylen (PP)
B: 35,3 cm H: 16,5 cm



2-teiliges Piktogrammset zum Einlegen (rechts schräg hoch/ rechts schräg runter)
1 Stk.

Variante	Art. Nr.
■ grün	240010

Piktogrammfolien

Polypropylen (PP)
B: 35,3 cm H: 16,5 cm



3-teiliges Piktogrammset zum Einlegen (oben, unten, rechts)
1 Stk.

Variante	Art. Nr.
■ grün	240009



Hinweis

Erkennungsweite 30 m. Verwendung als Notbeleuchtung. Auto Test Funktion, Ni-Mh Akku 2x 3,6V 1.0Ah inklusiv. Notbetrieb über Akku 2 Std. Rettungswegzeichen optional erhältlich und als Nothinweisleuchte verwendbar.

Zubehörempfehlung

- Akkumulator 3,6V | 1000mA, 2 Stk. Art. Nr. 240022
- Piktogrammfolien, Set Art. Nr. 240009
- Piktogrammfolien, Set Art. Nr. 240010

Variante	Art. Nr.
100lm 6000K CRI>70	
<input type="checkbox"/> weiß	240004



1001015 745

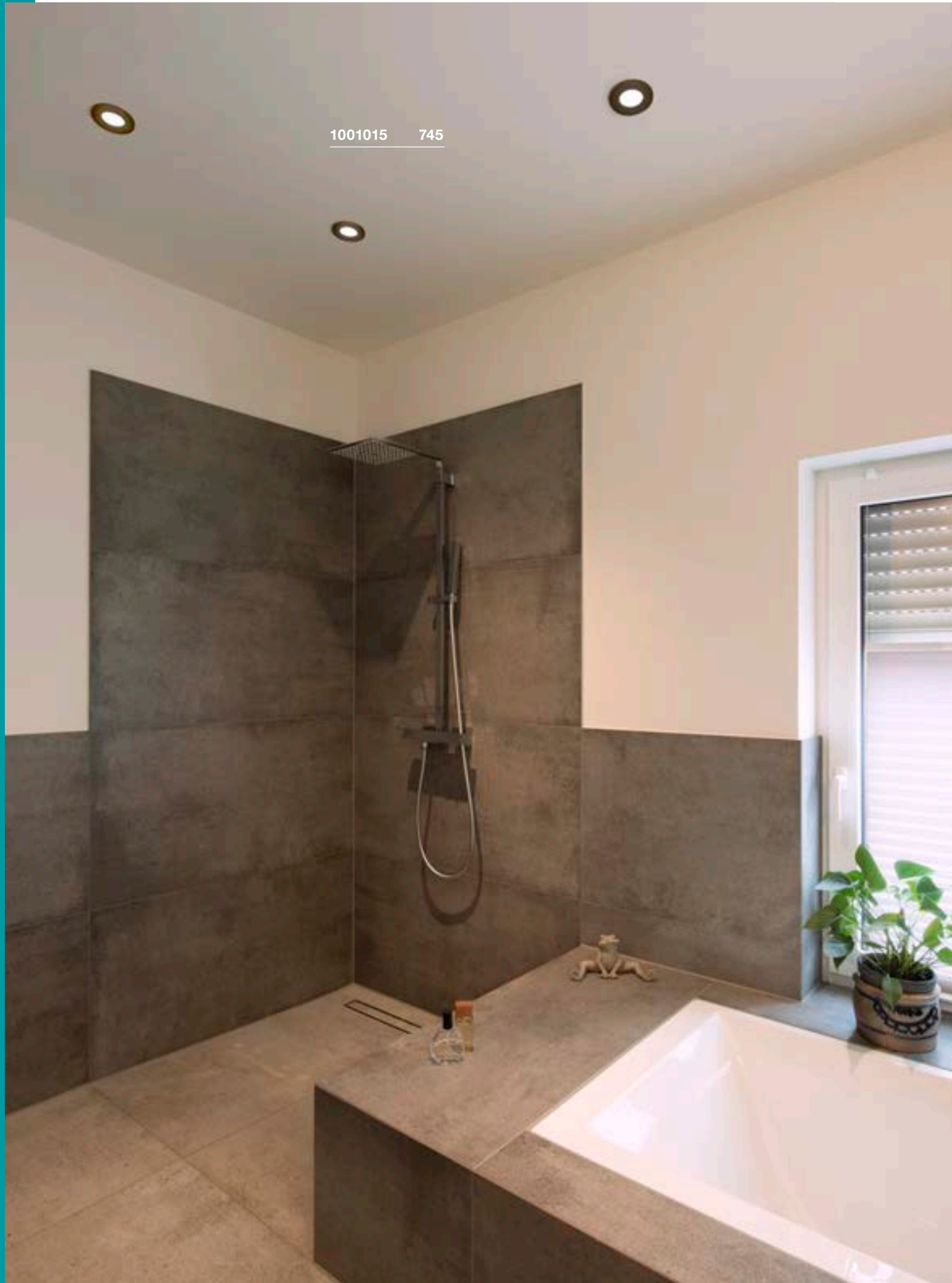



1001017 745

KAMUELA ECO
EL, round, TRIACA-A++ Spektrum
A++-E

- Feuerbeständig für mind. 90 Minuten nach BS 476-21
- LED-Lebensdauer 35.000h
- IP 65 Leuchte mit effizienter LED-Technologie

Produktangaben

220-240V ~50Hz
Systemleistung: 6,5W
Material: Aluminium / Kunststoff
Dimmbar: Triac C, Triac L

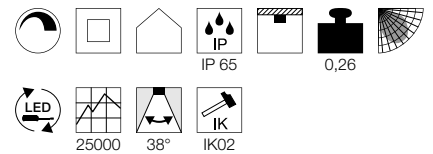
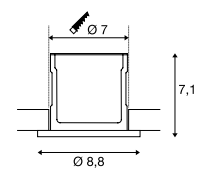
**Maßzeichnung****Hinweis**

Materialstärke Einbaufäche: 40 mm max









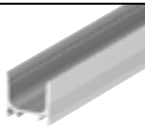
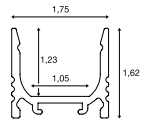
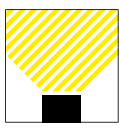
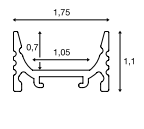
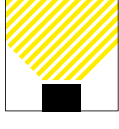
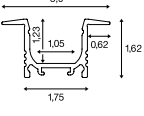
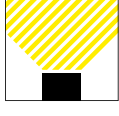

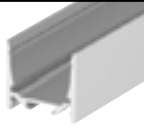
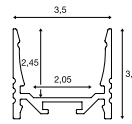
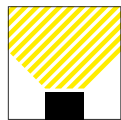
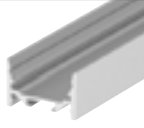
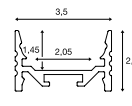
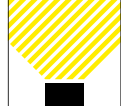
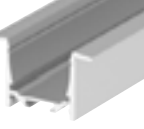
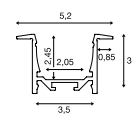
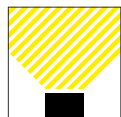
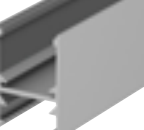
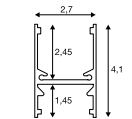
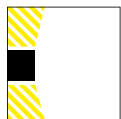

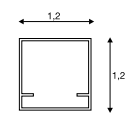
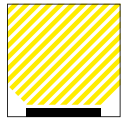
Variante	Art. Nr.
400lm 3000K CRI>80	
■ schwarz	1001015
400lm 3000K CRI>80	
□ weiß	1001016
400lm 4000K CRI>80	
■ schwarz	1001017
400lm 4000K CRI>80	
□ weiß	1001018

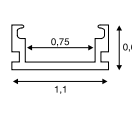
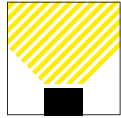
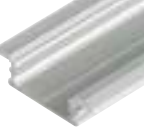
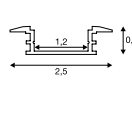
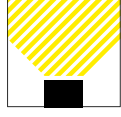
LED-PROFILE

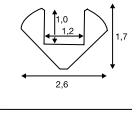
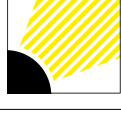
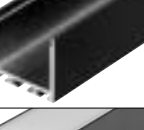
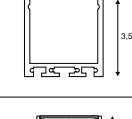
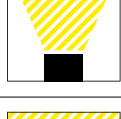
ÜBERSICHT

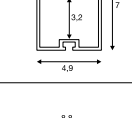
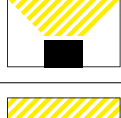

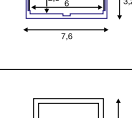
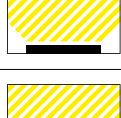
LED-Profi		Montageart			Querschnitt	Abstrahlwinkel	Seite
		Aufbau	Einbau	Pendel			
Standard		✓	-	-			749
GRAZIA 10	Flach	✓	-	-			749
	Einbau	-	✓	-			749

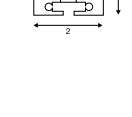
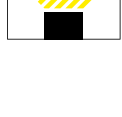
LED-Profi	Montageart			Querschnitt	Abstrahlwinkel	Seite		
	Aufbau	Einbau	Pendel					
Standard		✓	-	✓			753	
GRAZIA 20	Flach		✓	-	✓			753
	Einbau		-	✓	-			754
H-PROFIL		✓	-	✓			758	
KENAI		✓	-	-			762	
GLENOS Linear-Profil 110		✓	-	-			764	
GLENOS Linear-Einbau-Profil 250		-	✓	-			766	
GLENOS Eck-Profil 272		✓	-	-			768	
GLENOS Profi- rofil 303		✓	-	✓			770	
GLENOS Profi- rofil 497		✓	-	✓			772	
GLENOS Profi-Einbau- rofil 883		-	✓	-			774	
GLENOS Profi- rofil 202		✓	-	-			776	



Passende LED-Stripes und Komponenten finden Sie ab Seite 778 und das passende Zubehör (Netzteile, Treiber, etc.) ab Seite 842

GRAZIA 10

AUF- UND EINBAUPROFIL

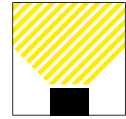

AUFBAUPROFIL, STANDARD

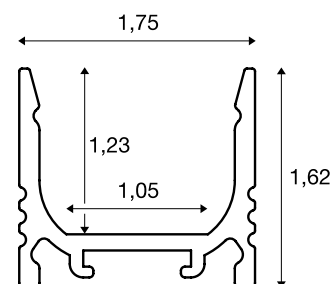
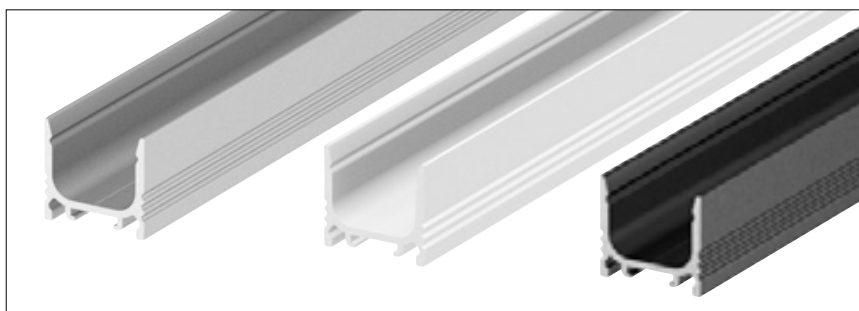

Aufbauprofil, standard, aluminium, weiß, schwarz

Länge	Farbe	Gewicht (kg)	Art. Nr.
200 cm	aluminium	0,35	1000463
	weiß	0,46	1000464
	schwarz	0,46	1000465

Material: Aluminium, Breite/Höhe: 1,75/1,62 cm, max. Breite LED-Strip: 1,0 cm, Abdeckung exkl.

AUFBAUPROFIL, FLACH

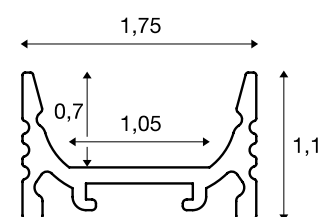

Aufbauprofil, Flach, aluminium, weiß, schwarz

Länge	Farbe	Gewicht (kg)	Art. Nr.
200 cm	aluminium	0,27	1000460
	weiß	0,36	1000461
	schwarz	0,36	1000462

Material: Aluminium, Breite/Höhe: 1,75/1,1 cm, max. Breite LED-Strip: 1,0 cm, Abdeckung exkl.

EINBAUPROFIL

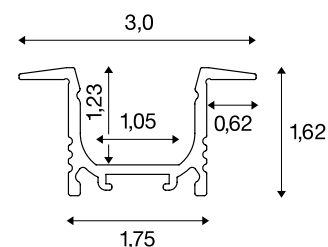
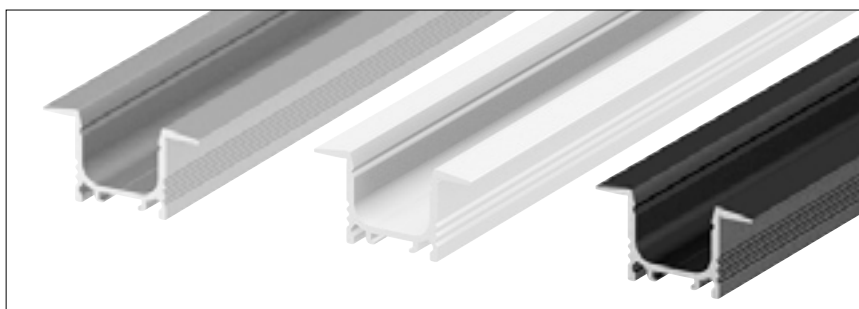

Einbauprofil, aluminium, weiß, schwarz

Länge	Farbe	Gewicht (kg)	Art. Nr.
200 cm	aluminium	0,42	1000457
	weiß	0,53	1000458
	schwarz	0,53	1000459

Material: Aluminium, Breite/Höhe: 3,0/1,62 cm, max. Breite LED-Strip: 1,0 cm, Abdeckung exkl.

GRAZIA 10

ZUBEHÖR

ABDECKUNGEN

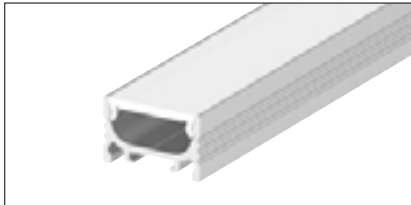

flach, milchi

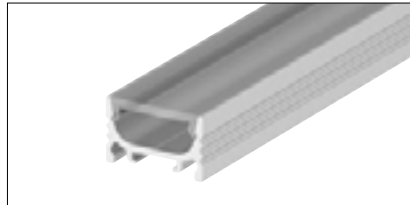

flach, ansparent

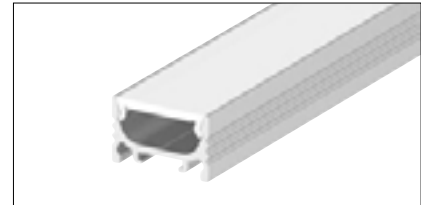

flach, matt t ansparent

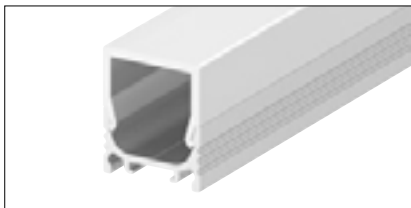

hoch, milchig (nur für Aufbauprofile geeignet)

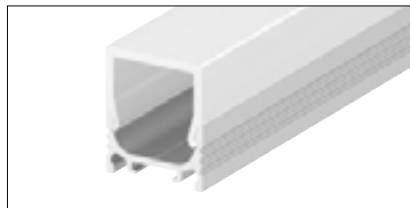

hoch, matt transparent (nur für Aufbauprofil geeignet)

Länge	Farbe	Material	Art. Nr.
200 cm	flach, milchi	Kunststoff P	1000466
	flach, milchi	Kunststoff PMM	1000468
	flach, t ansparent	Kunststoff P	1000467
	flach, matt t ansparent	Kunststoff PMM	1000469
	hoch, milchig *	Kunststoff P	1000470
	hoch, matt transparent *	Kunststoff P	1000471

Kunststoff PMMA/PC

Profil-Abdeckungen aus PMMA sind besonders homogen

Profil-Abdeckungen aus PC sind bruchsicher und eignen sich sehr gut für Anwendungen mit hohem Anspruch an die Widerstandsfähigkeit.

* Die hohen Abdeckungen sind nur für GRAZIA 10 Aufbauprofile geeignet, nicht für die Einbauprofile

MONTAGECLIPS

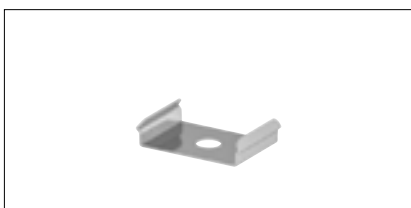

Montageclip, nicht sichtbar



Montageclip, sichtbar



Montageclip, 45°

Beschreibung	Maße	Art. Nr.
Montageclip, nicht sichtbar	B/H/T: 1,53/0,3/1 cm	1000487
Montageclip, sichtbar	B/H/T: 1,87/0,7/1 cm	1000488
Montageclip, 45°	B/H/T: 1,62/1,62/1 cm	1000489

Material: Edelstahl, Verpackungseinheit: 2 Stück

ENDKAPPEN FÜR AUFBAUPROFILE

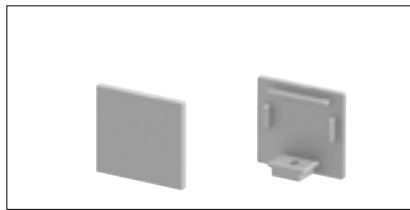

für Profil tandard, Abdeckung flac

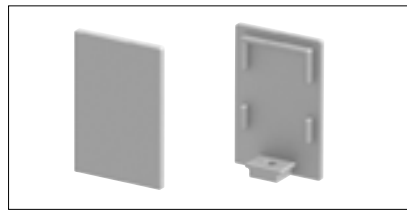

für Profil tandard, Abdeckung hoch

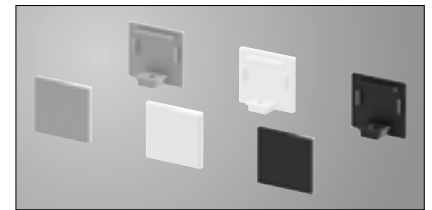

erhältliche Farbvarianten

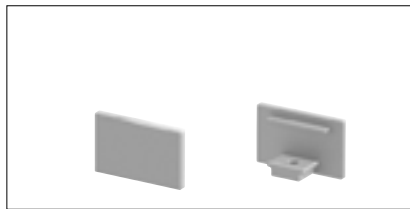

für Profil flach, Abdeckung fl

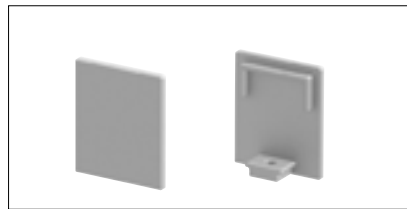

für Profil flach, Abdeckung ho

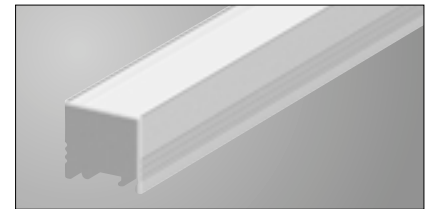

Profil mit montie ter Endkappe

Beschreibung	Farbe	sichtbare Tiefe	Art. Nr.
Endkappe für Profil tandard, Abdeckung flac	aluminium	0,2 cm	1000478
	weiß		1000479
	schwarz		1000480
Endkappe für Profil tandard, Abdeckung hoch	aluminium	0,2 cm	1000484
	weiß		1000485
	schwarz		1000486
Endkappe für Profil flac Abdeckung flac	aluminium	0,2 cm	1000475
	weiß		1000476
	schwarz		1000477
Endkappe für Profil flac Abdeckung hoch	aluminium	0,2 cm	1000481
	weiß		1000482
	schwarz		1000483

Material: Aluminium, Verpackungseinheit: 2 Stück

ENDKAPPEN FÜR EINBAUPROFIL

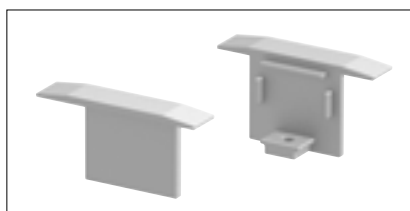

für Einbauprofi

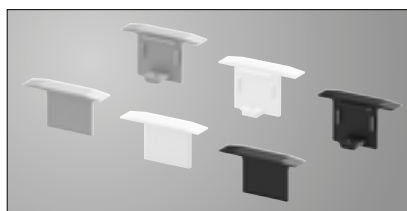

erhältliche Farbvarianten

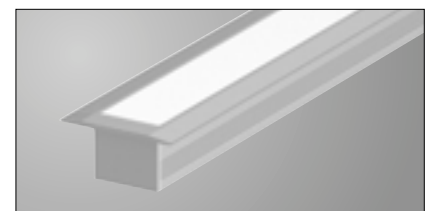

Profil mit montie ter Endkappe

Beschreibung	Farbe	sichtbare Tiefe	Art. Nr.
Endkappe für Einbauprofi	aluminium	0,7 cm	1000472
	weiß		1000473
	schwarz		1000474

Material: Aluminium, Verpackungseinheit: 2 Stück



Bitte beachten Sie, dass bei der Verwendung von Endkappen die sichtbare Tiefe von der Profillänge abg zogen werden muss, um die gewünschte Gesamtlänge zu erhalten.

sichtbare Tiefe Endkappen + Profillänge = Gesamtläng

GRAZIA 20

AUFBAUPROFIL

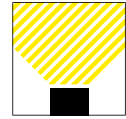

auch als Pendelleuchte verwendbar (Pendelabhängung s. S. 757)

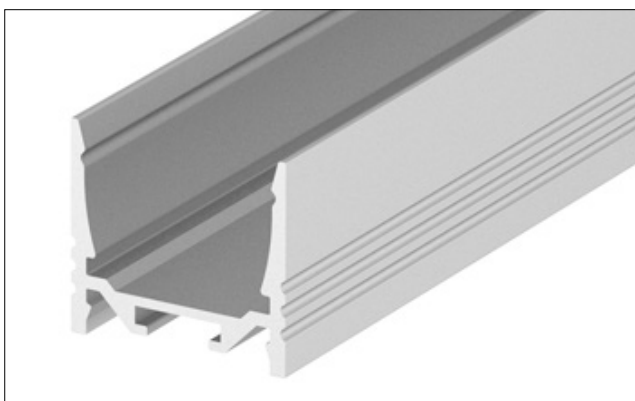

hochwertige pulverbeschichtete Aluminiumoberfläch



erhältliche Farbvarianten: aluminium, weiß, schwarz



STANDARD

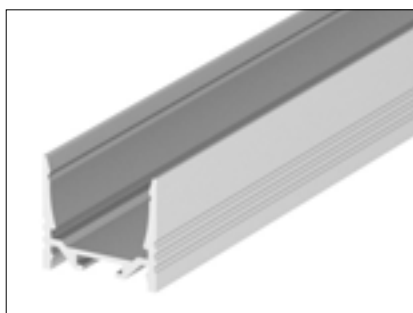

gerillt



glatt

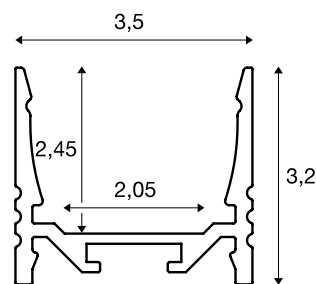

Beschreibung	Länge	Farbe	Gewicht (kg)	Art. Nr.
Standard gerillt	100 cm	aluminium	0,8	1000508
		weiß	0,82	1000509
		schwarz	0,82	1000510
	200 cm	aluminium	1,6	1000511
		weiß	1,64	1000512
		schwarz	1,64	1000513
300 cm	aluminium	2,4	1000514	
	weiß	2,46	1000515	
	schwarz	2,46	1000516	
Standard glatt	100 cm	aluminium	0,83	1000517
		weiß	0,85	1000518
		schwarz	0,85	1000519
	200 cm	aluminium	1,66	1000520
		weiß	1,7	1000521
		schwarz	1,7	1000522
	300 cm	aluminium	2,49	1000523
		weiß	2,55	1000524
		schwarz	2,55	1000525

Material: Aluminium, Breite/Höhe: 3,5/3,2 cm, max. Breite LED-Strip: 2,0 cm, Abdeckung exkl.

FLACH

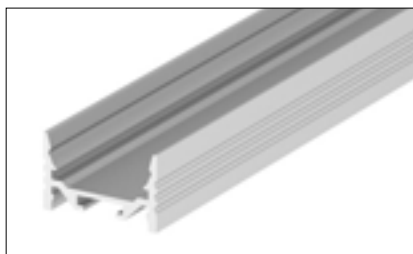

gerillt



glatt

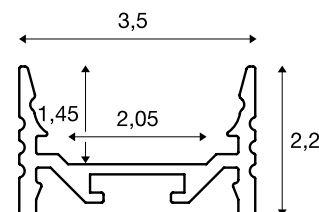

Beschreibung	Länge	Farbe	Gewicht (kg)	Art. Nr.
Flach gerillt	100 cm	aluminium	0,49	1000499
		weiß	0,51	1000500
		schwarz	0,51	1000501
	200 cm	aluminium	0,98	1000502
		weiß	1,02	1000503
		schwarz	1,02	1000504
300 cm	aluminium	1,47	1000505	
	weiß	1,53	1000506	
	schwarz	1,53	1000507	
Flach glatt	100 cm	aluminium	0,52	1000526
		weiß	0,54	1000527
		schwarz	0,54	1000528
	200 cm	aluminium	1,04	1000529
		weiß	1,08	1000530
		schwarz	1,08	1000531
	300 cm	aluminium	1,56	1000532
		weiß	1,62	1000533
		schwarz	1,62	1000534

Material: Aluminium, Breite/Höhe: 3,5/2,2 cm, max. Breite LED-Strip: 2,0 cm, Abdeckung exkl.

GRAZIA 20

EINBAUPROFIL

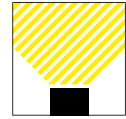

EINBAUPROFIL



Einbauprofil, aluminium, weiß, schwarz

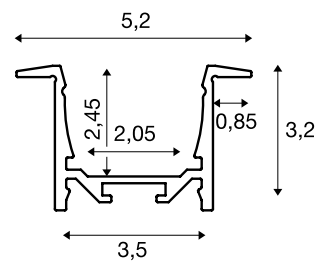

Länge	Farbe	Gewicht (kg)	Art. Nr.
100 cm	aluminium	0,76	1000490
	weiß	0,78	1000491
	schwarz	0,78	1000492
200 cm	aluminium	1,52	1000493
	weiß	1,56	1000494
	schwarz	1,56	1000495
300 cm	aluminium	2,28	1000496
	weiß	2,34	1000497
	schwarz	2,34	1000498

Material: Aluminium, Breite/Höhe: 5,2/3,2 cm, max. Breite LED-Strip: 2,0 cm, Abdeckung exkl.

GRAZIA 20

ZUBEHÖR

ABDECKUNGEN

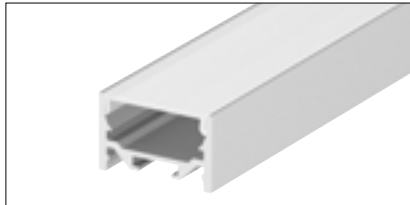

flach, matt t ansparent

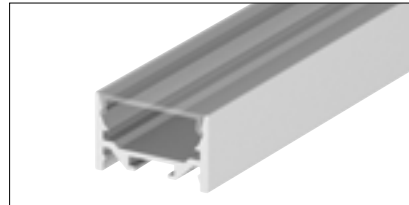

flach, matt t ansparent

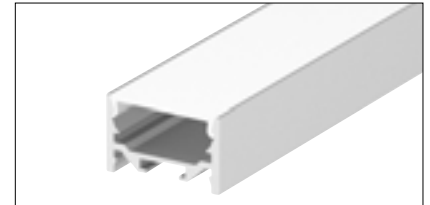

flach, milchi

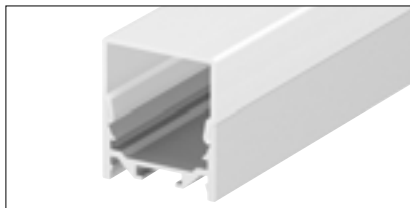

hoch, matt transparent

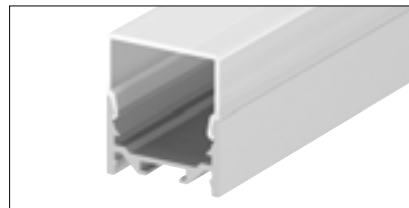

hoch, milchig

Länge	Farbe	Material	Art. Nr.
100 cm	flach, matt t ansparent	Kunststoff P	1000538
	flach, matt t ansparent	Kunststoff PMM	1000544
	flach, t ansparent	Kunststoff P	1000541
	flach, milchi	Kunststoff PMM	1000547
	hoch, matt transparent *	Kunststoff PMM	1000553
	hoch, milchig *	Kunststoff P	1000550
200 cm	flach, matt t ansparent	Kunststoff P	1000539
	flach, matt t ansparent	Kunststoff PMM	1000545
	flach, t ansparent	Kunststoff P	1000542
	flach, milchi	Kunststoff PMM	1000548
	hoch, matt transparent *	Kunststoff PMM	1000554
	hoch, milchig *	Kunststoff P	1000551
300 cm	flach, matt t ansparent	Kunststoff P	1000540
	flach, matt t ansparent	Kunststoff PMM	1000546
	flach, t ansparent	Kunststoff P	1000543
	flach, milchi	Kunststoff PMM	1000549
	hoch, matt transparent *	Kunststoff PMM	1000555
	hoch, milchig *	Kunststoff P	1000552

Kunststoff PMMA/PC

Profil-Abdeckungen aus PMMA sind besonders homogen

Profil-Abdeckungen aus PC sind bruchstark und eignen sich sehr gut für Anwendungen mit hohem Anspruch an die Widerstandsfähigkeit.

* Die hohen Abdeckungen sind nur für GRAZIA 20 Aufbauprofile geeignet, nicht für die Einbauprofile

LÄNGSVERBINDER

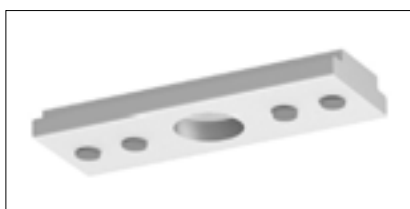

Beschreibung	Farbe	Maße	Art. Nr.
Längsverbinder	aluminium	L/B/H: 3,8/1,4/0,4 cm	1000571

Material: Aluminium, Verpackungseinheit: 2 Stück

GRAZIA 20

ZUBEHÖR

ENDKAPPEN FÜR AUFBAUPROFIL

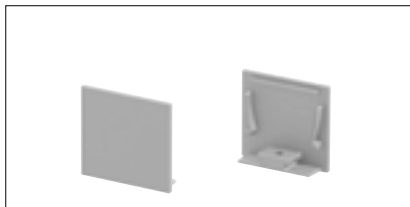

für Profil tandard, Abdeckung flac

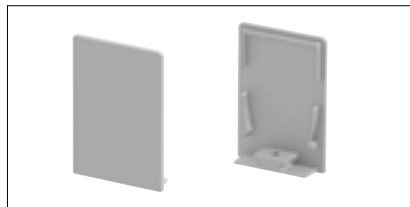

für Profil tandard, Abdeckung hoch

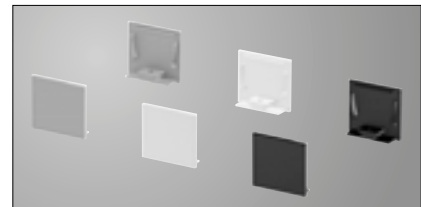

erhältliche Farbvarianten

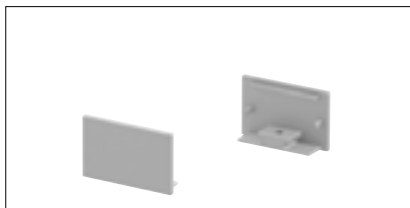

für Profil flac, Abdeckung fl

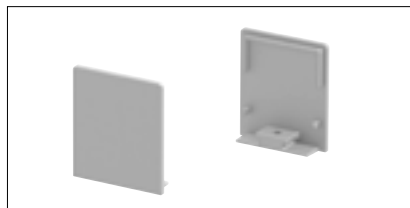

für Profil flac, Abdeckung hoch

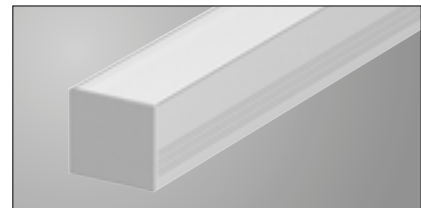

Profil mit montie ter Endkappe

Beschreibung	Farbe	sichtbare Tiefe	Art. Nr.
Profil tandard, Abdeckung flac	aluminium	0,25 cm	1000565
	weiß		1000566
	schwarz		1000567
Profil tandard, Abdeckung hoch	aluminium	0,25 cm	1000568
	weiß		1000569
	schwarz		1000570
Profil flac Abdeckung flac	aluminium	0,25 cm	1000559
	weiß		1000560
	schwarz		1000561
Profil flac Abdeckung hoch	aluminium	0,25 cm	1000562
	weiß		1000563
	schwarz		1000564

Material: Aluminium, Verpackungseinheit: 2 Stück

i Bitte beachten Sie, dass bei der Verwendung von Endkappen die sichtbare Tiefe von der Profillänge abg zogen werden muss, um die gewünschte Gesamtlänge zu erhalten.

sichtbare Tiefe Endkappen + Profillänge = Gesamtlänge

ENDKAPPEN FÜR EINBAUPROFIL



für Einbauprofil

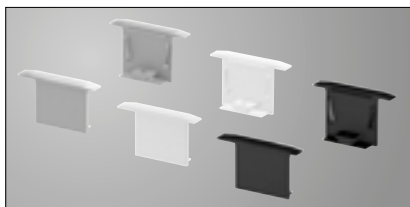

erhältliche Farbvarianten

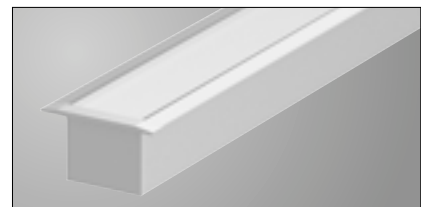

Profil mit montie ter Endkappe

Beschreibung	Farbe	sichtbare Tiefe	Art. Nr.
Endkappe für Einbauprofil	aluminium	0,085 cm	1000556
	weiß	0,085 cm	1000557
	schwarz	0,085 cm	1000558

Material: Aluminium, Verpackungseinheit: 2 Stück

i Bitte beachten Sie, dass bei der Verwendung von Endkappen die sichtbare Tiefe von der Profillänge abg zogen werden muss, um die gewünschte Gesamtlänge zu erhalten.

sichtbare Tiefe Endkappen + Profillänge = Gesamtlänge

PENDELABHÄNGUNG UND MONTAGECLIPS



Pendelabhangung (nur fur Aufbauprofile)



Montageclip, nicht sichtbar

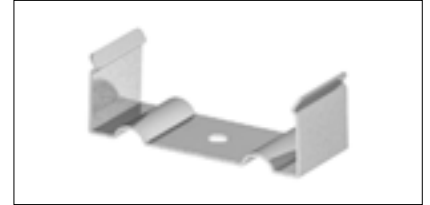

Montageclip, sichtbar (nur fur gerillte Aufbauprofile)

Beschreibung	Mae	Art. Nr.
Pendelabhangung *	Pendel-L: 200 cm	1000535
Montageclip, nicht sichtbar	L/B/H: 2,82/1,2/1,4 cm	1000536
Montageclip, sichtbar **	L/B/H: 3,65/6,2/1,5 cm	1000537

Material: Edelstahl, Verpackungseinheit: 2 Stuck

* Die Pendelabhangung ist nur fur die Aufbauprofile geeignet

** Der sichtbare Montageclip ist nur fur die Profile **GRAZIA 20 Standard, gerillt** und **GRAZIA 20 Flach, gerillt** geeignet.



H-PROFIL

2m

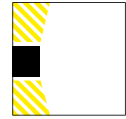



H-PROFIL 2m

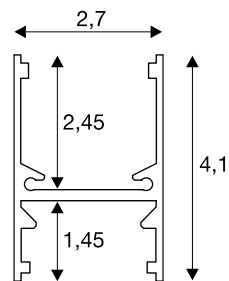
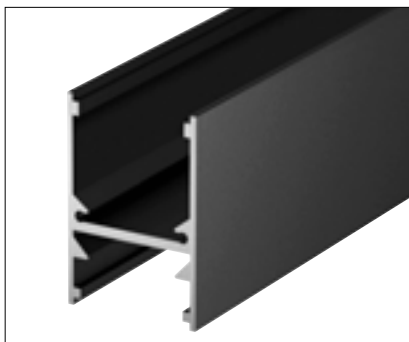

Länge	Farbe	Gewicht (kg)	Art. Nr.
200 cm	schwarz	1	1001814
	weiß		1001816
	aluminium		1001817

Material: Aluminium, Breite/Höhe: 2,7/4,1 cm, max. Breite LED-Strip: 1,6 cm, Abdeckung exkl.

H-PROFIL

2m – ZUBEHÖR

ABDECKUNG

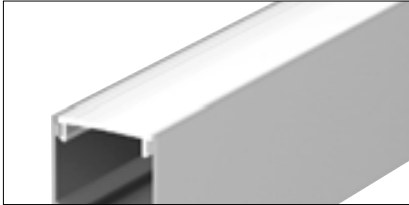

Abdeckung, milchig

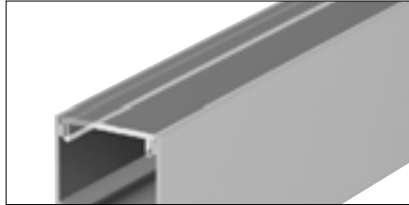

Abdeckung, transparent

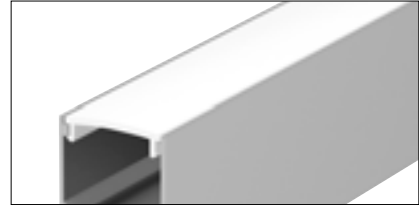

Abdeckung, satiniert

Länge	Farbe	Material	Art. Nr.
200 cm	milchig	Kunststoff P	1001813
	transparent	Kunststoff P	1001815
	transparent	Kunststoff PMM	214350
	matt transparent	Kunststoff PMM	214351

Verpackungseinheit: 1 Stück

ENDKAPPEN

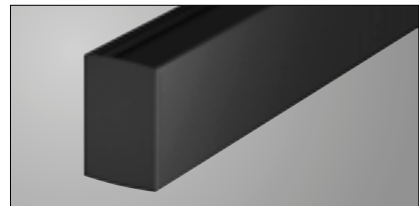

Beschreibung	Farbe	sichtbare Tiefe	Art. Nr.
Endkappen	schwarz	0,14 cm	1001807
	weiß	0,14 cm	1001808
	grau	0,14 cm	1001809

Material: Aluminium, Verpackungseinheit: 2 Stück

i Bitte beachten Sie, dass bei der Verwendung von Endkappen die sichtbare Tiefe von der Profillänge abg. zogen werden muss, um die gewünschte Gesamtlänge zu erhalten.

sichtbare Tiefe Endkappen + Profillänge = Gesamtlänge

VERBINDER

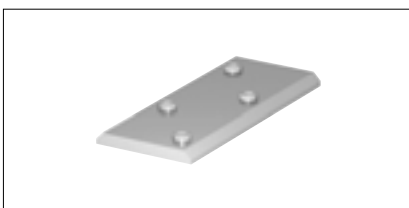

Beschreibung	Farbe	Maße	Art. Nr.
Verbinder	grau	L/B/H: 5,6/2,4/0,3 cm	1001806

Material: Aluminium

MONTAGEZUBEHÖR

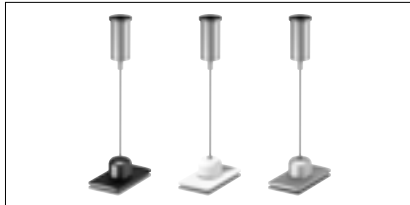

Pendelabhängung

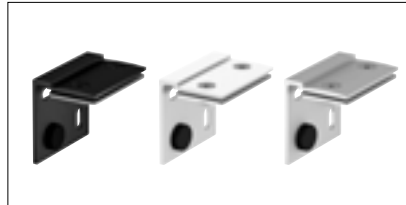

Wandhalterung



Adapter für Stromschiene

Beschreibung	Farbe	Material	Maße	Art. Nr.
Pendeabhängung, 2 Stk.	schwarz	Aluminium/Stahl	L/B/H: 4,4/2,4/2 cm Pendel-L: 200 cm	1001796
	weiß			1001797
	aluminium			1001798
Wandhalterung, 2 Stk.	schwarz	Aluminium/Kunststoff	L/B/H: 4,4/3,2/4 cm	1001802
	weiß			1002236
	aluminium			1002237
Adapter für SLV D-TRACK (2.Ph.) Stromschiene, 5 Stk.	silber	Stahl	L/B/H: 2/2,2/0,3 cm	1001810

ZUGENTLASTUNG

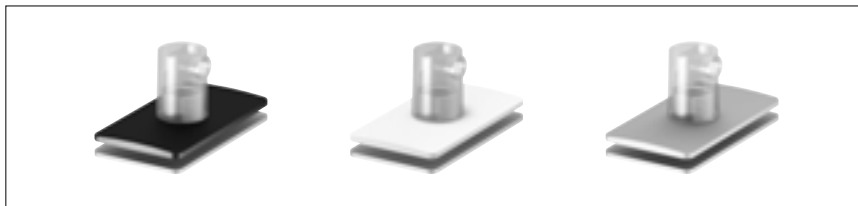

Beschreibung	Farbe	Maße	Art. Nr.
Zugentlastung	schwarz	L/B/H: 4,4/2,4/2,6 cm	1001799
	weiß		1001800
	aluminium		1001801

Material: Aluminium/Stahl, Kabeldurchmesser max. 6,5 mm, Verpackungseinheit: 1 Stück

ANSCHLUSSBOX



Beschreibung	Farbe	Maße	Art. Nr.
Anschlussbox	schwarz	L/B/H: 37,6/6,6/4,7 cm	1001803
	weiß		1001804
	grau		1001805

Material: Aluminium/Stahl, Die Deckenrosette ist für den Einbau von Betriebsgeräten und Kabeln vorbereitet. Betriebsgeräte und Kabel sind separat erhältlich. Verfügbarer Bauraum für Treiber max. 6,2 x 25 x 4 cm. Verpackungseinheit: 1 Stück

KENAI

AUFBAUPROFIL

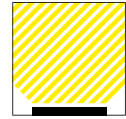

KENAI AUFBAUPROFIL

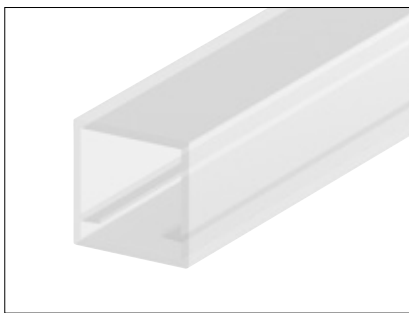

transparent

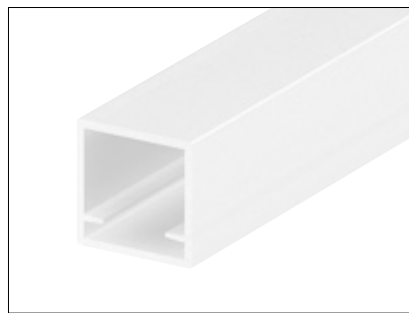

satiert

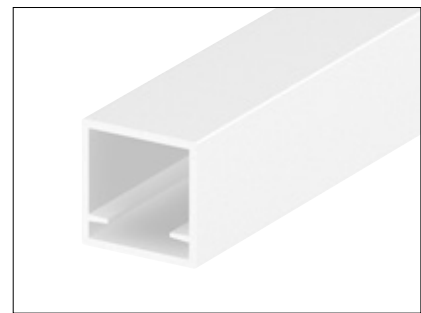

milchig

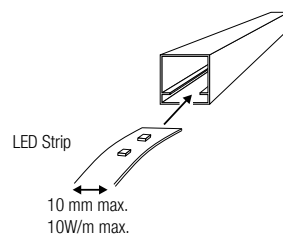
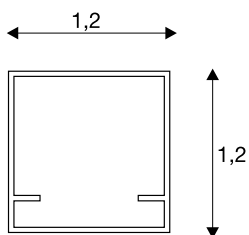

Farbe	Material	Länge (cm)	Breite (cm)	Höhe (cm)	Gewicht (kg)	Art. Nr.
transparent	PMMA	200	1,2	1,2	0,1	214100
matt transparent						214101
milchig						214102

Max. Breite LED-Strip: 1,0 cm, Abdeckung inkl., maximale Strip-Leistung 10W/m.

KENAI

AUFBAUPROFIL – ZUBEHÖR

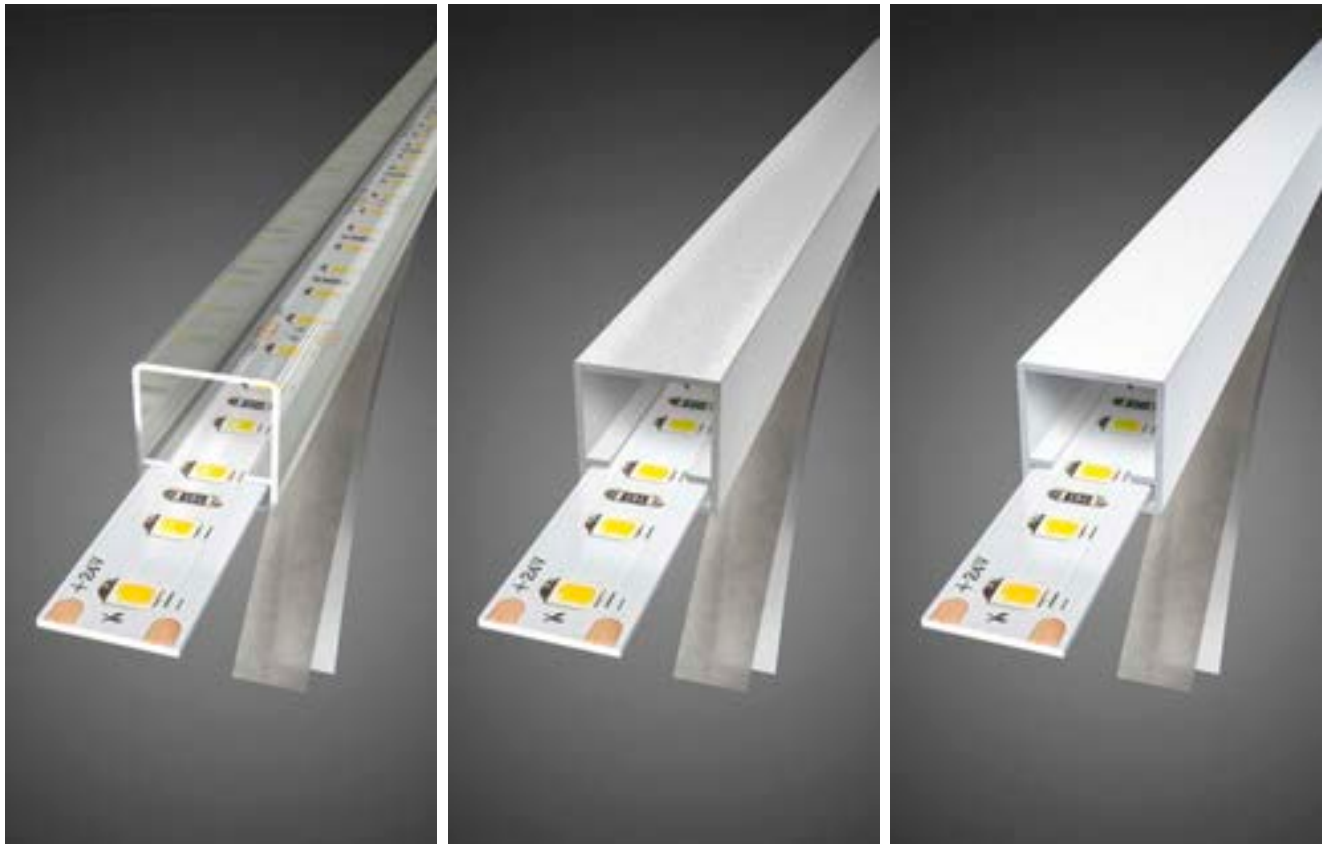

DOPPELSEITIGES KLEBEBAND



Beschreibung	Farbe	Material	Maße	Art. Nr.
Doppelseitiges Klebeband	transparent	Kunststoff	L/B: 300/0,9 cm	220000

GLENOS

LINEAR-PROFIL 1107

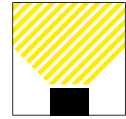

GLENOS Linear-Profil 110

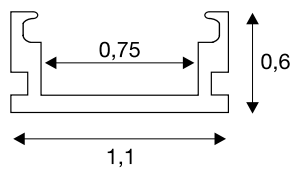

Länge	Farbe	Gewicht (kg)	Art. Nr.
200 cm	matt schwarz	0,14	213950
	matt weiß		213951
	aluminium		213954

Material: Aluminium, Breite/Höhe: 1,1/0,6 cm, max. Breite LED-Strip: 0,75 cm, Abdeckung exkl.

GLENOS

LINEAR-PROFIL 1107 – ZUBEHÖR

ABDECKUNG



Abdeckung, weiß

Länge	Farbe	Material	Art. Nr.
200 cm	weiß	Kunststoff P	213962

Kunststoff PC

Profil-Abdeckungen aus PC sind bruchsicher und eignen sich sehr gut für Anwendungen mit hohem Anspruch an die Widerstandsfähigkeit.

ENDKAPPEN

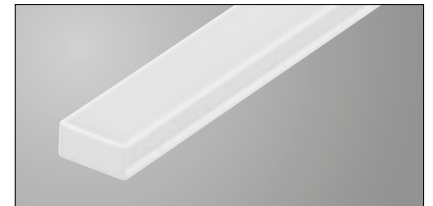
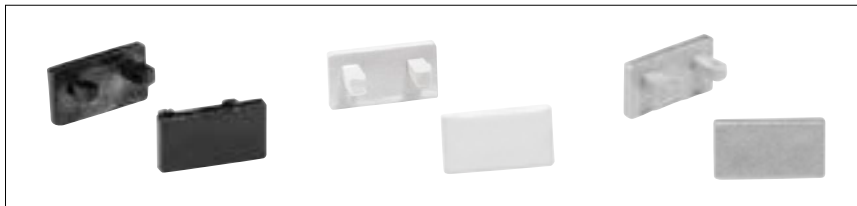

Beschreibung	Farbe	sichtbare Tiefe	Art. Nr.
Endkappen	matt schwarz	0,015 cm	213970
	matt weiß	0,015 cm	213971
	grau	0,015 cm	213974

Material: Kunststoff, erpackungseinheit: 2 Stück

i Bitte beachten Sie, dass bei der Verwendung von Endkappen die sichtbare Tiefe von der Profillänge abgezogen werden muss, um die gewünschte Gesamtlänge zu erhalten.

sichtbare Tiefe Endkappen + Profillänge = Gesamtlänge

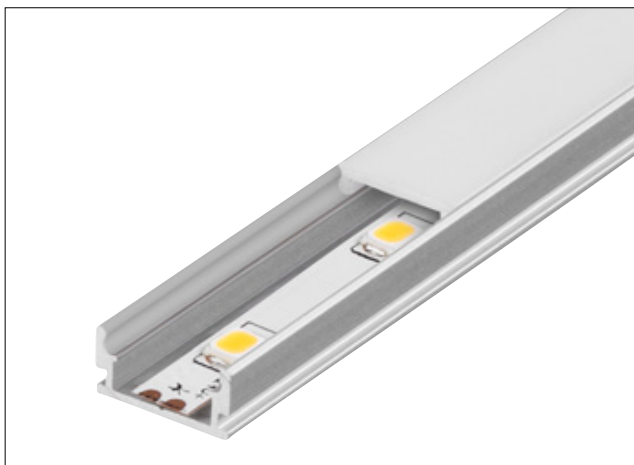

GLENOS Linear-Profil 1107 mit eingeklebtem LED-Strip und Abdeckung

GLENOS

LINEAR-EINBAU-PROFIL 2508

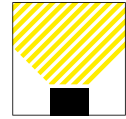

GLENOS

LINEAR-EINBAU-PROFIL 2508

GLENOS Linear-Einbau-Profil 250

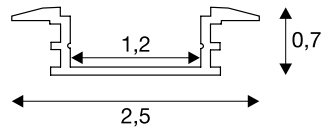

Länge	Farbe	Gewicht (kg)	Art. Nr.
200 cm	aluminium	0,58	213862

Material: Aluminium, Breite/Höhe: 2,5/0,7 cm, max. Breite LED-Strip: 1,2 cm, Abdeckung exkl.

ZUBEHÖR

ABDECKUNG UND ENDKAPPEN



Abdeckung, weiß

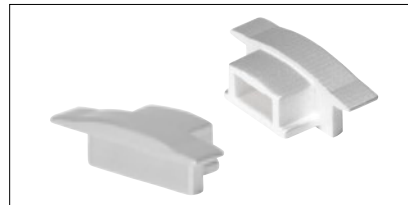

Endkappen

Beschreibung	Farbe	Material	Maße	Art. Nr.
Abdeckung	weiß	Kunststoff P	L/B/H: 200/1,5/0,5 cm	213822
Endkappen, 2 Stk.	grau	Kunststoff	L/B/H: 2,4/0,5/0,8 cm sichtbare Tiefe: 0,05 cm	213874



Bitte beachten Sie, dass bei der Verwendung von Endkappen die sichtbare Tiefe von der Profillänge abg. zogen werden muss, um die gewünschte Gesamtlänge zu erhalten.

sichtbare Tiefe Endkappen + Profillänge = Gesamtläng

GLENOS

ECK-PROFIL 2720

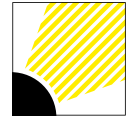

STANDARD



gerillt

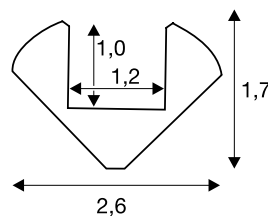

Länge	Farbe	Gewicht (kg)	Art. Nr.
200 cm	matt weiß aluminium	0,54	213911 213914

Material: Aluminium, Breite/Höhe: 2,6/1,7 cm, max. Breite LED-Strip: 1,0 cm, Abdeckung exkl.

GLENOS

ECK-PROFIL 2720 – ZUBEHÖR

ABDECKUNG

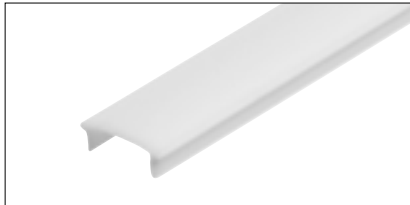

Abdeckung, weiß

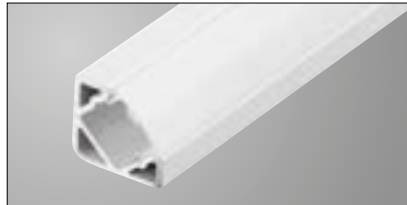

GLENOS Eck-Profil 2720 mit Abdeckun

Länge	Beschreibung	Breite (cm)	Höhe (cm)	Art. Nr.
100 cm	milchig	1,5	0,5	213821
200 cm				213822

Material: Kunststoff PC, erpackungseinheit: 1 Stück

ENDKAPPEN

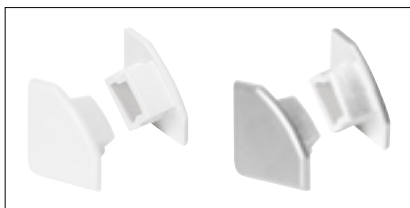

Beschreibung	Farbe	sichtbare Tiefe	Art. Nr.
Endkappen	matt weiß	0,2 cm	213931
	grau	0,2 cm	213934

Material: Kunststoff, erpackungseinheit: 2 Stück



Bitte beachten Sie, dass bei der Verwendung von Endkappen die sichtbare Tiefe von der Profillänge abg. zogen werden muss, um die gewünschte Gesamtlänge zu erhalten.

sichtbare Tiefe Endkappen + Profillänge = Gesamtläng

MONTAGECLIP



Beschreibung	Maße	Art. Nr.
Montageclip	L/B/H: 2,4/2,1/2 cm	213939

Material: Edelstahl, Verpackungseinheit: 2 Stück

GLENOS

PROFI-PROFIL 3030

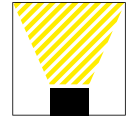

GLENOS Profi- rofil 303

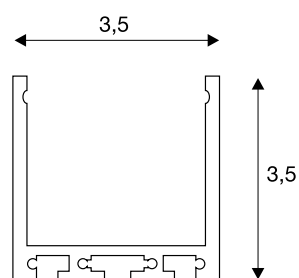

Länge	Farbe	Gewicht (kg)	Art. Nr.
200 cm	matt schwarz	1,4	213620
	matt weiß		213621
	grau		213624
300 cm	matt schwarz	2,1	213630
	matt weiß		213631
	grau		213634

Material: Aluminium, Breite/Höhe: 3,5/3,5 cm, max. Breite LED-Strip: 3 cm, Abdeckung exkl.

GLENOS

PROFI-PROFIL 3030 – ZUBEHÖR

ABDECKUNG



Länge	Beschreibung	Breite (cm)	Höhe (cm)	Art. Nr.
200 cm	Polycarbonat (PC)	3,3	0,5	213642
300 cm				213643

Material: Kunststoff PC, Verpackungseinheit: 1 Stück

ENDKAPPEN



Beschreibung	Farbe	sichtbare Tiefe	Art. Nr.
Endkappen	matt schwarz	0,2 cm	213650
	matt weiß	0,2 cm	213651
	grau	0,2 cm	213654

Material: Zink, Verpackungseinheit: 2 Stück



Bitte beachten Sie, dass bei der Verwendung von Endkappen die sichtbare Tiefe von der Profillänge abgezogen werden muss, um die gewünschte Gesamtlänge zu erhalten.

sichtbare Tiefe Endkappen + Profillänge = Gesamtlänge

ABHÄNGESET

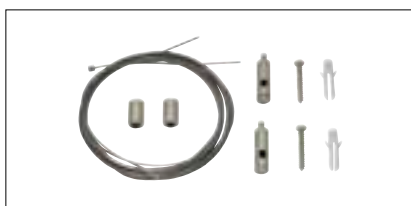

Beschreibung	Farbe	Maße	Art. Nr.
Abhängeset	chrom	Pendel-L: 250 cm	213488

Material: Stahl, Verpackungseinheit: 1 Stück

GLENOS

PROFI-PROFIL 4970

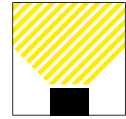

GLENOS Profi- rofil 497

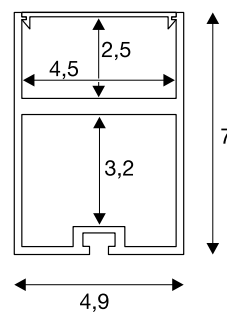

Länge	Farbe	Gewicht (kg)	Art. Nr.
200 cm	matt schwarz	3	213470
	weiß		213471
	aluminium		213474

Material: Aluminium/Kunststoff PC, B eite/Höhe: 4,9/7 cm, max. Breite LED-Strip: 3,7 cm, Abdeckung inkl.

GLENOS

PROFI-PROFIL 4970 – ZUBEHÖR

ENDKAPPEN

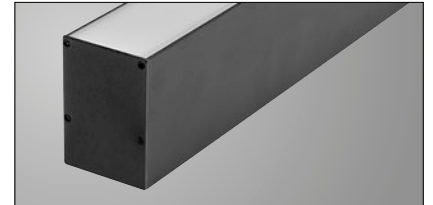

Beschreibung	Farbe	sichtbare Tiefe	Art. Nr.
Endkappen	matt schwarz	0,8 cm	213480
	weiß	0,8 cm	213481
	aluminium	0,8 cm	213484

Material: Zink, Verpackungseinheit: 2 Stück



Bitte beachten Sie, dass bei der Verwendung von Endkappen die sichtbare Tiefe von der Profillänge abgezogen werden muss, um die gewünschte Gesamtlänge zu erhalten. **sichtbare Tiefe Endkappen + Profillänge = Gesamtlänge**

VERBINDER



Beschreibung	Farbe	Maße	Art. Nr.
Verbinder für Aluprofil verz	grau	L/B/H: 10/0,95/0,3 cm	213489

Material: Stahl, Verpackungseinheit: 1 Stück

ABHÄNGESET

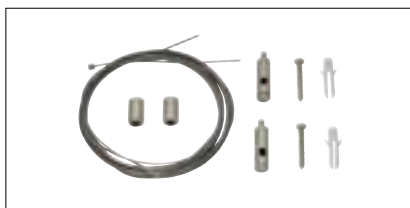

Beschreibung	Farbe	Maße	Art. Nr.
Abhängeset	chrom	Pendel-L: 250 cm	213488

Material: Stahl, Verpackungseinheit: 1 Stück

NETZTEIL



Beschreibung	Farbe	Maße	Art. Nr.
LED Netzteil 24V 60W	weiß	L/B/H: 28/3/2,2 cm	977399

Material: Stahl/Kunststoff, erpackungseinheit: 1 Stück

GLENOS

PROFI-EINBAU-PROFIL 8832

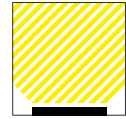

GLENOS Profi-Einbau- rofil 883

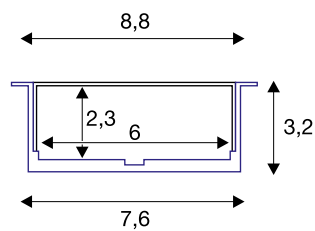
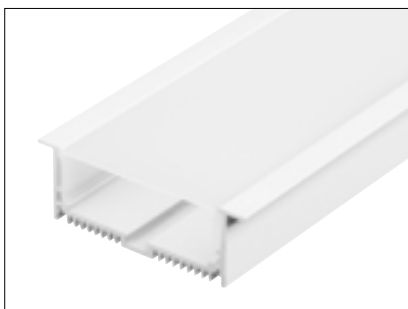

Länge	Farbe	Gewicht (kg)	Art. Nr.
200 cm	weiß aluminium	2,3	213511 213514

Material: Aluminium/Polycarbonat (PC), Breite/Höhe: 8,8/3,2 cm, max. Breite LED-Strip: 2 cm, Materialstärke Einbaufäche: max. 24 mm, Abdeckung inkl Um Kühlung zu gewährleisten, Strip nicht in die Mitte kleben.

GLENOS

PROFI-EINBAU-PROFIL 8832 – ZUBEHÖR

ENDKAPPEN

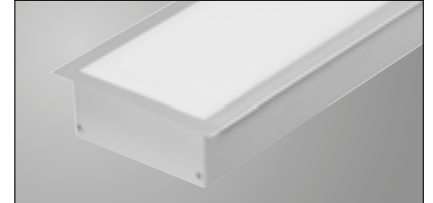
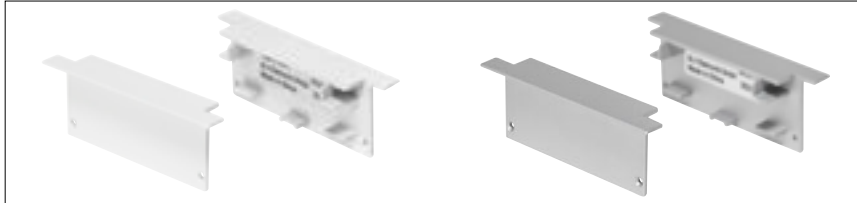

Beschreibung	Farbe	sichtbare Tiefe	Art. Nr.
Endkappen	weiß	1,80 cm	213521
	aluminium	1,80 cm	213524

Material: Zink, Verpackungseinheit: 2 Stück



Bitte beachten Sie, dass bei der Verwendung von Endkappen die sichtbare Tiefe von der Profillänge abgezogen werden muss, um die gewünschte Gesamtlänge zu erhalten.

sichtbare Tiefe Endkappen + Profillänge = Gesamtlänge

MONTAGEBÜGEL

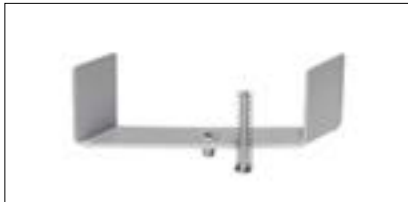

Beschreibung	Maße	Art. Nr.
Montagebügel	L/B/H: 11,2/2/3 cm	213529

Material: Aluminium, Verpackungseinheit: 2 Stück

GLENOS

PROFI-PROFIL 2020

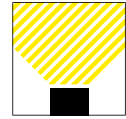

GLENOS Profi- rofil 202

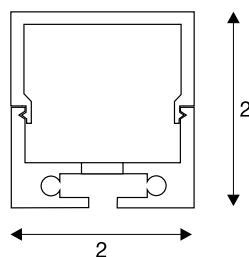

Länge	Farbe	Gewicht (kg)	Art. Nr.
200 cm	schwarz	0,56	213440
	weiß		213441
	aluminium/weiß		213444

Material: Aluminium/Polycarbonat, Breite/Höhe: 2,0/2,0 cm, max. Breite LED-Strip: 1,6 cm, Abdeckung inkl., Diffuser inkl

GLENOS

PROFI-PROFIL 2020 – ZUBEHÖR



ENDKAPPEN UND LÄNGSVERBINDER

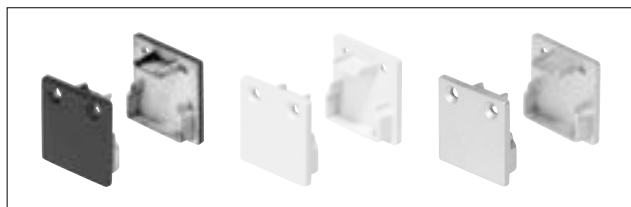

Endkappen



Längsverbinder

Beschreibung	Farbe	Material	Maße	Art. Nr.
Endkappen, 2 Stk.	schwarz	Zink	L/B/H: 2/0,2/2 cm sichtbare Tiefe: 0,2 cm	213450
	weiß			213451
	grau			213454
Längsverbinder, 1 Stk.	aluminium	Aluminium	L/B/H: 20/1,3/0,3 cm	213459



Bitte beachten Sie, dass bei der Verwendung von Endkappen die sichtbare Tiefe von der Profillänge abg. zogen werden muss, um die gewünschte Gesamtlänge zu erhalten.

sichtbare Tiefe Endkappen + Profillänge = Gesamtlänge

BEEINDRUCKEN AUF GANZER LINIE.

LED-STRIPS UND LICHTBALKEN
FÜR EINE BESONDERE ATMOSPHERE.

Sie wollen Abwechslung ins Spiel bringen? LED-Strips und Lichtbalken sind moderne und außergewöhnliche Gestaltungselemente, die Räumen eine besondere Atmosphäre verleihen. Und auch als Wegweiser machen die länglichen Leuchten in vielen Farbvarianten eine gute Figur.

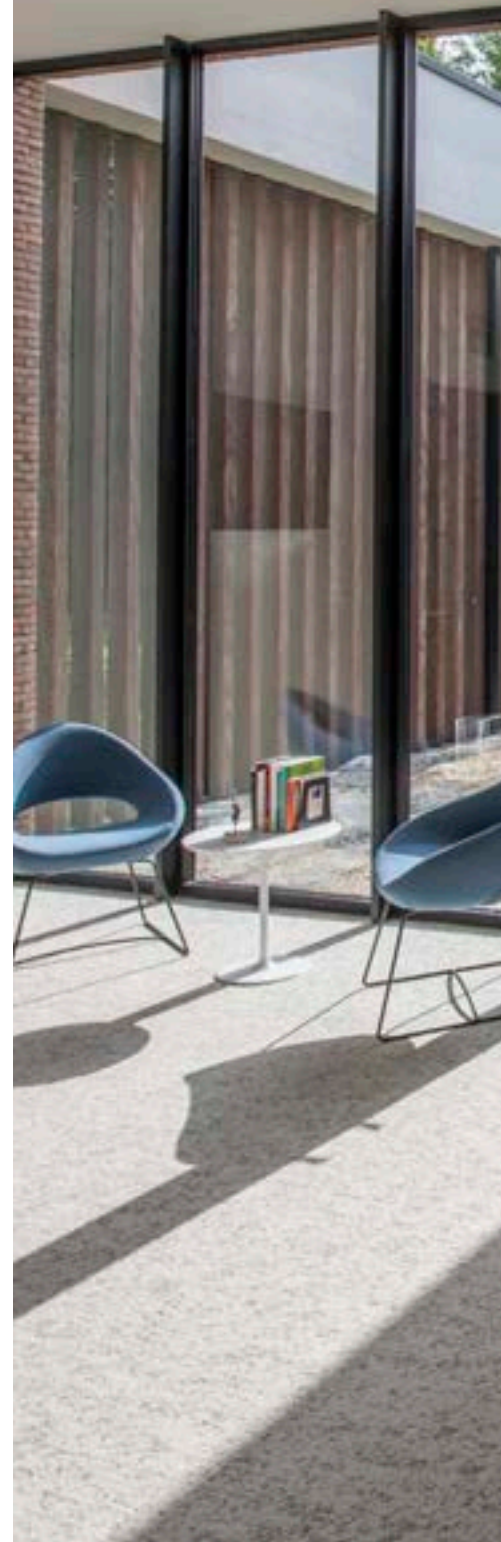



213511 + 1002989 774 + 801



PROFIL-STRIP STANDARD

ÜBERSICHT

Detailinformationen zu den Produkten finden Sie auf der angegebenen Katalogseite.



		Profil- strip Standard			
Lumen pro Meter		850lm/m	1000lm/m	1200lm/m	2000lm/m
LEDs pro Meter		120 LEDs/m		180 LEDs/m	
Farbwiedergabeindex		CRI>80			
					
Farbtemperatur	2700K	552732	552742	552752	552762
Farbtemperatur	3000K	552733	552743	552753	552763
Farbtemperatur	4000K	552734	552744	552754	552764
Katalogseite		783	783	783	783
passende LED-Profil	LED-Strips				
	Einbau	✓	✓	✓	—
GRAZIA 10	Flach	✓	✓	✓	✓
	Standard	✓	✓	✓	✓
	Einbau	✓	✓	✓	✓
GRAZIA 20	Flach, glatt	✓	✓	✓	✓
	Flach, gerillt	✓	✓	✓	✓
	Standard, glatt	✓	✓	✓	✓
	Standard, gerillt	✓	✓	✓	✓
	Standard, gerillt	✓	✓	✓	✓



Passende Profile und Komponenten finden Sie ab Seite 746 und das passende Zubehör (Netzteile, Treiber, etc.) ab Seite 842



Profil- trip Standard

750lm/m	1600lm/m	1600lm/m
180 LEDs/m		120 LEDs/m
CRI>80		CRI 90
		
552772	552782	552792
552773	552783	552793
552774	552784	552794
782	782/783	782/783
✓	—	✓
✓	—	✓
✓	✓	✓
✓	—	✓
✓	✓	✓
✓	✓	✓
✓	✓	✓
✓	✓	✓



PROFIL-STRIP STANDARD

24V



PROFIL-STRIP STANDARD, 24V



180 LEDs pro m
Breite/Höhe: 1/0,2 cm
LED-Abstand: 0,55 cm
Trennbar alle 3,4 cm
minimaler Biegeradius: 3,8 cm

3 m, CRI>80

Farbtemperatur	Lichtstrom (lm)	Leistung (W)	Farbwiedergabeindex (CRI)	Farbkonsistenz	Länge (cm)	Energieeffizienzklasse	Art. Nr.
2700K	2250	25	>80	3SDCM	300	A+	552772
	4800	55				A	552782
3000K	2250	25				A+	552773
	4800	50				A+	552783
4000K	2250	25				A+	552774
	4800	45				A+	552784

Um gleichbleibende Lichtleistung ab einer Länge von 1,5 m zu erhalten, empfehlen wir die Strips beidseitig einzuspeisen. Ab einer Länge von 3 m muss neu eingespeist werden.

PROFIL-STRIP STANDARD, 24V



120 LEDs pro m
 Breite/Höhe: 1/0,2 cm
 LED-Abstand: 0,8 cm
 Trennbar alle 5 cm
 minimaler Biegeradius: 3,8 cm

3 m, CRI>80

Farbtemperatur	Lichtstrom (lm)	Leistung (W)	Farbwiedergabeindex (CRI)	Farbkonsistenz	Länge (cm)	Energieeffizienzklasse	Art. Nr.
2700K	2550	30	>80	3SDCM	300	A	552732
	3000	40				A	552742
	3600	45				A	552752
	6000	80				A	552762
3000K	2550	25				A+	552733
	3000	35				A	552743
	3600	40				A	552753
	6300	75				A	552763
4000K	2550	25				A+	552734
	3000	30				A+	552744
	3600	35				A+	552754
	6600	70				A	552764

Ab einer Länge von 2,5 m muss beidseitig eingespeist werden. Ab einer Länge von 5 m muss neu eingespeist werden.

3 m, CRI>90

Farbtemperatur	Lichtstrom (lm)	Leistung (W)	Farbwiedergabeindex (CRI)	Farbkonsistenz	Länge (cm)	Energieeffizienzklasse	Art. Nr.
2700K	4800	65	>90	3SDCM	300	A	552792
3000K							552793
4000K							552794

Um gleichbleibende Lichtleistung ab einer Länge von 1,5 m zu erhalten, empfehlen wir die Strips beidseitig einzuspeisen. Ab einer Länge von 3 m muss neu eingespeist werden.

ZUBEHÖR PROFIL-STRIP STANDARD, 24V



Einspeiser, 50 cm Kabel



Direktverbinder

Variante	Strombelastung max.	Material	Länge (cm)	Breite (cm)	Höhe (cm)	Art. Nr.
<input type="checkbox"/> Einspeiser, 1 Stk.	3A	Kunststoff	2	1	0,4	1002141
<input type="checkbox"/> Direktverbinder, 1 Stk.	3A	Kunststoff	2,3	1	0,4	1002142



Um die Wärmeableitung zu gewährleisten, müssen die LED-Strips in ein Aluminiumprofil geklebt werden. Rückseite der LED-Strips mit Klebeband.

PROFIL-STRIP GRAND

ÜBERSICHT

Detailinformationen zu den Produkten finden Sie auf der angegebenen Katalogseite.

		Profil- strip Grand				
Lumen pro Meter		1600lm/m	2000lm/m	3000lm/m	3700lm/m	2600lm/m
LEDs pro Meter		240 LEDs/m				
Farbwiedergabeindex		CRI>80				CRI 90
						
Farbtemperatur	2700K	552802	552812	552822	552832	552852
Farbtemperatur	3000K	552803	552813	552823	552833	552853
Farbtemperatur	4000K	552804	552814	552824	552834	552854
Katalogseite		787	787	787	787	787
passende LED-Profil	LED-Strips					
	Einbau	—	—	—	—	—
GRAZIA 10	Flach	—	—	—	—	—
	Standard	—	—	—	—	—
	Einbau	✓	✓	✓	—	✓
GRAZIA 20	Flach, glatt	✓	✓	✓	✓	✓
	Flach, gerillt	✓	✓	✓	✓	✓
	Standard, glatt	✓	✓	✓	✓	✓
	Standard, gerillt	✓	✓	✓	✓	✓



Passende Profile und Komponenten finden Sie ab Seite 746 und das passende Zubehör (Netzteile, Treiber, etc.) ab Seite 842



PROFIL-STRIP GRAND

24V

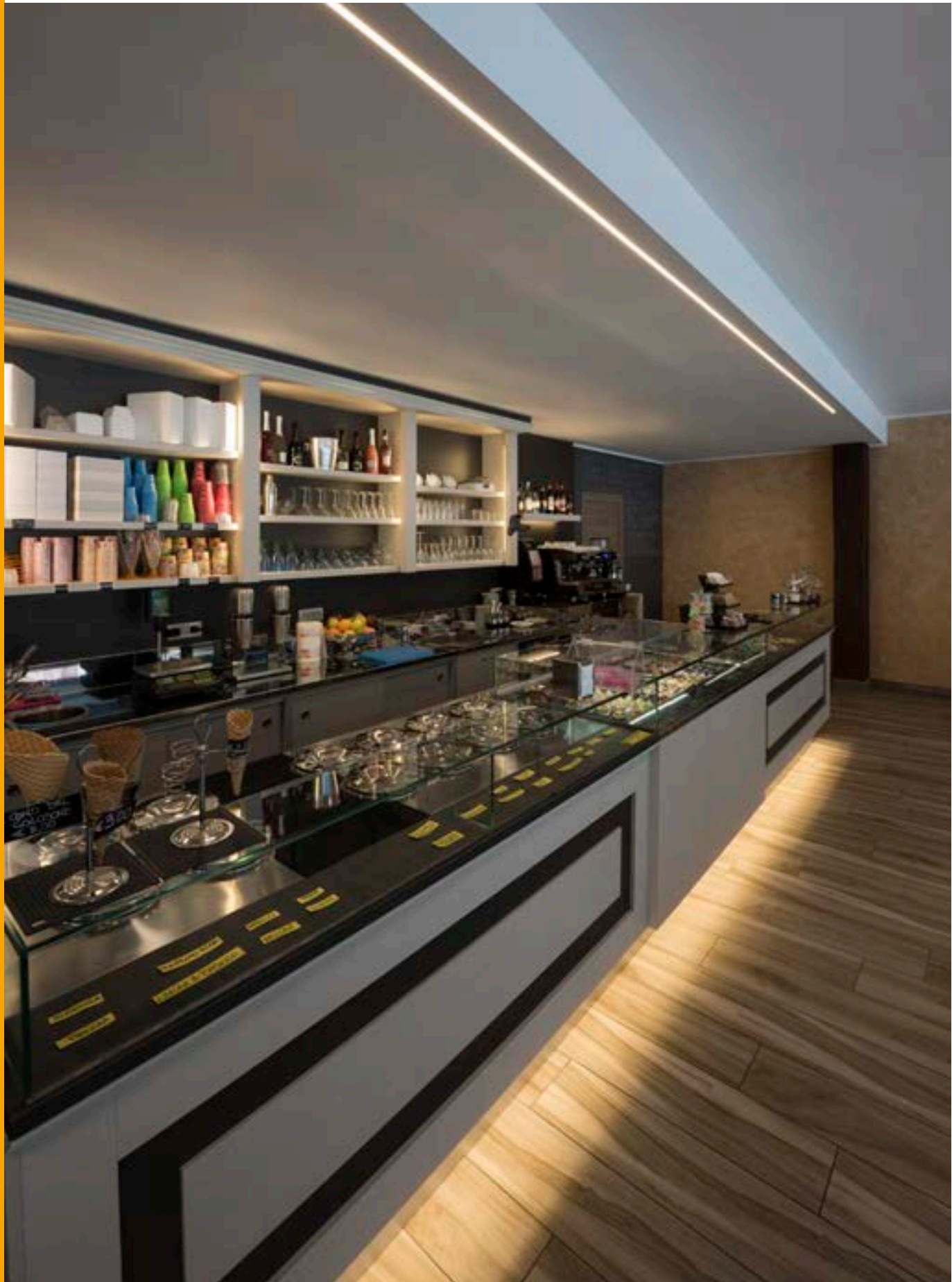

PROFIL-STRIP GRAND, 24V



240 LEDs pro m
 Breite/Höhe: 2/0,2 cm
 LED-Abstand: 0,4 cm
 Trennbar alle 2,5 cm
 minimaler Biegeradius: 3,8 cm

2 m, CRI>80

Farbtemperatur	Lichtstrom (lm)	Leistung (W)	Farbwiedergabeindex (CRI)	Farbkonsistenz	Länge (cm)	Energieeffizienzklasse	Art. Nr.
2700K	7400	92	>80	4SDCM	200	A+	552832
3000K		102					552833
4000K		84					552834

Um gleichbleibende Lichtleistung ab einer Länge von 1 m zu erhalten, empfehlen wir die Strips beidseitig einzuspeisen. Ab einer Länge von 2 m muss neu eingespeist werden.

3 m, CRI>80

Farbtemperatur	Lichtstrom (lm)	Leistung (W)	Farbwiedergabeindex (CRI)	Farbkonsistenz	Länge (cm)	Energieeffizienzklasse	Art. Nr.
2700K	4800	52	>80	4SDCM	300	A+	552802
	6000	68					552812
	9000	102					552822
3000K	4800	52				A+	552803
	6000	68					552813
	9000	105					552823
4000K	4800	48				A+	552804
	6000	62					552814
	9000	96					552824

Um gleichbleibende Lichtleistung ab einer Länge von 1,5 m zu erhalten, empfehlen wir die Strips beidseitig einzuspeisen. Ab einer Länge von 3 m muss neu eingespeist werden.

3 m, CRI>90

Farbtemperatur	Lichtstrom (lm)	Leistung (W)	Farbwiedergabeindex (CRI)	Farbkonsistenz	Länge (cm)	Energieeffizienzklasse	Art. Nr.
2700K	7800	114	>90	6SDCM	300	A	552852
3000K		106					552853
4000K		100					552854

Ab einer Länge von 1,5 m muss beidseitig eingespeist werden. Ab einer Länge von 3 m muss neu eingespeist werden.

ZUBEHÖR PROFIL-STRIP GRAND, 24V



Einspeiser, 50 cm Kabel



Direktverbinder

Variante	Strombelastung max.	Material	Länge (cm)	Breite (cm)	Höhe (cm)	Art. Nr.
<input type="checkbox"/> Einspeiser, 1 Stk.	3A	Kunststoff	2	2	0,4	1002143
<input type="checkbox"/> Direktverbinder, 1 Stk.	3A	Kunststoff	2,3	2	0,4	1002144







Um die Wärmeableitung zu gewährleisten, müssen die LED-Strips in ein Aluminiumprofil geklebt werden. Rückseite der LED-Strips mit Klebeband.



WEITERE LED-STRIPS

ÜBERSICHT

Detailinformationen zu den Produkten finden Sie auf der angegebenen Katalogseite.

	PROFIL-STRIP X-SLIM				PROFIL-STRIP SELECT
	-	300lm/m	400lm/m	500lm/m	800lm/m
Lumen pro Meter	-	300lm/m	400lm/m	500lm/m	800lm/m
LEDs pro Meter	60 LEDs/m	120 LEDs/m			
Farbwiedergabeindex	-	CRI>80			
LED-Strip Breite	0,5 cm				0,8 cm
					
Farbtemperatur	2700K	552702	552712	552722	552692
Farbtemperatur	3000K	552703	552713	552723	552693
Farbtemperatur	4000K	552704	552714	552724	552694
Farbtemperatur	Blau	552727			
Katalogseite	793	793	793	793	795

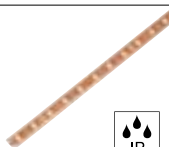
FLEX ROLL

Lumen pro Meter	300lm/m
LEDs pro Meter	60 LEDs/m
Farbwiedergabeindex	CRI>80
LED-Strip Breite	
	
	
Farbtemperatur	2700K
Farbtemperatur	3000K
Farbtemperatur	4000K
Katalogseite	812













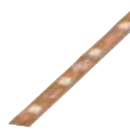

Passende Profile und Komponenten finden Sie ab Seite 746 und das passende Zubehör (Netzteile, Treiber, etc.) ab Seite 842



		LED-STRIP		
Lumen pro Meter		925lm/m	1000lm/m	1200lm/m
LEDs pro Meter		60 LEDs/m		
Farbwiedergabeindex		CRI>80		
LED-Strip Breite		1 cm		
				
Farbtemperatur	2700K	552442		
Farbtemperatur	3000K		552443	
Farbtemperatur	5000K			552445
Katalogseite		798	798	798

		FLEXLED		
Lumen pro Meter		500lm/m	510lm/m	570lm/m
LEDs pro Meter		60 LEDs/m		
Farbwiedergabeindex		CRI>80		
LED-Strip Breite		0,8 cm		
				
Farbtemperatur	2700K	552422		
Farbtemperatur	3000K		552423	
Farbtemperatur	5000K			552425
Katalogseite		797	797	797





		FLEXLED ROLL			FLEXLED		
Lumen pro Meter		370lm/m			385lm/m	395lm/m	470lm/m
LEDs pro Meter		60 LEDs/m			60 LEDs/m		
Farbwiedergabeindex		CRI>80			CRI>80		
LED-Strip Breite		1 cm			0,6 cm		
							
Farbtemperatur	2700K	552120			552522		
Farbtemperatur	3000K		552122			552523	
Farbtemperatur	5000K			552121			552525
Katalogseite		799	799	799	805	805	805

		FLEXLED STRIP					
Lumen pro Meter		17600lm/m	19200lm/m	21600lm/m	1050lm/m	1200lm/m	1280lm/m
LEDs pro Meter		48 LEDs/m			120 LEDs/m		
Farbwiedergabeindex		CRI>90			CRI>80		
LED-Strip Breite		1 cm					
							
Farbtemperatur	2200K	1002996			1001972		
Farbtemperatur	2700K		1002997			1002026	
Farbtemperatur	3000K		1002998			1002027	
Farbtemperatur	4000K			1002999			1002028
Katalogseite		801	801	801	800	800	800

		FLEXSTRIP LED HIGH LUMEN		
Lumen pro Meter		1900lm/m	1940lm/m	2150lm/m
LEDs pro Meter		120 LEDs/m		
Farbwiedergabeindex		CRI>80		
LED-Strip Breite		1 cm		
				
Farbtemperatur	2700K	552482		
Farbtemperatur	3000K		552483	
Farbtemperatur	5000K			552485
Katalogseite		803	803	803



KELVIN CONTROL-STRIP		
Lumen pro Meter	627-1307lm/m	1174-2410lm/m
LEDs pro Meter	240lm/m	
Farbwiedergabeindex	CRI>80	
LED-Strip Breite	1 cm	
		
Farbtemperatur	2700-6500K	552863
Katalogseite	807	807

	FLEXSTRIP LED RGB	FLEXLED ROLL RGB	FLEXLED ROLL MULTICOLOUR RGBW
Farbtemperatur	RGB	RGB	RGBW
LED-Strip Breite	1 cm	2 cm	1,2 cm
			
LEDs pro Meter	48 LEDs/m		
LEDs pro Meter	60 LEDs/m	552649	552453
LEDs pro Meter	120 LEDs/m		1001971
Katalogseite	809	811	810



 Passende Profile und Komponenten finden Sie ab Seite 746 und das passende Zubehör (Netzteile, Treiber, etc.) ab Seite 842

PROFIL-STRIP X-SLIM

24V



PROFIL-STRIP X-SLIM, 24V



120 LEDs pro m
Breite/Höhe: 0,5/0,2 cm
LED-Abstand: 0,8 cm
Trennbar alle 5 cm
minimaler Biegeradius: 3,8 cm
Extra-schmaler LED-Strip

3 m, CRI>80

Farbtemperatur	Lichtstrom (lm)	Leistung (W)	Farbwiedergabeindex (CRI)	Farbkonsistenz	Länge (cm)	Energieeffizienzklasse	Art. Nr.
2700K	900	8	>80	3SDCM	300	A+	552702
	1200	12				A+	552712
	1500	15				A+	552722
3000K	900	6				A++	552703
	1200	12				A+	552713
	1500	15				A+	552723
4000K	900	7				A++	552704
	1200	12				A+	552714
	1500	15				A+	552724

Um gleichbleibende Lichtleistung ab einer Länge von 1,5 m zu erhalten, empfehlen wir die Strips beidseitig einzuspeisen.
 Ab einer Länge von 3 m muss neu eingespeist werden.

PROFIL-STRIP X-SLIM, 24V



60 LEDs pro m
Breite/Höhe: 0,5/0,3 cm
LED-Abstand: 0,8 cm
Trennbar alle 10 cm
minimaler Biegeradius: 3,8 cm
Extra-schmaler LED-Strip

3 m

Farbtemperatur	Leistung (W)	Länge (cm)	Art. Nr.
blau	12	300	552727

Um gleichbleibende Lichtleistung ab einer Länge von 1,5 m zu erhalten, empfehlen wir die Strips beidseitig einzuspeisen.
 Ab einer Länge von 3 m muss neu eingespeist werden.



i Um die Wärmeableitung zu gewährleisten, müssen die LED-Strips in ein Aluminiumprofil geklebt werden. Rückseite der LED-Strips mit Klebeband.

PROFIL-STRIP SELECT

24V



PROFIL-STRIP SELECT, 24V



120 LEDs pro m
 Breite/Höhe: 0,8/0,2 cm
 LED-Abstand: 0,8 cm
 Trennbar alle 5 cm
 minimaler Biegeradius: 3,8 cm

5 m, CRI>80

Farbtemperatur	Lichtstrom (lm)	Leistung (W)	Farbwiedergabeindex (CRI)	Farbkonsistenz	Länge (cm)	Energieeffizienzklasse	Art. Nr.
2700K	4000	40	>80	3SDCM	500	A+	552692
3000K							552693
4000K							552694

Um gleichbleibende Lichtleistung ab einer Länge von 2,5 m zu erhalten, empfehlen wir die Strips beidseitig einzuspeisen. Ab einer Länge von 5 m muss neu eingespeist werden.

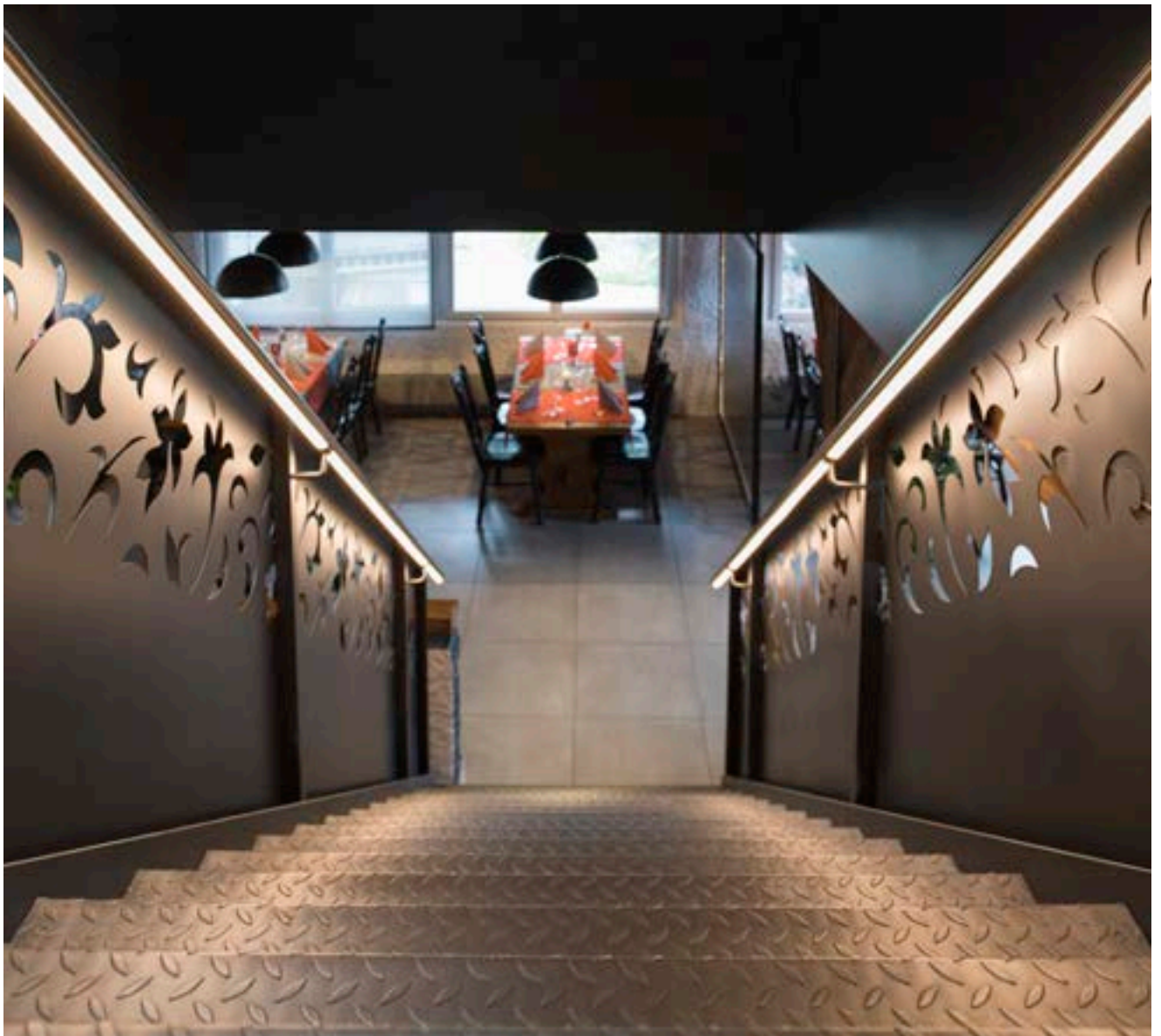

Um die Wärmeableitung zu gewährleisten, müssen die LED-Strips in ein Aluminiumprofil geklebt werden. Rückseite der LED-Strips mit Klebeband.

FLEXLED ROLL SELECT

24V



FLEXLED ROLL SELECT, 24V



60 LEDs pro m
 Breite/Höhe: 0,8/0,1 cm
 LED-Abstand: 1,7 cm
 Trennbar alle 10 cm
 minimaler Biegeradius: 1,3 cm

5 m, CRI>80

Farbtemperatur	Lichtstrom (lm)	Leistung (W)	Farbwiedergabeindex (CRI)	Farbkonsistenz	Länge (cm)	Energieeffizienzklasse	Art. Nr.
2700K	2500	25	>80	3SDCM	500	A+	552422
3000K	2550						552423
5000K	2850						552425

Um bei größeren Längen gleichbleibende Lichtleistung zu erhalten, sollten die Strips beidseitig eingespeist werden. Ab einer Länge von 5 m muss neu eingespeist werden.

ZUBEHÖR FLEXLED ROLL SELECT, 24V

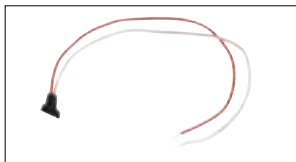

Einspeiser, 30 cm Kabel



Direktverbinder



Verbinder

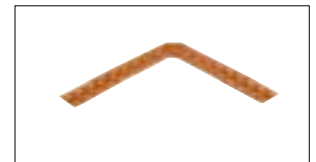

90° Lötcken

Variante	Strombelastung max.	Material	Länge (cm)	Breite (cm)	Höhe (cm)	Art. Nr.
■ Einspeiser, 1 Stk.	2A	Kunststoff	50	1,5	0,5	550412
■ Direktverbinder, 2 Stk.	2A	Kunststoff	1,4	1,4	0,4	550415
□ Verbinder, 1 Stk.	10A	Kunststoff P	2,7	1,4	1,1	550560
■ 90° Lötcken, 1 Stk.	2A	-	5	0,8	-	550571

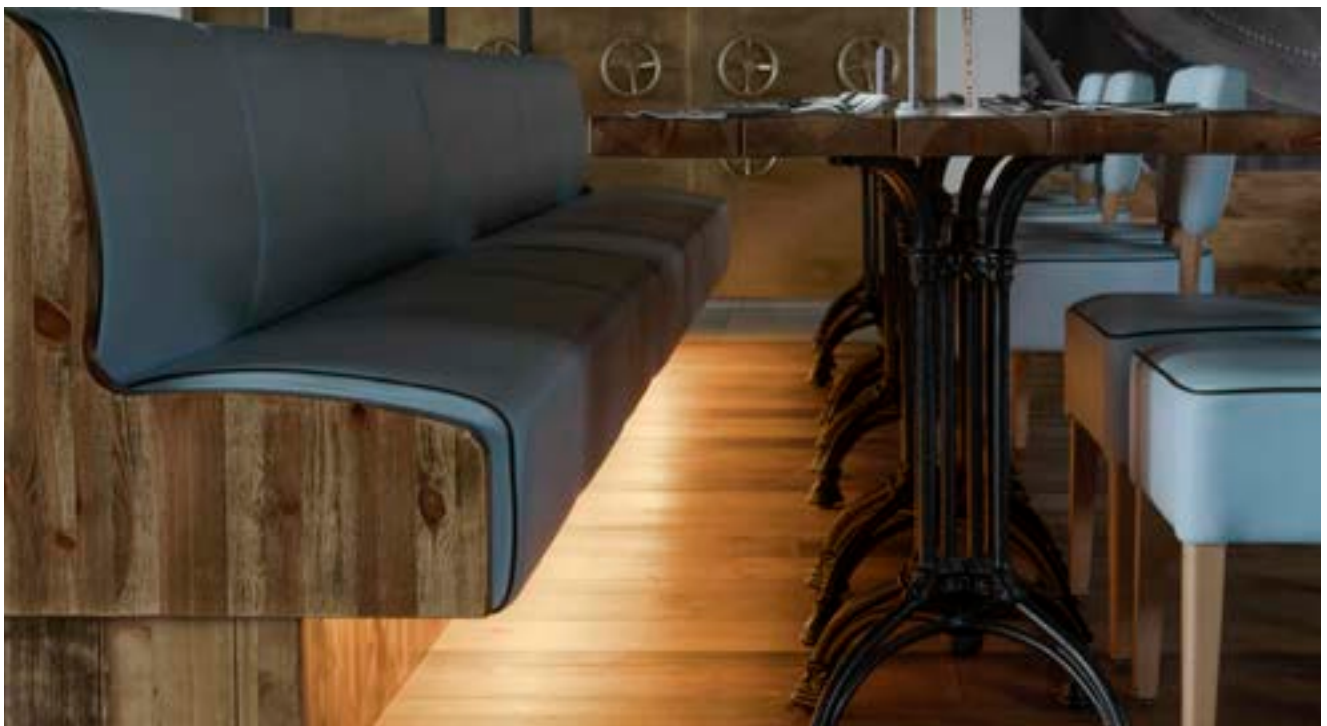

Um die Wärmeableitung zu gewährleisten, müssen die LED-Strips in ein Aluminiumprofil geklebt werden. Rückseite der LED-Strips mit Klebeband.

LED-STRIP

24V



LED-STRIP, 24V



60 LEDs pro m
 Breite/Höhe: 1/0,2 cm
 LED-Abstand: 1,7 cm
 Trennbar alle 10 cm
 minimaler Biegeradius: 1,3 cm

3 m, CRI>80

Farbtemperatur	Lichtstrom (lm)	Leistung (W)	Farbwiedergabeindex (CRI)	Farbkonsistenz	Länge (cm)	Energieeffizienzklasse	Art. Nr.
2700K	2775	30	>80	3SDCM	300	A+	552442
3000K	3000						552443
4000K	3600						552445

Um bei größeren Längen gleichbleibende Lichtleistung zu erhalten, sollten die Strips beidseitig eingespeist werden. Ab einer Länge von 3 m muss neu eingespeist werden.

ZUBEHÖR LED-STRIP

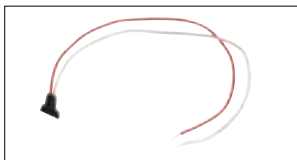

Einspeiser, 30 cm Kabel



Direktverbinder



Verbinder

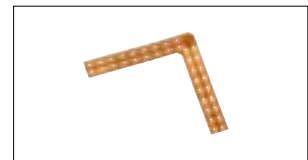

90° Lötcken

Variante	Strombelastung max.	Material	Länge (cm)	Breite (cm)	Höhe (cm)	Art. Nr.
■ Einspeiser, 1 Stk.	2A	Kunststoff	30	–	–	550413
■ Direktverbinder, 2 Stk.	2A	Kunststoff	1,4	1,6	0,4	550416
□ Verbinder, 1 Stk.	10A	Kunststoff P	2,7	1,4	1,1	550560
■ 90° Lötcken, 1 Stk.	2A	–	5	0,8	–	550570



Um die Wärmeableitung zu gewährleisten, müssen die LED-Strips in ein Aluminiumprofil geklebt werden. Rückseite der LED-Strips mit Klebeband.

FLEXLED ROLL

24V



FLEXLED ROLL, 24V

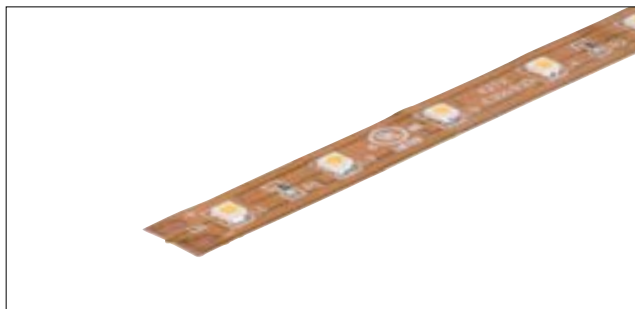

60 LEDs pro m
Breite/Höhe: 1/0,2 cm
LED-Abstand: 1,7 cm
Trennbar alle 10 cm
minimaler Biegeradius: 1,3 cm

5 m, CRI>80

Farbtemperatur	Lichtstrom (lm)	Leistung (W)	Farbwiedergabeindex (CRI)	Farbkonsistenz	Länge (cm)	Energieeffizienzklasse	Art. Nr.
2700K	1850	20	>80	6SDCM	500	A+	552120
3000K							552122
5000K							552121

Um bei größeren Längen gleichbleibende Lichtleistung zu erhalten, sollten die Strips beidseitig eingespeist werden. Ab einer Länge von 5 m muss neu eingespeist werden.

ZUBEHÖR FLEXLED ROLL, 24V

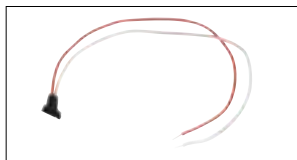

Einspeiser, 30 cm Kabel



Direktverbinder



Verbinder

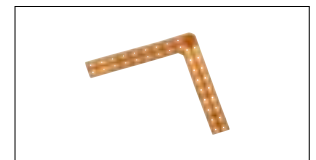

90° Lötcken

Variante	Strombelastung max.	Material	Länge (cm)	Breite (cm)	Höhe (cm)	Art. Nr.
■ Einspeiser, 1 Stk.	2A	Kunststoff	30	–	–	550413
■ Direktverbinder, 2 Stk.	2A	Kunststoff	1,4	1,6	0,4	550416
□ Verbinder, 1 Stk.	10A	Kunststoff P	2,7	1,4	1,1	550560
■ 90° Lötcken, 1 Stk.	2A	–	5	0,8	–	550570



Um die Wärmeableitung zu gewährleisten, müssen die LED-Strips in ein Aluminiumprofil geklebt werden. Rückseite der LED-Strips mit Klebeband.

FLEXLED STRIP

24V



FLEXLED STRIP, 24V



120 LEDs pro m
Breite/Höhe: 1/0,12 cm
LED-Abstand: 0,84 cm
Trennbar alle 5 cm
minimaler Biegeradius: 6 cm

10 m, CRI>80

Farbtemperatur	Lichtstrom (lm)	Leistung (W)	Farbwiedergabeindex (CRI)	Farbkonsistenz	Länge (cm)	Energieeffizienzklasse	Art. Nr.
2200K	10500	121,5	>80	3SDCM	1000	A	1001972
2700K	12000					A+	1002026
3000K	12000					1002027	
4000K	12800					1002028	

Um bei größeren Längen gleichbleibende Lichtleistung zu erhalten, sollten die Strips beidseitig eingespeist werden.



Um die Wärmeableitung zu gewährleisten, müssen die LED-Strips in ein Aluminiumprofil geklebt werden. Rückseite der LED-Strips mit Klebeband.



FLEXLED STRIP, 24V



48 LEDs pro m
 Breite/Höhe: 1/0,12 cm
 LED-Abstand: 1,7 cm
 Trennbar alle 10 cm
 minimaler Biegeradius: 3 cm

80 m, CRI>90

Farbtemperatur	Lichtstrom (lm)	Leistung (W)	Farbwiedergabeindex (CRI)	Farbkonsistenz	Länge (cm)	Energieeffizienzklasse	Art. Nr.
2200K	17600	211.2	>90	4SDCM	8000	A	1002996
2700K	19200					A+	1002997
3000K	19200					1002998	
4000K	21600					1002999	

Um gleichbleibende Lichtleistung bei einer Länge von 80 m zu erhalten, empfehlen wir die Strips beidseitig einzuspeisen. Bei einseitiger Einspeisung muss ab einer Länge von 40 m neu eingespeist werden.



Extra langer Strip 80 m



Um die Wärmeableitung zu gewährleisten, müssen die LED-Strips in ein Aluminiumprofil geklebt werden. Rückseite der LED-Strips mit Klebeband.

FLEXSTRIP LED HIGH LUMEN

24V

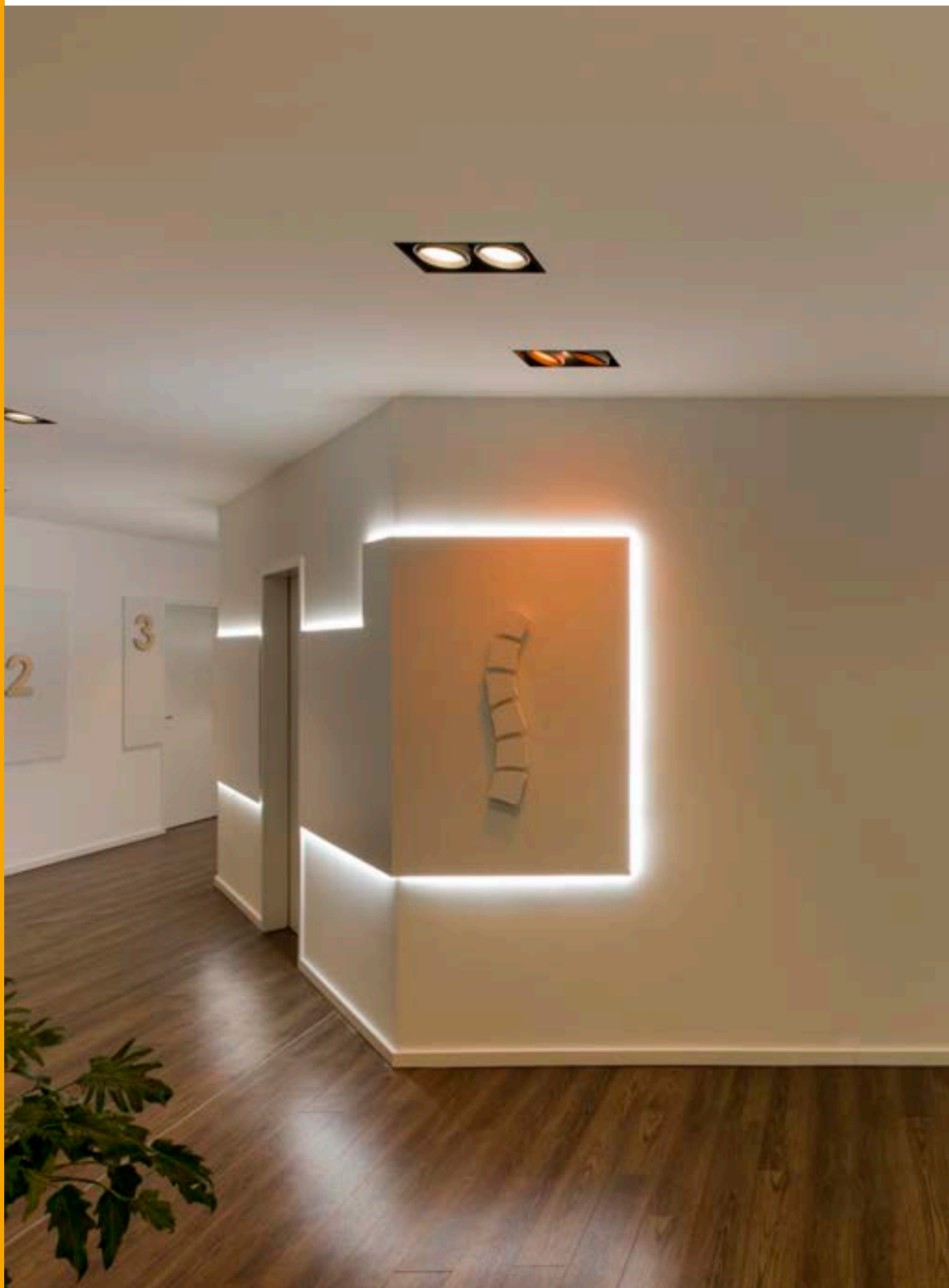

FLEXSTRIP LED HIGH LUMEN, 24V



120 LEDs pro m
Breite/Höhe: 1/0,1 cm
LED-Abstand: 0,8 cm
Trennbar alle 5 cm
minimaler Biegeradius: 1,3 cm

2 m, CRI>80

Farbtemperatur	Lichtstrom (lm)	Leistung (W)	Farbwiedergabeindex (CRI)	Farbkonsistenz	Länge (cm)	Energieeffizienzklasse	Art. Nr.
2700K	3800	42	>80	3SDCM	200	A	552482
3000K	3880						552483
5000K	4300						552485

Um bei größeren Längen gleichbleibende Lichtleistung zu erhalten, sollten die Strips beidseitig eingespeist werden.

ZUBEHÖR FLEXSTRIP LED HIGH LUMEN 24V

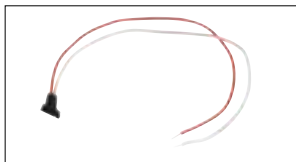

Einspeiser, 30 cm Kabel



Direktverbinder



Verbinder

Variante	Strombelastung max.	Material	Länge (cm)	Breite (cm)	Höhe (cm)	Art. Nr.
■ Einspeiser, 1 Stk.	2A	Kunststoff	30	-	-	550413
■ Direktverbinder, 2 Stk.	2A	Kunststoff	1,4	1,6	0,4	550416
□ Verbinder, 1 Stk.	10A	Kunststoff P	2,7	1,4	1,1	550560



Um die Wärmeableitung zu gewährleisten, müssen die LED-Strips in ein Aluminiumprofil geklebt werden. Rückseite der LED-Strips mit Klebeband.

FLEXLED ROLL

24V

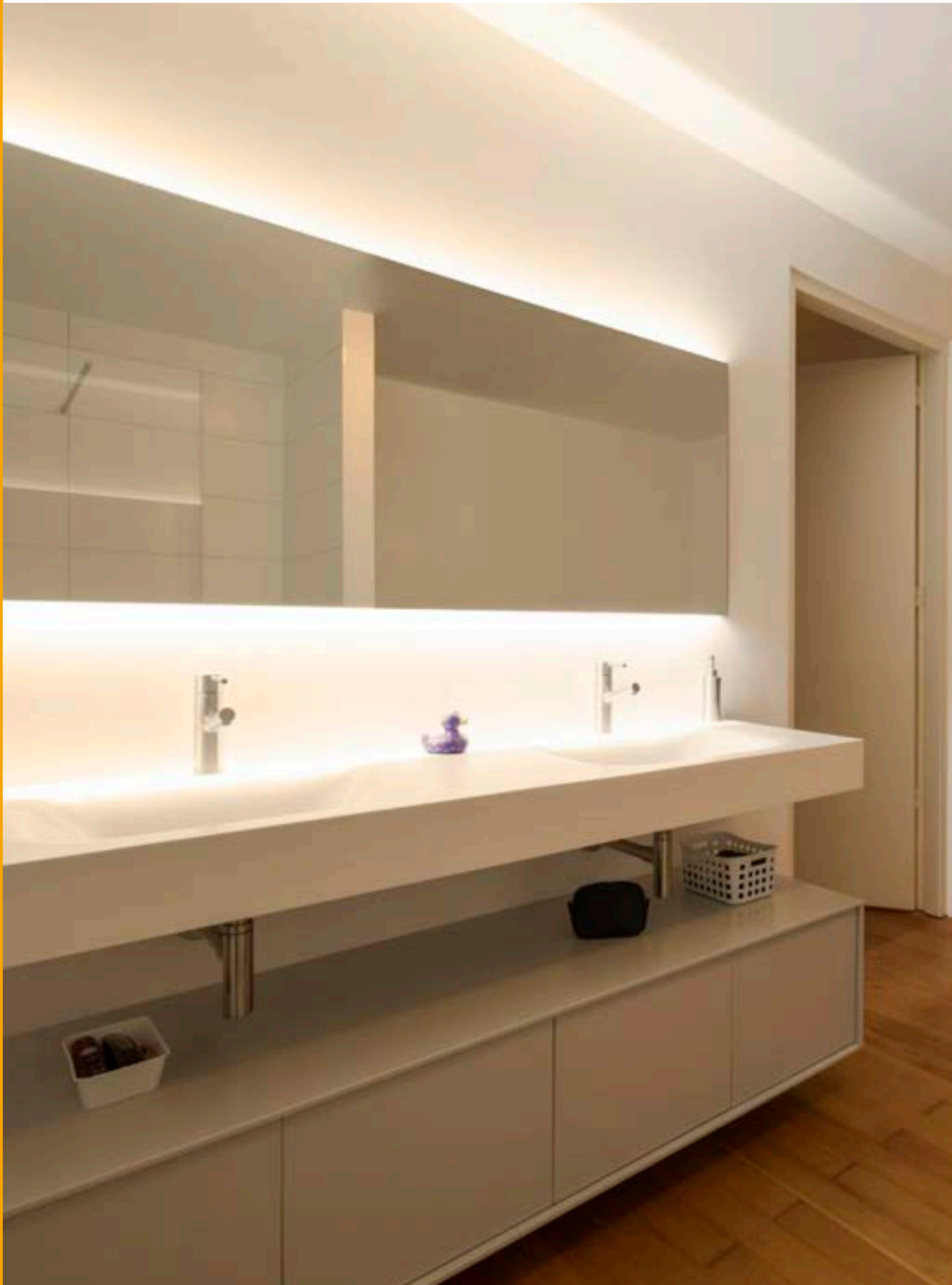

FLEXLED ROLL, 24V



60 LEDs pro m
 Breite/Höhe: 0,6/0,1 cm
 LED-Abstand: 1,6 cm
 Trennbar alle 10 cm

5 m, CRI>80

Farbtemperatur	Lichtstrom (lm)	Leistung (W)	Farbwiedergabeindex (CRI)	Farbkonsistenz	Länge (cm)	Energieeffizienzklasse	Art. Nr.
2700K	1925	20	>80	3SDCM	500	A+	552522
3000K	1975						552523
5000K	2350						552525

Um bei größeren Längen gleichbleibende Lichtleistung zu erhalten, sollten die Strips beidseitig eingespeist werden.

ZUBEHÖR FLEXLED ROLL 24V

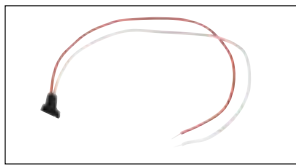

Einspeiser, 30 cm Kabel



Direktverbinder



Verbinder

Variante	Strombelastung max.	Material	Länge (cm)	Breite (cm)	Höhe (cm)	Art. Nr.
<input type="checkbox"/> Einspeiser, 1 Stk.	2A	Kunststoff	50	-	-	550412
<input checked="" type="checkbox"/> Direktverbinder, 2 Stk.	2A	Kunststoff	1,4	1,4	0,4	550415
<input type="checkbox"/> Verbinder, 1 Stk.	10A	Kunststoff P	2,7	1,4	1,1	550560



Um die Wärmeableitung zu gewährleisten, müssen die LED-Strips in ein Aluminiumprofil geklebt werden. Rückseite der LED-Strips mit Klebeband.

KELVIN CONTROL-STRIP

24V



KELVIN CONTROL-STRIP, 24V



240 LEDs pro m
Breite/Höhe: 1/0,2 cm
Trennbar alle 5 cm
minimaler Biegeradius: 3,8 cm
Passend zum Kelvin Control System
Lichtfarbe von 2700K-6500K einstellbar

3 m, CRI>80

Farbtemperatur	Lichtstrom (lm)	Leistung (W)	Farbwiedergabeindex (CRI)	Farbkonsistenz	Länge (cm)	Energieeffizienzklasse	Art. Nr.
2700K - 6500K	1881 - 3921	18 - 36	>80	3SDCM	300	A+	552863
2700K - 6500K	3522 - 7230	37,5 - 75				A	552883

Um gleichbleibende Lichtleistung ab einer Länge von 1,5 m zu erhalten, empfehlen wir die Strips beidseitig einzuspeisen. Ab einer Länge von 3 m muss neu eingespeist werden.

ZUBEHÖR KELVIN CONTROL-STRIP 24V



KELVIN CONTROL Master Controller mit Fernbedienung



KELVIN CONTROL Slave Controller



KELVIN CONTROL Fernbedienung

Variante	Material	Länge (cm)	Breite (cm)	Höhe (cm)	Art. Nr.
<input type="checkbox"/> KELVIN CONTROL Master Controller, 1 Stk.	Kunststoff P	8,6	2,1	0,9	470681
<input type="checkbox"/> KELVIN CONTROL Slave Controller, 1 Stk.	Kunststoff P	8,6	2,1	0,9	470682
<input type="checkbox"/> KELVIN CONTROL Fernbedienung, 1 Stk.	Kunststoff P	11,4	5,6	2,4	470683



Um die Wärmeableitung zu gewährleisten, müssen die LED-Strips in ein Aluminiumprofil geklebt werden. Rückseite der LED-Strips mit Klebeband.

FLEXSTRIP LED RGB

24V

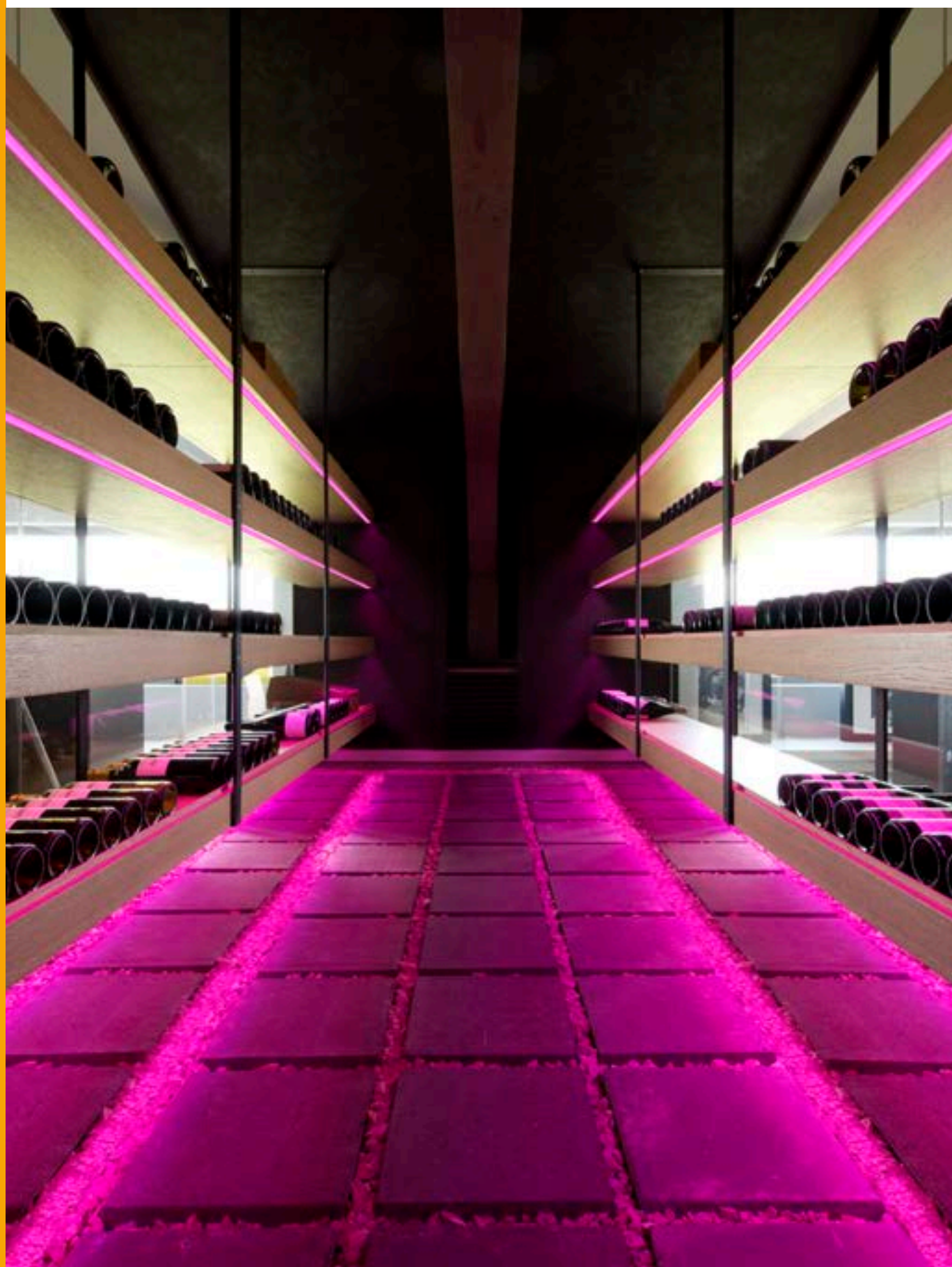

FLEXSTRIP LED RGB, 24V



60 LEDs pro m
 Breite/Höhe: 1/0,2 cm
 LED-Abstand: 1,6 cm
 Trennbar alle 10 cm
 minimaler Biegeradius: 1,3 cm

5 m

Farbtemperatur	Leistung (W)	Länge (cm)	Art. Nr.
RGB	75	500	552649

Ab einer Länge von 1,5 m muss beidseitig eingespeist werden. Ab einer Länge von 3 m muss neu eingespeist werden.

ZUBEHÖR FLEXSTRIP LED RGB 24V



Einspeiser, 50 cm Kabel



Direktverbinder



Flexverbinder, 10 cm Kabel



Lötecken 90°

Variante	Strombelastung max.	Material	Länge (cm)	Breite (cm)	Höhe (cm)	Art. Nr.
<input type="checkbox"/> Einspeiser, 1 Stk.	2,1A	Kunststoff	30	1,5	0,5	552650
<input type="checkbox"/> Direktverbinder, 1 Stk.	2,1A	Kunststoff	1,6	1,4	0,5	552651
<input type="checkbox"/> Flexverbinder, 1 Stk.	2,1A	Kunststoff	1,7	1,5	0,5	552652
<input checked="" type="checkbox"/> Lötecken 90°, 1 Stk.	2A		5,2	5,2	0,01	552653



Um die Wärmeableitung zu gewährleisten, müssen die LED-Strips in ein Aluminiumprofil geklebt werden. Rückseite der LED-Strips mit Klebeband.

FLEXLED ROLL MULTICOLOUR RGBW, 24V



FLEXLED ROLL MULTICOLOUR RGBW, 24V



60 LEDs pro m
Breite/Höhe: 1,2/0,2 cm
LED-Abstand: 1,7 cm
Trennbar alle 10 cm
minimaler Biegeradius: 1,3 cm

3 m, CRI>80

Farbtemperatur	Leistung (W)	Farbwiedergabeindex (CRI)	Farbkonsistenz	Länge (cm)	Energieeffizienzklasse	Art. Nr.
RGBW	48	>80	6SDCM	300	A	552453

Um gleichbleibende Lichtleistung ab einer Länge von 1,5 m zu erhalten, empfehlen wir die Strips beidseitig einzuspeisen. Ab einer Länge von 3 m muss neu eingespeist werden.

ZUBEHÖR FLEXLED ROLL MULTICOLOUR RGBW 24V

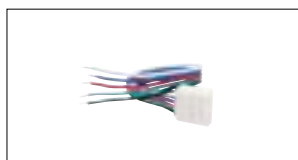

Einspeiser, 50 cm Kabel



Direktverbinder



Verbinder, 10 cm Kabel

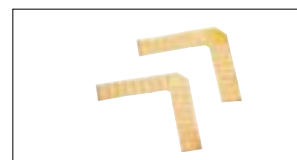

Lötecken 90°

Variante	Strombelastung max.	Material	Länge (cm)	Breite (cm)	Höhe (cm)	Art. Nr.
<input type="checkbox"/> Einspeiser, 1 Stk.	2A	Kunststoff	50	–	–	552460
<input type="checkbox"/> Direktverbinder, 1 Stk.	2A	Kunststoff	1,6	1,6	0,5	552461
<input type="checkbox"/> Verbinder, 1 Stk.	2A	–	10	–	–	552462
<input checked="" type="checkbox"/> Lötecken 90°, 2 Stk.	2A	–	5,2	5,2	0,01	552463

 Um die Wärmeableitung zu gewährleisten, müssen die LED-Strips in ein Aluminiumprofil geklebt werden. Rückseite der LED-Strips mit Klebeband.

FLEXLED ROLL RGB

24V



FLEXLED ROLL RGB, 24V



120 LEDs pro m
Breite/Höhe: 2/0,15 cm
LED-Abstand: 0,8 cm
Trennbar alle 5 cm
minimaler Biegeradius: 3,8 cm
IP-Schutzart: IP20

3 m

Farbtemperatur	Leistung (W)	Länge (cm)	Art. Nr.
RGB	72	300	1001971

Um gleichbleibende Lichtleistung ab einer Länge von 1,5 m zu erhalten, empfehlen wir die Strips beidseitig einzuspeisen.
 Ab einer Länge von 3 m muss neu eingespeist werden.



Um die Wärmeableitung zu gewährleisten, müssen die LED-Strips in ein Aluminiumprofil geklebt werden. Rückseite der LED-Strips mit Klebeband.

FLEX ROLL

24V



FLEX ROLL, 24V



60 LEDs pro m
Breite/Höhe: 1,3/0,5 cm
LED-Abstand: 1,7 cm
Trennbar alle 10 cm
minimaler Biegeradius: 3,75 cm
IP-Schutzart: IP55

5 m, CRI>80

Farbtemperatur	Lichtstrom (lm)	Leistung (W)	Farbwiedergabeindex (CRI)	Farbkonsistenz	Länge (cm)	Energieeffizienzklasse	Art. Nr.
3000K	1500	25	>80	6SDCM	500	A	552273

Um bei größeren Längen gleichbleibende Lichtleistung zu erhalten, empfehlen wir die Strips beidseitig einzuspeisen. Ab einer Länge von 5 m muss neu eingespeist werden.

 Um die Wärmeableitung zu gewährleisten, müssen die LED-Strips in ein Aluminiumprofil geklebt werden. Rückseite der LED-Strips mit Klebeband.

DELFD

24V



DELFD, 24V

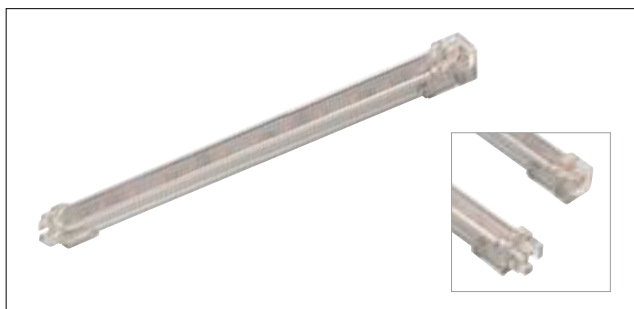

24V DC
Breite/Höhe: 1,5/1,4 cm
Material: Aluminium/Kunststoff
Schutzklasse: III
Halbstreuwinkel: 110°

Stecksystem, werkzeuglos verlängerbar bis 3 m

aluminium

Farbtemperatur	Lichtstrom (lm)	Leistung (W)	Farbwiedergabeindex (CRI)	Länge (cm)	Gewicht (kg)	Energieeffizienzklasse	Art. Nr.
3000K	105	1,5	>80	10,5	0,02	A-A++	631501
	190	2,6		20,5	0,04		631502
	500	6,3		50,5	0,08		631505
	1000	13,4		100,5	0,15		631510
	1100	15,7		120,5	0,19		631512

ZUBEHÖR DELFD, 24V



Einspeiser, 1,5 m Kabel



Verbinder, 12 cm Kabel



Montageclips



Montageclips 45°

Variante	Strombelastung max.	Material	Länge (cm)	Breite (cm)	Höhe (cm)	Art. Nr.
■ Einspeiser, 1 Stk.	2A	Kunststoff	150	–	–	631520
■ Verbinder, 1 Stk.	2A	Kunststoff	15	–	–	631521
■ Montageclips, 10 Stk.	–	Edelstahl	1	1,5	0,9	631522
■ Montageclips 45°, 10 Stk.	–	Edelstahl	1	1,5	1,7	631523

BATTEN LED

220-240V ~50/60HZ



BATTEN LED 220-240V ~50/60Hz



220-240V ~50/60Hz 67V DC
Breite/Höhe: 2,5/3,5cm
Material: Kunststoff PC
Schutzklasse: II
Umgebungstemperatur -20°C bis 40°C
Halbstreuwinkel 155°

Werkzeuglos verlängerbar

matt weiß

Farbtemperatur	Lichtstrom (lm)	Leistung (W)	Farbwiedergabeindex (CRI)	Länge (cm)	Gewicht (kg)	Energieeffizienzklasse	Art. Nr.
3000K	735	8,1	>80	57,5	0,17	A-A++	631313
	1065	12,4		87,5	0,23		631315
	1470	16,5		117,5	0,29		631317
4000K	855	8,1		57,5	0,17		631323
	1235	12,4		87,5	0,23		631325
	1710	16,5		117,5	0,28		631327

ZUBEHÖR BATTEN LED 220-240V ~50/60Hz

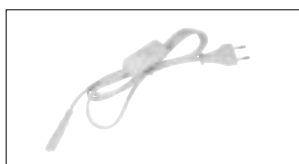

Einspeisekabel mit Schalter,
1,5 m Kabel

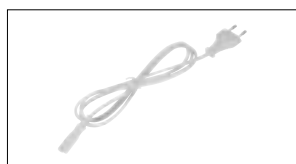

Einspeisekabel, 1,5 m Kabel

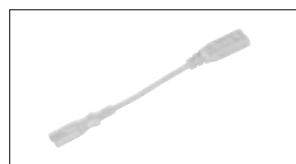

Verbindungskabel, 15 cm Kabel

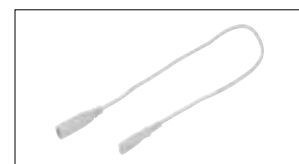

Verbindungskabel, 15 cm Kabel



Befestigungsklammern 45°



Verbinder

Variante	Strombelastung max.	Material	Länge (cm)	Breite (cm)	Höhe (cm)	Art. Nr.
<input type="checkbox"/> Einspeisekabel mit Schalter, 1 Stk.	2A	Kunststoff	150	–	–	631300
<input type="checkbox"/> Einspeisekabel, 1 Stk.	2A	Kunststoff	150	–	–	631301
<input type="checkbox"/> Verbindungskabel, 1 Stk.	2A	Kunststoff	15	–	–	631302
<input type="checkbox"/> Verbindungskabel, 1 Stk.	2A	Kunststoff	50	–	–	631303
<input checked="" type="checkbox"/> Befestigungsklammern 45°, 3 Stk.	–	Stahl	2,5	1,3	1,2	631304
<input type="checkbox"/> Verbinder, 1 Stk.	2A	Kunststoff	2,2	2	1,1	631305





EINFACH. KOMPATIBEL. SMART.

Das SLV VALETO® SMART LIGHT SYSTEM ist die intelligente Lichtlösung für das Zuhause, Hotel-, Restaurant- und Shopkonzepte. Dank des ZigBee® 3.0 Standards genießen Sie die Kompatibilität mit vielen gängigen Smart Home Systemen:

Philips Hue | **Osram Smart+** | **Amazon Alexa**

Die Steuerung funktioniert ganz einfach via Fernbedienung, App oder über Sprachbefehle mit Hilfe von Amazon Alexa. Und natürlich lässt sich SLV VALETO® SMART LIGHT SYSTEM auch in bestehende Elektroinstallationen integrieren.



Foto Stock: © Mathias Wegert, © blacksheep



Skalierbar:

Mit dem SLV VALETO® Gateway lassen sich Installationen mit bis zu 200 Leuchten realisieren.



Integrierbar:

SLV VALETO® ist, dank des ZigBee® 3.0 Standards, kompatibel mit Produkten und Systemen anderer Hersteller.



Steuerbar:

Kann via App, Fernbedienung oder Sprachassistenzsysteme ganz einfach gesteuert werden.



Reichweitenstark:

Durch den Aufbau eines eigenen Mesh-Netzwerks lassen sich SLV VALETO® Produkte auch über große Distanzen steuern.*



Sicher:

Das Gateway speichert Ihre Daten nur lokal und speichert nichts in der Cloud.

*Ausgeschlossen sind die batteriebetriebenen Geräte.

SIMPLE.

Der ideale Einstieg in die smarte Lichtsteuerung: Koppeln Sie einfach unsere SLV VALETO® Fernbedienungen (bspw.: 1002994) mit den SLV VALETO® Leuchtmitteln (bspw.: 1001917) und sehen Sie wie einfach smart sein kann.



Fernbedienung
Art. Nr. 1002994



Leuchtmittel
Art. Nr. 1001917



ADVANCE.

Darf es etwas mehr sein?

Mit unserem SLV VALETO® SMART LIGHT SYSTEM haben Sie die Wahl: Steuern Sie das Licht Zuhause mit unserer SLV VALETO® Fernbedienung (1002994), oder einer App auf Ihrem Smartphone über unser SLV VALETO® Gateway (1002411). Dank des neuesten ZigBee Standards (ZigBee® 3.0) sind Ihnen bei Ihrer smarten Lichtsteuerung keine Grenzen gesetzt.



12/24V Strip, Steuermodul
Art. Nr. 1001859



Leuchtmittel



Fernbedienung
Art. Nr. 1002994



Gateway
Art. Nr. 1002411



PROFESSIONAL.

Große Pläne?

Mit unserem SLV VALETO® SMART LIGHT SYSTEM lassen sich problemlos über 150 smarte Produkte in einer smarten Lichtsteuerung integrieren. Steuern Sie ganz einfach zu jeder Zeit, von überall Ihre Geräte und setzen Sie Ihr Projekt perfekt in Szene.



12/24V Strip, Steuermodul
Art. Nr. 1001859



Leuchtmittel



Phase cut dimmer
Art. Nr. 1002995



Gateway
Art. Nr. 1002411

MEHR KOMFORT UND SICHERHEIT

Die ideale Lösung zur kabellosen Bedienung und Überwachung von einzelnen Leuchten, über ganze Räume bis zur kompletten Wohnumgebung.

The diagram illustrates a smart lighting system in a house. A central 'SLV VALETO® Gateway' device is shown in the living room, connected via wireless signals to various smart light fixtures (lamps, ceiling lights, and table lamps) throughout the house, including the bedroom, bathroom, and dining area. To the left, a smartphone displays the 'SLV VALETO® App' interface, with a QR code and download instructions for the App Store and Google Play.

SLV VALETO® App

Download on the App Store

GET IT ON Google Play

SLV VALETO® Gateway



KOMMUNIKATION.

Das Herzstück des Smart Light Systems bildet das SLV VALETO® Gateway

SLV VALETO® Gateway

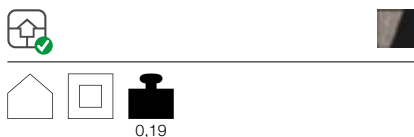

Produktangaben

220-240V ~50/60Hz
 Betriebsspannung: 5V DC
 Leistung: <1W
 L: 10,6 cm B: 10,6 cm H: 2,6 cm
 Material: Aluminium/Kunststoff

Hinweis

ZigBee® 3.0 zertifiziertes Produkt.
 Zur Steuerung des Gateway's wird eine Verbindung per LAN-Kabel zu einem Router vorausgesetzt.

Lieferumfang

SLV VALETO® Gateway
 Steckernetzteil 5V, 1A
 Netzwerkkabel, CAT6, 2m, schwarz

Variante	Art. Nr.
metall gebürstet/schwarz	1002411



INTEGRIERBAR



GERMAN ENGINEERING



REICHWEITENSTARK



SICHER



LICHTSYSTEME.

LED A60 E27, CCT



Produktangaben

220-240V ~50/60Hz
 Leistung: 9W
 Ø: 6 cm H: 12 cm

Hinweis

Fernsteuerbar und dimmbar mit SLV VALETO® CCT/RGBW Fernbedienung [1002994] oder Gateway [1002411]

Lampenstrom	0,052A
Leistung	9W
Energieverbrauch/1000h	9kWh
Farbtemperatur	2700K-6500K
Lichtstrom	806lm
Farbwiedergabeindex	>80

Variante	Art. Nr.
	1001916

LED A60 E27, RGBW



Produktangaben

220-240V ~50/60Hz
 Leistung: 9,5W
 Ø: 6 cm H: 12 cm

Hinweis

Fernsteuerbar und dimmbar mit SLV VALETO® CCT/RGBW Fernbedienung [1002994] oder Gateway [1002411]

Lampenstrom	0,054A
Leistung	9,5W
Energieverbrauch/1000h	10kWh
Farbtemperatur	RGBW
Lichtstrom	806lm
Farbwiedergabeindex	>80

Variante	Art. Nr.
	1001917

LED QPAR51 GU10, CCT

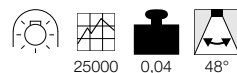

Produktangaben

220-240V ~50/60Hz
 Leistung: 5,1W
 Ø: 5 cm H: 5,4 cm

Hinweis

Fernsteuerbar und dimmbar mit SLV VALETO® CCT/RGBW Fernbedienung [1002994] oder Gateway [1002411]

Lampenstrom	0,027A
Leistung	5,1W
Energieverbrauch/1000h	6kWh
Farbtemperatur	2700-6500K
Lichtstrom	350lm
max. Lichtstärke	500cd
Farbwiedergabeindex	>80

Variante	Art. Nr.
	1001918

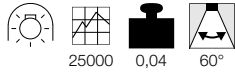

LICHTSYSTEME.

LED QPAR51
GU10, RGBWA+ Spektrum
A++-E

25000 0,04 60°

Produktangaben

220-240V ~50/60Hz
Leistung: 5,6W
Ø: 5 cm H: 5,4 cm

Hinweis

Fernsteuerbar und dimmbar mit SLV VALETO®
CCT/RGBW Fernbedienung [1002994] oder
Gateway [1002411]

Lampenstrom	0,041A
Leistung	5,6W
Energieverbrauch/1000h	6kWh
Farbtemperatur	RGBW
Lichtstrom	350lm
Farbwiedergabeindex	>80

Variante	Art. Nr.
	1001919

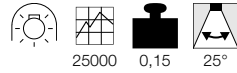
LED QPAR111
GU10, CCTA+ Spektrum
A++-E

25000 0,15 25°

Produktangaben

220-240V ~50/60Hz
Leistung: 9W
Ø: 11,1 cm H: 7 cm

Hinweis

Fernsteuerbar und dimmbar mit SLV VALETO®
CCT/RGBW Fernbedienung [1002994] oder
Gateway [1002411]

Lampenstrom	0,048A
Leistung	9W
Energieverbrauch/1000h	9kWh
Farbtemperatur	2700K-6500K
Lichtstrom	800lm
max. Lichtstärke	3300cd
Farbwiedergabeindex	>80

Variante	Art. Nr.
	1001920

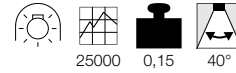
LED QPAR111
GU10, CCTA+ Spektrum
A++-E

25000 0,15 40°

Produktangaben

220-240V ~50/60Hz
Leistung: 9W
Ø: 11,1 cm H: 7 cm

Hinweis

Fernsteuerbar und dimmbar mit SLV VALETO®
CCT/RGBW Fernbedienung [1002994] oder
Gateway [1002411]

Lampenstrom	0,048A
Leistung	9W
Energieverbrauch/1000h	9kWh
Farbtemperatur	2700K-6500K
Lichtstrom	800lm
max. Lichtstärke	1900cd
Farbwiedergabeindex	>80

Variante	Art. Nr.
	1001921

LED QPAR111
GU10, RGBWA+ Spektrum
A++-E

25000 0,15 25°

Produktangaben

220-240V ~50/60Hz
Leistung: 9W
Ø: 11,1 cm H: 7 cm

Hinweis

Fernsteuerbar und dimmbar mit SLV VALETO®
CCT/RGBW Fernbedienung [1002994] oder
Gateway [1002411]

Lampenstrom	0,048A
Leistung	9W
Energieverbrauch/1000h	9kWh
Farbtemperatur	RGBW
Lichtstrom	800lm
Farbwiedergabeindex	>80

Variante	Art. Nr.
	1001922

LED QPAR111
GU10, RGBWA+ Spektrum
A++-E

25000 0,15 40°

Produktangaben

220-240V ~50/60Hz
Leistung: 9W
Ø: 11,1 cm H: 7 cm

Hinweis

Fernsteuerbar und dimmbar mit SLV VALETO®
CCT/RGBW Fernbedienung [1002994] oder
Gateway [1002411]

Lampenstrom	0,048A
Leistung	9W
Energieverbrauch/1000h	9kWh
Farbtemperatur	RGBW
Lichtstrom	800lm
Farbwiedergabeindex	>80

Variante	Art. Nr.
	1001923



BEDIENELEMENTE.

SLV VALETO®
Fernbedienung, CCT/RGBW

IP 20



0,068

Produktangaben

Spannung: 3V Batteriebetrieb
L: 6,5 cm B: 6,5 cm H: 1,95 cm
Material: Kunststoff P

Hinweis

Die SLV VALETO® CCT/RGBW Fernbedienung kann bis zu 20 ZigBee® Geräte in drei Gruppen steuern. CCT und RGBW-Einstellungen möglich.

Variante	Art. Nr.
weiß	1002994

SLV VALETO®
Fernbedienung

IP 20



0,06

Produktangaben

Spannung: 3V Batteriebetrieb
L: 10 cm B: 5,7 cm H: 1,8 cm
Material: ABS/Kunststoff P

Hinweis

Diese Fernbedienung kann ausschließlich zur Dimmung und Ein- und Ausschalten von SLV VALETO® Produkten verwendet werden. CCT und RGBW-Einstellungen nicht möglich.

Variante	Art. Nr.
weiß/anthrazit	1002097



STEUERGERÄTE.

SLV VALETO®
phase cut dimmer

IP 20



0,04

Produktangaben

220-240V ~50/60Hz
Leistung: max. 200W
L: 4,5 cm B: 4,5 cm H: 2,2 cm
Material: Kunststoff P

Hinweis

Steuerbar mit SLV VALETO® CCT/RGBW Fernbedienung [1002994] oder Gateway [1002411]. Als unabhängiger Dimmer ohne ZigBee® nutzbar. Dimmverfahren: Phasenabschnitt. Dimmer für ohmsche (Hochvolt Halogen Leuchtmittel) und kapazitive Lasten (LED Treiber). Passend für jede 60mm UP-Schalterdose mit einer Tiefe von 42mm. 200W LED Last.

Bemessungsspannung	220-240V ~50/60Hz
Ausgangsspannung	220-240V ~50/60Hz
Bemessungsleistung LED	200W
Umgebungstemp. max.	50°C

Variante	Art. Nr.
schwarz	1002995

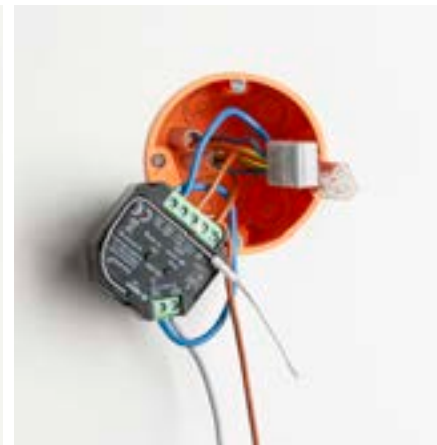



STEUERGERÄTE.

SLV VALETO® 12/24V Strip Steuermodul | CCT

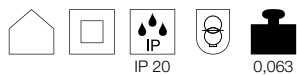

Produktangaben

12V/24V DC
Leistung: max. 192W pro Kanal
L: 13,4 cm B: 3,9 cm H: 2,4 cm
Material: Kunststoff

Hinweis

Fernsteuerbar und dimmbar mit SLV VALETO® CCT/RGBW Fernbedienung [1002994] oder Gateway [1002411]. Das Steuermodul ist dazu geeignet CCT LED Strips zu steuern.

Ausgangsspannung	12/24V
Anzahl Ausgänge sek.	2
Leistung von	1W
Leistung bis	192W
Umgebungstemp. min.	-30°C
Umgebungstemp. max.	60°C
Schutz im Fehlerfall	elektronisch

Variante	Art. Nr.
<input type="checkbox"/> weiß	1001859

SLV VALETO® 12/24V Strip Steuermodul | RGBW

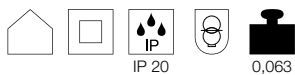

Produktangaben

12V/24V DC
Leistung: max. 96W pro Kanal
L: 13,4 cm B: 3,9 cm H: 2,4 cm
Material: Kunststoff

Hinweis

Fernsteuerbar und dimmbar mit SLV VALETO® CCT/RGBW Fernbedienung [1002994] oder Gateway [1002411]. Das Steuermodul ist dazu geeignet RGBW LED Strips zu steuern.

Ausgangsspannung	12/24V
Anzahl Ausgänge sek.	4
Leistung von	1W
Leistung bis	96W
Umgebungstemp. min.	-30°C
Umgebungstemp. max.	60°C
Schutz im Fehlerfall	elektronisch

Variante	Art. Nr.
<input type="checkbox"/> weiß	1002892

SLV VALETO® 15W, LED Treiber

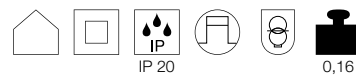

Produktangaben

220-240V~50/60Hz
Leistung: 15W
L: 19 cm B: 6,1 cm H: 3 cm
Material: Kunststoff

Hinweis

Fernsteuerbar und dimmbar mit SLV VALETO® CCT/RGBW Fernbedienung [1002994] oder Gateway [1002411].

Ausgangsstrom	350mA, 500mA, 700mA
Anzahl Ausgänge sek.	1
Leistung	15W
Umgebungstemp. min.	-20°C
Umgebungstemp. max.	40°C
Schutz im Fehlerfall	elektronisch

Variante	Art. Nr.
<input type="checkbox"/> weiß	1002082

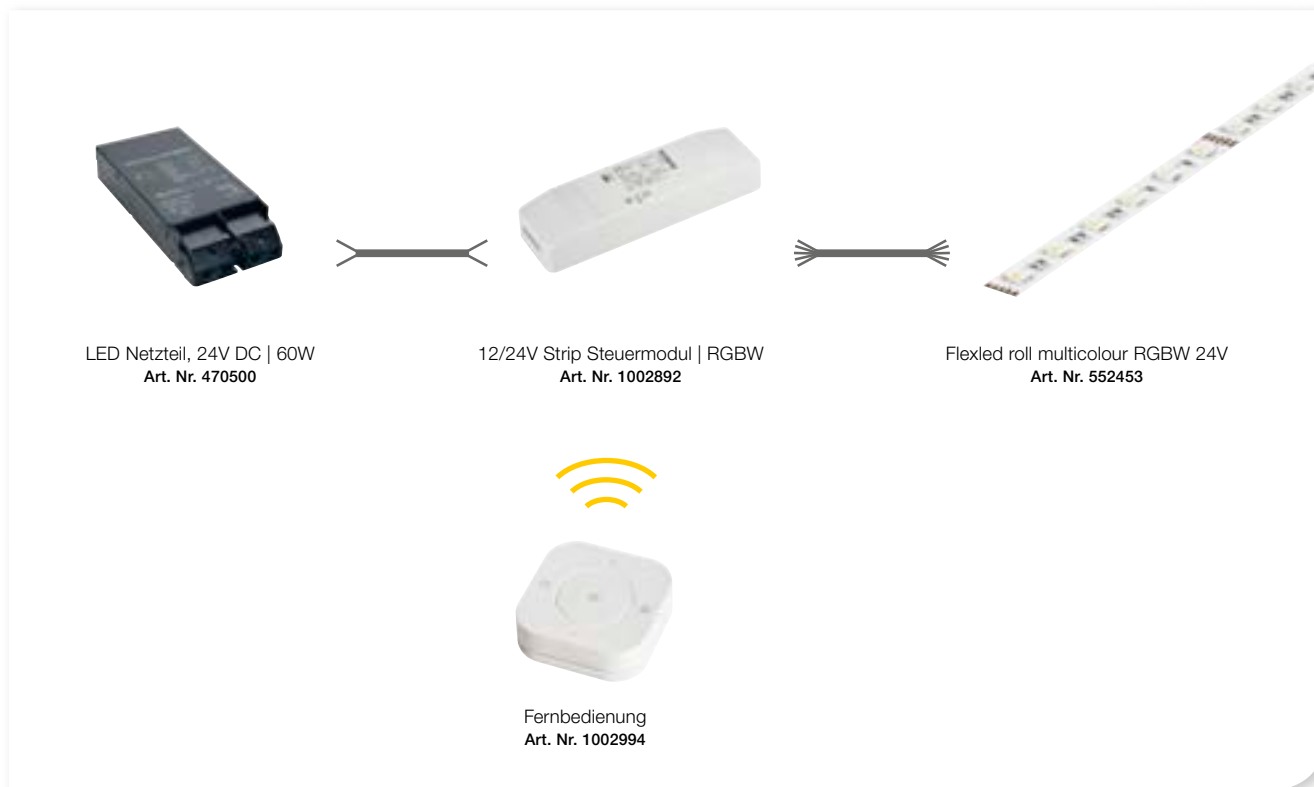

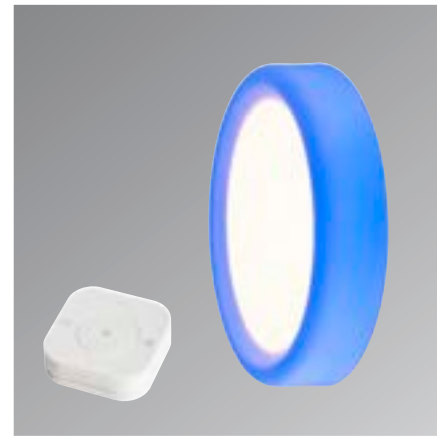
MALANG
 CW, SLV VALETO®

- Integrierbar in das SLV VALETO® System und andere ZigBee® Systeme
- Panel separat steuerbar von warm- bis kaltweiß und dimmbar
- Ring separat steuerbar in RGBW-Farben und dimmbar

Produktangaben

100-240V ~50/60Hz | 24V DC
 Systemleistung: 39W
 Material: Aluminium / Polycarbonat (PC)

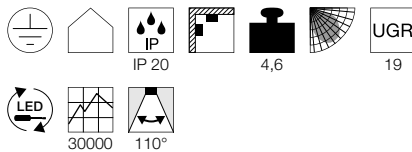
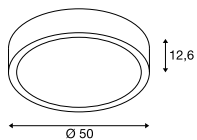
Maßzeichnung

Hinweis

Fernsteuerbar und dimmbar mit SLV VALETO® CCT/RGBW Fernbedienung [1002994] oder Gateway [1002411]

Zubehöreffempfung

- Abhängeset 1,5m Art. Nr. 135250
- Abhängeset 1,5m Art. Nr. 135251
- Abhängeset 1,5m Art. Nr. 135254
- Abhängeset 5m Art. Nr. 1001950
- Abhängeset 5m Art. Nr. 1001951
- Abhängeset 5m Art. Nr. 1001952
- Fernbedienung CCT/RGBW Art. Nr. 1002994

Variante	Art. Nr.
Ring: 350lm RGB+W (3000K) CRI>80 Panel: 2100-2400lm 2700-6500K CRI>80 □ weiß	1002858

Der dekorative **RING** ist separat steuerbar. Schaffen Sie ein stimmungsvolle Ambiente, indem Sie verschiedene Lichtfarben einstellen und das Licht dimmen.

Das **PANEL** ist separat steuerbar. Sie können die Farbtemperatur von 2700-6500K einstellen und das Licht dimmen.

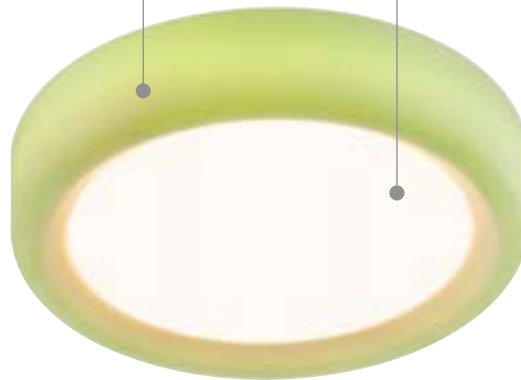

Mit unserem SLV VALETO® SMART LIGHT SYSTEM haben Sie die Wahl: Steuern Sie das Licht Zuhause mit unserer SLV VALETO® Fernbedienung (1002994), oder einer App auf Ihrem Smartphone über unser SLV VALETO® Gateway (1002411).

Dank des neuesten ZigBee Standards (ZigBee® 3.0) sind Ihnen bei Ihrer smarten Lichtsteuerung keine Grenzen gesetzt.



Fernbedienung
 Art. Nr. 1002994



Gateway
 Art. Nr. 1002411



SLV VALETO®
 App

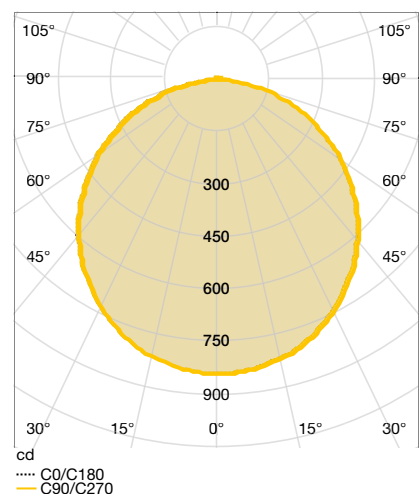
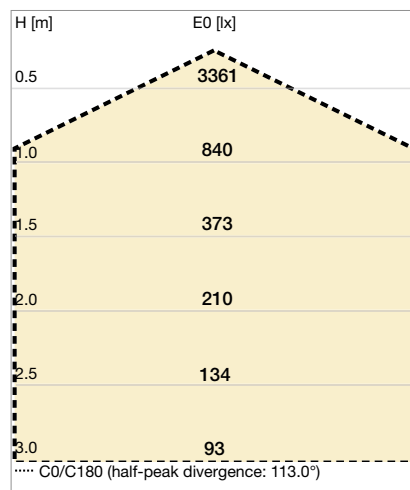



LIPSY®
CW, VALETO®

- Integrierbar in das VALETO® System

Produktangaben

230V ~50/60Hz
Systemleistung: 14,5W/17W/31,5W
Material: Polymethylacrylat (PMMA) / Stahl

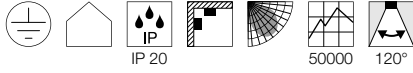

Hinweis

Fernsteuerbar und dimmbar mit SLV VALETO®
CCT/RGBW Fernbedienung [1002994] oder
Gateway [1002411]

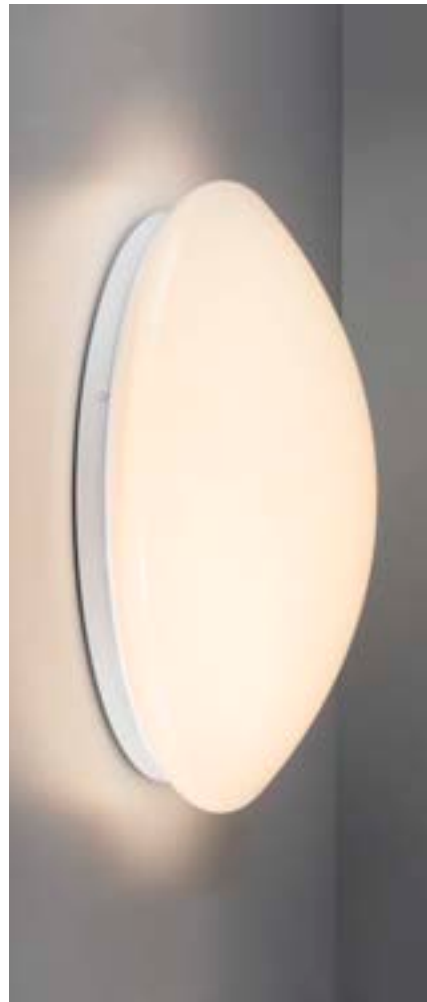

LIPSY® 30
CW, VALETO®



Maßzeichnung

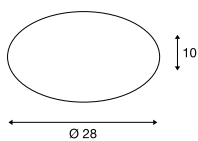

Variante	Art. Nr.
1400lm 3000K CRI>80 0,4 kg	
□ weiß	1002132

LIPSY® 40
CW, VALETO®



Maßzeichnung

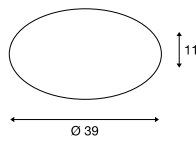

Variante	Art. Nr.
1700lm 3000K CRI>80 0,77 kg	
□ weiß	1002133

LIPSY® 50
CW, VALETO®



Maßzeichnung

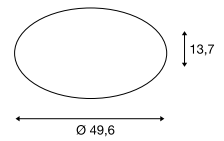

Variante	Art. Nr.
2800lm 3000K CRI>80 1,36 kg	
□ weiß	1002134

SO SIMPEL, SO CLEVER!

WEITERE SLV LICHTSTEUERUNGEN



SLV COLOR CONTROL

Bringen Sie Farbe in Ihr Leben! Mit dem **SLV COLOR CONTROL** System. Das ermöglicht das Ein- und Ausschalten von Leuchten sowie die farbliche Anpassung.

Dimmbarkeit, Farbsteuerung, Gruppierungsfunktion

Zubehör und Komponenten:

- App
- Fernbedienung
- Wandbedienpanel
- Master Controller + Fernbedienung
- Slave Controller
- Signal-Verstärker
- Bluetooth®-Adapter zur App-Steuerung
- Ansteuerbare Leuchten

Alle Infos ab Seite 828

SLV KELVIN CONTROL

Ganz schön helle: Mit **SLV KELVIN CONTROL** lassen sich Farbelligkeit und Farbtemperatur unabhängig voneinander steuern und an Ihre gewünschte Lichtsituation anpassen.

Dimmbarkeit, Farbtemperatursteuerung, Gruppierungsfunktion

Zubehör und Komponenten:

- App
- Fernbedienung
- Wandbedienpanel
- Master Controller + Fernbedienung
- Slave Controller
- Signal-Verstärker
- Bluetooth®-Adapter zur App-Steuerung
- Ansteuerbare Leuchten

Alle Infos ab Seite 832



SLV BLUETOOTH CONTROL

Klingt einfach blendend: Mit dem **SLV BLUETOOTH CONTROL** System können Sie Lichtinstallationen Ein- und Ausschalten sowie die Helligkeit steuern. Über die App können Lichtinstallationen gruppiert oder einzeln gesteuert werden.

Dimmbarkeit, Gruppierungsfunktion

Zubehör und Komponenten:

- App
- Dimming Modul

Alle Infos ab Seite 835



SLV CONTROL BY TRUST

Drahtlos statt ratlos: **SLV CONTROL BY TRUST** ist ein abgeschlossenes und umfangreiches Smart Home System zur drahtlosen Steuerung von Leuchten und anderen technischen Geräten.

Fernsteuerung (Internet), Dimmbarkeit, Zeitschaltfunktion, Gruppierungsfunktion

Zubehör und Komponenten:

- App
- Fernbedienung
- Internet Control Station
- Sensoren
- Steckdosen
- Signalverstärker

Alle Infos ab Seite 836



SLV COLOR CONTROL.

IHR KOMPLETTSYSTEM ZUR FARBLICHTSTEUERUNG.

Mit SLV COLOR CONTROL können Sie ganz nach Vorliebe das Farblicht Ihrer RGB/W-Geräte im Innenbereich individuell steuern. Über Funk, Wandbedienpanel oder mit der optionalen Bluetooth®-Erweiterung zur Steuerung via App.

Das System SLV COLOR CONTROL arbeitet nach dem Master-Slave-Prinzip und lässt sich jederzeit erweitern. Ihre Stimmung entscheidet: ob rotes, gelbes, blaues, grünes Licht oder eine dimmbare weiße Grundbeleuchtung.

SLV COLOR CONTROL bietet jede Menge Komfort. So lässt sich das System auf beliebig viele Räume in bis zu 3 unterschiedliche Farbzonen aufteilen und innerhalb von 15 m mit vielen Lichtquellen erweitern. Je nach Anwendung und Geschmack lässt sich die Farblichtsteuerung mit unseren SLV LIPSY Leuchten oder auch RGB/W LED-Strips realisieren.

IHR KOMPLETTSYSTEM ENTWEDER IN 2 ODER IN 3 SCHRITTEN:

SENDER



EMPFÄNGER



PRODUKT



SLV COLOR CONTROL

Wandbedienpanel, Einbau/Aufbau



Produktangaben

100-240V ~50/60Hz
 Leistung bis: 2W
 Produktmaße: L: 8,6 cm B: 8,6 cm H: 5 cm
 Einbaumaße: Ø: 5,5 cm, T: 4 cm
 Material: Kunststoff PC / Gla

Hinweis

Touchpanel mit Glasfrontplatte zum Ansteuern von Slave Controller [470672]. Reichweite des Touchpanels erhöhbar mit WLAN Signal-Verstärker [470674]; Sendefrequenz WLAN 2,4~2,48GHz; Reichweite ca. 15m abhängig von den lokalen Bedingungen. Bluetooth® Modul [470675] zur Bedienung per Smartphone/Tablet App nachrüstbar. 34 fest eingestellte Programme, 10 Geschwindigkeitsstufen, 30 fest eingestellte statische Farben, 5 Helligkeitsstufen für RGB, 10 Helligkeitsstufen für weiß. Optional steuerbar mit Fernbedienung [470677]. Zum Einbau in Schalterdosen mit einer Mindesttiefe von 40 mm geeignet. Zubehör/ Lieferumfang: Aufbaugehäuse [inkl.]

Leistung bis	2W
Umgebungstemp. min.	-30°C
Umgebungstemp. max.	50°C

Variante	Art. Nr.
<input type="checkbox"/> weiß	470670

SLV COLOR CONTROL

Fernbedienung



Produktangaben

Spannung prim.: Batteriebetrieb
 Produktmaße: L: 11,4 cm B: 5,6 cm H: 2,4 cm
 Material: Kunststoff P

Hinweis

Fernbedienung als optionale Bedienung für das RGBW Touch Controller Wall Panel [470670]; Ersatzfernbedienung für Master Controller [470671]; Sendefrequenz: 433,92MHz. Zubehör/ Lieferumfang: 2 Batterien AAA 1,5V [exkl.]

Umgebungstemp. min.	-30°C
Umgebungstemp. max.	50°C

Variante	Art. Nr.
<input type="checkbox"/> weiß	470677

SLV COLOR CONTROL

Master Controller mit Fernbedienung



Produktangaben

12V DC / 24V DC
 Leistung bis: 72/144W
 Produktmaße: L 8,6 cm B: 2,1 cm H: 0,9 cm
 Material: Kunststoff P

Hinweis

Master Controller mit Fernbedienung zum Anschluß von LED Strips 12-24VDC, erweiterbar mit Slave Controller [470672]. Reichweite des Controllers erhöhbar mit WLAN Sync. Signal-Verstärker [470674]; Sendefrequenz WLAN 2,4~2,48GHz; Reichweite ca. 15 m abhängig von den lokalen Bedingungen. Reichweite erweiterbar mit Repeater [470674]. 34 festeingestellte Programme, 30 festeingestellte statische Farben; 10 Geschwindigkeitsstufen, 5 Dimmstufen RGB, 10 Dimmstufen für weiß. Schutz gegen Verpolung, Überlast; Kurzschluss und Überhitzung. Zubehör/ Lieferumfang: Fernbedienung inkl. [L/B/H: 11,4/5,6/2,4], Zuleitungslänge: 12 cm, 2 Batterien AAA 1,5V [exkl.]

Spannung prim.	12V DC / 24V DC
Spannung sek.	12V DC / 24V DC
Leistung bis	72 /144W
Leistung pro Ausgang	18 / 36W
Umgebungstemp. min.	-30°C
Umgebungstemp. max.	50°C
Schutz im Fehlerfall	Temperatur Abschaltung
Anzahl Absicherung sek.	3
Anzahl Slave max.	unbegrenzt

Variante	Art. Nr.
<input type="checkbox"/> weiß	470671

SLV COLOR CONTROL

Slave Controller

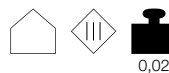

Produktangaben

12V DC / 24V DC
 Leistung bis: 72/144W
 Produktmaße: L 8,6 cm B: 2,1 cm H: 0,9 cm
 Material: Kunststoff P

Hinweis

Slave Controller zur Erweiterung der Master Controller [470670, 470671]; Empfangsfrequenz WLAN 2,4~2,48GHz; Schutz gegen Verpolung, Überlast; Kurzschluss und Überhitzung.

Spannung prim.	12V DC / 24V DC
Spannung sek.	12V DC / 24V DC
Leistung bis	72 /144W
Leistung pro Ausgang	18 / 36W
Umgebungstemp. min.	-30°C
Umgebungstemp. max.	50°C
Schutz im Fehlerfall	Temperatur Abschaltung
Anzahl Absicherung sek.	3

Variante	Art. Nr.
<input type="checkbox"/> weiß	470672

FLEXLED ROLL MULTICOLOUR RGBW, 24V



60 LEDs pro m
Breite/Höhe: 1,2/0,2 cm
LED-Abstand: 1,7 cm
Trennbar alle 10 cm
minimaler Biegeradius: 1,3 cm

3 m, CRI>80

Farbtemperatur	Leistung (W)	Farbwiedergabeindex (CRI)	Farbkonsistenz	Länge (cm)	Energieeffizienzklasse	Art. Nr.
RGBW	48	>80	6SDCM	300	A	552453

Um gleichbleibende Lichtleistung ab einer Länge von 1,5 m zu erhalten, empfehlen wir die Strips beidseitig einzuspeisen. Ab einer Länge von 3 m muss neu eingespeist werden.

ZUBEHÖR FLEXLED ROLL MULTICOLOUR RGBW, 24V



LED Netzteil, 20W



LED Netzteil, 60W

Variante	Strombelastung max.	Material	Länge (cm)	Breite (cm)	Höhe (cm)	Art. Nr.
<input type="checkbox"/> LED Netzteil	24V, 20W	Kunststoff P	16,7	3,8	3	470542
<input type="checkbox"/> LED Netzteil	24V, 60W	Kunststoff P	17,5	7,8	3,5	470506

SIGNALVERSTÄRKER



0,19

Produktangaben

100-240V ~50/60Hz
 L: 8 cm B: 8 cm H: 2 cm
 Material: Kunststoff P

Hinweis

Signal Verstärker zur Erhöhung der Reichweite des Wall Touch Panels [470670] und des Master Controllers [470671]/ Reichweite: Indoor 15 m Outdoor 30 m max., abhängig von den lokalen Bedingungen. Empfangs/ Sendefrequenz WLAN 2,4-2,48GHz. Schutz gegen Verpolung, Überlast; Kurzschluss und Überhitzung. Zubehör/ Lieferumfang: Netzteil inkl. [prim. 100-240V/50-60Hz, sek. 12Vdc/500mA]

Umgebungstemp. min. -30°C
 Umgebungstemp. max. 50°C

BLUETOOTH® ADAPTER



Hinweis

Optionales Bluetooth® Modul zum Einbau in das Wall Panel [470670] zur Bedienung über Smartphone oder Tablet mit Bluetooth® V2.1 oder höher; App iOS, Android stehen als Download zur Verfügung, Windows in Vorbereitung. Kommunikationsreichweite 10 m abhängig von den lokalen Bedingungen. Dieses Produkt findet ihr auch auf Seite 833.

Umgebungstemp. min. -30°C
 Umgebungstemp. max. 50°C

Variante	Art. Nr.
<input type="checkbox"/> weiß	470674

Variante	Art. Nr.
<input type="checkbox"/> weiß	470675





SLV KELVIN CONTROL.

SLV erfüllt vielfältige Anforderungen und Bedürfnisse an die moderne Lichtsteuerung. Mit SLV KELVIN CONTROL lassen sich Farbelligkeit und Farbtemperatur unabhängig voneinander steuern und an Ihre gewünschte Lichtsituation

anpassen. Sie entscheiden über die Art der Weißtöne, vom Tageslicht bis zum warmen Wohlfühlicht. Über Funk, Wandbedienpanel oder mit der optionalen Bluetooth®-Erweiterung zur Steuerung via App.

IHR KOMPLETTSYSTEM ENTWEDER IN 2 ODER IN 3 SCHRITTEN:

SENDER



EMPFÄNGER



PRODUKT



SLV KELVIN CONTROL

Wandbedienpanel, Einbau/Aufbau

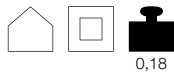

Produktangaben

100-240V ~50/60Hz
Leistung bis: 2W
Produkt: B: 8,6 cm H: 8,6 cm T: 5 cm
Einbau: Ø: 5,5 cm T: 4 cm
Material: Kunststoff P

Leistung bis	2W
Umgebungstemp. min.	-30°C
Umgebungstemp. max.	50°C

Variante	Art. Nr.
<input type="checkbox"/> weiß	470680

SLV KELVIN CONTROL

Fernbedienung



Produktangaben

Spannung prim.: Batteriebetrieb
L: 11,4 cm B: 5,6 cm H: 2,4 cm
Material: Kunststoff P

Umgebungstemp. min.	-30°C
Umgebungstemp. max.	50°C

Variante	Art. Nr.
<input type="checkbox"/> weiß	470683

SIGNALVERSTÄRKER

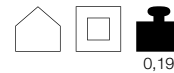

Produktangaben

100-240V ~50/60Hz
L: 8 cm B: 8 cm H: 2 cm
Material: Kunststoff P

Hinweis

Signal Verstärker zur Erhöhung der Reichweite des Wall Touch Panels [470670] und des Master Controllers [470671]/ Reichweite: Indoor 15 m Outdoor 30 m max., abhängig von den lokalen Bedingungen. Empfangs/ Sendefrequenz WLAN 2,4-2,48GHz. Schutz gegen Verpolung, Überlast; Kurzschluss und Überhitzung. Zubehör/ Lieferumfang: Netzteil inkl. [prim. 100-240V/50-60Hz, sek. 12Vdc/500mA].

Umgebungstemp. min.	-30°C
Umgebungstemp. max.	50°C

Variante	Art. Nr.
<input type="checkbox"/> weiß	470674

SLV KELVIN CONTROL

Master Controller mit Fernbedienung



Produktangaben

12V DC / 24V DC
Leistung bis: 72/144W
L: 8,6 cm B: 2,1 cm H: 0,9 cm
Material: Kunststoff P

Spannung prim.	12V DC / 24V DC
Spannung sek.	12V DC / 24V DC
Ausgangsstrom	6000mA
Anzahl Ausgänge sek.	2
Leistung bis	72/144W
Leistung pro Ausgang	36 / 72W
Umgebungstemp. min.	-30°C
Umgebungstemp. max.	50°C
Temperaturschutz	110°C
Schutz im Fehlerfall	Temperatur Abschaltung
Leitungs-L sek. max.	20m
Anzahl Absicherung sek.	2

Variante	Art. Nr.
<input type="checkbox"/> weiß	470681

SLV KELVIN CONTROL

Slave Controller



Produktangaben

12V DC / 24V DC
Leistung bis: 72/144W
L: 8,6 cm B: 2,1 cm H: 0,9 cm
Material: Kunststoff P

Spannung prim.	12V DC / 24V DC
Spannung sek.	12V DC / 24V DC
Ausgangsstrom	6000 mA
Anzahl Ausgänge sek.	2
Leistung bis	72/144W
Leistung pro Ausgang	36 / 72W
Umgebungstemp. min.	-30°C
Umgebungstemp. max.	50°C
Temperaturschutz	110°C
Schutz im Fehlerfall	Temperatur Abschaltung
Leitungs-L sek. max.	20m
Anzahl Absicherung sek.	2

Variante	Art. Nr.
<input type="checkbox"/> weiß	470682

BLUETOOTH® ADAPTER



Hinweis

Optionales Bluetooth® Modul zum Einbau in das Wall Panel [470670] zur Bedienung über Smartphone oder Tablet mit Bluetooth V2.1 oder höher; App iOS, Android stehen als Download zur Verfügung, Windows in Vorbereitung. Kommunikationsreichweite 10m abhängig von den lokalen Bedingungen.

Umgebungstemp. min.	-30°C
Umgebungstemp. max.	50°C

Variante	Art. Nr.
<input type="checkbox"/> weiß	470675

KELVIN CONTROL-STRIP, 24V



240 LEDs pro m
 Breite/Höhe: 1/0,2 cm
 Trennbar alle 5 cm
 minimaler Biegeradius: 3,8 cm
 Passend zum Kelvin Control System
 Lichtfarbe von 2700K-6500K einstellbar

3 m, CRI>80

Farbtemperatur	Lichtstrom (lm)	Leistung (W)	Farbwiedergabeindex (CRI)	Farbkonsistenz	Länge (cm)	Energieeffizienzklasse	Art. Nr.
2700K-6500K	1881 – 3921	18 – 36	>80	3SDCM	300	A+	552863
2700K-6500K	3522 – 7230	37,5 – 75				A	552883

Um gleichbleibende Lichtleistung ab einer Länge von 1,5 m zu erhalten, empfehlen wir die Strips beidseitig einzuspeisen.
 Ab einer Länge von 3 m muss neu eingespeist werden.

ZUBEHÖR KELVIN CONTROL-STRIP, 24V



LED Netzteil, 36W



LED Netzteil, 100W

Variante	Strombelastung max.	Material	Länge (cm)	Breite (cm)	Höhe (cm)	Art. Nr.
■ LED Netzteil	24V, 36W	Kunststoff P	12,9	7,5	3,2	470544
■ LED Netzteil	24V, 100W	Kunststoff P	18,5	8,8	3,5	470500

2700K

3000K

4000K



SLV BLUETOOTH® CONTROL

Fortschrittliche drahtlose Lichtregelung einfach und überall basierend auf Bluetooth® Low Energy (BLE). Das SLV BLUETOOTH® CONTROL Lösung ermöglicht das Ein- und Ausschalten von Lichtinstallationen und die Helligkeitssteuerung. Durch die App können Lichtinstallationen gruppiert oder einzeln gesteuert werden.



SLV BLUETOOTH® Wandebau Dimmer, TRIAC



Produktangaben

220-240V ~50/60Hz
Leistung: 300W
Dimmbar: Triac C, Triac L
L: 4,5 cm B: 4,5 cm H: 2,2 cm
Material: Kunststoff P

Hinweis

Als unabhängiger Dimmer ohne Bluetooth nutzbar. Dimmverfahren: Phasenabschnitt. Dimmer für ohmsche (Hochvolt Halogen Leuchtmittel) und kapazitive Lasten (LED Treiber). Passend für jede 60mm UP-Schalterdose mit einer Tiefe von 42mm. Geringe Mindestlast von 2W.

Spannung prim.	220-240V ~50/60Hz
Spannung sek.	220-240VAC
Ausgangsstrom	1,31 mA
Anzahl Ausgänge sek.	1
Leistung	300W
Leistung von	2W
Leistung bis	300W
Leistung/Ausgang	300W
Umgebungstemp. max.	40°C
Schutz im Fehlerfall	elektronisch

Variante	Art. Nr.
<input type="checkbox"/> weiß	1000826





SLV CONTROL BY TRUST.

MAXIMALE FLEXIBILITÄT.

Licht oder Jalousien ganz bequem fernbedienen? Schalter nachträglich dort platzieren, wo immer sie gebraucht werden? Und sogar weitere Geräte in das System einbinden? Und das ohne Wände aufzustemmen und neue Stromkabel zu verlegen? Alles machbar: mit unserer Lösung, die ihre Vorteile besonders bei der Modernisierung der eigenen vier Wände ausspielt.

Übrigens: Alle Sender arbeiten mit Funksignalen (433/866 MHz), die speziell für unsere Empfänger codiert sind. Andere Funkgeräte – wie z.B. Modems, Telefone oder Babyphone-Überwachungsgeräte – verwenden eine andere Codierung und/oder eine andere Frequenz. Warum das wichtig ist? Weil so verhindert wird, dass sich unsere Empfänger unvermittelt ein- oder ausschalten.

MEHR KOMFORT IN 3 EINFACHEN SCHRITTEN:

SENDER



EMPFÄNGER

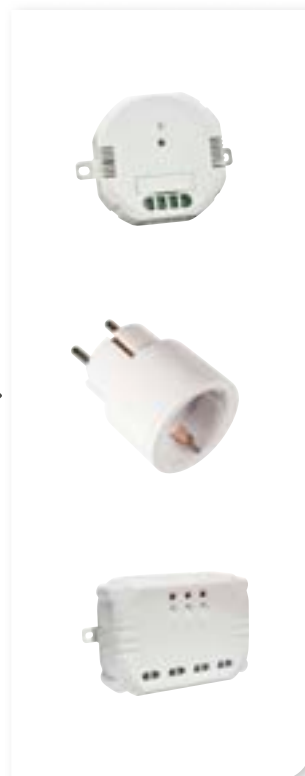

PRODUKT

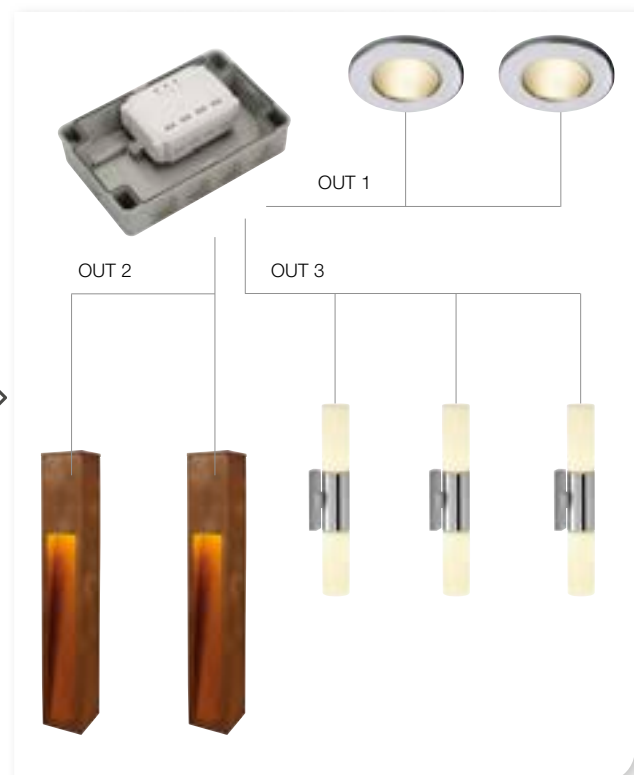

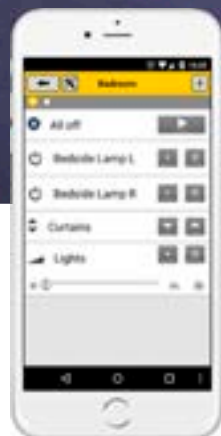

STEUERUNG VON LICHT, JALOUSIEN UND VIELEM MEHR.

MEHR MÖGLICHKEITEN – Unsere Sender und Empfänger lassen sich beliebig kombinieren und bieten so vielfältige Einsatzmöglichkeiten. Vorteil: Über eine Funksteckdose lassen sich auch mobile Leuchten via Funkfernbedienung ganz bequem steuern. Unser Funksystem SLV CONTROL BY TRUST kann jederzeit um weitere Komponenten erweitert werden.

MEHR KOMFORT – Schalten oder dimmen von wo auch Sie immer wollen, ob zuhause oder von unterwegs – mit SLV CONTROL BY TRUST geht das denkbar einfach. Zum Beispiel via Fernbedienung oder auch mit unserer App und Internet Control Station über Smartphone, Tablet oder per Internet Browser vom PC aus.

MEHR SICHERHEIT – Beleuchtung automatisch einschalten lassen, ohne einen Schalter betätigen zu müssen? Zum Beispiel beim Betreten der Keller-treppe oder abends auf dem Weg von der Garage zur Haustür. Mit unseren Funk-Bewegungsmeldern kein Problem. Weiteres Sicherheits-Plus unserer Funklösung: Über Zeitschaltuhren lässt sich auch Anwesenheit simulieren und Einbrecher abschrecken.

SENDER

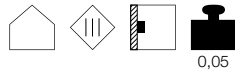
SLV CONTROL BY TRUST
Wandschalter 1-Fach

Produktangaben

Spannung prim.: Batteriebetrieb
B: 7,9 cm H: 8 cm T: 1,7 cm
Material: Kunststoff

Hinweis

Batterie CR2032 [inkl.] Ausschaltverzögerung:
5s, 30s, 2min, 10min, 30min, 1h, 3h oder
Dauerbetrieb/manuelles Ein- und Ausschalten.
Können auf glatten Flächen befestigt oder
aufgeklebt werden.

RF-Bereich max. (Indoor)	30,0 m
RF-Frequenz	433,92 MHz

Variante	Art. Nr.
<input type="checkbox"/> weiß	470812

SLV CONTROL BY TRUST
Fernbedienung 16 Kanal

Produktangaben

Spannung prim.: Batteriebetrieb
L: 13 cm B: 3,4 cm H: 1,2 cm
Material: Kunststoff

Hinweis

1x 3V Lithium-Batterie CR2032 [inkl.].
Automatisches Code-System. 16 Kanäle
mit Gruppen-Funktion. Zur Ansteuerung
der Empfängermodule.

RF-Bereich max. (Indoor)	30,0 m
RF-Frequenz	433,92 MHz

Variante	Art. Nr.
<input type="checkbox"/> weiß	470800

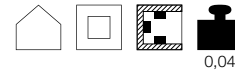
SLV CONTROL BY TRUST
Internet Controlstation ICS 2000

Produktangaben

100-240V ~50/60Hz
B: 12,7 cm H: 12,6 cm T: 3,3 cm
Material: Kunststoff

Hinweis

Mit der kostenlosen SLV App für iOS oder
Android lassen sich alle einprogrammierten
Lichtszene/-quellen/-kreise bequem und
kabellos ansteuern. Die App für iOS oder Android
erhalten Sie kostenlos im Apple/ Google Play
Store. Auch über Internetbrowser bedienbar. Für
einzelne Leuchten und/ oder Lichtsequenzen
können verschiedene Timer programmiert werden.
Bedienung von mehr als 200 unabhängigen
Lampen und Geräten in bis zu 16 Räumen. Er-
stellen Sie Zeitschaltintervalle zum automatischen
Schalten der Leuchten oder Geräte. Erstellen Sie
Sequenzen, mit denen Sie mit nur einer Taste
mehrere Lampen oder Geräte in einer bestimmten
Reihenfolge schalten können. Sonnenaufgang-/
Untergang-Funktion. Mehrere Tablets/Smart-
phones können mit der Internet Controlstation
verbunden werden. Inklusiv Netzteil und Netz-
werkkabel.

RF-Bereich max.	30,0 m	70,0 m
(Indoor)		
RF-Frequenz	433,92 MHz	868 MHz

Variante	Art. Nr.
<input checked="" type="checkbox"/> schwarz	1001153



Sender



Empfänger S. 839-840



Produkt

EMPFÄNGER

SLV CONTROL BY TRUST Funk-Steckdosenschalter Indoor



Produktangaben

220-240V ~50/60Hz
Ø: 4,78 cm H: 7 cm
Material: PC

Hinweis

Bis zu 32 Funksender können angelernt werden.

RF-Bereich max. (Indoor)	30,0 m
RF-Frequenz	433,92 MHz

Variante	Art. Nr.
<input type="checkbox"/> weiß	1002409

SLV CONTROL BY TRUST Funk-Steckdosenschalter Outdoor

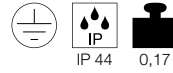

Produktangaben

220-240V ~50/60Hz
Leistung bis: 3500W
L: 12,3 cm B: 8,3 cm H: 3,7 cm
Material: Kunststoff

Hinweis

Bis zu 6 Funksender können angelernt werden.

RF-Bereich max. (Indoor)	30,0 m
RF-Bereich max. (Outdoor)	70,0 m
RF-Frequenz	433,92 MHz

Variante	Art. Nr.
<input checked="" type="checkbox"/> schwarz	470808

SLV CONTROL BY TRUST Funk-Steckdosenschalter UK

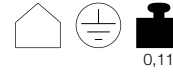

Produktangaben

220-240V ~50/60Hz
Leistung bis: 3000W
L: 5,3 cm B: 9,8 cm H: 5,3 cm
Material: PVC

Hinweis

Bis zu 6 Funksender können angelernt werden.

RF-Bereich max. (Indoor)	30,0 m
RF-Frequenz	433,92 MHz

Variante	Art. Nr.
<input type="checkbox"/> weiß	470821

SLV CONTROL BY TRUST Funk-Steckdosenschalter IT



Produktangaben

220-240V ~50/60Hz
Leistung bis: 1000W
B: 5,3 cm H: 9,8 cm T: 7 cm
Material: PVC

Hinweis

Bis zu 6 Funksender können angelernt werden.

RF-Bereich max. (Indoor)	30,0 m
RF-Frequenz	433,92 MHz

Variante	Art. Nr.
<input type="checkbox"/> weiß	470822

SLV CONTROL BY TRUST Funk-Steckdosenschalter BE/FR Indoor

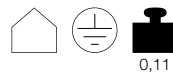

Produktangaben

220-240V ~50/60Hz
Leistung bis: 1000W
B: 5,3 cm H: 9,8 cm T: 6,6 cm
Material: PVC

Hinweis

Bis zu 6 Funksender können angelernt werden.

RF-Bereich max. (Indoor)	30,0 m
RF-Frequenz	433,92 MHz

Variante	Art. Nr.
<input type="checkbox"/> weiß	470823

SLV CONTROL BY TRUST Funk-Steckdosenschalter BE/FR Outdoor



Produktangaben

220-240V ~50/60Hz
Leistung bis: 3500W
B: 6 cm H: 12,2 cm H: 7,3 cm
Material: PVC

Hinweis

Bis zu 6 Funksender können angelernt werden.

RF-Bereich max. (Indoor)	30,0 m
RF-Bereich max. (Outdoor)	70,0 m
RF-Frequenz	433,92 MHz

Variante	Art. Nr.
<input checked="" type="checkbox"/> schwarz	470824

> Sender S. 838



Empfänger

> Produkt

EMPFÄNGER

SLV CONTROL BY TRUST Funk-Multidimmer-Einbau

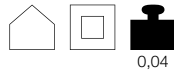

0,04

Produktangaben

220-240V ~50/60Hz
Leistung bis: 200W
B: 6,9 cm H: 5,4 cm T: 2,9 cm
Material: Kunststoff

Hinweis

Bis zu 6 Funksender können angelernt werden. Kompatibel mit Glühlampen, Halogenlampen, Kompaktleuchtstofflampen und LED-Lampe. Nicht kompatibel mit Leuchtstofföhren mit konventionellen Vorschaltgeräten. Bei Halogenlampen nur ein Transformator pro Empfänger.

Anzahl Ausgänge sek.	1
Leistung bis	200W
RF-Bereich max. (Indoor)	30,0 m
RF-Frequenz	433,92 MHz

Variante	Art. Nr.
<input type="checkbox"/> weiß	470807

SLV CONTROL BY TRUST Funk-Einbauschalter

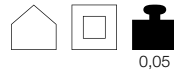

0,05

Produktangaben

220-240V ~50/60Hz
Leistung bis: 1000W
B: 6,8 cm H: 5,3 cm T: 2,5 cm
Material: Kunststoff

Hinweis

Bis zu 6 Funksender können angelernt werden. Kompatibel mit Glühlampen, Halogenlampen, Kompaktleuchtstofflampen, LED-Lampen und Leuchtstofföhren mit elektronischen Vorschaltgeräten. Nicht kompatibel mit Leuchtstofföhren mit konventionellen Vorschaltgeräten.

Anzahl Ausgänge sek.	1
Leistung bis	1000W
RF-Bereich max. (Indoor)	30,0 m
RF-Frequenz	433,92 MHz

Variante	Art. Nr.
<input type="checkbox"/> weiß	470806

SLV CONTROL BY TRUST Funk-Empfängermodul, 3 Kanal

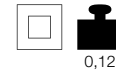

0,12

Produktangaben

220-240V ~50/60Hz
Leistung bis: 3500W
L: 9,8 cm B: 3 cm H: 6,1 cm
Material: Kunststoff

Hinweis

Funkreichweite bis zu 30 m im Innenbereich (abhängig von lokalen Bedingungen). Funkreichweite bis zu 70 m im Außenbereich (bei optimalen Bedingungen). Bis zu 6 Funksender können pro Kanal angelernt werden. Kompatibel mit Glühlampen, Halogenlampen, Kompaktleuchtstofflampen, LED-Lampen und Leuchtstofföhren mit elektronischen Vorschaltgeräten. Nicht kompatibel mit Leuchtstofföhren mit konventionellen Vorschaltgeräten.

Anzahl Ausgänge sek.	3
Leistung bis	3500W
RF-Bereich max. (Indoor)	30,0 m
RF-Frequenz	433,92 MHz

Variante	Art. Nr.
<input type="checkbox"/> weiß	470803

SLV CONTROL BY TRUST IP56 Anschlussgehäuse, 3 Kanal

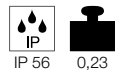

IP 56 0,23

Produktangaben

L: 16,4 cm B: 4,8 cm H: 10,9 cm
Material: Kunststoff

Hinweis

Schrauben [inkl.], 4 Kabelverschraubungen [inkl.]
Zur IP-geschützten Installation des Empfängers [470803] im Außenbereich.

Variante	Art. Nr.
<input type="checkbox"/> grau	470804

> Sender S. 838



Empfänger

> Produkt



147326 304

228965 540

233650 701

IN STRAHLENDER BEGLEITUNG.

ZUBEHÖR FÜR INDIVIDUELLE LICHTÄSTHETIK.

Licht hat viele Facetten. Und genauso vielfältig sind die Möglichkeiten, wenn es um die Beleuchtung von Räumen und Außenbereichen geht. Mit unserem Zubehör können diese Möglichkeiten noch erweitert und Umgebungen durch unterschiedliche Lichtinstallationen buchstäblich in ein neues Licht getaucht werden.

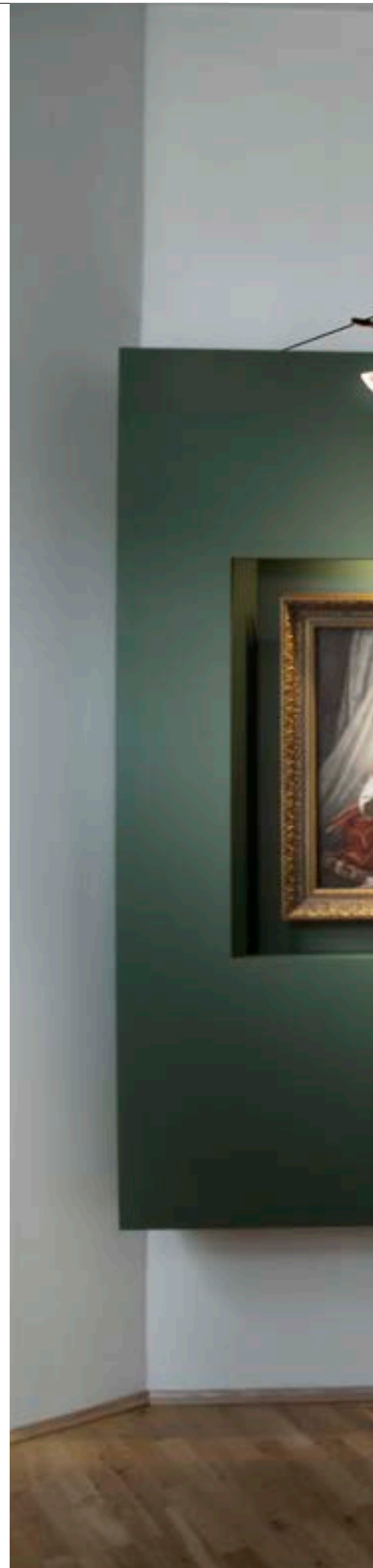



139100 421

FIND A DIMMER. GUT KOMBINIERT.

STIMMUNGSVOLLE RAUMBELEUCHTUNG DANK DER PERFEKTEN KOMBINATION AUS LEUCHTE UND DIMMER. **UNTER [FIND-A-DIMMER.SLV.COM](https://www.find-a-dimme.slv.com)**

Beim Dimmen muss auf die Kompatibilität von Leuchten bzw. Leuchtmitteln und Dimmer geachtet werden. Und gerade bei LED Leuchtmitteln ist vorher zu prüfen, welcher Dimmer benötigt wird. Angesichts der vielen verschiedenen Produkte ist es nicht immer einfach, die optimale Kombination zu finden. Unsere „Find a Dimmer“ Übersicht soll Ihnen dabei helfen. Neben einer Vielzahl von Kombinationen aus dimmbaren Leuchten bzw. Leuchtmitteln und Dimmern, finden Sie unter

find-a-dimme .slv.com auch weitere Informationen zur Mindestanzahl der für einen einwandfreien Betrieb benötigten Leuchten bzw. Leuchtmittel. **Die Übersicht wird regelmäßig aktualisiert und erweitert.**

Bei speziellen Anfragen kontaktieren Sie unseren techn. Support unter **service@slv.de**.



1 Geeignet

- Ideales Dimmverhalten
- Die Mindestanzahl der für einen einwandfreien Betrieb benötigten Leuchten/Leuchtmittel ist als Zahl angegeben.

1 Nur bedingt geeignet

- kein optimales Dimmverhalten
- Flackern möglich

X Nicht kompatibel



[find-a-dimme .slv.com](https://www.find-a-dimme.slv.com)



ZUBEHÖR

Transformatoren
12V AC

846

Transformatoren IP44
12V AC

846

**TENSEO
Transformatoren**
12V AC

847

Transformatoren
12V AC

848

Transformatoren
12V AC

848

Strip Steuermodul
VALETO®

848

DALI Interface
0-10V

849

**DALI Universal
Dimmer**

849

DALI Controller

849

PWM-Wandler

849

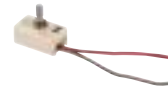
1-10V Dimmer

849

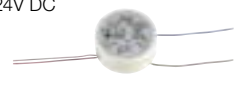
LED Netzteile
12V/24V DC

850

LED Netzteile
24V DC

850

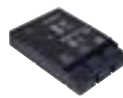
LED Netzteile
24V DC

851

**Kompensations-
modul**

852

LED Treiber
dimmbar

852-853

LED Treiber
VALETO®

853

LED Treiber
DALI dimmbar

854-855

LED Treiber
nicht dimmbar

856-857

Deckenhaken

858

Kabelklemme

858

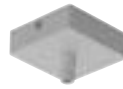
Deckenrosetten

859

Textilkabel
5 m

859

Textilkabel
10 m

859

Kabel
10 m klar

859

**Drahtseil-
abhängung**

859

Stopper
für Drahtseil

859

Steckerleiste
3 Ausgänge
6 Ausgänge

860-861

Fassung
GU10

860

**Kabelver-
längerungen**
1 m
2 m

860-861

Fassung
GU10

860

**Rohrkitt Nepro
Display**

861

**Doppelseitiges
Klebeband**

861

**Garten-
steckdosen**
Länderspez.
1,5 m

862

**Garten-
steckdosen**
Länderspez.
10 m

863

Energie-Pack

864

**Verbindungs-
boxen**

864

**T-Verbinde-
boxen**

864-865

SLV Kabel

865

**Bewegungs-
melder**
Infrarot

865

Weiteres Zubehör finden Sie online unter www.slv.com

TRANSFORMATOR

12V AC | 105VA



Produktangaben

230V ~50Hz
L: 11 cm B: 7,5 cm H: 8 cm
Dimmbar: L

Spannung sek.	12V AC
Anzahl Ausgänge sek.	1
Nennleistung VA	105
Leistung bis	105W
Temperaturschutz	110°C

Variante	Art. Nr.
<input type="checkbox"/> weiß	451105

TRANSFORMATOR

12V AC | 300VA



Produktangaben

230V ~50Hz
L: 9 cm B: 13 cm H: 11 cm
Dimmbar: L

Spannung sek.	12V AC
Anzahl Ausgänge sek.	1
Nennleistung VA	300
Leistung bis	300W
Temperaturschutz	110°C

Variante	Art. Nr.
<input type="checkbox"/> weiß	451301

TRANSFORMATOR

12V AC | 10VA IP44



Produktangaben

230V ~50Hz
Material: Kunststoff
L: 7,5 cm B: 5 cm H: 4,5 cm
Dimmbar: L

Spannung sek.	12V AC
Anzahl Ausgänge sek.	1
Nennleistung VA	10
Leistung bis	10W
Temperaturschutz	133°C

Variante	Art. Nr.
<input checked="" type="checkbox"/> schwarz	227140

TRANSFORMATOR

12V AC | 60VA IP44

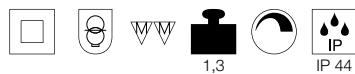

Produktangaben

230V ~50Hz
Material: Kunststoff
L: 6 cm B: 10 cm H: 6,3 cm
Dimmbar: L

Spannung sek.	12V AC
Anzahl Ausgänge sek.	1
Nennleistung VA	60
Leistung bis	60W
Temperaturschutz	133°C

Variante	Art. Nr.
<input checked="" type="checkbox"/> schwarz	227160

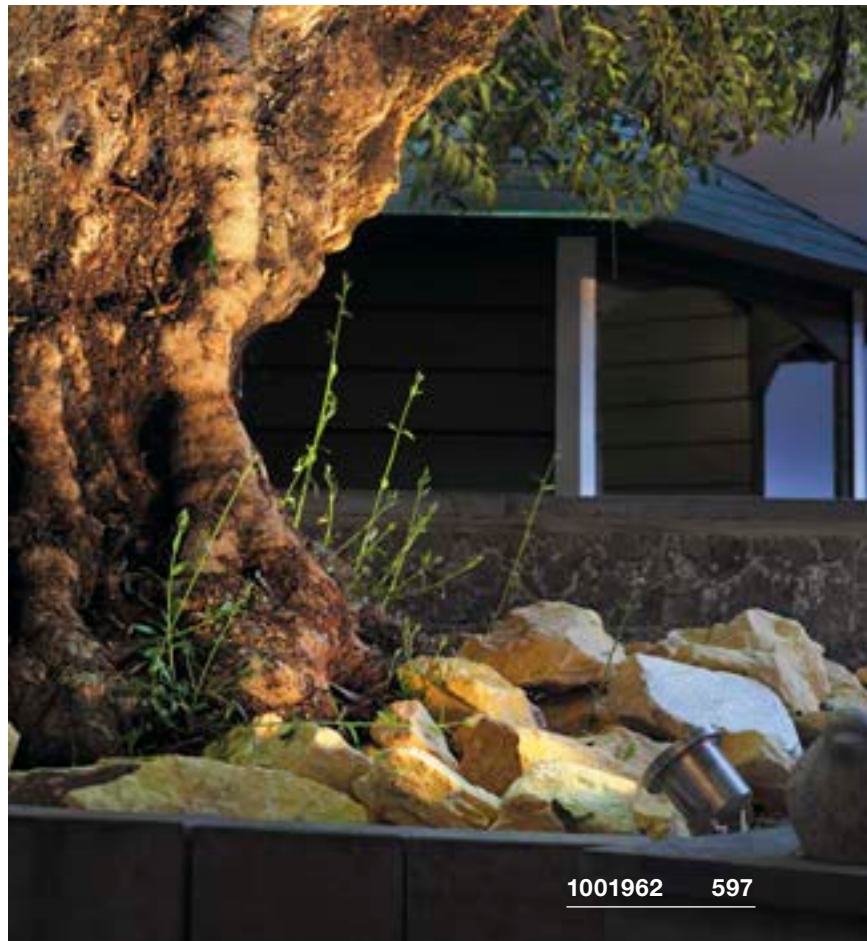

1001962 597

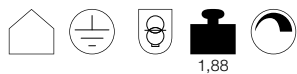
TRANSFORMATOR TENSEO
 12V AC | 50VA

Produktangaben

230V ~50Hz
 Material: Stahl/Messing
 Ø: 11,1 cm H: 11 cm
Dimmbar: L

Spannung sek.	12V AC
Anzahl Ausgänge sek.	1
Nennleistung VA	50
Leistung bis	50W
Temperaturschutz	130°C
Absicherung prim.	1,6A

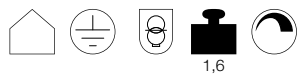
Variante	Art. Nr.
■ schwarz	1002691
□ weiß	1002692
■ chrom	1002693

TRANSFORMATOR TENSEO
 12V AC | 105VA

Produktangaben

230V ~50Hz
 Material: Stahl/Messing
 Ø: 11 cm H: 11 cm
Dimmbar: L

Spannung sek.	12V AC
Anzahl Ausgänge sek.	1
Nennleistung VA	105
Leistung bis	105W
Temperaturschutz	130°C
Absicherung prim.	1,6A

Variante	Art. Nr.
■ schwarz	138980
□ weiß	138981
■ chrom	138982

TRANSFORMATOR TENSEO
 12V AC | 210VA

Produktangaben

230V ~50Hz
 Material: Stahl/Messing
 Ø: 13,5 cm H: 11 cm
Dimmbar: L

Spannung sek.	12V AC
Anzahl Ausgänge sek.	1
Nennleistung VA	210
Leistung bis	210W
Temperaturschutz	130°C
Absicherung prim.	3,15A

Variante	Art. Nr.
■ schwarz	138990
□ weiß	138991
■ chrom	138992

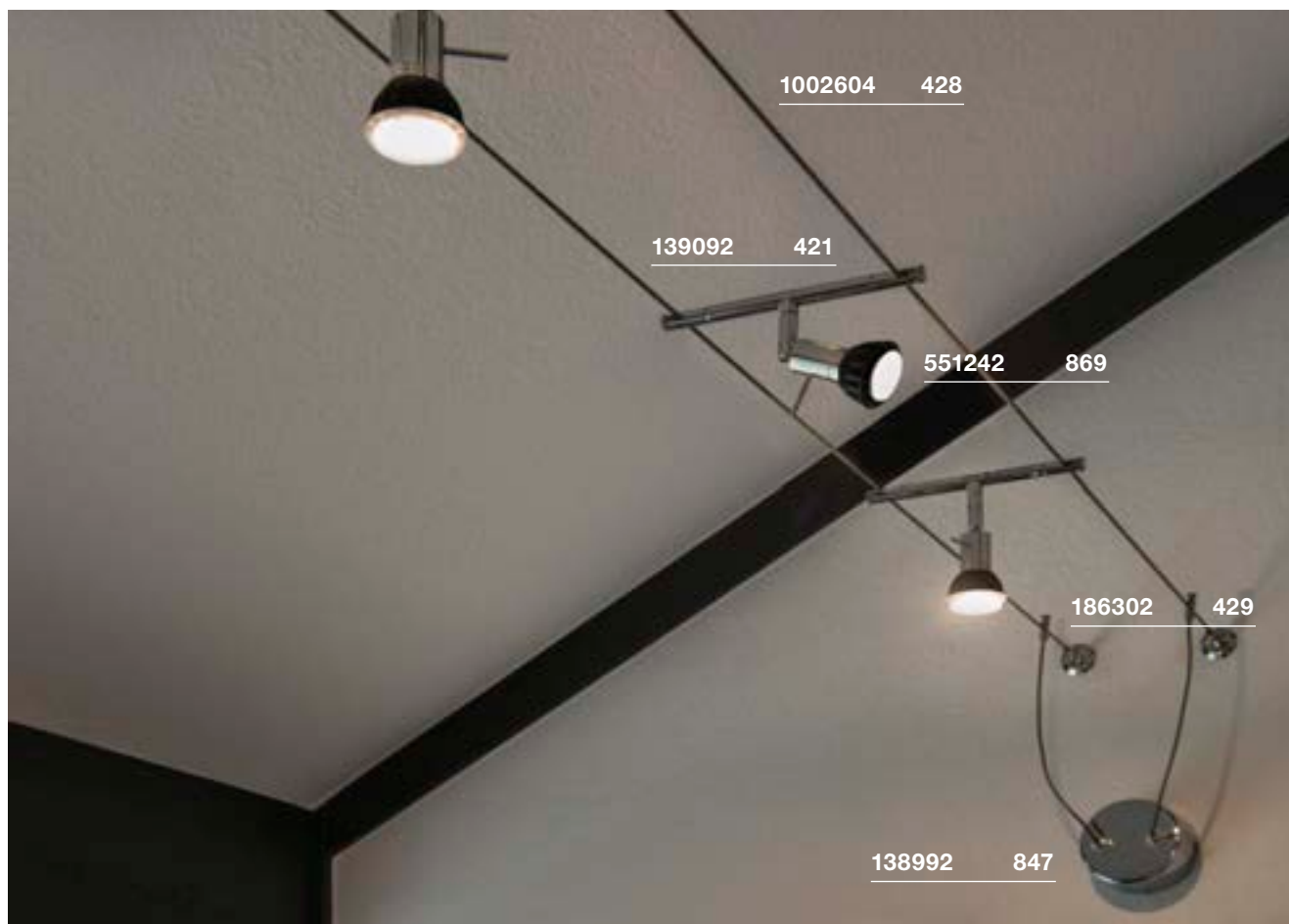

TRANSFORMATOR 12V AC | 60VA

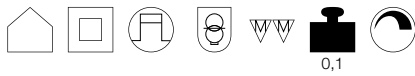

0,1

Produktangaben

230V ~50Hz
Material: Kunststoff P
Ø: 5,5 cm T: 2,3 cm
Dimmbar: C

Spannung sek.	12V AC
Anzahl Ausgänge sek.	1
Leistung von	10W
Leistung bis	70W
Leistungsfaktor	0,98
Temperaturschutz	110°C

Variante	Art. Nr.
<input type="checkbox"/> weiß	461050

TRANSFORMATOR 12V AC | 60VA

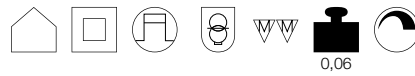

0,06

Produktangaben

230V ~50Hz
Material: Kunststoff P
L: 10,5 cm B: 3,3 cm H: 2,2 cm
Dimmbar: C

Spannung sek.	12V AC
Anzahl Ausgänge sek.	1
Leistung von	10W
Leistung bis	60W
Leistungsfaktor	0,98
Temperaturschutz	110°C

Variante	Art. Nr.
<input type="checkbox"/> weiß	461060

TRANSFORMATOR 12V AC | 150VA

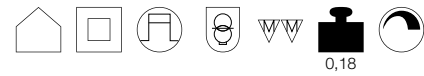

0,18

Produktangaben

230V ~50Hz
Material: Kunststoff
L: 16,6 cm B: 3,9 cm H: 3,3 cm
Dimmbar: C

Spannung sek.	12V AC
Anzahl Ausgänge sek.	3
Leistung von	50W
Leistung bis	150W
Temperaturschutz	110°C
Absicherung prim.	3,15A

Variante	Art. Nr.
<input checked="" type="checkbox"/> schwarz	461157

TRANSFORMATOR 12V AC | 210VA



0,29

Produktangaben

230V ~50Hz
Material: Kunststoff
L: 20 cm B: 4,3 cm H: 3,9 cm
Dimmbar: C

Spannung sek.	12V AC
Anzahl Ausgänge sek.	3
Leistung von	50W
Leistung bis	210W
Temperaturschutz	110°C
Absicherung prim.	3,15A

Variante	Art. Nr.
<input checked="" type="checkbox"/> schwarz	461217

SLV VALETO® 12/24V Strip Steuermodul | CCT

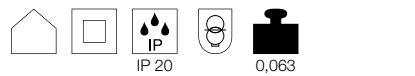

IP 20

0,063

Produktangaben

12V/24V DC
Leistung: max. 192W pro Kanal
L: 13,4 cm B: 3,9 cm H: 2,4 cm
Material: Kunststoff

Hinweis

Fernsteuerbar und dimmbar mit SLV VALETO® CCT/RGBW Fernbedienung [1002994] oder Gateway [1002411]. Das Steuermodul ist dazu geeignet CCT LED Strips zu steuern.

Ausgangsspannung	12/24V
Anzahl Ausgänge sek.	2
Leistung von	1W
Leistung bis	192W
Umgebungstemp. min.	-30°C
Umgebungstemp. max.	60°C
Schutz im Fehlerfall	elektronisch

Variante	Art. Nr.
<input type="checkbox"/> weiß	1001859

SLV VALETO® 12/24V Strip Steuermodul | RGBW

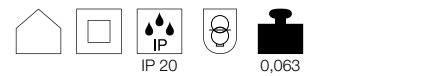

IP 20

0,063

Produktangaben

12V/24V DC
Leistung: max. 96W pro Kanal
L: 13,4 cm B: 3,9 cm H: 2,4 cm
Material: Kunststoff

Hinweis

Fernsteuerbar und dimmbar mit SLV VALETO® CCT/RGBW Fernbedienung [1002994] oder Gateway [1002411]. Das Steuermodul ist dazu geeignet RGBW LED Strips zu steuern.

Ausgangsspannung	12/24V
Anzahl Ausgänge sek.	4
Leistung von	1W
Leistung bis	96W
Umgebungstemp. min.	-30°C
Umgebungstemp. max.	60°C
Schutz im Fehlerfall	elektronisch

Variante	Art. Nr.
<input type="checkbox"/> weiß	1002892

DALI INTERFACE 0-10V + on/off

NEW



0,02

Produktangaben

220-240V ~50/60Hz
Material: Kunststoff
L: 5,85 cm B: 3,25 cm H: 1,5 cm

Hinweis

Zum Ansteuern von elektronischen Vorschaltgeräten mit 1-10V Steuereingang. Schaltrelais zum zusätzlichen Ein/Ausschalten der EVG-Leistungsversorgung. Galvanische Trennung von DALI-Eingang und 1-10V Ausgang

Leistung bis 1000W

Variante	Art. Nr.
	1002218

DALI UNIVERSAL DIMMER 3-25W

NEW

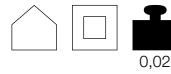

0,02

Produktangaben

220-240V ~50/60Hz
Material: Kunststoff
L: 5,85 cm B: 3,25 cm H: 1,5 cm

Hinweis

Geeignet für R, L, C-Last dank automatischer Lasterkennung. DALI Stromaufnahme: 6mA

Leistung von 3W
Leistung bis 25W

Variante	Art. Nr.
	1002220

DALI UNIVERSAL DIMMER 10-300W

NEW

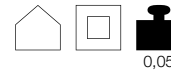

0,05

Produktangaben

220-240V ~50/60Hz
Material: Kunststoff
L: 12,02 cm B: 3,02 cm H: 2,16 cm

Hinweis

Geeignet für R, L, C-Last dank automatischer Lasterkennung. DALI Stromaufnahme: 6mA

Leistung von 10W
Leistung bis 300W

Variante	Art. Nr.
	1002221

DALI CONTROLLER 24V DC

NEW



0,051

Produktangaben

10-24V DC
Material: Kunststoff P
L: 11,6 cm B: 4,2 cm H: 1,8 cm

Hinweis

Geeignet zur Steuerung von LED mit einer Konstantspannung von 10-24V / DC – Steuer-signal DALI oder Push-Dim

Variante	Art. Nr.
weiß/grau	1003106

PWM-WANDLER 12V DC / 24V DC



0,1

Produktangaben

12V DC / 24V DC
Material: Kunststoff P
L: 17 cm B: 4 cm H: 3 cm

Hinweis

1 Kanal PWM-Steller zur Dimmung von LED die mit einer Konstantspannung 12V/DC – 24V/DC betrieben werden. Steuersignal 1-10V

Spannung sek. 12V DC / 24V DC
Anzahl Ausgänge sek. 1
Leistung bis 50 / 100W

Variante	Art. Nr.
weiß	470550

1-10V DIMMER 10W

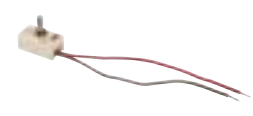

0,04

Produktangaben

10W
Material: Kunststoff P
L: 2,3 cm B: 3,9 cm H: 2 cm

Hinweis

Geeignet zum Dimmen von 1-10V Vorschaltgeräten

Variante	Art. Nr.
weiß	470505

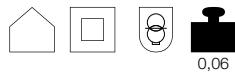
LED NETZTEIL
 12V/24V DC | 12W rund

Produktangaben

100-240V ~50/60Hz
 Material: Kunststoff P
 Ø: 5,5 cm H: 2,2 cm

Spannung sek.	12V/24V DC
Anzahl Ausgänge sek.	1
Nennleistung VA	12
Leistung bis	12W
Temperaturschutz	110°C

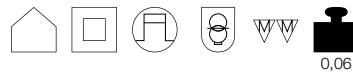
Variante	Art. Nr.
12V	470545
24V	470546

LED NETZTEIL
 12V/24V DC | 12W

Produktangaben

220-240V ~50/60Hz
 Material: Kunststoff P
 L: 8,5 cm B: 4 cm H: 2,2 cm

Spannung sek.	12V/24V DC
Anzahl Ausgänge sek.	2
Leistung bis	12W
Temperaturschutz	110°C

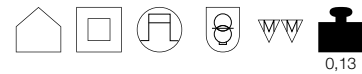
Variante	Art. Nr.
12V	470507
24V	470502

LED NETZTEIL
 12V/24V DC | 20W

Produktangaben

230V ~50Hz
 Material: Kunststoff P
 L: 16,6 cm B: 3,9 cm H: 3,3 cm

Spannung sek.	12V/24V DC
Anzahl Ausgänge sek.	1
Leistung bis	20W
Temperaturschutz	110°C

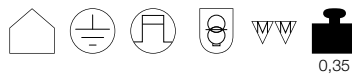
Variante	Art. Nr.
12V	470541
24V	470542

LED NETZTEIL
 24V DC | 36W

Produktangaben

100-240 V ~50/60Hz
 Material: Kunststoff P
 L: 12,9 cm B: 7,5 cm H: 3,2 cm

Spannung sek.	24V DC
Anzahl Ausgänge sek.	1
Leistung bis	36W
Leistungsfaktor	0,9
Temperaturschutz	110°C

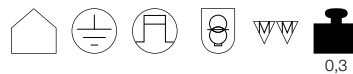
Variante	Art. Nr.
■ schwarz	470544

LED NETZTEIL
 24V DC | 60W

Produktangaben

220-240V ~50/60Hz
 Material: Kunststoff P
 L: 17,5 cm B: 7,8 cm H: 3,5 cm

Spannung sek.	24V DC
Anzahl Ausgänge sek.	2
Leistung bis	60W
Leistungsfaktor	0,95
Temperaturschutz	110°C

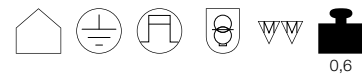
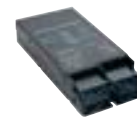
Variante	Art. Nr.
□ weiß	470506

LED NETZTEIL
 24V DC | 100W

Produktangaben

220-240V ~50/60Hz
 Material: Kunststoff P
 L: 18,2 cm B: 8,8 cm H: 3,5 cm

Spannung sek.	24V DC
Anzahl Ausgänge sek.	2
Leistung bis	100W
Leistungsfaktor	0,95
Temperaturschutz	110°C

Variante	Art. Nr.
■ schwarz	470500

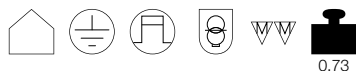
LED NETZTEIL
24V DC | 150W



Produktangaben

220-240V ~50/60Hz
Material: Kunststoff P
L: 20,7 cm B: 11 cm H: 4,5 cm

Spannung sek.	24V DC
Anzahl Ausgänge sek.	1
Leistung bis	150W
Temperaturschutz	110°C

Variante	Art. Nr.
■ schwarz	470549

LED NETZTEIL
24V DC | 150W

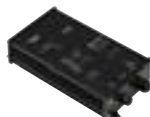

Produktangaben

220-240V ~50/60Hz
Material: Kunststoff P
L: 23,4 cm B: 11,4 cm H: 4,9 cm

Spannung sek.	24V DC
Anzahl Ausgänge sek.	1
Leistung bis	150W
Temperaturschutz	110°C

Variante	Art. Nr.
■ schwarz	470548

LED NETZTEIL
24V DC | 20W

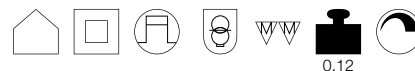

Produktangaben

220-240V ~50/60Hz
Material: Kunststoff P
L: 14,6 cm B: 5,5 cm H: 1,9 cm
Dimmbar: 1-10V

Spannung sek.	24V DC
Anzahl Ausgänge sek.	1
Leistung bis	20W
Temperaturschutz	100°C

Variante	Art. Nr.
□ weiß	470547

LED NETZTEIL
24V DC | 100W

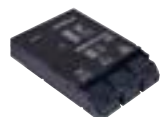

Produktangaben

220-240V ~50/60Hz
Material: Kunststoff P
L: 19 cm B: 13 cm H: 3,5 cm
Dimmbar: 1-10V

Spannung sek.	24V DC
Anzahl Ausgänge sek.	3
Leistung bis	100W
Leistung/Ausgang	33W
Leistungsfaktor	0,95
Temperaturschutz	110°C
Schutz im Fehlerfall	Kurzschluss- & leerlauffest °

Variante	Art. Nr.
■ schwarz	470540

LED NETZTEIL
24V | 50W

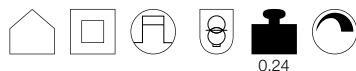

Produktangaben

220-240V ~50/60Hz
Material: Kunststoff P
L: 18,4 cm B: 6,1 cm H: 3,2 cm
Dimmbar: C

Spannung sek.	24V DC
Leistung von	12W
Leistung bis	50W
Temperaturschutz	110°C

Variante	Art. Nr.
■ weiß/blau	1003104

LED NETZTEIL
24V | 100W

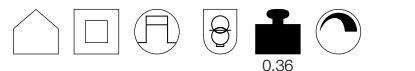

Produktangaben

220-240V ~50/60Hz
Material: Kunststoff P
L: 21 cm B: 6,7 cm H: 3,4 cm
Dimmbar: C

Spannung sek.	24V DC
Leistung von	34W
Leistung bis	100W
Temperaturschutz	110°C

Variante	Art. Nr.
■ weiß/blau	1003105

KOMPENSATIONSMODUL

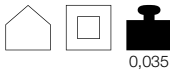

0,035

Produktangaben

220-240V ~50/60Hz
Material: Kunststoff P
L: 9,5 cm Ø: 1,5 cm

Hinweis

Verringert oder beseitigt Probleme beim Dimmen, wie Flimmern, Blinken oder wenn die LED-Beleuchtung nach dem Ausschalten nicht zu 100% erlischt. Der Kompensator wird immer nach dem Dimmer oder Schalter und parallel zum Downlight-Spot oder LED-Treiber angeschlossen.

Variante	Art. Nr.
<input checked="" type="checkbox"/> schwarz	1002785

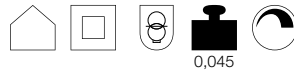
LED TREIBER
350mA | 6W

0,045

Produktangaben

220-240V ~50/60Hz
Material: Kunststoff P
L: 6,3 cm B: 4 cm H: 2,3 cm
Dimmbar: C

Spannung sek.	10-17V DC
Leistung von	3,5W
Leistung bis	5,9W
Leistungsfaktor	0,9
Temperaturschutz	110°C

Variante	Art. Nr.
<input type="checkbox"/> weiß	1002791

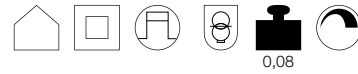
LED TREIBER
350mA | 10W

0,08

Produktangaben

220-240V ~50/60Hz
Material: Kunststoff P
L: 8,5 cm B: 4,1 cm H: 2,2 cm
Dimmbar: C

Spannung sek.	17-29V DC
Ausgangsstrom	350mA
Leistung	10W
Leistung von	5,95W
Leistung bis	10,15W
Leistungsfaktor	0,9
Temperaturschutz	110°C

Variante	Art. Nr.
<input type="checkbox"/> weiß	464140

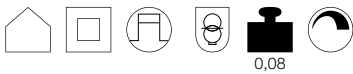
LED TREIBER
350mA | 15W

0,08

Produktangaben

220-240V ~50/60Hz
Material: Kunststoff P
L: 8,5 cm B: 4,1 cm H: 2,2 cm
Dimmbar: C

Spannung sek.	18-30V DC
Ausgangsstrom	350mA
Leistung von	9W
Leistung bis	15W
Leistungsfaktor	0,9
Temperaturschutz	110°C

Variante	Art. Nr.
<input type="checkbox"/> weiß	1002803

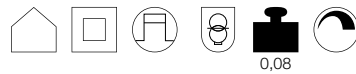
LED TREIBER
500mA | 15W

0,08

Produktangaben

220-240V ~50/60Hz
Material: Kunststoff P
L: 8,5 cm B: 4,1 cm H: 2,2 cm
Dimmbar: C

Spannung sek.	26-43V DC
Ausgangsstrom	500mA
Leistung von	9,1W
Leistung bis	15W
Leistungsfaktor	0,9
Temperaturschutz	110°C

Variante	Art. Nr.
<input type="checkbox"/> weiß	464144

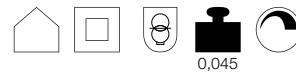
LED TREIBER
700mA | 6W

0,045

Produktangaben

220-240V ~50/60Hz
Material: Kunststoff P
L: 6,3 cm B: 4 cm H: 2,3 cm
Dimmbar: C

Hinweis

Passend für Unterputzdosen Ø 60 mm und einer min. Einbautiefe von 42 mm

Spannung sek.	4,8-8,6V
Ausgangsstrom	700mA
Leistung von	3,4W
Leistung bis	6W
Leistungsfaktor	0,9
Temperaturschutz	110°C

Variante	Art. Nr.
<input type="checkbox"/> weiß	1002792

LED TREIBER

700mA | 10W inkl. Zugentlastung

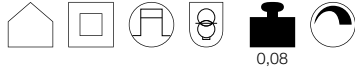

0,08

Produktangaben

220-240V ~50/60Hz
Material: Kunststoff P
L: 8,5 cm B: 4,1 cm H: 2,2 cm
Dimmbar: C

Spannung sek.	40-57V
Ausgangsstrom	700mA
Leistung von	6W
Leistung bis	10,5W
Leistungsfaktor	0,9
Temperaturschutz	110°C

Variante	Art. Nr.
<input type="checkbox"/> weiß	464142

TRIAC LED TREIBER

700mA | 39W inkl. Zugentlastung

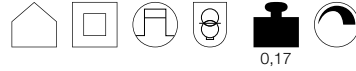

0,17

Produktangaben

220-240V ~50/60Hz
Material: PC
L: 16,6 cm B: 5,2 cm H: 2,4 cm
Dimmbar: C

Spannung sek.	28-56V
Ausgangsstrom	700mA
Leistung von	20W
Leistung bis	39W
Leistungsfaktor	0,95
Temperaturschutz	110°C

Variante	Art. Nr.
<input checked="" type="checkbox"/> weiß/blau	1001267

LED TREIBER

700mA | 40W inkl. Zugentlastung

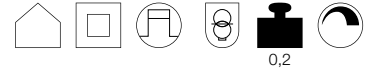

0,2

Produktangaben

220-240V ~50/60Hz
Material: Kunststoff P
L: 15,3 cm B: 6,7 cm H: 3 cm
Dimmbar: C

Spannung sek.	40-57V
Ausgangsstrom	700mA
Leistung von	28W
Leistung bis	39,9W
Leistungsfaktor	0,9
Temperaturschutz	110°C

Variante	Art. Nr.
<input type="checkbox"/> weiß	1001114

LED TREIBER

1000mA

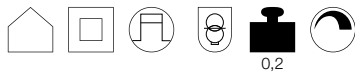

0,2

Produktangaben

220-240V ~50/60Hz
Material: Kunststoff P
L: 15,3 cm B: 6,7 cm H: 3 cm
Dimmbar: C

Spannung sek.	28-40V
Ausgangsstrom	1000mA
Anzahl Ausgänge sek.	1
Leistung	40W
Leistung von	28W
Leistung bis	40W
Leistungsfaktor	0,9
Temperaturschutz	110°C

Variante	Art. Nr.
<input type="checkbox"/> weiß	1001115

LED TREIBER

1050mA | 40W inkl. Zugentlastung

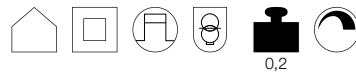

0,2

Produktangaben

220-240V ~50/60Hz
Material: Kunststoff P
L: 16,6 cm B: 5,2 cm H: 2,4 cm
Dimmbar: C

Spannung sek.	19-38
Ausgangsstrom	1050mA
Anzahl Ausgänge sek.	2
Leistung	40W
Leistungsfaktor	0,95
Temperaturschutz	110°C

Variante	Art. Nr.
<input type="checkbox"/> weiß	464804

SLV VALETO®

15W, LED Treiber



IP 20

0,16

Produktangaben

220-240V ~50/60Hz
Leistung: 15W
L: 19 cm B: 6,1 cm H: 3 cm
Material: Kunststoff

Hinweis

Fernsteuerbar und dimmbar mit SLV VALETO® CCT/RGBW Fernbedienung [1002994] oder Gateway [1002411].

Ausgangsstrom	350mA, 500mA, 700mA
Anzahl Ausgänge sek.	1
Leistung	15W
Umgebungstemp. min.	-20°C
Umgebungstemp. max.	40°C
Schutz im Fehlerfall	elektronisch

Variante	Art. Nr.
<input type="checkbox"/> weiß	1002082



1002631 339

1002675 335

DALI – DIE FLEXIBLE BELEUCHTLÖSUNG

Was ist DALI? DALI ist ein System um flexible Lichtszenarien und -inszenierungen frei zu gestalten. Das Bus-fähige System ermöglicht es, Licht und alle Komponenten einer Beleuchtungsanlage einzeln anzusprechen, zu steuern und auszuwerten. So werden Leuchten, Leuchtengruppen und sogar die Beleuchtung ganzer Gebäude gesteuert.

Mit unserem DALI System schaffen Sie eine besondere Atmosphäre in Ihren Verkaufsräumen. Durch die Verwendung von DALI-Strahlern in Verbindung mit unseren speziellen DALI-Adaptoren und Stromschienen gestalten Sie Ihre Beleuchtung flexibel. Dank des vielfältigen Zubehörs kann jede gewünschte Konfiguration realisiert werden: Ob Decken- oder Wandmontage oder als Pendel.

Die Stromschienen bestehen aus einem Aluminium-Strangpressprofil lackiert in Weiß oder Schwarz. Die Schienen sind mit integrierter 2-poliger-DALI-Leitung, in verschiedenen Längen und beliebig ablängbar erhältlich. Ergänzend dazu stehen passende Leuchten mit hohem CRI >90 für dieses System zur Verfügung.

LED TREIBER DALI

250-700mA | 20W

NEW

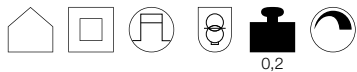

Produktangaben

220-240V ~50/60Hz
Material: PC
L: 15 cm B: 5,2 cm H: 2,8 cm
Dimmbar: 1-10V / Dali

Hinweis

250/350/500/700mA
Ausgangsstrom über DIP Schalter einstellbar

Spannung sek.	6-60V
Leistung von	1,5W
Leistung bis	20W
Temperaturschutz	110°C
Leistungsfaktor	0,9

Variante	Art. Nr.
<input type="checkbox"/> weiß	1002423

LED TREIBER DALI

250-700mA | 40W

NEW

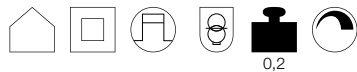

Produktangaben

220-240V ~50/60Hz
Material: PC
L: 12,3 cm B: 7,9 cm H: 2,4 cm
Dimmbar: 1-10V / Dali

Hinweis

250/350/500/700mA
Ausgangsstrom über DIP Schalter einstellbar

Spannung sek.	6-58V
Leistung von	1,5W
Leistung bis	40W
Temperaturschutz	110°C
Leistungsfaktor	0,9

Variante	Art. Nr.
<input type="checkbox"/> weiß	1002424

LED TREIBER DALI

700-1500mA | 50W

NEW

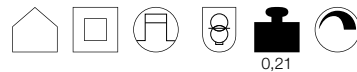

Produktangaben

220-240V ~50/60Hz
Material: PC
L: 12,3 cm B: 7,9 cm H: 2,4 cm
Dimmbar: 1-10V / Dali

Hinweis

700/800/900/1050/1200/1300/1400mA
Ausgangsstrom über DIP Schalter einstellbar

Spannung sek.	6-58V
Leistung von	4,2W
Leistung bis	50W
Temperaturschutz	110°C
Leistungsfaktor	0,9

Variante	Art. Nr.
<input type="checkbox"/> weiß	1002425

LED TREIBER DALI

350-1050mA | 60W

NEW

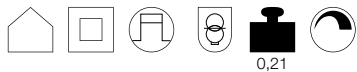

Produktangaben

220-240V ~50/60Hz
Material: PC
L: 12,4 cm B: 7,9 cm H: 2,2 cm
Dimmbar: 1-10V / Dali

Hinweis

350/500/550/650/700/750/
850/900/1000/1050mA
Ausgangsstrom über DIP Schalter einstellbar

Spannung sek.	2-74V
Leistung von	1W
Leistung bis	60W
Temperaturschutz	110°C
Leistungsfaktor	0,95

Variante	Art. Nr.
<input type="checkbox"/> weiß	464032

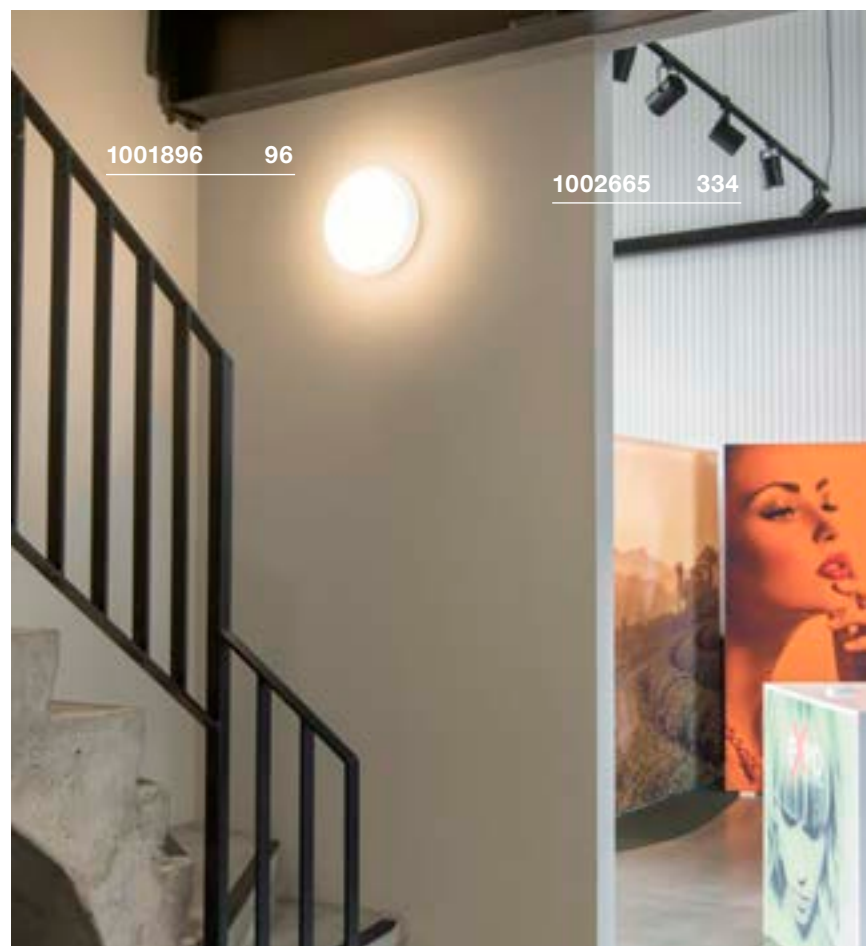

LED TREIBER

320mA | 3W



Produktangaben

100-240V ~50/60Hz
Material: Kunststoff P
L: 5,5 cm B: 3,9 cm H: 2 cm

Spannung sek.	3-9V
Ausgangsstrom	320mA
Leistung von	1W
Leistung bis	3W
Leistungsfaktor	0,4
Temperaturschutz	110°C
Leitungs-L sek. max.	2 m

Variante	Art. Nr.
<input type="checkbox"/> weiß	464108

LED TREIBER

350mA | 3W

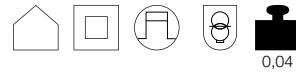

Produktangaben

230V ~50Hz
Material: Kunststoff P
L: 5,6 cm B: 3,9 cm H: 2 cm

Hinweis

inkl. AMP Stecker 350mA

Spannung sek.	3-9V
Ausgangsstrom	350mA
Leistung von	1W
Leistung bis	3W
Leistungsfaktor	0,4
Temperaturschutz	110°C
Leitungs-L sek. max.	2 m

Variante	Art. Nr.
<input type="checkbox"/> weiß	464107

LED TREIBER

350mA | 9W

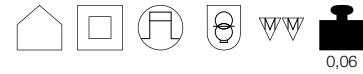

Produktangaben

230V ~50Hz
Material: Kunststoff P
L: 8,5 cm B: 4,1 cm H: 2,2 cm

Spannung sek.	3-26V
Ausgangsstrom	350mA
Leistung von	1W
Leistung bis	9W
Leistungsfaktor	0,4
Temperaturschutz	110°C
Leitungs-L sek. max.	2 m

Variante	Art. Nr.
<input type="checkbox"/> weiß	464109

LED TREIBER

350mA inkl. Zugentlastung

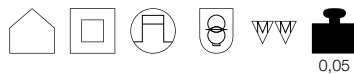

Produktangaben

220-240V ~50/60Hz
Material: Kunststoff P
L: 15,8 cm B: 2,2 cm H: 1,9 cm

Ausgangsstrom	350mA
Anzahl Ausgänge sek.	1
Leistung bis	15W
Leistungsfaktor	0,6
Temperaturschutz	100°C

Variante	Art. Nr.
<input type="checkbox"/> weiß	464031

LED TREIBER

500mA | 9W

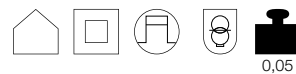

Produktangaben

100-240V ~50/60Hz
Material: Kunststoff P
L: 6,5 cm B: 3,9 cm H: 2 cm

Spannung sek.	12-19V
Ausgangsstrom	500mA
Anzahl Ausgänge sek.	1
Leistung von	6W
Leistung bis	9W
Leistungsfaktor	0,9
Temperaturschutz	110°C
Leitungs-L sek. max.	2 m

Variante	Art. Nr.
<input type="checkbox"/> weiß	464091

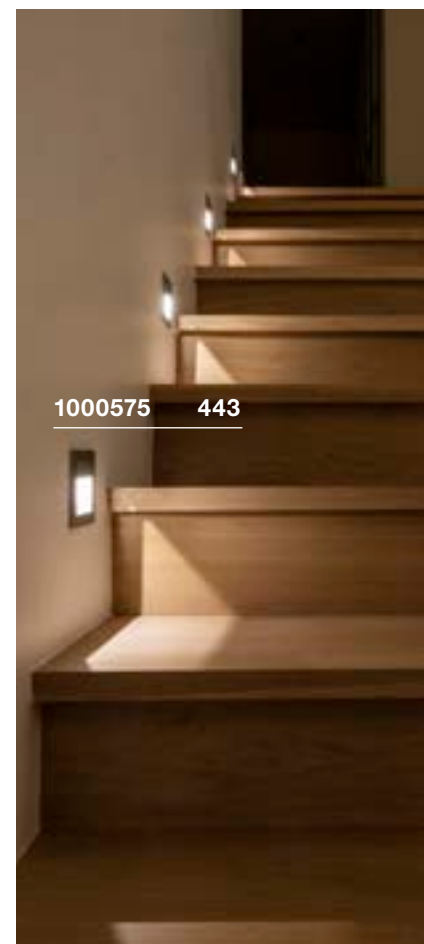

1000575 443

LED TREIBER

700mA | 3W inkl. Zugenlastung



Produktangaben

230V ~50Hz
Material: Kunststoff P
L: 5,5 cm B: 3,9 cm H: 2 cm

Spannung sek.	4-5V
Ausgangsstrom	700mA
Leistung bis	3W
Leistungsfaktor	0,4
Temperaturschutz	110°C
Leitungs-L sek. max.	2 m

Variante	Art. Nr.
<input type="checkbox"/> weiß	464200

LED TREIBER

700mA | 11W inkl. Zugenlastung

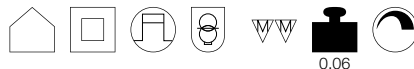

Produktangaben

220-240V ~50/60Hz
Material: Kunststoff P
L: 15,5 cm B: 2,2 cm H: 1,9 cm

Ausgangsstrom	700mA
Leistung bis	11W
Leistungsfaktor	0,6
Temperaturschutz	100°C

Variante	Art. Nr.
<input type="checkbox"/> weiß	464030

LED TREIBER

700mA | 40W inkl. Zugenlastung

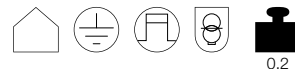

Produktangaben

100-240V ~50/60Hz
Material: Kunststoff P
L: 12,9 cm B: 7,5 cm H: 3,2 cm

Spannung sek.	29-58V
Ausgangsstrom	700mA
Leistung von	20W
Leistung bis	40W
Leistungsfaktor	0,9
Temperaturschutz	110°C
Leitungs-L sek. max.	2 m

Variante	Art. Nr.
<input checked="" type="checkbox"/> schwarz	464168

LED TREIBER VALETO®

1050mA

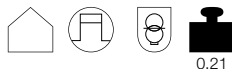

Produktangaben

100-240V ~50/60Hz
Material: Kunststoff
L: 19 cm B: 6,1 cm H: 3 cm

Spannung sek.	30-42V
Ausgangsstrom	1050mA
Anzahl Ausgänge sek.	1
Leistung	42W
Leistung von	31,5W
Leistung bis	45W
Leistungsfaktor	0,95
Temperaturschutz	110°C
Leitungs-L sek. max.	2 m

Variante	Art. Nr.
<input type="checkbox"/> weiß	1001249

LED TREIBER

1000mA | 40W inkl. Zugenlastung



Produktangaben

100-240V ~50/60Hz
Material: Kunststoff P
L: 12,9 cm B: 7,5 cm H: 3,2 cm

Spannung sek.	20-40V
Ausgangsstrom	1000mA
Anzahl Ausgänge sek.	1
Leistung von	20W
Leistung bis	40W
Leistungsfaktor	0,9
Temperaturschutz	110°C
Leitungs-L sek. max.	2 m

Variante	Art. Nr.
<input checked="" type="checkbox"/> schwarz	464170

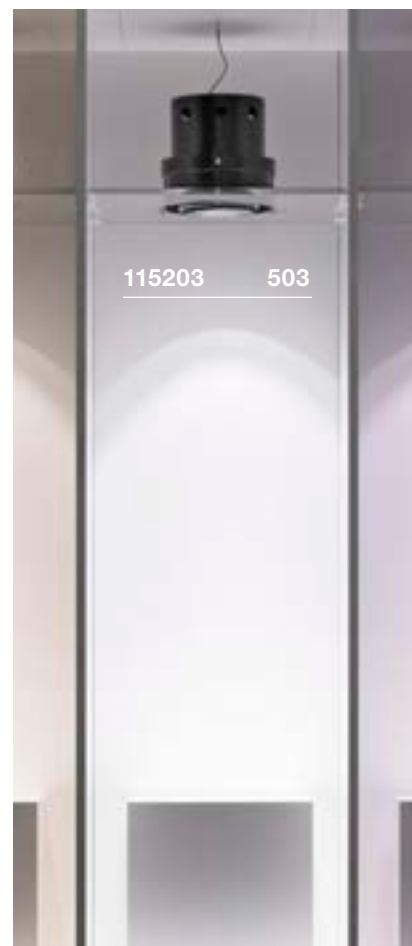

DECKENHAKEN



0,04

Produktangaben

Material: Aluminium
 Ø: 1,8 cm L: 4,6 cm

DECKENHAKEN



0,04

Produktangaben

Material: Aluminium
 Ø: 1,8 cm L: 4,6 cm

Variante	Art. Nr.
<input checked="" type="checkbox"/> schwarz	132670

Variante	Art. Nr.
<input type="checkbox"/> weiß	132671

KABELKLEMME



0,01

Produktangaben

Material: Aluminium
 Ø: 1,4 cm L: 3,1 cm

KABELKLEMME



0,01

Produktangaben

Material: Aluminium
 Ø: 1,4 cm L: 3,1 cm

Variante	Art. Nr.
<input checked="" type="checkbox"/> schwarz	132680

Variante	Art. Nr.
<input type="checkbox"/> weiß	132681

132670

858



132680

858



DECKENROSETTE

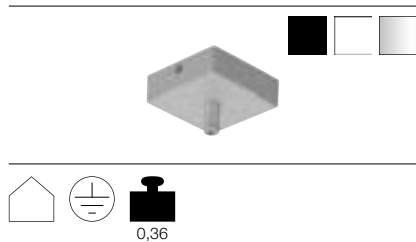

Produktangaben

230V ~50Hz
 Material: Aluminium
 L: 8,5 cm B: 8,5 cm H: 2,7 cm

TEXTILKABEL
 3-polig, 3 x 0,75 mm², 5 m



Produktangaben

Spannung max. 300V
 Umgebungstemp. max. 70°C
 Material: PVC
 Ø: 0,6 cm L: 500 cm

TEXTILKABEL
 3-polig, 3 x 0,75 mm², 10m

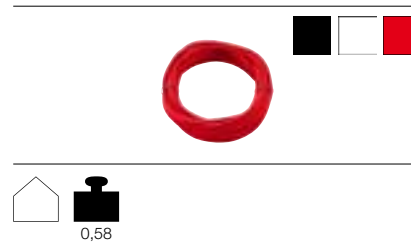

Produktangaben

Spannung max. 300V
 Material: PVC
 Ø: 0,6 cm L: 1000 cm

Strombelastung max. 8,5mA

Variante	Art. Nr.
■ schwarz matt	210060
□ weiß matt	210061
■ silber	210064

Variante	Art. Nr.
■ schwarz	961370
□ weiß	961371
■ rot	961376

Variante	Art. Nr.
■ schwarz	961270
□ weiß	961271
■ rot	961276

KABEL

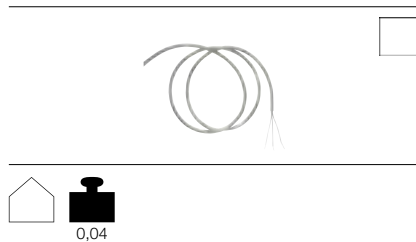

Produktangaben

Spannung max. 300V
 L: 1000 cm

DRAHTSEILABHÄNGUNG

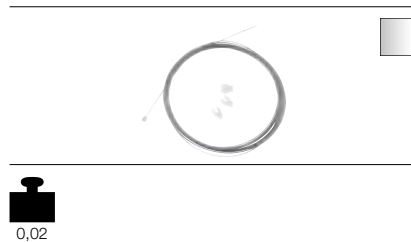

Produktangaben

Material: Stahl/Kunststoff
 Ø: 0,15 cm L: 500 cm

STOPPER FÜR DRAHTSEIL

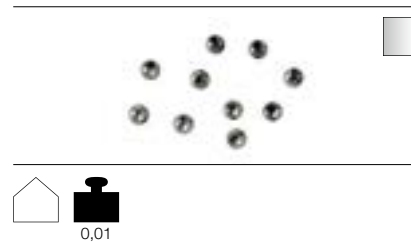

Produktangaben

Material: Stahl
 Ø: 0,8 cm

mech. Belastung max. 40 kg

Variante	Art. Nr.
□ transparent	961250

Variante	Art. Nr.
■ silber	961037

Variante	Art. Nr.
■ silber	961034

STECKERLEISTE 3 Ausgänge



0,02

Produktangaben

Material: Kunststoff
L: 5,2 cm B: 1,4 cm H: 1,3 cm

Hinweis

Für 350mA Stecksystem

STECKERLEISTE 6 Ausgänge



0,04

Produktangaben

Material: Kunststoff
L: 5,2 cm B: 3 cm H: 1,3 cm

Hinweis

Für 350mA Stecksystem

GU10 FASSUNG mit Anschlussbox und Schnellklemme



0,065

Produktangaben

L: 27 cm

Variante	Art. Nr.
■ schwarz	111850

Variante	Art. Nr.
■ schwarz	111860

Variante	Art. Nr.
■ weiß/schwarz	1000909

KABELVERLÄNGERUNG



0,02

Produktangaben

Material: Kunststoff
L: 100 cm

Hinweis

Mit AMP Stecker und Kupplung
Für 350mA Stecksystem

KABELVERLÄNGERUNG

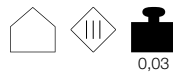

0,03

Produktangaben

Material: Kunststoff
L: 200 cm

Hinweis

Mit AMP Stecker und Kupplung
Für 350mA Stecksystem

GU10 FASSUNG



0,02

Produktangaben

230V ~50Hz
Material: Keramik
L: 300 cm B: 0,9 cm

Variante	Art. Nr.
■ schwarz	111861

Variante	Art. Nr.
■ schwarz	111862

Variante	Art. Nr.
□ weiß	955135

ROHRKIT NEPRO DISPLAY



Produktangaben

Material: Kunststoff

Hinweis

Rohrkit, 2-teilig, Kunststoff. ur Befestigung an Rohren und Traversen mit einem Durchmesser von 32-42 mm.

Variante	Art. Nr.
■ schwarz	146479

STECKERLEISTE
3 Ausgänge

Produktangaben

Material: Kunststoff
L: 5,5 cm B: 1,4 cm H: 1,2 cm

Hinweis

Für 700mA Stecksystem

Variante	Art. Nr.
■ schwarz	111830

STECKERLEISTE
6 Ausgänge

Produktangaben

Material: Kunststoff
L: 5,1 cm B: 2,9 cm H: 1,2 cm

Hinweis

Für 700mA Stecksystem

Variante	Art. Nr.
■ schwarz	111831

DOPPELSEITIGES
KLEBEBAND

Produktangaben

L: 300 cm B: 0,9 cm

Variante	Art. Nr.
□ klar	220000

KABELVERLÄNGERUNG



Produktangaben

Material: Kunststoff
L: 100 cm

Hinweis

Mit AMP Stecker und Kupplung
Für 700mA Stecksystem

Variante	Art. Nr.
■ schwarz	111832

KABELVERLÄNGERUNG



Produktangaben

Material: Kunststoff
L: 200 cm

Hinweis

Mit AMP Stecker und Kupplung
Für 700mA Stecksystem

Variante	Art. Nr.
■ schwarz	111833

4-FACH GARTENSTECKDOSE



0,9 IP 44

Produktangaben

230V ~50Hz
 Material: Kunststoff
 L: 10,5 cm B: 13 cm H: 21 cm
 Netzkabellänge: 1,5 m

Hinweis

Für die Anwendung in Deutschland.

Strombelastung max. 16mA

Variante	Art. Nr.
■ schwarz	1000868

4-FACH GARTENSTECKDOSE



0,92 IP 44

Produktangaben

230V ~50Hz
 Material: Kunststoff
 L: 10,5 cm B: 13 cm H: 21 cm
 Netzkabellänge: 1,5 m

Hinweis

Für die Anwendung in Frankreich.

Strombelastung max. 16mA

Variante	Art. Nr.
■ schwarz	1000869

4-FACH GARTENSTECKDOSE

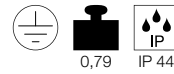

0,79 IP 44

Produktangaben

230V ~50Hz
 Material: Kunststoff
 L: 10,5 cm B: 13 cm H: 21 cm
 Netzkabellänge: 1,5 m

Hinweis

Für die Anwendung in der Schweiz.

Strombelastung max. 10mA

Variante	Art. Nr.
■ schwarz	1000870

4-FACH GARTENSTECKDOSE



0,93 IP 44

Produktangaben

230V ~50Hz
 Material: Kunststoff
 L: 14,5 cm B: 13 cm H: 21 cm
 Netzkabellänge: 1,5 m

Hinweis

Für die Anwendung in Großbritannien.

Strombelastung max. 13mA

Variante	Art. Nr.
■ schwarz	1000871

4-FACH GARTENSTECKDOSE



0,9 IP 44

Produktangaben

230V ~50Hz
 Material: Kunststoff
 L: 10,5 cm B: 13 cm H: 21 cm
 Netzkabellänge: 1,5 m

Hinweis

Für die Anwendung in Dänemark.

Strombelastung max. 10mA

Variante	Art. Nr.
■ schwarz	1000872

4-FACH GARTENSTECKDOSE

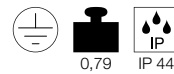

0,79 IP 44

Produktangaben

230V ~50Hz
 Material: Kunststoff
 L: 10,8 cm B: 12,7 cm H: 21 cm
 Netzkabellänge: 1,5 m

Hinweis

Für die Anwendung in Italien.

Strombelastung max. 10mA

Variante	Art. Nr.
■ schwarz	1000873

4-FACH GARTENSTECKDOSE



2,09 IP 44

Produktangaben

230V ~50Hz
 Material: Kunststoff
 L: 10,5 cm B: 13 cm H: 21 cm
 Netzkabellänge: 10 m

Hinweis

Für die Anwendung in Deutschland.

Strombelastung max. 16mA

Variante	Art. Nr.
■ schwarz	1000874

4-FACH GARTENSTECKDOSE



2,21 IP 44

Produktangaben

230V ~50Hz
 Material: Kunststoff
 L: 10,5 cm B: 13 cm H: 21 cm
 Netzkabellänge: 10 m

Hinweis

Für die Anwendung in Frankreich.

Strombelastung max. 16mA

Variante	Art. Nr.
■ schwarz	1000875

4-FACH GARTENSTECKDOSE



1,98 IP 44

Produktangaben

230V ~50Hz
 Material: Kunststoff
 L: 10,5 cm B: 13 cm H: 21 cm
 Netzkabellänge: 10 m

Hinweis

Für die Anwendung in der Schweiz.

Strombelastung max. 10mA

Variante	Art. Nr.
■ schwarz	1000876

4-FACH GARTENSTECKDOSE



2,12 IP 44

Produktangaben

230V ~50Hz
 Material: Kunststoff
 L: 14,5 cm B: 13 cm H: 21 cm
 Netzkabellänge: 10 m

Hinweis

Für die Anwendung in Großbritannien.

Strombelastung max. 13mA

Variante	Art. Nr.
■ schwarz	1000877

4-FACH GARTENSTECKDOSE



2,09 IP 44

Produktangaben

230V ~50Hz
 Material: Kunststoff
 L: 10,5 cm B: 13 cm H: 21 cm
 Netzkabellänge: 10 m

Hinweis

Für die Anwendung in Dänemark.

Strombelastung max. 10mA

Variante	Art. Nr.
■ schwarz	1000878

4-FACH GARTENSTECKDOSE



1,98 IP 44

Produktangaben

230V ~50Hz
 Material: Kunststoff
 L: 10,8 cm B: 12,7 cm H: 21 cm
 Netzkabellänge: 10 m

Hinweis

Für die Anwendung in Italien.

Strombelastung max. 10mA

Variante	Art. Nr.
■ schwarz	1000879

ENERGIE-PACK
230V

4,21 IP 54

Produktangaben

230V ~50Hz
Material: Stahl/Kunststoff
L: 35 cm B: 12 cm H: 12 cm

Hinweis

Nicht für den Außenbereich geeignete Treiber können im Energie-Pack untergebracht werden.
3 Ausgänge für metrische Kabelverschraubung nach EN 50262 M12.
1 Eingang für metrische Kabelverschraubung nach EN 50262 M25.

Strombelastung max. 16mA

Variante	Art. Nr.
■ grau	227000

VERBINDUNGSBOX



0,02 IP 68

Produktangaben

230V ~50Hz
Material: PA66 GF
Ø: 2,7 cm L: 11,5 cm

Hinweis

3-polig

Spannung max. 450V
Strombelastung max. 17,5mA

Variante	Art. Nr.
■ schwarz	228730

VERBINDUNGSBOX

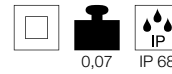

0,07 IP 68

Produktangaben

230V ~50Hz
Material: PA66 GF
Ø: 3,2 cm L: 13 cm

Hinweis

5-polig

Spannung max. 450V
Strombelastung max. 32mA

Variante	Art. Nr.
■ schwarz	228725

VERBINDUNGSBOX
4-fach

0,21 IP 68

Produktangaben

230V ~50Hz
Material: PP
Ø: 7,2 cm L: 16 cm

Hinweis

Max. Kabeldurchmesser 5-14 mm

Spannung max. 1000V

Variante	Art. Nr.
■ gelb/schwarz	229269

T-VERBINDERBOX



0,11 IP 68

Produktangaben

230V ~50Hz
Material: PA 66
L: 11 cm B: 6,4 cm H: 3 cm

Spannung max. 500V
Strombelastung max. 17,5mA

Variante	Art. Nr.
■ schwarz	228726

T-VERBINDERBOX



0,25 IP 55

Produktangaben

230V ~50Hz
Material: PA 66
Ø: 15,5 cm H: 4,6 cm

Spannung max. 500V

Variante	Art. Nr.
■ schwarz	229260

T-VERBINDERBOX



Produktangaben

230V ~50Hz
Material: PA 66
L: 25 cm B: 4,5 cm H: 6 cm

Spannung max. 500V

Variante	Art. Nr.
■ schwarz	229262



1000868 862

SLV KABEL
H05RN-F

Produktangaben

300V/500V
Material: Kupfer/Gummi
Ø: 7,2 cm L: 2000 cm
3-adrig

Variante	Art. Nr.
■ schwarz	1000700

SLV KABEL
H07RN-F

Produktangaben

450V/750V
Material: Kupfer/Gummi
Ø: 9,1 cm L: 2000 cm
3-adrig

Variante	Art. Nr.
■ schwarz	1000701

BEWEGUNGSMELDER
Infrarot

Produktangaben

220-240V ~50Hz
Material: Kunststoff
B: 6,5 cm H: 9,5 cm T: 10 cm

Hinweis

Erfassungswinkel 180°. Reichweite max. 12 m.
Einschaltdauer von ca. 10 Sekunden
bis ca. 4 Minuten regelbar.

Variante	Art. Nr.
□ weiß	410861
■ anthrazit	410865

DIE QUELLE ALLEN LICHTS.

FÜR JEDE LICHTLÖSUNG DAS RICHTIGE LEUCHTMITTEL.

Die richtige Lichtwirkung ist das Ergebnis eines perfekten Zusammenspiels von Leuchte und Leuchtmittel. Neben der Bauform ist auch die Energieeffizienz ein wichtiges Kriterium. In den letzten Jahren hat eine Vielzahl von Alternativen zur klassischen Glühlampe in den Markt Einzug gehalten. So findet sich für jeden Anwendungs- und Leuchtentyp das passende Leuchtmittel.

LEUCHTMITTEL

ALLGEMEINE INFORMATIONEN.

- Die angegebenen Energieeffizienzklassen entsprechen der europäischen Verordnung Nr. 874/2012. Die Energieetiketten zu den einzelnen Artikeln stellen wir unter slv.com zum Download bereit.
- Der Betrieb bei offenen Leuchten ohne Schutzglas ist nur mit Niederdrucklampen zulässig. Leuchtmittel mit diesem Zeichen (Norm IEC 357) sind für den Einsatz in Leuchten ohne Schutzglas geeignet.
- Halogenleuchtmittel und Metalldampfentladungslampen (HID) können zur Aufheizung des jeweiligen Leuchtengehäuses führen. Letzteres darf daher nur im abgekühlten Zustand berührt werden. Verstellbare Leuchten bzw. Leuchtenköpfe, die nicht über Verstellgriff verfügen oder die bei Betrieb mit der maximalen Leuchtmittelleistung die maximal zulässige Gehäusestemperatur an der offensichtlichen Berührungsstelle übersteigen, sind zudem außerhalb des Handbereichs zu montieren. Als Niedrigtemperatur-Alternative sind zu den meisten unserer Halogenleuchten LED-Retrofit-Leuchtmittel erhältlich. Entsprechende Lösungen finden Sie in diesem Kapitel.
- Auch Niedervolt-Leuchten können in vielen Fällen mit passenden LED-Retrofit-Leuchtmitteln betrieben werden. Aufgrund der im Einzelfall aufeinandertreffenden, jeweils spezifische Trafo- und LED-Technik ist jedoch nicht jede Kombination von Leuchten mit augenscheinlich passenden Leuchtmitteln möglich. Bei Fragen zur Kompatibilität finden Sie Informationen unter slv.com oder wenden Sie sich an unsere Verkaufsabteilung.
- Die Maßangaben der Leuchtmittel beziehen sich immer auf die kompletten Außenmaße eines Leuchtmittels. Das bedeutet inklusive Gewindefassung.
- **Alle Lampen sind gesondert zu entsorgen und gehören nicht in den Hausmüll.**



LED QT14
G9A+  Spektrum
A++-E

Produktangaben

220-240V ~50/60Hz
Leistung: 2,5W
Ø: 1,6 cm L: 4,8 cm

Lampenstrom	0,012A
Leistung	2,5W
Energieverbrauch/1000h	3kWh
Farbtemperatur	3000K
Lichtstrom	180lm
Farbwiedergabeindex	>80

Variante	Art. Nr.
	560302

LED FILAMENT
G9A+  Spektrum
A++-E

NEW

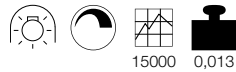

Produktangaben

220-240V ~50/60Hz
Leistung: 2,7W
Ø: 1,4 cm L: 6,8 cm
Dimmbar: C

Lampenstrom	0,0135A
Leistung	2,7W
Energieverbrauch/1000h	3kWh
Farbtemperatur	2600K
Lichtstrom	250lm
Farbwiedergabeindex	>90

Variante	Art. Nr.
	1003102 

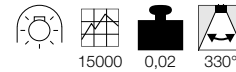
LED QT-DE12
R7S 78mmA+  Spektrum
A++-E

Produktangaben

220-240V ~50/60Hz
Leistung: 5,5W
Ø: 2,5 cm L: 7,8 cm

Lampenstrom	0,044A
Leistung	5,5W
Energieverbrauch/1000h	6kWh
Farbtemperatur	3000K
Lichtstrom	530lm
Farbwiedergabeindex	>80

Variante	Art. Nr.
	560332

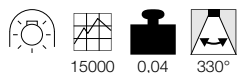
LED QT-DE12
R7S 118mmA+  Spektrum
A++-E

Produktangaben

220-240V ~50/60Hz
Leistung: 10,5W
Ø: 2,5 cm L: 11,8 cm

Lampenstrom	0,081A
Leistung	10,5W
Energieverbrauch/1000h	11kWh
Farbtemperatur	2700K
Lichtstrom	1050lm
Farbwiedergabeindex	>80

Variante	Art. Nr.
	560352

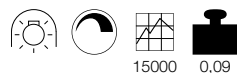
LED QT-DE12
R7S 118mmA++  Spektrum
A++-E

Produktangaben

220-240V ~50/60Hz
Leistung: 14W
Ø: 2,9 cm L: 11,8 cm
Dimmbar: L, C

Lampenstrom	0,075A
Leistung	14W
Energieverbrauch/1000h	14kWh
Farbtemperatur	3000K
Lichtstrom	2000lm
Farbwiedergabeindex	>80

Variante	Art. Nr.
	1002135

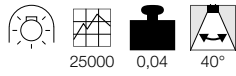
LED QR51
GU5.3A+ Spektrum
A++-E

25000 0,04 40°

Produktangaben

12V ~50Hz
Leistung: 3,8W
Ø: 5 cm H: 4,7 cm

Hinweis

Betrieb nur mit konventionellem Trafo.

Lampenstrom	0,52A
Leistung	3,8W
Energieverbrauch/1000h	5kWh
Lichtstrom	225lm
max. Lichtstärke	500cd
Farbwiedergabeindex	>80

Variante	Art. Nr.
2700K	551242
3000K	551243

LED QR51
GU5.3A+ Spektrum
A++-E

25000 0,05 36°

Produktangaben

12V AC
Leistung: 5,5W
Ø: 5 cm H: 4,5 cm

Hinweis

Betrieb nur mit konventionellem Trafo.

Lampenstrom	0,63A
Leistung	5,5W
Energieverbrauch/1000h	7kWh
max. Lichtstärke	1000cd
Farbwiedergabeindex	>80

Variante	Art. Nr.
2700K 450lm	1001574
3000K 460lm	1001575

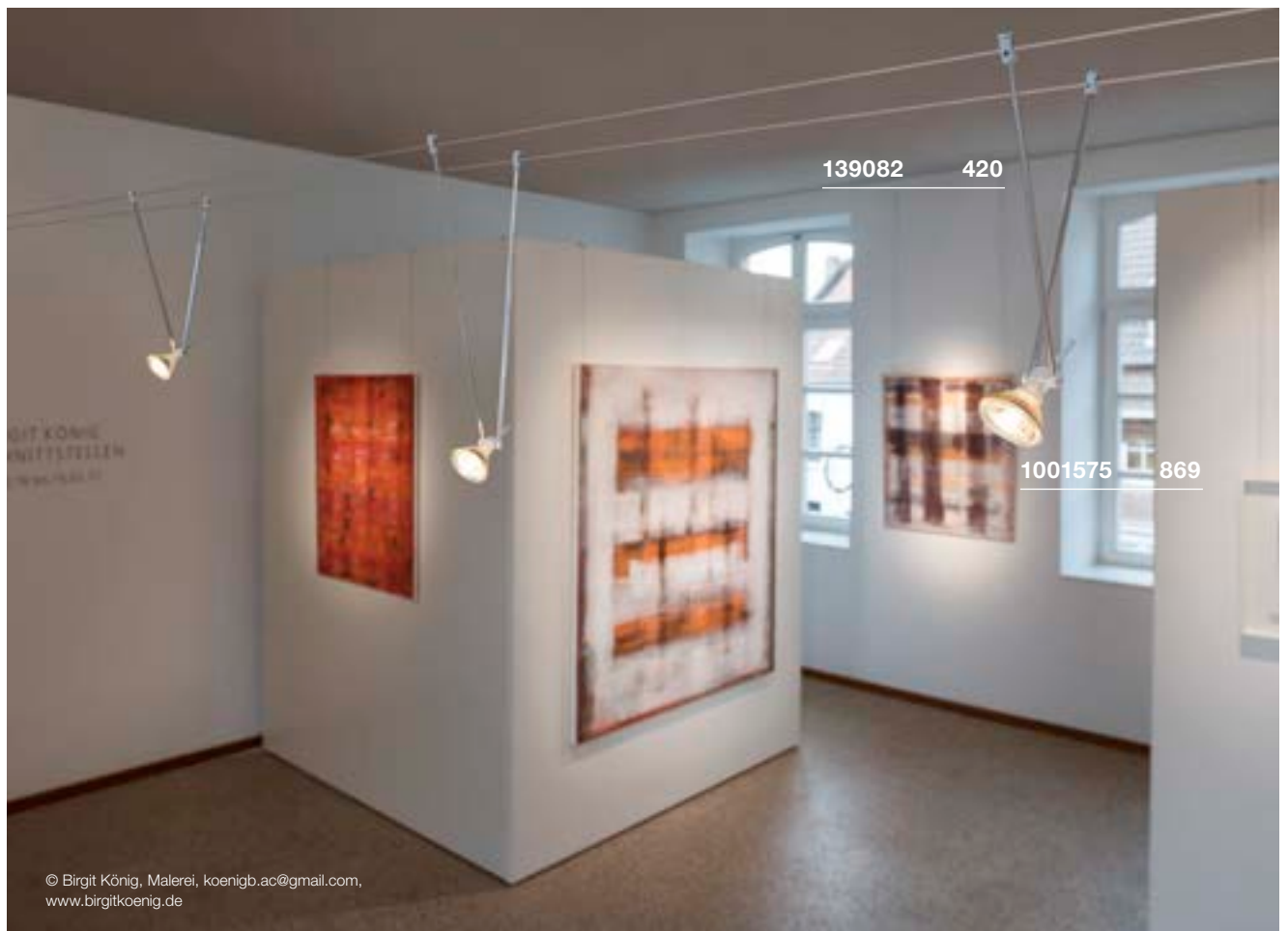

139082 420

1001575 869

LED T32 FILAMENT
GU10A+ Spektrum
A++-E

NEW



20000 0,06 38°

Produktangaben

220-240V ~50/60Hz
Leistung: 4W
Ø: 3,2 cm L: 10 cm
Dimmbar: C

Lampenstrom	0,02A
Leistung	4W
Energieverbrauch/1000h	4kWh
Farbtemperatur	2600K
Lichtstrom	260lm
max. Lichtstärke	700cd
Farbwiedergabeindex	>90

Variante	Art. Nr.
	1003101

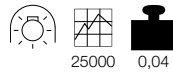
LED QPAR51
GU10, SLV VALETO®A+ Spektrum
A++-E

25000 0,04

Produktangaben

220-240V ~50/60Hz
Ø: 5 cm L: 5,4 cm

Hinweis

Fernsteuerbar und dimmbar mit SLV VALETO®
CCT/RGBW Fernbedienung [1002994] oder
Gateway [1002411]

Energieverbrauch/1000h	6kWh
Lichtstrom	350lm
Farbwiedergabeindex	>80

Variante	Art. Nr.
Tunable white 2700-6500K	
5,1W 48°	1001918
RGBW 5,6W 60°	1001919

LED QPAR51
GU10A+ Spektrum
A++-E

25000 0,04 36°

Produktangaben

220-240V ~50/60Hz
Leistung: 3,7W
Ø: 5 cm H: 5,4 cm
Dimmbar: L, C

Hinweis

Besonders für Außenleuchten geeignet.

Lampenstrom	0,02A
Leistung	3,7W
Energieverbrauch/1000h	4kWh
Farbtemperatur	2700K
Lichtstrom	260lm
max. Lichtstärke	500cd
Farbwiedergabeindex	>90

Variante	Art. Nr.
	560122

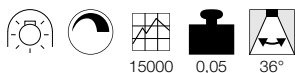
LED QPAR51
GU10A+ Spektrum
A++-E

15000 0,05 36°

Produktangaben

220-240V ~50/60Hz
Leistung: 7,2W
Ø: 5 cm H: 5,7 cm
Dimmbar: L, C

Lampenstrom	0,036A
Leistung	7,2W
Energieverbrauch/1000h	8kWh
Farbtemperatur	2700K
Lichtstrom	520lm
max. Lichtstärke	1000cd
Farbwiedergabeindex	>80

Variante	Art. Nr.
silber	560542
weiß	560552
schwarz	1001560

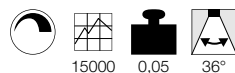
LED QPAR51
GU10A+ Spektrum
A++-E

15000 0,05 36°

Produktangaben

220-240V ~50/60Hz
Leistung: 7,2W
Ø: 5 cm H: 5,4 cm
Dimmbar: L, C

Lampenstrom	0,036A
Leistung	7,2W
Energieverbrauch/1000h	8kWh
Farbtemperatur	3000K
Lichtstrom	520lm
max. Lichtstärke	1000cd
Farbwiedergabeindex	>80

Variante	Art. Nr.
silber	1001561
weiß	1001562
schwarz	1001563

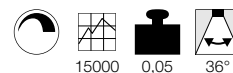
LED QPAR51
GU10A+ Spektrum
A++-E

15000 0,05 36°

Produktangaben

220-240V ~50/60Hz
Leistung: 7,2W
Ø: 5 cm H: 5,4 cm
Dimmbar: L, C

Lampenstrom	0,036A
Leistung	7,2W
Energieverbrauch/1000h	8kWh
Farbtemperatur	4000K
Lichtstrom	540lm
max. Lichtstärke	1035cd
Farbwiedergabeindex	>80

Variante	Art. Nr.
silber	1001564
weiß	1001565
schwarz	1001566



LED QPAR51
GU10

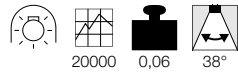

Produktangaben

220-240V ~50/60Hz
Leistung: 5,5W
Ø: 5 cm H: 5,5 cm
Dimmbar: Switch

Lampenstrom	0,038A
Leistung	5,5W
Energieverbrauch/1000h	6kWh
Farbtemperatur	2700K
Lichtstrom	400lm
max. Lichtstärke	700cd
Farbwiedergabeindex	>80

Variante	Art. Nr.
	1001030

LED QPAR51
GU10

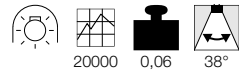

Produktangaben

220-240V ~50/60Hz
Leistung: 5,5W
Ø: 5 cm H: 5,2 cm
Dimmbar: Switch

Lampenstrom	0,038A
Leistung	5,5W
Energieverbrauch/1000h	6kWh
Farbtemperatur	3000K
Lichtstrom	440lm
max. Lichtstärke	770cd
Farbwiedergabeindex	>80

Variante	Art. Nr.
	551902

LED QPAR51
GU10

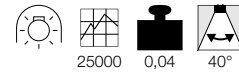
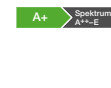

Produktangaben

220-240V ~50/60Hz
Leistung: 4,3W
Ø: 5 cm H: 5,4 cm

Lampenstrom	0,039A
Leistung	4,3W
Energieverbrauch/1000h	5kWh
Lichtstrom	245lm
max. Lichtstärke	530cd
Farbwiedergabeindex	>80

Variante	Art. Nr.
2700K	551252
3000K	551253



LED QPAR111
GU10A+ Spektrum
A++-E

NEW

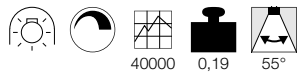

40000 0,19 55°

Produktangaben

220-240V ~50/60Hz
Leistung: 13W
Ø: 11 cm L: 7 cm
Dimmbar: C

Lampenstrom	0,052A
Leistung	13W
Energieverbrauch/1000h	13kWh
Farbwiedergabeindex	>90

Variante	Art. Nr.
2700K 840lm	1003094
4000K 950lm	1003095

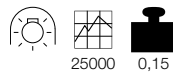
LED QPAR111
GU10, CCT, SLV VALETO®A+ Spektrum
A++-E

25000 0,15

Produktangaben

220-240V ~50/60Hz
Leistung: 9W
Ø: 11,1 cm H: 7 cm

Hinweis

Fernsteuerbar und dimmbar mit SLV VALETO®
CCT/RGBW Fernbedienung [1002994] oder
Gateway [1002411]

Lampenstrom	0,048A
Leistung	9W
Energieverbrauch/1000h	9kWh
Farbtemperatur	2700K-6500K
Lichtstrom	800lm
Farbwiedergabeindex	>80

Variante	Art. Nr.
3300cd 25°	1001920
1900cd 40°	1001921

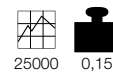
LED QPAR111
GU10, RGBW, SLV VALETO®A+ Spektrum
A++-E

25000 0,15

Produktangaben

220-240V ~50/60Hz
Leistung: 9W
Ø: 11,1 cm H: 7 cm

Hinweis

Fernsteuerbar und dimmbar mit SLV VALETO®
CCT/RGBW Fernbedienung [1002994] oder
Gateway [1002411]

Lampenstrom	0,048A
Leistung	9W
Energieverbrauch/1000h	9kWh
Farbtemperatur	RGBW
Lichtstrom	800lm
max. Lichtstärke	3700cd
Farbwiedergabeindex	>80

Variante	Art. Nr.
25°	1001922
40°	1001923

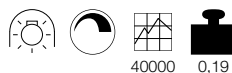
LED QPAR111
GU10A+ Spektrum
A++-E

40000 0,19

Produktangaben

230V ~50Hz
Leistung: 13W
Ø: 11,1 cm H: 7,1 cm
Dimmbar: C

Lampenstrom	0,052A
Leistung	13W
Energieverbrauch/1000h	13kWh
Farbtemperatur	2700K
Farbwiedergabeindex	>80

Variante	Art. Nr.
1100lm 1670cd 30°	1001242
1000lm 140°	1001244

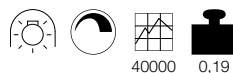
LED QPAR111
GU10A+ Spektrum
A++-E

40000 0,19

Produktangaben

230V ~50Hz
Leistung: 13W
Ø: 11,1 cm H: 7,1 cm
Dimmbar: C

Lampenstrom	0,052A
Leistung	13W
Farbtemperatur	4000K
Farbwiedergabeindex	>80

Variante	Art. Nr.
13kWh 1300lm 1950cd 30°	1001243
30kWh 1100lm 140°	1001245

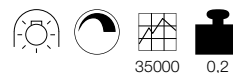
LED QPAR111
GU10A+ Spektrum
A++-E

35000 0,2

Produktangaben

220-240V ~50/60Hz
Leistung: 13W
Ø: 11 cm H: 7,1 cm
Dimmbar: C

Lampenstrom	0,052A
Leistung	13W
Energieverbrauch/1000h	13kWh
Farbtemperatur	4000K
Farbwiedergabeindex	>90

Variante	Art. Nr.
1100lm 30°	1003087
1000lm 140°	1003088



LED QPAR111 GU10

A+ Spektrum A++-E

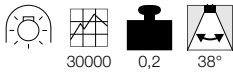

Produktangaben

220-240V ~50/60Hz
Leistung: 6,5W
Ø: 11 cm H: 7 cm

Lampenstrom	0,046A
Leistung	6,5W
Energieverbrauch/1000h	7kWh
Farbtemperatur	2700K
Lichtstrom	390lm
max. Lichtstärke	785cd
Farbwiedergabeindex	>80

Variante	Art. Nr.
	551882

LED QPAR111 GU10

A+ Spektrum A++-E



Produktangaben

220-240V ~50/60Hz
Leistung: 6,5W
Ø: 11,1 cm H: 7 cm
Dimmbar: Switch

Hinweis

3 Stufen dimmbar mit normalem Wandschalter. Durch das Aus- und wieder Einschalten, dimmt sich das Leuchtmittel stufenweise.

Lampenstrom	0,048A
Leistung	6,5W
Energieverbrauch/1000h	7kWh
Farbwiedergabeindex	>80

Variante	Art. Nr.
2700K 400lm 720cd	1000684
3000K 420lm 750cd	551912

LED QPAR111 GU10

A+ Spektrum A++-E



Produktangaben

220-240V ~50/60Hz
Leistung: 10W
Ø: 11,1 cm H: 7 cm
Dimmbar: Switch

Hinweis

3 Stufen dimmbar mit normalem Wandschalter. Durch das Aus- und wieder Einschalten, dimmt sich das Leuchtmittel stufenweise.

Lampenstrom	0,82A
Leistung	10W
Energieverbrauch/1000h	10kWh
Farbwiedergabeindex	>80

Variante	Art. Nr.
2700K 540lm 890cd	1001028
3000K 630lm 1040cd	1001029

LED QPAR111 GU10

A+ Spektrum A++-E

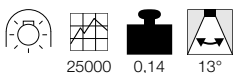

Produktangaben

220-240V ~50/60Hz
Ø: 11,1 cm H: 7,3 cm

Energieverbrauch/1000h	8kWh
Lichtstrom	730lm
max. Lichtstärke	5600cd
Farbwiedergabeindex	>80

Variante	Art. Nr.
2700K 7,3W 0,069A	1000939
3000K 7W 0,04A	1001568
4000K 7,3W 0,069A	1000940

LED QPAR111 GU10

A+ Spektrum A++-E

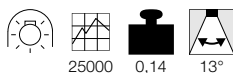

Produktangaben

220-240V ~50/60Hz
Ø: 11,1 cm H: 7,3 cm

Lampenstrom	0,04A
Leistung	7W
Energieverbrauch/1000h	8kWh
Lichtstrom	730lm
max. Lichtstärke	5600cd
Farbwiedergabeindex	>80

Variante	Art. Nr.
2700K 7,3W 0,069A	1000941
3000K 7W 0,04A	1001569
4000K 7,3W 0,069A	1000942

LED QPAR111 GU10

A+ Spektrum A++-E

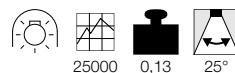

Produktangaben

220-240V ~50/60Hz
Leistung: 7,9W
Ø: 11,1 cm

Energieverbrauch/1000h	8kWh
Farbwiedergabeindex	>80

Variante	Art. Nr.
2700K 730lm 7,9W 0,039A 1900cd	
H: 7cm	560702
3000K 730lm 7W 0,04A 1800cd	
H: 7,3 cm	1001570
4000K 760lm 7,9W 0,04A 1800cd	
H: 7cm	560704

LED QPAR111
GU10

A+ Spektrum A++-E

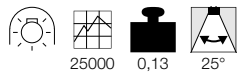

Produktangaben

220-240V ~50/60Hz
Ø: 11,1 cm H: 7 cm

Energieverbrauch/1000h 8kWh
Farbwiedergabeindex >80

Variante	Art. Nr.
2700K 730lm 7,9W 0,039A	
1800cd 0,13 kg	560712
3000K 730lm 7W 0,04A	
1800cd 0,14 kg	1001571
4000K 760lm 7,9W 0,039A	
1900cd 0,12 kg	560714

LED QPAR111
GU10

A+ Spektrum A++-E

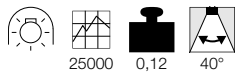

Produktangaben

220-240V ~50/60Hz
Ø: 11,1 cm

Energieverbrauch/1000h 8kWh
Farbwiedergabeindex >80

Variante	Art. Nr.
2700K 730lm 7,9W 0,039A 1800cd	
0,13 kg H: 7 cm	560722
3000K 730lm 7W 0,04A 870cd	
0,14 kg H: 7,3 cm	1001572
4000K 760lm 7,9W 0,039A 920cd	
0,12 kg H: 7 cm	560724

LED QPAR111
GU10

A+ Spektrum A++-E

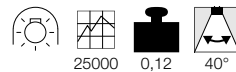

Produktangaben

220-240V ~50/60Hz
Leistung: 7,9W
Ø: 11,1 cm H: 7 cm

Energieverbrauch/1000h 8kWh
Farbwiedergabeindex >80

Variante	Art. Nr.
2700K 730lm 7,9W 0,039A 870cd	
0,12 kg H: 7 cm	560732
3000K 730lm 7W 0,04A 870cd	
0,14 kg H: 7,3 cm	1001573
4000K 760lm 7,9W 0,039A 920cd	
0,12 kg H: 7 cm	560734

LED QR111
G53

A Spektrum A++-E

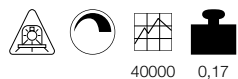

Produktangaben

12V AC
Leistung: 15W
Ø: 11,1 cm H: 6,2 cm

Lampenstrom 1,8A
Leistung 15W
Energieverbrauch/1000h 17kWh
Farbtemperatur 2700K
Farbwiedergabeindex >90

Variante	Art. Nr.
760lm 3900cd 24°	560231
750lm 1400cd 40°	560232

LED QR111
G53

A Spektrum A++-E

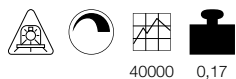

Produktangaben

12V AC
Leistung: 15W
Ø: 11,1 cm H: 6,2 cm

Lampenstrom 1,8A
Leistung 15W
Energieverbrauch/1000h 17kWh
Farbtemperatur 3000K
Farbwiedergabeindex >90

Variante	Art. Nr.
770lm 4000cd 24°	560233
760lm 1450cd 40°	560234

LED QR111
G53

A Spektrum A++-E

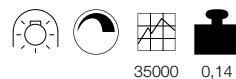

Produktangaben

12V AC
Leistung: 19,5W
Ø: 11 cm H: 6,1 cm

Lampenstrom 1,85A
Leistung 19,5W
Energieverbrauch/1000h 21kWh
Farbtemperatur 2700K
max. Lichtstärke 1625cd
Farbwiedergabeindex >80

Variante	Art. Nr.
1070lm 1625cd 30°	551402
900lm 400cd 140°	551412

LED QR111
G53

35000 0,14

Produktangaben

12V ~50Hz
Leistung: 15W
Ø: 11 cm H: 6 cm

Hinweis

Betrieb nur mit konventionellem Trafo.

Lampenstrom	1,75A
Leistung	15W
Energieverbrauch/1000h	16kWh
Farbtemperatur	2700K
Farbwiedergabeindex	>80

Variante	Art. Nr.
810lm 1230cd 30°	551602
680lm 300cd 140°	551612

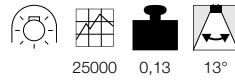
LED QR111
G53

25000 0,13 13°

Produktangaben

12V ~50Hz
Leistung: 9W
Ø: 11,1 cm H: 5,7 cm

Hinweis

Betrieb nur mit konventionellem Trafo.

Lampenstrom	1,29A
Leistung	9W
Energieverbrauch/1000h	10kWh
Lichtstrom	800lm
max. Lichtstärke	5600cd
Farbwiedergabeindex	>80

Variante	Art. Nr.
2700K	560622
4000K	560624

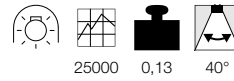
LED QR111
G53

25000 0,13 40°

Produktangaben

12V ~50Hz
Leistung: 9W
Ø: 11,1 cm H: 5,4 cm

Hinweis

Betrieb nur mit konventionellem Trafo.

Lampenstrom	1,29A
Leistung	9W
Energieverbrauch/1000h	10kWh
Lichtstrom	800lm
Farbwiedergabeindex	>80

Variante	Art. Nr.
2700K 1000cd	560662

LED C35
E14

15000 0,03 280°

Produktangaben

220-240V ~50/60Hz
Leistung: 4,5W
Ø: 3,5 cm H: 12,1 cm
Dimmbar: L, C

Lampenstrom	0,022A
Leistung	4,5W
Energieverbrauch/1000h	5kWh
Farbtemperatur	2700K
Lichtstrom	490lm
Farbwiedergabeindex	>80

Variante	Art. Nr.
	1002128

LED C35
E14

15000 0,04 280°

Produktangaben

220-240V ~50/60Hz
Leistung: 6,5W
Ø: 3,8 cm H: 11 cm
Dimmbar: L, C

Lampenstrom	0,033A
Leistung	6,5W
Energieverbrauch/1000h	7kWh
Farbtemperatur	3000K
Lichtstrom	480lm
Farbwiedergabeindex	>80

Variante	Art. Nr.
	560372

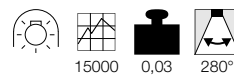
LED C35
E14

15000 0,03 280°

Produktangaben

220-240V ~50/60Hz
Leistung: 4W
Ø: 3,7 cm H: 11,3 cm

Lampenstrom	0,035A
Leistung	4W
Energieverbrauch/1000h	4kWh
Farbtemperatur	2700K
Lichtstrom	250lm
Farbwiedergabeindex	>80

Variante	Art. Nr.
	560222

LED A60
E27, CCT

A+ Spektrum A++-E



Produktangaben

220-240V ~50/60Hz
Leistung: 9W
Ø: 6 cm H: 12 cm

Hinweis

Fernsteuerbar und dimmbar mit SLV VALETO® CCT/RGBW Fernbedienung [1002994] oder Gateway [1002411]

Lampenstrom	0,052A
Leistung	9W
Energieverbrauch/1000h	9kWh
Farbtemperatur	2700K-6500K
Lichtstrom	806lm
Farbwiedergabeindex	>80

Variante	Art. Nr.
	1001916

LED A60
E27, RGBW

A+ Spektrum A++-E



Produktangaben

220-240V ~50/60Hz
Leistung: 9,5W
Ø: 6 cm H: 12 cm

Hinweis

Fernsteuerbar und dimmbar mit SLV VALETO® CCT/RGBW Fernbedienung [1002994] oder Gateway [1002411]

Lampenstrom	0,054A
Leistung	9,5W
Energieverbrauch/1000h	10kWh
Farbtemperatur	RGBW
Lichtstrom	806lm
Farbwiedergabeindex	>80

Variante	Art. Nr.
	1001917

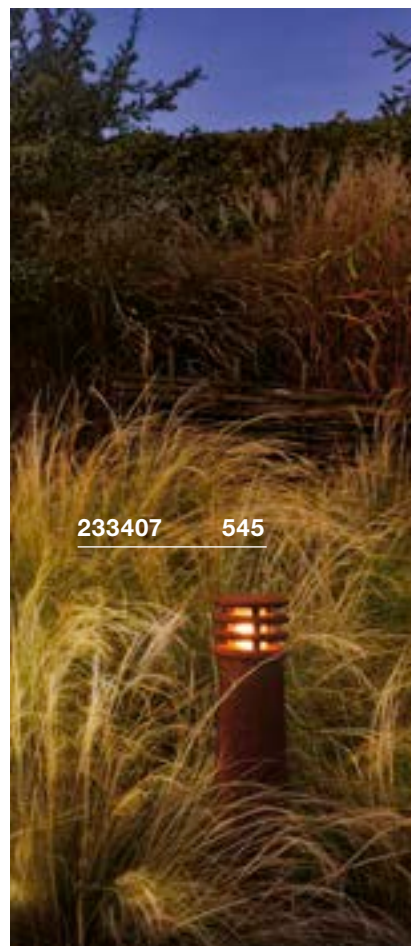

LED A60
E27

A+ Spektrum A++-E

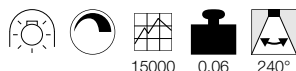

Produktangaben

220-240V ~50/60Hz
Leistung: 9,1W
Ø: 6 cm H: 11 cm
Dimmbar: L, C

Lampenstrom	0,043A
Leistung	9,1W
Energieverbrauch/1000h	10kWh
Farbtemperatur	2700K
Lichtstrom	760lm
Farbwiedergabeindex	>80

Variante	Art. Nr.
	560402

LED A60
E27

A+ Spektrum A++-E



Produktangaben

220-240V ~50/60Hz
Leistung: 14,5W
Ø: 6 cm H: 12,2 cm
Dimmbar: L, C

Lampenstrom	0,064A
Leistung	14,5W
Energieverbrauch/1000h	15kWh
Farbtemperatur	2700K
Lichtstrom	1521lm
Farbwiedergabeindex	>80

Variante	Art. Nr.
	560422

LED T45
E27

A+ Spektrum A++-E

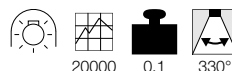

Produktangaben

230V ~50Hz
Leistung: 4,7W
Ø: 4,5 cm H: 13,9 cm

Lampenstrom	0,037A
Leistung	4,7W
Energieverbrauch/1000h	5kWh
Farbtemperatur	3000K
Lichtstrom	380lm
Farbwiedergabeindex	>80

Variante	Art. Nr.
	551532



LED T38 E27

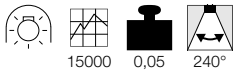

Produktangaben

100-240V ~50/60Hz
Leistung: 9W
Ø: 3,8 cm H: 11,5 cm

Lampenstrom	0,046A
Leistung	9W
Energieverbrauch/1000h	10kWh
Farbwiedergabeindex	>80

Variante	Art. Nr.
3000K 810lm	1001031
4000K 850lm	1002827

LED T45 E27

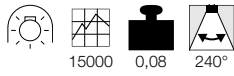

Produktangaben

100-240V ~50/60Hz
Leistung: 12W
Ø: 4,5 cm H: 13,6 cm

Lampenstrom	0,052A
Leistung	12W
Energieverbrauch/1000h	12kWh
Farbtemperatur	3000K
Lichtstrom	1060lm
Farbwiedergabeindex	>80

Variante	Art. Nr.
	1001032

LED T45 E27

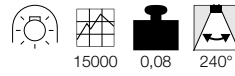

Produktangaben

100-240V ~50/60Hz
Leistung: 15W
Ø: 4,5 cm H: 13,6 cm

Lampenstrom	0,063A
Leistung	15W
Energieverbrauch/1000h	15kWh
Farbwiedergabeindex	>80

Variante	Art. Nr.
3000K 1521lm	1001033
4000K 1600lm	1002828

LED A60 E27

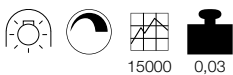

Produktangaben

220-240V ~50/60Hz
Leistung: 7W
Ø: 6 cm L: 10,5 cm
Dimmbar: C, L

Lampenstrom	0,032A
Leistung	7W
Energieverbrauch/1000h	7kWh
Farbtemperatur	2700K
Lichtstrom	810lm
Farbwiedergabeindex	>80

Variante	Art. Nr.
	1003090

LED FRISBEE E27

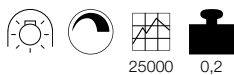

Produktangaben

220-240V ~50/60Hz
Leistung: 10,5W
Ø: 19,2 cm L: 11,8 cm
Dimmbar: C

Lampenstrom	0,055A
Leistung	10,5W
Energieverbrauch/1000h	10,5kWh
Farbtemperatur	2700K
Lichtstrom	1000lm
Farbwiedergabeindex	>80

Variante	Art. Nr.
	1003093

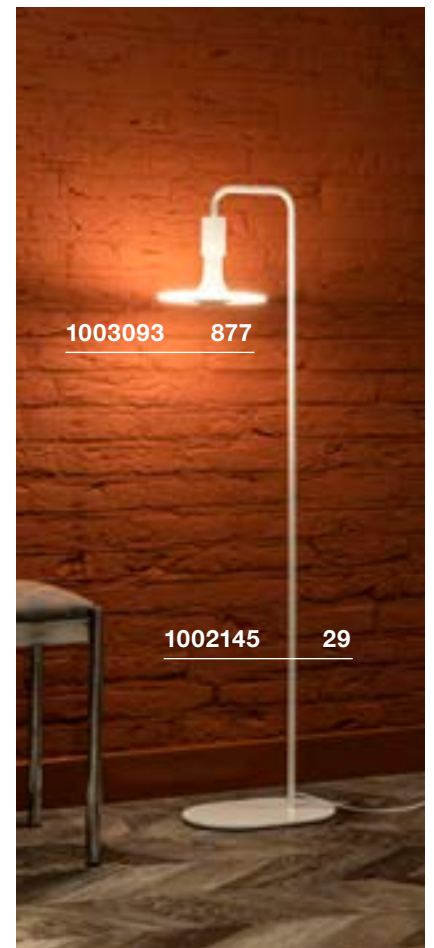

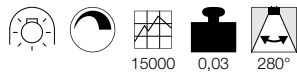
LED A60
E27A++ Spektrum
A++-E

Produktangaben

220-240V ~50/60Hz
Leistung: 4,5W
Ø: 6 cm H: 10,5 cm
Dimmbar: L, C

Lampenstrom	0,022A
Leistung	4,5W
Energieverbrauch/1000h	5kWh
Farbtemperatur	2700K
Lichtstrom	530lm
Farbwiedergabeindex	>80

Variante	Art. Nr.
	1002123

LED A60
E27A++ Spektrum
A++-E

NEW

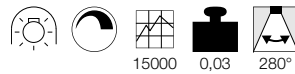

Produktangaben

220-240V ~50/60Hz
Leistung: 7W
Ø: 6 cm H: 10,5 cm
Dimmbar: L, C

Lampenstrom	0,031A
Leistung	7W
Energieverbrauch/1000h	7kWh
Farbtemperatur	2700K
Lichtstrom	790lm
Farbwiedergabeindex	>80

Variante	Art. Nr.
	1002124

LED A60
E27A++ Spektrum
A++-E

SWITCH DIM



Produktangaben

220-240V ~50/60Hz
Leistung: 7W
Ø: 6 cm H: 10,5 cm
Dimmbar: Switch

Lampenstrom	0,053A
Leistung	7W
Energieverbrauch/1000h	7kWh
Farbtemperatur	2700K
Lichtstrom	790lm
Farbwiedergabeindex	>80

Variante	Art. Nr.
	1002127

LED A60
E27A++ Spektrum
A++-E

DIM TO WARM



Produktangaben

220-240V ~50/60Hz
Leistung: 4,5W
Ø: 6 cm H: 11,4 cm
Dimmbar: L, C

Lampenstrom	0,022A
Leistung	4,5W
Energieverbrauch/1000h	5kWh
Farbtemperatur	2200-2700K
Lichtstrom	500lm
Farbwiedergabeindex	>80

Variante	Art. Nr.
	1002125

LED A60
E27A++ Spektrum
A++-E

DIM TO WARM

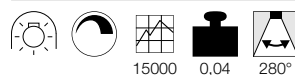

Produktangaben

220-240V ~50/60Hz
Leistung: 7W
Ø: 6 cm H: 11,4 cm
Dimmbar: L, C

Lampenstrom	0,031A
Leistung	7W
Energieverbrauch/1000h	7kWh
Farbtemperatur	2200-2700K
Lichtstrom	830lm
Farbwiedergabeindex	>80

Variante	Art. Nr.
	1002126

LED A60
E27A+ Spektrum
A++-E

NEW

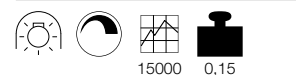

Produktangaben

220-240V ~50/60Hz
Leistung: 15W
Ø: 9 cm L: 23 cm
Dimmbar: C

Lampenstrom	0,09A
Leistung	15W
Energieverbrauch/1000h	15kWh
Farbtemperatur	2700K
Lichtstrom	1600lm
Farbwiedergabeindex	>90

Variante	Art. Nr.
	1003097



LED ST58
E27



Produktangaben

220-240V ~50/60Hz
Leistung: 7,1W
Ø: 5,8 cm H: 12,8 cm
Dimmbar: L, C

Lampenstrom	0,035A
Leistung	7,1W
Energieverbrauch/1000h	8kWh
Farbtemperatur	2700K
Lichtstrom	806lm
Farbwiedergabeindex	>80

Variante	Art. Nr.
	1001756

LED ST64
E27



Produktangaben

220-240V ~50/60Hz
Leistung: 5W
Ø: 6,4 cm H: 14,5 cm

Lampenstrom	0,043A
Leistung	5W
Energieverbrauch/1000h	5kWh
Farbtemperatur	2000K
Lichtstrom	500lm
Farbwiedergabeindex	>80

Variante	Art. Nr.
	560741

LED T32
E27



Produktangaben

220-240V ~50/60Hz
Leistung: 8W
Ø: 3,2 cm H: 18,5 cm

Lampenstrom	0,03A
Leistung	8W
Energieverbrauch/1000h	8kWh
Farbtemperatur	2200K
Lichtstrom	250lm
Farbwiedergabeindex	>95

Variante	Art. Nr.
	1003100

LED A60
E27, Mirrorhead, Chrome

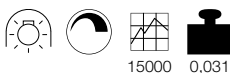

Produktangaben

220-240V ~50/60Hz
Leistung: 7W
Ø: 6 cm H: 10,5 cm
Dimmbar: L, C

Lampenstrom	0,032A
Leistung	7W
Energieverbrauch/1000h	7kWh
Farbtemperatur	2700K
Lichtstrom	640lm
Farbwiedergabeindex	>80

Variante	Art. Nr.
	1003085

LED A60
E27, Mirrorhead, Gold



Produktangaben

220-240V ~50/60Hz
Leistung: 4W
Ø: 6 cm L: 10,6 cm
Dimmbar: C

Lampenstrom	0,02A
Leistung	4W
Energieverbrauch/1000h	4kWh
Farbtemperatur	2000-2900K
Lichtstrom	200lm
Farbwiedergabeindex	>90

Variante	Art. Nr.
	1003098

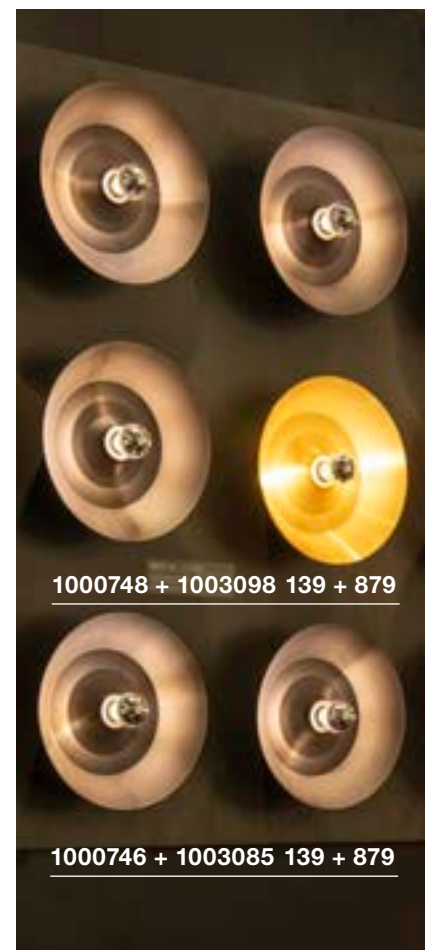

LED G95/G125
E27

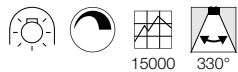

Produktangaben

220-240V ~50/60Hz
Leistung: 7W
Dimmbar: L, C

Lampenstrom	0,043A
Leistung	7W
Energieverbrauch/1000h	8kWh
Farbtemperatur	2700K
Lichtstrom	806lm
Farbwiedergabeindex	>80

Variante	Art. Nr.
Ø: 9,5 cm H: 13,2 cm 0,06 kg	1001035
Ø: 12,5 cm H: 17,8 cm 0,1 kg	1001038

LED G95/G125
E27, Rauchglas



Produktangaben

220-240V ~50/60Hz
Leistung: 7W
Dimmbar: C

Lampenstrom	0,032A
Leistung	7W
Energieverbrauch/1000h	7kWh
Farbtemperatur	2700K
Farbwiedergabeindex	>80

Variante	Art. Nr.
360lm Ø: 9,5 cm H: 13,5 cm 0,054 kg	1003091
440lm Ø: 12,4 cm H: 16,8 cm 0,124 kg	1003092

LED G125
E27

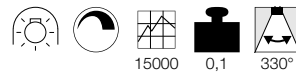

Produktangaben

220-240V ~50/60Hz
Leistung: 7W
Ø: 12,5 cm H: 17,8 cm
Dimmbar: L, C

Lampenstrom	0,043A
Leistung	7W
Energieverbrauch/1000h	8kWh
Farbtemperatur	2700K
Lichtstrom	630lm
Farbwiedergabeindex	>80

Variante	Art. Nr.
	1001357

LED G125
E27, Mirrorhead, gold

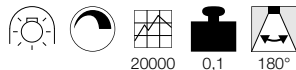

Produktangaben

220-240V ~50/60Hz
Leistung: 8W
Ø: 12,5 cm H: 18 cm

Lampenstrom	0,04A
Leistung	8W
Energieverbrauch/1000h	8kWh
Farbtemperatur	2000-2900K
Lichtstrom	400lm
Farbwiedergabeindex	>90

Variante	Art. Nr.
	1003099

LED G125
E27, Rauchglas

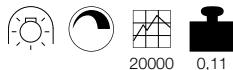

Produktangaben

220-240V ~50/60Hz
Leistung: 8W
Ø: 12,5 cm H: 18 cm

Lampenstrom	0,032A
Leistung	8W
Energieverbrauch/1000h	8kWh
Farbtemperatur	2000-2900K
Lichtstrom	500lm
Farbwiedergabeindex	>90

Variante	Art. Nr.
	1003096





LED PAR30 E27

A+ Spektrum A++-E

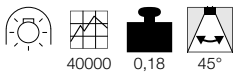

Produktangaben

220-240V ~50/60Hz
Leistung: 11W
Ø: 9,5 cm H: 11,6 cm

Lampenstrom	0,051A
Leistung	11W
Energieverbrauch/1000h	11kWh
Farbtemperatur	3000K
Lichtstrom	900lm
max. Lichtstärke	1300cd
Farbwiedergabeindex	>80

Variante	Art. Nr.
	560463

LED PAR38 E27

A+ Spektrum A++-E

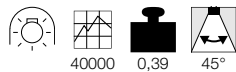

Produktangaben

220-240V ~50/60Hz
Leistung: 17W
Ø: 12,2 cm H: 13,5 cm

Lampenstrom	0,079A
Leistung	17W
Energieverbrauch/1000h	17kWh
Farbtemperatur	3000K
Lichtstrom	1430lm
max. Lichtstärke	1630cd
Farbwiedergabeindex	>80

Variante	Art. Nr.
	560473

LED TCR-TSE GX53

A++ Spektrum A++-E

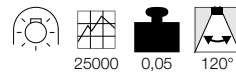

Produktangaben

230V ~50Hz
Leistung: 3W
Ø: 7,6 cm H: 2,6 cm

Lampenstrom	0,03A
Leistung	3W
Energieverbrauch/1000h	3kWh
Farbtemperatur	3000K
Lichtstrom	250lm
Farbwiedergabeindex	>80

Variante	Art. Nr.
	551372

LED TCR-TSE GX53

A Spektrum A++-E

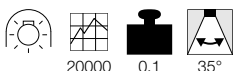

Produktangaben

230V ~50Hz
Leistung: 4,2W
Ø: 7,5 cm H: 3,5 cm

Lampenstrom	0,041A
Leistung	4,2W
Energieverbrauch/1000h	5kWh
Farbtemperatur	3000K
Lichtstrom	200lm
max. Lichtstärke	550cd
Farbwiedergabeindex	>80

Variante	Art. Nr.
	550092

LED TCR-TSE GX53

A Spektrum A++-E

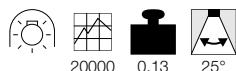

Produktangaben

230V ~50Hz
Leistung: 7,5W
Ø: 7,6 cm H: 3,5 cm

Lampenstrom	0,037A
Leistung	7,5W
Energieverbrauch/1000h	8kWh
Farbtemperatur	3000K
Lichtstrom	450lm
max. Lichtstärke	1235cd
Farbwiedergabeindex	>80

Variante	Art. Nr.
	550082

LED TCR-TSE GX53

A+ Spektrum A++-E

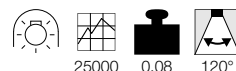

Produktangaben

220-240V ~50/60Hz
Leistung: 8,2W
Ø: 7,5 cm H: 2,9 cm

Lampenstrom	0,062A
Leistung	8,2W
Energieverbrauch/1000h	9kWh
Farbwiedergabeindex	>80

Variante	Art. Nr.
3000K 600lm	550073
4000K 620lm	550074

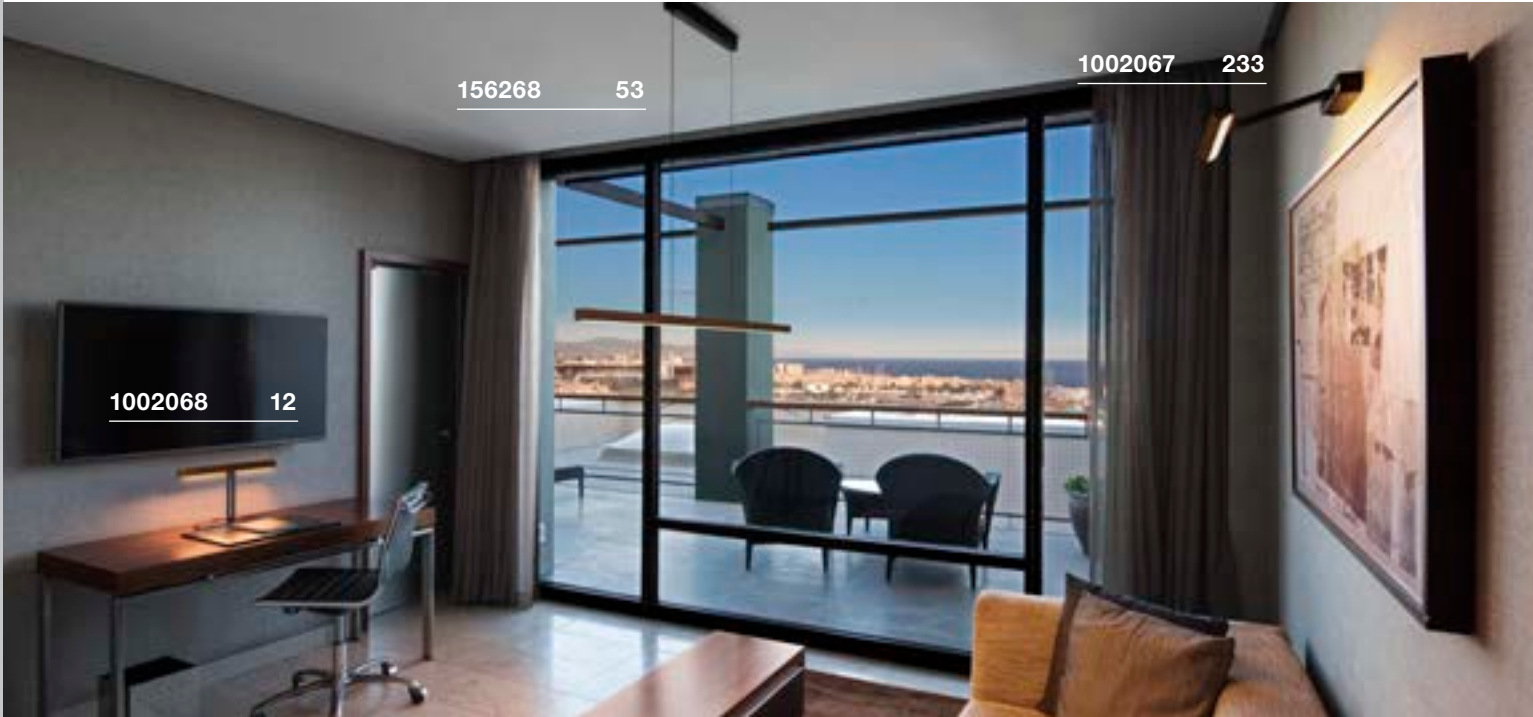

FAMILIENSACHE: UNSERE SLV LEUCHTENFAMILIEN.

Gerade wenn eine optische Durchgängigkeit gewünscht ist, eignen sich unsere Leuchtenfamilien hervorragend, um verschiedene Räume oder Raumsituationen einheitlich zu gestalten und dabei trotzdem vielfältig zu bleiben.

ABRIDOR



ACCANTO



ADEGAN MANILA





AIXLIGHT®

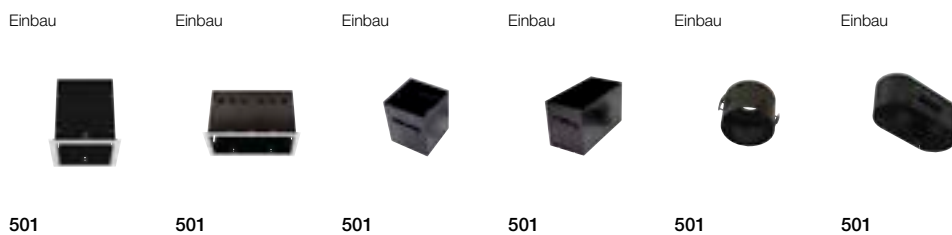
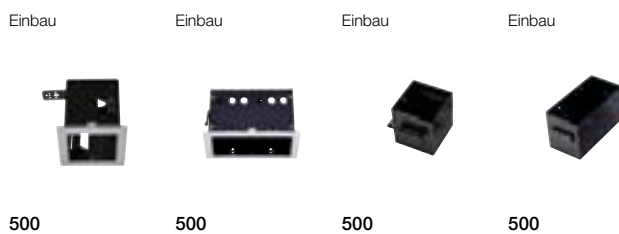

AIXLIGHT® R2

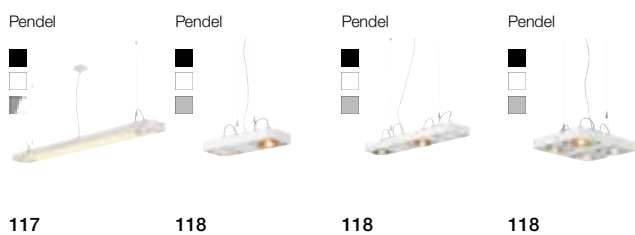

ALMINO

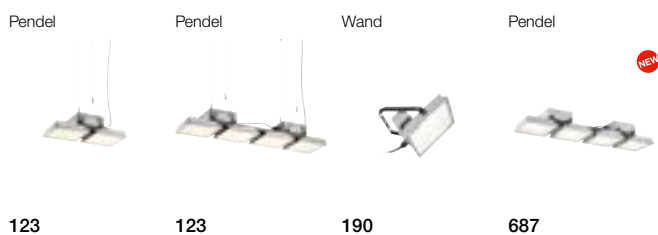

ALTRA DICE

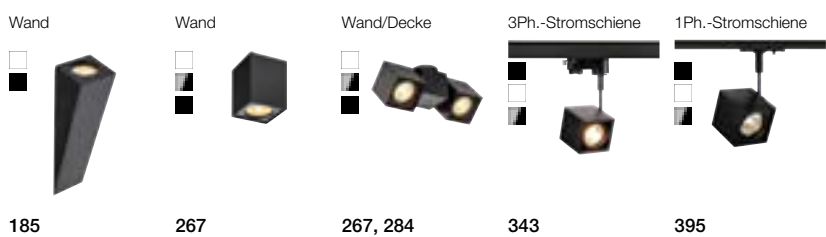

ANELA

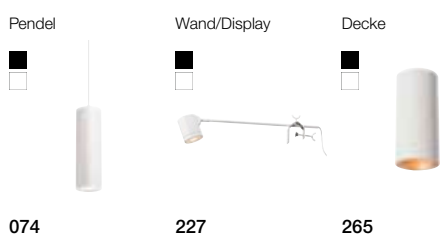



APONI































ASTINA

Pendel	Wand	Decke	Wand	Wand	Wand
					
					
069	177	264	654	655	655

AVO







Wand/Decke	Wand/Decke	Wand/Decke	Wand/Decke	3Ph.-Stromschiene	1Ph.-Stromschiene
					
					
299	299	299	299	343	387

BATO

Pendel	Pendel	Pendel	Pendel
			
			
058	058	058	059
Wand	Wand	Decke	Decke
			
			
139	139	238	238

BENDO



Wege/Stand	Wege/Stand	Wand
		
		
572	572	636

BIG NAILS

Wege/Stand	Wege/Stand	Wege/Stand	Wand
			
			
551	552	552	619

BIG THEO

Wand	Wand	Decke
		
		
650	665	678



BIG THEO LED



BILAS
Design:
Vincent de Smedt

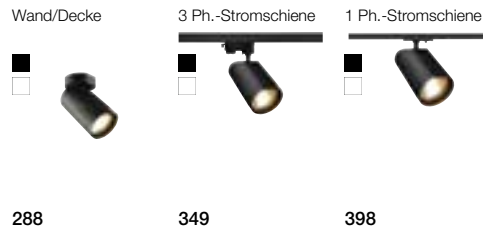

BIMA

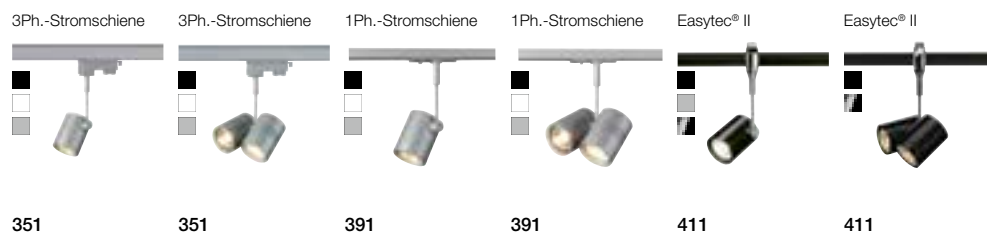

BISHADE

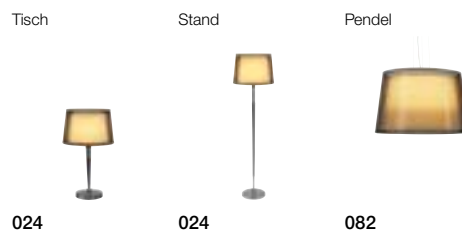

BRENDA

Design:
Johannes Tomm



ENOLA B































ENOLA C

Decke  266	Decke  266	3Ph.-Stromschiene  346	1Ph.-Stromschiene  397	Wege/Stand  577	Wand  628	Wand  656
Wand/Decke  675	Wand/Decke  675	ESKINA		Wege/Stand  577	Wand  670	Wand  689

EURO SPOT

3Ph.-Stromschiene  334	3Ph.-Stromschiene  334	3Ph.-Stromschiene  335	3Ph.-Stromschiene  360	3Ph.-Stromschiene  360	
3Ph.-Stromschiene  361	3Ph.-Stromschiene  361	3Ph.-Stromschiene  361	1Ph.-Stromschiene  392	1Ph.-Stromschiene  392	1Ph.-Stromschiene  393

FENDA
MIX & MATCH

Tisch  018	Stand  018	Tisch  020	Stand  020	Stand  022	
Pendel  044	Wand  148	Wand  192	Wand  193	Decke  234	
Schirme  018, 020, 046	Schirme  019, 021, 022, 047, 235	Schirme  022, 044	Schirme  044	Schirme  148	Schirme  192



FITU
MIX & MATCH

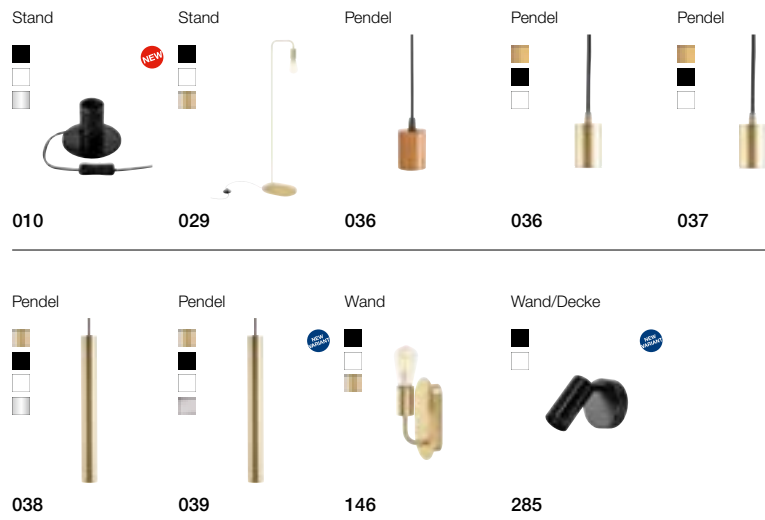

FLATT



FORCHINI



F-POL



GLOO PURE

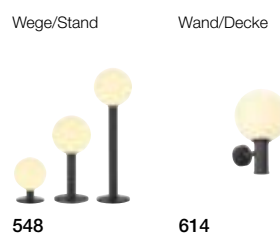

GRAFIT

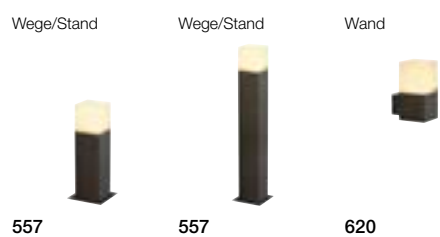



HELIA

Pendel	Pendel	Pendel	Pendel	Wand/Decke	Wand/Decke
072	072	073	073	292	292

3Ph.-Stromschiene	1Ph.-Stromschiene	Easytec® II	Einbau
346	397	410	447

Wege/Stand	Wege/Stand	Wege/Stand	Wege/Stand	Wege/Stand
580	580	581	583	583

Strahler	Strahler	Wand	Wand	Wand	Wand
599	599	629	653	691	691

IPERI

Wege/Stand	Wand
575	642

KALU LED

Wand/Decke	Wand/Decke	Wand/Decke	Wand/Decke	Wand/Decke	Wand/Decke
306	306	306	307	307	307

3Ph.-Stromschiene	3Ph.-Stromschiene	1Ph.-Stromschiene
359	359	395



**KALU
QPAR111**

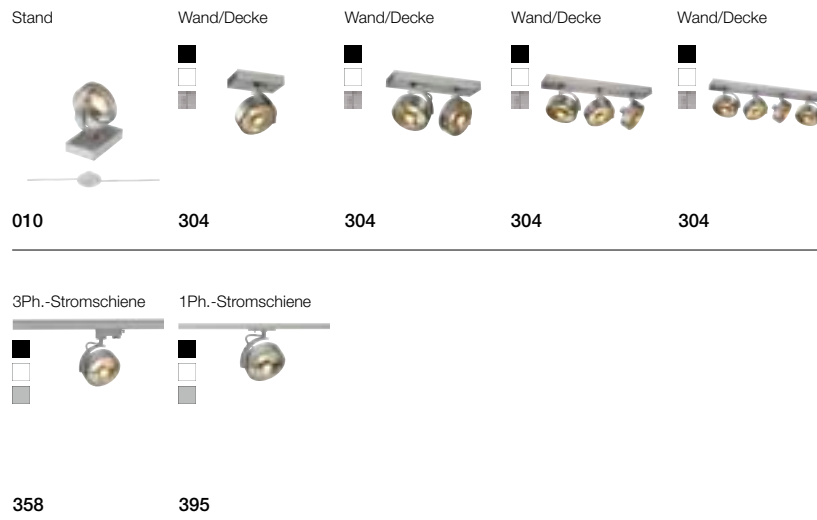

KARPO

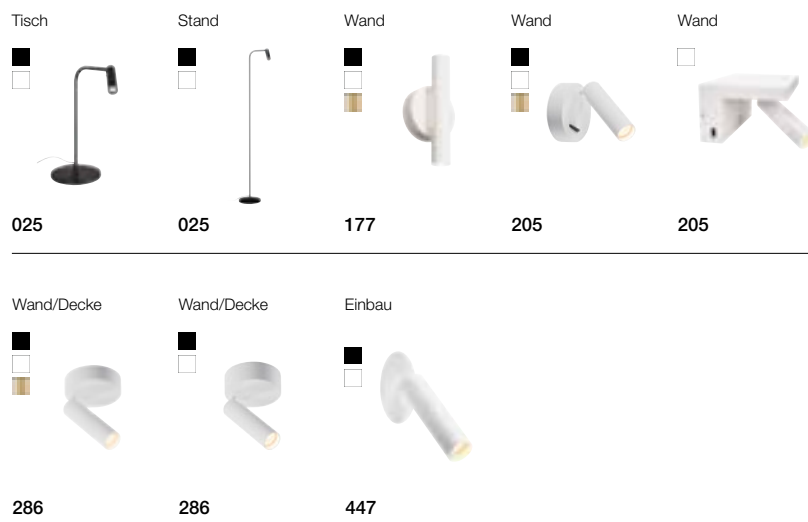

LASSON



LED SAIL

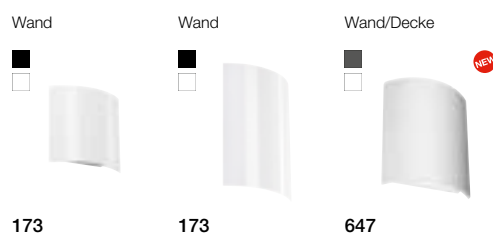

LENITO

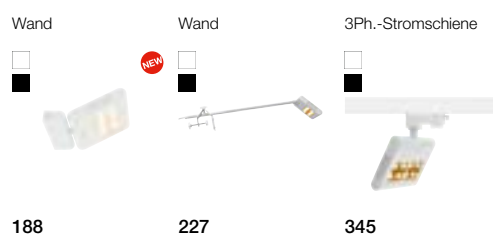



LIGHT EYE 150



LIGHT EYE 90

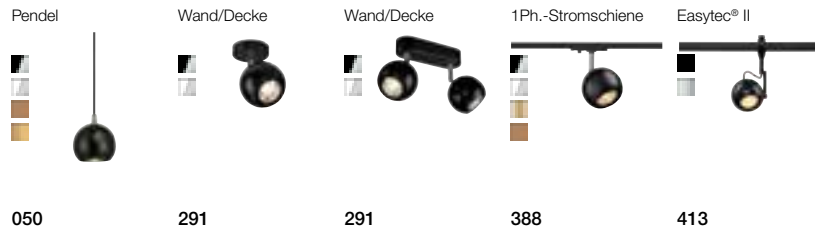

LIGHT PIPE

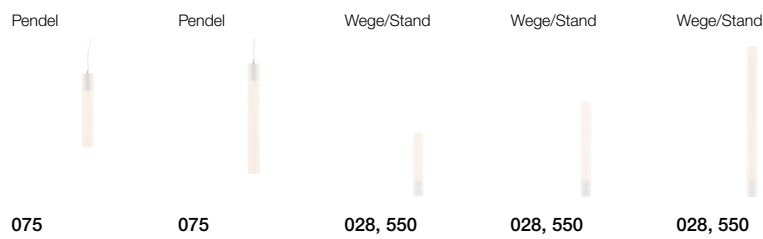

LISENNE



LOGS



LYNAH



MAGANDA

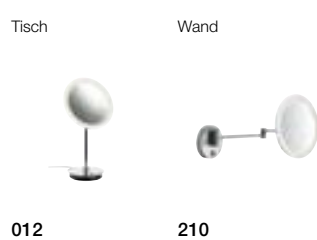









MALU





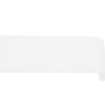











MANA





Wand 	Schirm 	Schirm 	Wand 	Schirm 	Schirm 	Schirm 
150	151	151	152	153, 199	153, 199	153, 199



Wand 	Wand 
198	660

MEDO LED

Pendel/Decke 	Pendel/Decke 	Pendel/Decke 	Pendel/Decke 	Pendel/Decke 	Pendel/Decke 	Pendel/Decke 
090, 246	091, 247	092, 248	092, 248	092, 248	093, 249	094, 250, 321

Pendel/Decke 	Pendel/Decke 	Pendel/Decke 	Pendel/Decke 	Pendel/Decke 	Pendel/Decke 	Pendel/Decke 
095, 251, 321	095, 251, 321	095, 251	096, 252	096, 252	096, 252	097, 253

Pendel/Decke 	Pendel/Decke 	Pendel 	Pendel 	Pendel 
098, 254	099, 255	100	100	101

Einbau 	Einbau 
518, 519	520, 521

MERADO FLOOD

Wand 	3Ph.-Stromschiene 
189	345

MOLAT

Pendel 	Wege/Stand 	Wand 	Decke 
532	550	614	672



MYRA

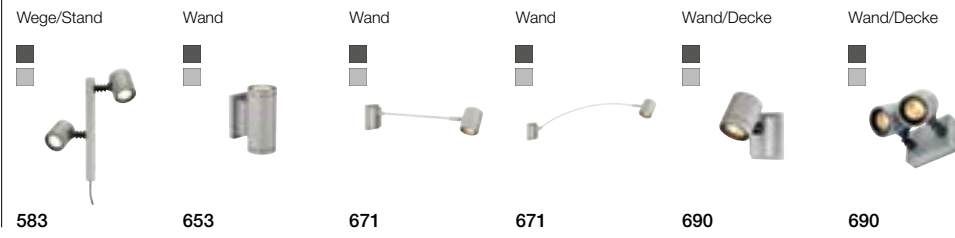

NAUTILUS

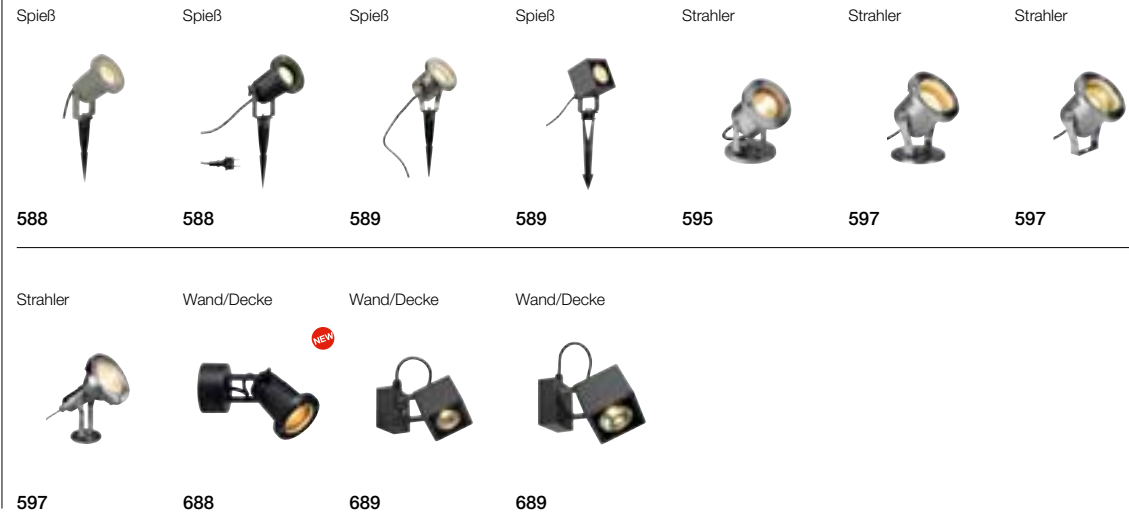

NOBLO

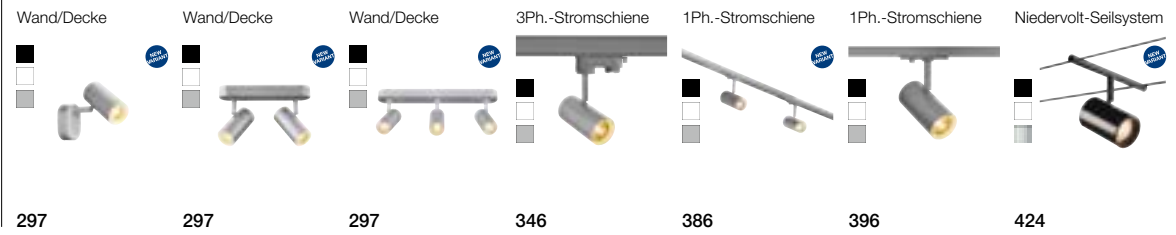

OCCULDAS

Design: David Morgan



ONE

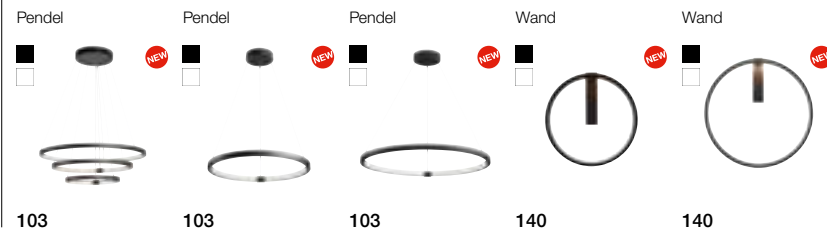

OPEN GRILL

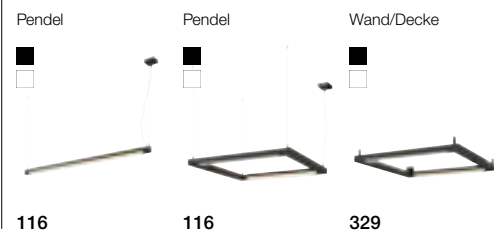



PARA CONE

Pendel 	Pendel 	Pendel 	3Ph.-Stromschiene 	3Ph.-Stromschiene 	1Ph.-Stromschiene 	1Ph.-Stromschiene
066	066	066	344	363	389	400

PHELIA
Design:
Markus Becker

Tisch 	Standeuchte 	Pendel 	Pendel 	Pendel 	Pendel 	Wand
026	026	056	057	057	057	203

PHOTONIA

Pendel 	Tisch 	Wege/Stand 	Wand 	Decke
532	541	547	614	672

PLASTRA

Pendel 	Pendel 	Pendel 	Pendel 	Wand 	Wand 	Wand
048	049	049	070	137	137	154
Wand 	Wand 	Wand 	Wand 	Wand 	Wand 	Wand
155	159	159	170	174	174	175
Wand 	Wand 	Wand 	Decke 	Decke 	Decke 	Decke
180	180	180	240	240	240	272
Decke 	Decke 	Decke 	Einbau 	Einbau 		
272	273	273	453	453		



P-LIGHT



POLE PARC



PURI



Q-LINE

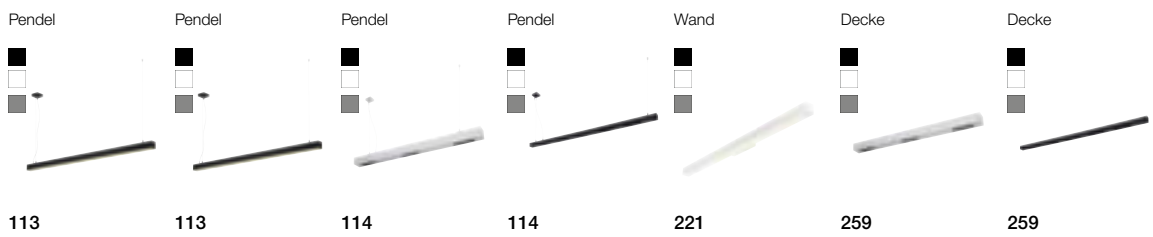

QUAD



QUADRASYL

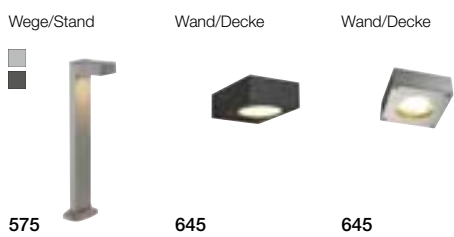



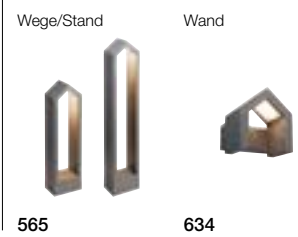







RASCALI













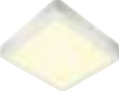

ROTOBALL

Pendel	Pendel	Pendel	Decke	Decke
				
080	080	080	260	260
Pendel	Pendel	Stand	Stand	Stand
				
533	533	538	538	538



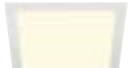

ROX

Wand	Wand	Decke	Wege/Stand	Wege/Stand	Wege/Stand
					
178, 630	178, 656	266, 676	553	553	553
Decke	Decke				
					
676	676				

SENSER

Wand/Decke	Wand/Decke	Wand/Decke	Wand/Decke	Wand/Decke	Wand/Decke
					
324	324	324	325	325	325
Einbau	Einbau	Einbau	Einbau	Einbau	Einbau
					
510	510	510	511	511	511

SIGHT LED

Wand/Decke	Wand/Decke	3Ph.-Stromschiene	3Ph.-Stromschiene	3Ph.-Stromschiene
				
328	328	337	349	362



SITRA

Wege/Stand 582	Spieß 591	Spieß 591	Wand 629	Wand 629	Wand 654	Wand 654
Wand 663	Wand 663	Decke 674	Wand/Decke 690			

SLOTS

Wege/Stand 563	Wege/Stand 563	Wand 616
-----------------------	-----------------------	-----------------

SOPRANA

Pendel 082	Wand 147	Wand 149	Decke 237
-------------------	-----------------	-----------------	------------------

SPOT E27

Wand 225	Wand/Decke 282	3Ph.-Stromschiene 342	1Ph.-Stromschiene 388
-----------------	-----------------------	------------------------------	------------------------------

SQUARE

Wege/Stand 559	Wege/Stand 559	Wege/Stand 559	Wand 620	Wand 620	Wand 657
Decke 677	Decke 677				



STRUCTEC

3Ph.-Stromschiene	3Ph.-Stromschiene	3Ph.-Stromschiene	3Ph.-Stromschiene	3Ph.-Stromschiene	1Ph.-Stromschiene
336	356	356	356	357	398

SUPROS

Pendel	Decke	3Ph.-Stromschiene	Einbau	Einbau	
125	277	355	506	507	

SUPROS 78

Pendel	Wand	Decke	3Ph.-Stromschiene	Einbau	Einbau
124	179	277	354	504	505

TEC KALU

Wand/Decke	Wand/Decke	3Ph.-Stromschiene	3Ph.-Stromschiene
268	268	352	352

TENORA

Wand	Decke
191	237

THEO

Wand	Wege/Stand	Wege/Stand	Wand	Wand	Decke
161	578	578	650	665	678

TONGA

Pendel	1Ph.-Stromschiene	Easytec® II
077	400	414

TOTHEE

Wand/Decke	2Ph.-Stromschiene
287	378



TRAPECCO

Wege/Stand

Wand



576



644

TRUST

Wege/Stand

Wege/Stand

Wand



551



551



619

VINCELLI D

Tisch

Pendel

Wand

Wand



012



053



223



223

WORKLIGHT

Stand

Stand

Pendel

Pendel



030

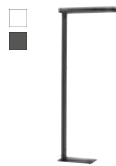

031



120

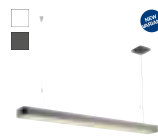

121



1000681 617

1000683 549

Hinweis: 7-stellige Art. Nr. finden Sie ab Sei e 906

111000	113450.....	483	114261.....	495	115556.....	497
111260.....	113451.....	483	114270.....	495	115600.....	501
111262.....	113456.....	483	114271.....	495	115624.....	501
111290.....	113490.....	485	114280.....	495	115634.....	501
111292.....	113491.....	485	114281.....	495	115700.....	498
111360.....	113492.....	486	114290.....	495	115701.....	498
111361.....	113510.....	485	114291.....	495	115706.....	498
111362.....	113511.....	485	114380.....	490	115710.....	498
111380.....	113512.....	486	114381.....	490	115711.....	498
111381.....	113540.....	487	114386.....	490	115716.....	498
111382.....	113541.....	487	114390.....	490	115720.....	498
111482.....	113550.....	487	114391.....	490	115721.....	498
111710.....	113830.....	487	114396.....	490	115726.....	498
111711.....	113840.....	487	114400.....	488	115730.....	499
111716.....	113841.....	487	114401.....	488	115731.....	499
111720.....	113870.....	492	114406.....	488	115736.....	499
111721.....	113871.....	492	114420.....	467, 711	115740.....	499
111726.....	113876.....	492	114421.....	467, 711	115741.....	499
111830.....	113880.....	492	114426.....	467, 711	115746.....	499
111831.....	113881.....	492	114430.....	467, 711		
111832.....	113886.....	492	114431.....	467, 711	116000	
111833.....	113890.....	493	114436.....	467, 711	116302.....	124
111850.....	113891.....	493	114440.....	465, 709	116304.....	124
111860.....	113896.....	493	114441.....	465, 709	116310.....	504
111861.....	113900.....	492	114445.....	465, 709	116311.....	504
111862.....	113901.....	492	114451.....	465, 709	116320.....	505
	113906.....	492	114460.....	708	116321.....	505
112000	113910.....	492	114461.....	708	116330.....	277
112161.....	113911.....	492	114470.....	708	116331.....	277
112162.....	113916.....	492	114471.....	708	116340.....	179
112165.....	113920.....	493	114480.....	458	116341.....	179
112221.....	113921.....	493	114481.....	458		
112222.....	113926.....	493	114490.....	458	117000	
112225.....	113930.....	271	114491.....	458	117100.....	274
112240.....	113931.....	271	114500.....	459	117101.....	274
112242.....	113936.....	271	114501.....	459	117110.....	274
112471.....	113940.....	271			117111.....	274
112474.....	113941.....	271	115000		117120.....	275
112682.....	113946.....	271	115011.....	501	117121.....	275
112692.....	113951.....	489	115014.....	501	117130.....	275
112702.....	113956.....	489	115104.....	501	117131.....	275
112720.....	113961.....	489	115114.....	501	117160.....	276
112721.....	113966.....	489	115151.....	501	117161.....	276
112726.....	113970.....	488	115152.....	501	117180.....	276
112731.....	113971.....	488	115183.....	502	117181.....	276
112732.....	113976.....	488	115193.....	502	117311.....	469
112771.....			115203.....	503	117321.....	263
112772.....	114000		115213.....	503	117331.....	469
112780.....	114102.....	125	115223.....	503	117341.....	469
112781.....	114104.....	125	115233.....	503	117351.....	262
112910.....	114110.....	506	115243.....	503	117361.....	263
112911.....	114111.....	506	115253.....	503	117381.....	263
	114120.....	507	115304.....	500		
113000	114121.....	507	115314.....	500	118000	
113110.....	114130.....	277	115351.....	500	118110.....	506
113111.....	114131.....	277	115352.....	500	118111.....	506
113140.....	114160.....	506	115414.....	500	118120.....	507
113141.....	114161.....	506	115510.....	496	118121.....	507
113150.....	114170.....	507	115511.....	496	118130.....	277
113151.....	114171.....	507	115516.....	496	118131.....	277
113160.....	114180.....	277	115520.....	496	118160.....	506
113161.....	114181.....	277	115521.....	496	118161.....	506
113170.....	114220.....	494	115526.....	496	118170.....	507
113171.....	114221.....	494	115530.....	496	118171.....	507
113260.....	114230.....	494	115531.....	496	118180.....	277
113262.....	114231.....	494	115536.....	496	118181.....	277
113290.....	114240.....	495	115540.....	497		
113292.....	114241.....	495	115541.....	497	132000	
113440.....	114250.....	495	115546.....	497	132020.....	283
113441.....	114251.....	495	115550.....	497	132021.....	283
113446.....	114260.....	495	115551.....	497	132024.....	283

132600.....	040	134323.....	315	140221.....	378	143380.....	405
132601.....	040	134333.....	315	140240.....	378	143381.....	405
132605.....	040	134343.....	315	140241.....	378	143382.....	405
132610.....	040			140243.....	378	143390.....	388
132611.....	040	135000		140250.....	378	143391.....	388
132615.....	040	135020.....	090, 246	140251.....	378	143392.....	388
132620.....	040	135021.....	090, 246	140260.....	378	143430.....	391
132621.....	040	135024.....	090, 246	140261.....	378	143431.....	391
132625.....	040	135026.....	090, 246			143432.....	391
132650.....	036	135070.....	091, 247	143000		143440.....	391
132651.....	036	135071.....	091, 247	143010.....	404	143441.....	391
132660.....	044	135074.....	091, 247	143011.....	404	143442.....	391
132661.....	044	135076.....	091, 247	143012.....	404	143450.....	387
132662.....	044	135120.....	092, 248	143020.....	404	143451.....	387
132670.....	858	135121.....	092, 248	143021.....	404	143454.....	387
132671.....	858	135124.....	092, 248	143022.....	404	143540.....	395
132680.....	858	135126.....	092, 248	143030.....	405	143541.....	395
132681.....	858	135170.....	093, 249	143031.....	405	143544.....	395
132690.....	037	135171.....	093, 249	143032.....	405	143560.....	398
132691.....	037	135174.....	093, 249	143040.....	405	143561.....	398
132832.....	542	135176.....	093, 249	143041.....	405	143580.....	397
132835.....	542	135250.....	067	143042.....	405	143581.....	397
		135251.....	067	143050.....	405	143594.....	400
133000		135254.....	067	143051.....	405	143620.....	399
133001.....	066			143052.....	405	143621.....	399
133005.....	066	138000		143060.....	405	143731.....	395
133009.....	066	138980.....	429, 847	143061.....	405	143801.....	393
133011.....	066	138981.....	429, 847	143062.....	405	143804.....	393
133015.....	066	138982.....	429, 847	143070.....	405	143811.....	392
133019.....	066	138990.....	429, 847	143071.....	405	143814.....	392
133050.....	066	138991.....	429, 847	143072.....	405	143930.....	401
133060.....	066	138992.....	429, 847	143080.....	405	143931.....	401
133070.....	066			143081.....	405	143932.....	401
133100.....	125	139000		143082.....	405	143941.....	397
133101.....	125	139004.....	428	143090.....	405	143951.....	397
133110.....	125	139006.....	429	143091.....	405	143960.....	399
133111.....	125	139024.....	428	143092.....	405	143961.....	399
133120.....	124	139026.....	428	143100.....	405	143964.....	399
133121.....	124	139030.....	428	143101.....	405	143990.....	400
133140.....	125	139031.....	428	143102.....	405	143991.....	400
133141.....	125	139040.....	428	143110.....	405		
133150.....	125	139041.....	428	143111.....	405	144000	
133151.....	125	139050.....	428	143112.....	405	144010.....	388
133300.....	056	139051.....	428	143120.....	040	144011.....	388
133310.....	057	139060.....	429	143121.....	040	144013.....	388
133320.....	057	139061.....	429	143124.....	040	144019.....	388
133330.....	057	139070.....	420	143130.....	405	144200.....	387
133341.....	068	139071.....	420	143131.....	405	144201.....	387
133351.....	068	139072.....	420	143132.....	405	144204.....	387
133444.....	077	139080.....	420	143151.....	405		
133464.....	077	139081.....	420	143152.....	402	145000	
133481.....	050	139082.....	420	143160.....	405	145100.....	369
133482.....	050	139090.....	421	143161.....	405	145102.....	369
133483.....	050	139091.....	421	143162.....	405	145200.....	369
133489.....	050	139092.....	421	143169.....	405	145202.....	369
133490.....	050	139100.....	421	143170.....	402	145300.....	369
133491.....	050	139101.....	421	143171.....	402	145302.....	369
133493.....	050	139102.....	421	143172.....	402	145510.....	370
133499.....	050	139110.....	423	143190.....	386	145514.....	370
133840.....	100	139111.....	423	143191.....	386	145520.....	370
133841.....	100	139112.....	423	143194.....	386	145524.....	370
133850.....	100	139120.....	425	143221.....	402	145530.....	370
133851.....	100	139121.....	425	143230.....	402	145534.....	370
133881.....	061	139122.....	425	143231.....	402	145551.....	373
133886.....	061	139130.....	422	143241.....	402	145560.....	370
133887.....	061	139131.....	422	143251.....	402	145564.....	370
133891.....	061	139132.....	422	143261.....	402	145580.....	371
133896.....	061			143271.....	402	145581.....	371
133897.....	061	140000		143281.....	402	145584.....	371
		140200.....	378	143291.....	402	145590.....	371
134000		140201.....	378	143350.....	395	145594.....	371
134001.....	075	140210.....	378	143351.....	395	145600.....	371
134011.....	075	140211.....	378	143354.....	395	145604.....	371

145630.....	370	147559.....	283	151511.....	267	152420.....	346
145634.....	370	147566.....	162	151514.....	267	152421.....	346
145640.....	370	147821.....	171	151531.....	267, 284	152430.....	346
145644.....	370	147823.....	171	151534.....	267, 284	152431.....	346
145660.....	370	147826.....	171	151553.....	212	152600.....	359
145664.....	370	147841.....	171	151561.....	185	152601.....	359
145670.....	370	147843.....	171	151564.....	185	152610.....	358
145674.....	370	147846.....	171	151591.....	145	152611.....	358
145680.....	371			151600.....	173	152614.....	358
145684.....	371	148000		151601.....	173	152620.....	355
145690.....	371	148001.....	240	151610.....	173	152621.....	355
145694.....	371	148002.....	240	151611.....	173	152640.....	343
145700.....	371	148004.....	272	151710.....	172	152641.....	343
145710.....	371	148005.....	240	151711.....	172	152644.....	343
145714.....	371	148010.....	159	151740.....	172	152660.....	354
145720.....	371	148012.....	180	151741.....	172	152661.....	354
145724.....	371	148013.....	180	151781.....	164	152680.....	355
145730.....	371	148015.....	159	151786.....	164	152681.....	355
145734.....	371	148016.....	174	151791.....	164	152750.....	353
145830.....	371	148018.....	155	151796.....	164	152751.....	353
145834.....	371	148019.....	137	151800.....	177	152754.....	353
145990.....	040	148040.....	049	151801.....	177	152760.....	353
145994.....	040	148042.....	070	151803.....	177	152761.....	353
		148051.....	272	151804.....	177	152764.....	353
146000		148052.....	273	151810.....	265	152780.....	353
146000.....	026	148053.....	273	151811.....	265	152781.....	353
146001.....	026	148060.....	175	151813.....	265	152784.....	353
146010.....	026	148061.....	180	151814.....	265	152790.....	353
146011.....	026	148062.....	170	151820.....	290	152791.....	353
146111.....	015	148070.....	453	151821.....	290	152794.....	353
146242.....	446	148071.....	453	151830.....	290	152800.....	355
146252.....	446	148091.....	137	151831.....	290	152801.....	355
146260.....	446	148540.....	203	151840.....	177	152810.....	355
146332.....	225			151850.....	070	152811.....	355
146452.....	224	149000		151851.....	070	152960.....	346
146472.....	228	149060.....	291	151853.....	070	152961.....	346
146479.....	861	149061.....	291	151854.....	070	152980.....	349
146482.....	224	149070.....	291	151950.....	441	152981.....	349
146512.....	209	149071.....	291	151951.....	441		
146680.....	208	149380.....	077	151952.....	441	153000	
146682.....	208	149381.....	071	151960.....	441	153102.....	344
146692.....	207	149385.....	071	151961.....	441	153112.....	363
146700.....	206	149387.....	071	151962.....	441	153130.....	363
146701.....	206	149388.....	071			153131.....	363
146704.....	206	149431.....	142	152000		153140.....	363
146800.....	219	149452.....	196	152010.....	289	153141.....	363
146801.....	219	149471.....	163	152011.....	289	153420.....	360
146804.....	219	149472.....	163	152013.....	289	153421.....	360
146942.....	260	149511.....	163	152020.....	289	153424.....	360
		149512.....	163	152021.....	289	153560.....	350
147000		149752.....	211	152023.....	289	153561.....	350
147301.....	304	149762.....	211	152101.....	266	153564.....	350
147306.....	304	149772.....	211	152200.....	342	153580.....	358
147311.....	304	149782.....	210	152201.....	342	153581.....	358
147316.....	304			152204.....	342	153584.....	358
147321.....	304	151000		152230.....	351	153600.....	359
147326.....	304	151040.....	050	152231.....	351	153810.....	361
147360.....	303	151041.....	050	152232.....	351	153811.....	361
147361.....	303	151049.....	050	152240.....	351	153814.....	361
147370.....	303	151271.....	167	152241.....	351	153850.....	360
147371.....	303	151275.....	167	152242.....	351	153851.....	360
147380.....	303	151282.....	214	152320.....	343	153854.....	360
147381.....	303	151311.....	166	152321.....	343		
147411.....	295	151315.....	166	152324.....	343	155000	
147412.....	295	151320.....	156	152330.....	286	155100.....	200
147414.....	295	151321.....	156	152331.....	286	155101.....	200
147441.....	301	151325.....	156	152340.....	205	155104.....	200
147442.....	301	151410.....	168	152341.....	205	155114.....	200
147443.....	301	151411.....	168	152360.....	073	155152.....	314
147444.....	301	151416.....	168	152361.....	073	155156.....	314
147529.....	145	151450.....	168	152370.....	073	155180.....	317
147550.....	283	151451.....	168	152371.....	073	155185.....	317
147551.....	283	151456.....	168	152380.....	447	155206.....	169
				152381.....	447	155216.....	169

155221.....	162	156510.....	292	165400.....	080	175164.....	367
155228.....	162	156511.....	292	165410.....	080	175180.....	367
155236.....	316	156530.....	447			175184.....	367
155290.....	085	156531.....	447	170000		175190.....	341, 367
155300.....	084			170401.....	229	175194.....	367
155340.....	149	157000		170402.....	229	175200.....	367
155372.....	237	157671.....	116			175204.....	367
155373.....	237	157701.....	080	172000		175210.....	367
155380.....	084	157901.....	030	172010.....	380	175214.....	367
155462.....	082	157905.....	030	172011.....	380		
155463.....	082			172020.....	380	176000	
155471.....	066	158000		172021.....	380	176080.....	356
155475.....	066	158400.....	072	172030.....	380	176081.....	356
155479.....	066	158401.....	072	172031.....	380	176090.....	356
155490.....	020	158410.....	072	172040.....	381	176091.....	356
155492.....	020	158411.....	072	172041.....	381		
155500.....	062	158663.....	522	172050.....	381	181000	
155510.....	062	158664.....	522	172051.....	381	181530.....	429
155511.....	062	158723.....	107	172060.....	381	181531.....	429
155520.....	062	158724.....	107	172061.....	381	181532.....	429
155530.....	062	158733.....	107	172070.....	381		
155531.....	062	158734.....	107	172071.....	381	184000	
155540.....	020	158853.....	106	172080.....	381	184000.....	415
155550.....	234	158854.....	106	172081.....	381	184002.....	415
155551.....	234	158941.....	258	172090.....	381	184004.....	415
155552.....	234	158951.....	258	172091.....	381	184010.....	415
155570.....	047	158961.....	258	172100.....	381	184012.....	415
155582.....	019, 021, 047, 235	158969.....	258	172101.....	381	184020.....	415
155583.....	019, 021, 047, 235	158971.....	258	172110.....	381	184022.....	415
155592.....	019, 021, 047, 235			172111.....	381	184030.....	415
155643.....	149	159000		172120.....	381	184032.....	415
155650.....	082	159140.....	117	172121.....	381	184040.....	415
155651.....	024	159141.....	117	172134.....	381	184042.....	415
155652.....	024	159144.....	117	172145.....	381	184060.....	415
155670.....	194	159210.....	118	172190.....	381	184062.....	415
155673.....	194	159211.....	118	172191.....	381	184071.....	412
155714.....	076	159214.....	118	172200.....	381	184140.....	415
155752.....	143	159220.....	118	172201.....	381	184142.....	415
155780.....	018	159221.....	118	172220.....	381	184170.....	415
155785.....	018	159224.....	118	172221.....	381	184172.....	415
155790.....	018	159230.....	118			184290.....	415
155795.....	018	159231.....	118	175000		184292.....	415
155861.....	147	159234.....	118	175010.....	365	184300.....	415
155870.....	083			175014.....	365	184302.....	415
155871.....	083	160000		175020.....	365	184330.....	415
155900.....	065	160900.....	108	175024.....	365	184332.....	415
155901.....	065	160901.....	108	175030.....	365	184440.....	411
155910.....	065	160904.....	108	175034.....	365	184450.....	411
155911.....	065			175040.....	367	184452.....	411
155920.....	065	161000		175044.....	367	184530.....	414
155921.....	065	161271.....	457	175050.....	367	184534.....	414
155930.....	065	161281.....	457	175054.....	367	184560.....	410
155931.....	065	161291.....	457	175060.....	341, 367	184580.....	413
155960.....	055	161301.....	457	175064.....	367	184590.....	414
155970.....	055	161461.....	241	175070.....	367	184620.....	412
		161464.....	241	175074.....	367	184624.....	412
156000				175080.....	367	184630.....	412
156020.....	191	163000		175084.....	367	184634.....	412
156021.....	191	163020.....	318	175090.....	367	184690.....	413
156050.....	237	163021.....	319	175094.....	367		
156051.....	237	163030.....	319	175100.....	367	185000	
156100.....	022	163031.....	319	175104.....	367	185002.....	415
156111.....	019, 021, 022, 047, 235			175110.....	367	185012.....	415
156113.....	019, 021, 022, 047, 235	165000		175114.....	367	185020.....	415
156122.....	019, 021, 022, 047, 235	165100.....	129	175120.....	367	185032.....	415
156141.....	018, 020, 046	165160.....	129	175124.....	367	185042.....	415
156143.....	018, 020, 046	165221.....	129	175130.....	367	185062.....	415
156152.....	018, 020, 046	165222.....	129	175134.....	367	185142.....	415
156268.....	053	165350.....	128	175140.....	367	185172.....	415
156420.....	288	165356.....	128	175144.....	367	185294.....	415
156421.....	288	165358.....	128	175150.....	367	185302.....	415
156500.....	292	165359.....	128	175154.....	367	185440.....	411
156501.....	292	165390.....	080	175160.....	341, 367	185450.....	411

185580.....	413	213630.....	770	228120.....	619	229421.....	560
185582.....	413	213631.....	770	228130.....	551	229422.....	546
185590.....	414	213634.....	770	228210.....	721	229423.....	544
185592.....	414	213642.....	771	228214.....	721	229430.....	544
185622.....	412	213643.....	771	228240.....	721	229431.....	544
185632.....	412	213650.....	771	228332.....	717	229432.....	544
185692.....	413	213651.....	771	228342.....	717	229481.....	609
		213654.....	771	228370.....	730	229482.....	609
186000		213821.....	769	228411.....	722	229521.....	650
186015.....	433	213822.....	767, 769	228412.....	722	229524.....	650
186020.....	433	213862.....	767	228430.....	729	229525.....	650
186042.....	432	213874.....	767	228434.....	729	229531.....	665
186272.....	432	213911.....	768	228505.....	675	229532.....	665
186300.....	429	213914.....	768	228511.....	628	229535.....	665
186301.....	429	213931.....	769	228515.....	628	229551.....	678
186302.....	429	213934.....	769	228521.....	656	229554.....	678
186310.....	429	213939.....	769	228525.....	656	229555.....	678
186311.....	429	213950.....	764	228545.....	577	229561.....	650
186312.....	429	213951.....	764	228555.....	599	229564.....	650
186330.....	429	213954.....	764	228560.....	599	229565.....	650
186331.....	429	213962.....	765	228712.....	548	229571.....	665
186332.....	429	213970.....	765	228722.....	548	229574.....	665
186340.....	429	213971.....	765	228725.....	864	229575.....	665
186341.....	429	213974.....	765	228726.....	864	229581.....	678
186342.....	429			228730.....	864	229584.....	678
186350.....	429	214000		228752.....	557	229585.....	678
186351.....	429	214100.....	762	228753.....	547	229664.....	669
186352.....	429	214101.....	762	228754.....	558	229665.....	669
186360.....	429	214102.....	762	228771.....	654	229694.....	668
186361.....	429	214350.....	760	228775.....	654	229695.....	668
186362.....	429	214351.....	760	228776.....	654	229702.....	698
186640.....	429			228922.....	548	229740.....	589
186641.....	429	220000		228925.....	548	229741.....	597
186642.....	429	220000.....	861	228935.....	549	229931.....	684
186762.....	433			228945.....	549	229935.....	684
186772.....	433	227000		228960.....	540	229941.....	684
186952.....	433	227000.....	864	228961.....	540	229945.....	684
		227090.....	721	228965.....	540	229951.....	684
188000		227092.....	721			229955.....	684
188500.....	431	227140.....	846	229000		229961.....	680
188510.....	431	227160.....	846	229020.....	545	229965.....	680
188520.....	431	227174.....	622	229021.....	545	229971.....	680
188530.....	430	227176.....	622	229022.....	545	229975.....	680
188550.....	430	227185.....	633	229050.....	554		
		227194.....	635	229054.....	554	230000	
210000		227195.....	635	229057.....	554	230030.....	643
210060.....	859	227198.....	635	229059.....	554	230034.....	643
210061.....	859	227219.....	538	229062.....	698	230044.....	627
210064.....	859	227220.....	538	229071.....	682	230045.....	627
		227221.....	538	229072.....	682	230060.....	550
213000		227410.....	588	229075.....	682	230061.....	554
213440.....	776	227418.....	588	229081.....	682	230063.....	554
213441.....	776	227461.....	716	229084.....	682	230066.....	554
213444.....	776	227462.....	716	229085.....	682	230069.....	554
213450.....	777	227504.....	590	229090.....	595	230084.....	627
213451.....	777	227505.....	590	229100.....	597	230085.....	627
213454.....	777	227507.....	590	229110.....	701	230090.....	573
213459.....	777	227508.....	590	229162.....	552	230100.....	734
213470.....	772	227550.....	537	229172.....	552	230110.....	734
213471.....	772	227600.....	719	229182.....	619	230170.....	719
213474.....	772	227604.....	719	229200.....	730	230174.....	719
213480.....	773	227680.....	718	229230.....	730	230355.....	629
213481.....	773	227684.....	718	229234.....	730	230365.....	654
213484.....	773	227700.....	670	229260.....	864	230435.....	543
213488.....	771, 773	227701.....	670	229262.....	865	230444.....	623
213489.....	773	227734.....	608	229269.....	864	230445.....	623
213511.....	774	227744.....	608	229320.....	729	230465.....	547
213514.....	774	227922.....	551	229324.....	729	230655.....	626
213521.....	775			229374.....	729	230657.....	626
213524.....	775	228000		229381.....	733		
213529.....	775	228050.....	533	229383.....	733	231000	
213620.....	770	228051.....	533	229410.....	571	231010.....	184, 633
213621.....	770	228100.....	551	229411.....	571	231012.....	184, 633
213624.....	770	228110.....	551	229420.....	560	231015.....	184, 633

231035.....	589	232165.....	566	233312.....	655	240004.....	743
231045.....	689	232175.....	567	233407.....	545	240006.....	742
231055.....	689	232185.....	567	233417.....	545	240007.....	740
231072.....	605	232195.....	566	233427.....	560	240008.....	741
231092.....	605	232285.....	645	233437.....	560	240009.....	743
231205.....	620	232294.....	575	233447.....	571	240010.....	743
231215.....	557	232295.....	575	233457.....	571	240020.....	740
231225.....	557	232405.....	637	233500.....	725	240021.....	741
231230.....	557	232415.....	637	233520.....	725	240022.....	743
231231.....	575	232431.....	183, 646	233530.....	725	240024.....	742
231233.....	562	232435.....	183, 646	233540.....	723		
231234.....	548	232441.....	158, 658	233550.....	723	410000	
231235.....	570	232445.....	158, 658	233570.....	598	410861.....	865
231245.....	533	232451.....	659	233571.....	598	410865.....	865
231305.....	575	232455.....	659	233580.....	598		
231315.....	642	232461.....	183, 646	233582.....	598	451000	
231351.....	641	232465.....	183, 646	233601.....	699	451105.....	846
231355.....	641	232471.....	158, 658	233605.....	699	451301.....	846
231360.....	541	232475.....	158, 658	233611.....	699		
231361.....	673	232481.....	662	233615.....	699	461000	
231370.....	570	232485.....	662	233621.....	699	461050.....	848
231371.....	570	232491.....	661	233625.....	699	461060.....	848
231410.....	561	232495.....	661	233635.....	700	461157.....	848
231411.....	561	232497.....	661	233639.....	700	461217.....	848
231420.....	562	232531.....	663	233650.....	701		
231440.....	570	232535.....	663	233660.....	701	464000	
231455.....	563	232537.....	663	233672.....	727	464030.....	857
231457.....	563	232800.....	600	233676.....	727	464031.....	856
231465.....	618	232810.....	600	233692.....	726	464032.....	855
231475.....	555	232820.....	601	233696.....	726	464091.....	856
231505.....	582	232830.....	601	233712.....	727	464107.....	856
231515.....	690	232840.....	603	233716.....	727	464108.....	856
231525.....	591	232850.....	603	233732.....	727	464109.....	856
231535.....	591	232860.....	603	233736.....	727	464140.....	852
231541.....	674	232864.....	603	233790.....	727	464142.....	853
231545.....	674	232870.....	603	233791.....	727	464143.....	441
231585.....	618	232874.....	603	233792.....	720	464144.....	852
231595.....	555	232880.....	603	233795.....	727	464168.....	857
231602.....	551	232884.....	603	233796.....	727	464170.....	857
231612.....	551	232890.....	603	233797.....	720	464200.....	857
231672.....	593	232894.....	603			464804.....	853
231682.....	593	232905.....	640	234000			
231745.....	644	232915.....	640	234205.....	607	470000	
231765.....	576			234215.....	607	470500.....	850
231805.....	616	233000		234225.....	607	470502.....	850
231807.....	616	233094.....	690	234235.....	607	470505.....	849
231815.....	563	233095.....	690	234245.....	607	470506.....	850
231817.....	563	233104.....	690	234255.....	607	470507.....	850
231835.....	572	233105.....	690	234340.....	600	470540.....	851
231845.....	572	233114.....	653	234344.....	604	470541.....	850
231849.....	572	233115.....	653	234350.....	600	470542.....	850
231855.....	564	233124.....	671	234354.....	604	470544.....	850
231865.....	636	233125.....	671	234401.....	028, 550	470545.....	850
231954.....	609	233134.....	671	234411.....	028, 550	470546.....	850
231955.....	609	233135.....	671	234421.....	028, 550	470547.....	851
231960.....	609	233144.....	583	234430.....	028	470548.....	851
231961.....	609	233145.....	583	234431.....	028	470549.....	851
		233164.....	583	234441.....	028	470550.....	849
232000		233165.....	583	234501.....	666	470670.....	829
232045.....	614	233184.....	583	234504.....	666	470671.....	829
232055.....	672	233185.....	583	234505.....	666	470672.....	829
232065.....	532	233211.....	628	234511.....	666	470674.....	830, 833
232075.....	547	233214.....	653	234514.....	666	470675.....	830, 833
232085.....	547	233215.....	628	234515.....	666	470677.....	829
232095.....	541	233225.....	629	234521.....	651	470680.....	833
232101.....	664	233231.....	653	234524.....	651	470681.....	807, 833
232104.....	664	233235.....	653	234525.....	651	470682.....	807, 833
232105.....	664	233241.....	691	234531.....	678	470683.....	807, 833
232115.....	558	233245.....	691	234534.....	678	470800.....	838
232119.....	558	233251.....	691	234535.....	678	470803.....	840
232125.....	558	233255.....	691			470804.....	840
232135.....	568	233275.....	583	240000		470806.....	840
232145.....	568	233285.....	583	240000.....	740	470807.....	840
232155.....	566	233302.....	655	240002.....	741	470808.....	839

470812.....	838	552693.....	795	560622.....	875	1000134.....	307
470821.....	839	552694.....	795	560624.....	875	1000135.....	307
470822.....	839	552702.....	793	560662.....	875	1000136.....	307
470823.....	839	552703.....	793	560702.....	873	1000137.....	307
470824.....	839	552704.....	793	560704.....	873	1000138.....	307
		552712.....	793	560712.....	874		
508000		552713.....	793	560714.....	874	1000300	
508211.....	240	552714.....	793	560722.....	874	1000324.....	203
		552722.....	793	560724.....	874	1000325.....	203
548000		552723.....	793	560732.....	874	1000326.....	203
548014.....	734	552724.....	793	560734.....	874	1000327.....	161
548021.....	734	552727.....	793	560741.....	879	1000328.....	161
548028.....	169	552732.....	783	560752.....	018	1000329.....	161
		552733.....	783	560762.....	547	1000330.....	161
550000		552734.....	783			1000331.....	665
550073.....	881	552742.....	783	570000		1000332.....	266, 676
550074.....	881	552743.....	783	570532.....	118	1000333.....	178, 630
550082.....	881	552744.....	783	570672.....	010	1000334.....	178, 656
550092.....	881	552752.....	783			1000335.....	657
550412.....	797, 805	552753.....	783	631000		1000336.....	620
550413.....	798, 799, 803	552754.....	783	631300.....	815	1000337.....	677
550415.....	797, 805	552762.....	783	631301.....	815	1000338.....	676
550416.....	798, 799, 803	552763.....	783	631302.....	815	1000339.....	676
550560.....	797, 798, 799, 803, 805	552764.....	783	631303.....	815	1000340.....	183, 652
550570.....	798, 799	552772.....	782	631304.....	815	1000341.....	183, 652
550571.....	797	552773.....	782	631305.....	815	1000342.....	183, 652
		552774.....	782	631313.....	815	1000343.....	559
551000		552782.....	782	631315.....	815	1000344.....	559
551242.....	869	552783.....	782	631317.....	815	1000345.....	559
551243.....	869	552784.....	782	631323.....	815	1000346.....	559
551252.....	871	552792.....	783	631325.....	815	1000384.....	720
551253.....	871	552793.....	783	631327.....	815	1000386.....	517
551372.....	881	552794.....	783	631337.....	327	1000387.....	517
551402.....	874	552802.....	787	631339.....	327	1000388.....	517
551412.....	874	552803.....	787	631347.....	327	1000389.....	517
551532.....	876	552804.....	787	631349.....	327	1000390.....	517
551602.....	875	552812.....	787	631501.....	813	1000391.....	517
551612.....	875	552813.....	787	631502.....	813	1000398.....	532
551862.....	432	552814.....	787	631505.....	813		
551882.....	873	552822.....	787	631510.....	813	1000400	
551893.....	228	552823.....	787	631512.....	813	1000400.....	537
551902.....	871	552824.....	787	631520.....	813	1000412.....	119
551912.....	873	552832.....	787	631521.....	813	1000413.....	119
551933.....	282	552833.....	787	631522.....	813	1000414.....	184
551944.....	127	552834.....	787	631523.....	813	1000415.....	184
		552852.....	787			1000416.....	559
552000		552853.....	787	900000		1000417.....	559
552120.....	799	552854.....	787	900011.....	597	1000418.....	559
552121.....	799	552863.....	807, 834			1000422.....	186
552122.....	799	552883.....	807, 834	955000		1000423.....	186
552273.....	812			955135.....	860	1000424.....	287
552422.....	797	560000				1000425.....	287
552423.....	797	560122.....	870	961000		1000426.....	287
552425.....	797	560142.....	653	961034.....	859	1000427.....	287
552442.....	798	560143.....	267	961037.....	859	1000433.....	059
552443.....	798	560161.....	020	961250.....	859	1000434.....	058
552445.....	798	560222.....	875	961270.....	859	1000435.....	058
552453.....	810, 830	560231.....	874	961271.....	859	1000436.....	058
552460.....	810	560232.....	874	961276.....	859	1000437.....	238
552461.....	810	560233.....	874	961370.....	859	1000438.....	059
552462.....	810	560234.....	874	961371.....	859	1000439.....	058
552463.....	810	560302.....	868	961376.....	859	1000440.....	058
552482.....	803	560332.....	868			1000441.....	058
552483.....	803	560352.....	868	977000		1000442.....	238
552485.....	803	560362.....	077	977399.....	773	1000443.....	238
552522.....	805	560372.....	875			1000445.....	238
552523.....	805	560402.....	876	1000100		1000446.....	657
552525.....	805	560422.....	876	1000127.....	306	1000447.....	675
552649.....	809	560432.....	018	1000128.....	306	1000448.....	631
552650.....	809	560463.....	881	1000129.....	306	1000449.....	551
552651.....	809	560473.....	881	1000130.....	306	1000457.....	749
552652.....	809	560542.....	870	1000131.....	306	1000458.....	749
552653.....	809	560552.....	870	1000132.....	306	1000459.....	749
552692.....	795	560603.....	070	1000133.....	307	1000460.....	749

1000461.....	749	1000533.....	753	1000654.....	727	1000762.....	556
1000462.....	749	1000534.....	753	1000655.....	720	1000763.....	022
1000463.....	749	1000535.....	757	1000656.....	357	1000764.....	022, 044
1000464.....	749	1000536.....	757	1000657.....	357	1000769.....	359
1000465.....	749	1000537.....	757	1000658.....	357	1000773.....	044
1000466.....	750	1000538.....	755	1000665.....	546	1000777.....	215
1000467.....	750	1000539.....	755	1000666.....	546	1000778.....	215
1000468.....	750	1000540.....	755	1000668.....	221	1000780.....	215
1000469.....	750	1000541.....	755	1000669.....	221	1000781.....	215
1000470.....	750	1000542.....	755	1000670.....	221	1000782.....	048
1000471.....	750	1000543.....	755	1000675.....	177	1000783.....	256
1000472.....	751	1000544.....	755	1000676.....	177	1000784.....	256
1000473.....	751	1000545.....	755	1000677.....	354	1000785.....	256
1000474.....	751	1000546.....	755	1000678.....	354	1000786.....	256
1000475.....	751	1000547.....	755	1000679.....	355	1000791.....	515
1000476.....	751	1000548.....	755	1000680.....	355	1000792.....	515
1000477.....	751	1000549.....	755	1000681.....	617	1000793.....	515
1000478.....	751	1000550.....	755	1000682.....	549	1000794.....	515
1000479.....	751	1000551.....	755	1000683.....	549	1000795.....	513
1000480.....	751	1000552.....	755	1000684.....	873	1000796.....	513
1000481.....	751	1000553.....	755	1000685.....	259	1000797.....	634
1000482.....	751	1000554.....	755	1000686.....	259	1000799.....	565
1000483.....	751	1000555.....	755	1000687.....	259		
1000484.....	751	1000556.....	756	1000688.....	259	1000800	
1000485.....	751	1000557.....	756	1000689.....	259	1000801.....	565
1000486.....	751	1000558.....	756	1000690.....	259	1000807.....	265
1000487.....	750	1000559.....	756	1000691.....	259	1000808.....	265
1000488.....	750	1000560.....	756	1000692.....	259	1000809.....	074
1000489.....	750	1000561.....	756	1000693.....	259	1000810.....	074, 265
1000490.....	754	1000562.....	756	1000694.....	259	1000811.....	074, 265
1000491.....	754	1000563.....	756	1000695.....	259	1000812.....	074, 265
1000492.....	754	1000564.....	756	1000696.....	259	1000813.....	074
1000493.....	754	1000565.....	756			1000814.....	074
1000494.....	754	1000566.....	756	1000700		1000816.....	216
1000495.....	754	1000567.....	756	1000700.....	865	1000818.....	216
1000496.....	754	1000568.....	756	1000701.....	865	1000820.....	614
1000497.....	754	1000569.....	756	1000702.....	304	1000821.....	532
1000498.....	754	1000570.....	756	1000703.....	304	1000822.....	550
1000499.....	753	1000571.....	755	1000704.....	304	1000823.....	672
		1000574.....	443	1000707.....	344	1000824.....	151
1000500		1000575.....	443	1000708.....	344	1000825.....	153, 199
1000500.....	753	1000576.....	444	1000709.....	363	1000826.....	835
1000501.....	753	1000577.....	444	1000710.....	363	1000827.....	130
1000502.....	753	1000579.....	019, 021, 047, 235	1000711.....	397	1000828.....	130
1000503.....	753	1000580.....	019, 021, 047, 235	1000712.....	397	1000833.....	705
1000504.....	753	1000581.....	036	1000713.....	399	1000834.....	620
1000505.....	753	1000587.....	668	1000714.....	454	1000835.....	677
1000506.....	753	1000588.....	668	1000715.....	454	1000855.....	092, 248
1000507.....	753			1000716.....	454	1000856.....	092, 248
1000508.....	753	1000600		1000717.....	454	1000857.....	092, 248
1000509.....	753	1000613.....	150	1000718.....	455	1000864.....	092, 248
1000510.....	753	1000614.....	152	1000719.....	455	1000865.....	092, 248
1000511.....	753	1000615.....	198	1000720.....	455	1000866.....	092, 248
1000512.....	753	1000616.....	151	1000721.....	455	1000868.....	862
1000513.....	753	1000618.....	151	1000722.....	010	1000869.....	862
1000514.....	753	1000619.....	151	1000723.....	010	1000870.....	862
1000515.....	753	1000621.....	153, 199	1000724.....	010	1000871.....	862
1000516.....	753	1000623.....	153, 199	1000725.....	098, 254	1000872.....	862
1000517.....	753	1000624.....	153, 199	1000726.....	098, 254	1000873.....	862
1000518.....	753	1000626.....	153, 199	1000727.....	098, 254	1000874.....	863
1000519.....	753	1000628.....	153, 199	1000729.....	204	1000875.....	863
1000520.....	753	1000629.....	153, 199	1000730.....	204	1000876.....	863
1000521.....	753	1000631.....	266	1000731.....	204	1000877.....	863
1000522.....	753	1000634.....	167	1000732.....	204	1000878.....	863
1000523.....	753	1000635.....	167	1000733.....	227	1000879.....	863
1000524.....	753	1000636.....	167	1000734.....	227	1000880.....	670
1000525.....	753	1000637.....	167	1000735.....	599	1000881.....	670
1000526.....	753	1000638.....	156	1000736.....	580	1000882.....	670
1000527.....	753	1000639.....	156	1000743.....	139	1000886.....	299
1000528.....	753	1000640.....	156	1000745.....	139	1000887.....	299
1000529.....	753	1000650.....	171	1000746.....	139	1000888.....	299
1000530.....	753	1000651.....	171	1000748.....	139	1000889.....	299
1000531.....	753	1000652.....	171	1000760.....	556	1000890.....	299
1000532.....	753	1000653.....	726	1000761.....	556	1000891.....	299

1000892.....	299	1001019.....	329	1001297.....	116	1001424.....	268
1000893.....	299	1001020.....	329	1001299.....	220	1001425.....	268
1000894.....	299	1001028.....	873			1001426.....	268
1000895.....	299	1001029.....	873	1001300		1001427.....	352
1000896.....	299	1001030.....	871	1001300.....	220	1001428.....	352
1000897.....	299	1001031.....	877	1001301.....	220	1001429.....	352
		1001032.....	877	1001303.....	220	1001430.....	352
1000900		1001033.....	877	1001304.....	220	1001431.....	268
1000906.....	452	1001035.....	880	1001305.....	220	1001432.....	268
1000907.....	452	1001038.....	880	1001306.....	113	1001433.....	268
1000908.....	452			1001307.....	113	1001434.....	268
1000909.....	860	1001100		1001308.....	113	1001435.....	293
1000910.....	155	1001114.....	853	1001309.....	113	1001436.....	293
1000911.....	155	1001115.....	853	1001310.....	113	1001447.....	107
1000914.....	474	1001132.....	517	1001312.....	113	1001448.....	107
1000915.....	474	1001133.....	517	1001314.....	687	1001449.....	192
1000916.....	474	1001136.....	517	1001315.....	687	1001450.....	192
1000917.....	474	1001153.....	838	1001316.....	687	1001451.....	192
1000918.....	130	1001155.....	448	1001317.....	687	1001452.....	192
1000926.....	114	1001156.....	448	1001343.....	104	1001453.....	192
1000927.....	114	1001157.....	460, 706	1001344.....	104	1001454.....	192
1000928.....	114	1001161.....	460, 706	1001345.....	104	1001460.....	025
1000929.....	114	1001165.....	461, 707	1001346.....	104	1001461.....	025
1000930.....	114	1001166.....	461, 707	1001347.....	104	1001462.....	025
1000931.....	114	1001167.....	461, 707	1001348.....	104	1001463.....	025
1000932.....	114	1001168.....	461, 707	1001350.....	058	1001464.....	227
1000933.....	114	1001169.....	461, 707	1001351.....	058	1001465.....	227
1000934.....	114	1001170.....	461, 707	1001352.....	378	1001466.....	345
1000935.....	114	1001171.....	461, 707	1001354.....	378	1001467.....	345
1000936.....	114	1001172.....	461, 707	1001355.....	378	1001468.....	189
1000937.....	114			1001357.....	880	1001469.....	189
1000939.....	873	1001200		1001359.....	714	1001470.....	345
1000940.....	873	1001217.....	026	1001367.....	361	1001471.....	345
1000941.....	873	1001220.....	048	1001368.....	361	1001472.....	189
1000942.....	873	1001221.....	049	1001369.....	361	1001473.....	189
1000957.....	047	1001242.....	872	1001375.....	365	1001474.....	345
1000974.....	398	1001243.....	872	1001376.....	365	1001475.....	345
1000975.....	398	1001244.....	872	1001377.....	365	1001476.....	361
1000976.....	398	1001245.....	872	1001378.....	367	1001477.....	361
1000977.....	398	1001249.....	857	1001379.....	367	1001478.....	361
1000978.....	398	1001250.....	523	1001380.....	341, 367	1001479.....	361
1000979.....	398	1001251.....	523	1001381.....	367	1001480.....	361
1000980.....	356	1001252.....	715	1001382.....	367	1001481.....	361
1000981.....	356	1001253.....	715	1001383.....	367	1001482.....	361
1000982.....	356	1001254.....	715	1001384.....	367	1001483.....	361
1000983.....	356	1001255.....	715	1001385.....	367	1001484.....	361
1000984.....	356	1001256.....	715	1001386.....	367	1001485.....	392
1000985.....	356	1001262.....	715	1001387.....	367	1001486.....	392
1000986.....	356	1001263.....	715	1001388.....	367	1001487.....	392
1000987.....	356	1001264.....	464	1001389.....	367	1001488.....	553
1000988.....	356	1001265.....	059	1001390.....	341, 367	1001489.....	553
1000989.....	356	1001266.....	058	1001392.....	367	1001490.....	553
1000990.....	356	1001267.....	853	1001393.....	341, 367	1001491.....	553
1000991.....	356	1001269.....	348	1001394.....	367	1001492.....	553
1000992.....	356	1001270.....	348	1001395.....	367	1001493.....	553
1000993.....	356	1001271.....	174			1001494.....	553
1000994.....	356	1001272.....	148	1001400		1001495.....	286
1000995.....	356	1001273.....	148	1001400.....	112	1001496.....	286
1000996.....	356	1001274.....	148	1001401.....	112		
1000997.....	356	1001275.....	148	1001402.....	112	1001500	
1000998.....	356	1001276.....	148	1001403.....	112	1001502.....	012
1000999.....	356	1001283.....	328	1001404.....	112	1001503.....	210
		1001284.....	328	1001405.....	112	1001505.....	257
1001000		1001285.....	328	1001406.....	112	1001506.....	257
1001000.....	356	1001286.....	328	1001407.....	112	1001508.....	257
1001001.....	356	1001287.....	328	1001408.....	112	1001509.....	257
1001002.....	356	1001288.....	328	1001409.....	112	1001510.....	369
1001003.....	356	1001289.....	349	1001410.....	112	1001511.....	369
1001009.....	227	1001290.....	349	1001411.....	112	1001512.....	369
1001010.....	227	1001292.....	349	1001419.....	352	1001513.....	370
1001015.....	463, 711, 745	1001293.....	329	1001420.....	352	1001514.....	370
1001016.....	463, 711, 745	1001294.....	329	1001421.....	352	1001515.....	370
1001017.....	463, 711, 745	1001295.....	116	1001422.....	352	1001516.....	370
1001018.....	463, 711, 745	1001296.....	116	1001423.....	268	1001517.....	370

1001518.....	370	1001807.....	760	1001895.....	096, 252	1001995.....	482
1001519.....	370	1001808.....	760	1001896.....	096, 252	1001996.....	482
1001520.....	370	1001809.....	760	1001897.....	096, 252	1001997.....	552
1001521.....	371	1001810.....	761	1001898.....	096, 252	1001998.....	552
1001522.....	371	1001813.....	760	1001899.....	096, 252	1001999.....	548
1001523.....	371	1001814.....	759				
1001524.....	371	1001815.....	760	1001900		1002000	
1001525.....	371	1001816.....	759	1001900.....	096, 252	1002000.....	548
1001526.....	371	1001817.....	759	1001901.....	518	1002001.....	548
1001527.....	371	1001818.....	040	1001902.....	519	1002002.....	614
1001528.....	371	1001819.....	040	1001903.....	519	1002003.....	271
1001529.....	371	1001820.....	040	1001904.....	519	1002004.....	269
1001530.....	371	1001821.....	040	1001905.....	520	1002005.....	270
1001531.....	373	1001822.....	200	1001906.....	520	1002006.....	270
1001532.....	373	1001823.....	573	1001907.....	520	1002008.....	271
1001533.....	373	1001824.....	573	1001908.....	521	1002010.....	269
1001534.....	373	1001825.....	477	1001909.....	681	1002011.....	269
1001536.....	373	1001826.....	477	1001910.....	681	1002012.....	269
1001537.....	373	1001827.....	477	1001911.....	681	1002013.....	269
1001538.....	373	1001828.....	476	1001912.....	681	1002015.....	269
1001539.....	373	1001829.....	476	1001913.....	681	1002016.....	629
1001542.....	040	1001830.....	476	1001914.....	681	1002017.....	629
1001560.....	870	1001831.....	476	1001916.....	876	1002018.....	654
1001561.....	870	1001832.....	476	1001917.....	876	1002020.....	311
1001562.....	870	1001833.....	476	1001918.....	870	1002021.....	311
1001563.....	870	1001834.....	476	1001919.....	870	1002022.....	311
1001564.....	870	1001835.....	476	1001920.....	872	1002023.....	304
1001565.....	870	1001836.....	476	1001921.....	872	1002024.....	304
1001566.....	870	1001841.....	477	1001922.....	872	1002025.....	304
1001568.....	873	1001847.....	477	1001923.....	872	1002026.....	800
1001569.....	873	1001848.....	477	1001924.....	474	1002027.....	800
1001570.....	873	1001849.....	477	1001925.....	474	1002028.....	800
1001571.....	874	1001850.....	477	1001926.....	474	1002029.....	303
1001572.....	874	1001851.....	477	1001927.....	474	1002030.....	303
1001573.....	874	1001855.....	683	1001930.....	462, 705	1002032.....	663
1001574.....	869	1001856.....	683	1001931.....	462, 705	1002033.....	663
1001575.....	869	1001857.....	228	1001932.....	462, 705	1002034.....	663
		1001858.....	228	1001933.....	462, 705	1002035.....	661
1001600		1001859.....	823, 848	1001934.....	705	1002036.....	661
1001633.....	604	1001860.....	393	1001937.....	589	1002037.....	661
1001634.....	604	1001861.....	392	1001938.....	589	1002041.....	654
1001635.....	604	1001862.....	396	1001939.....	241	1002045.....	080
1001636.....	604	1001863.....	396	1001940.....	053	1002046.....	080
1001637.....	605	1001864.....	396	1001941.....	053	1002047.....	049
1001638.....	605	1001865.....	346	1001942.....	053	1002048.....	362
1001642.....	606	1001866.....	346	1001943.....	053	1002049.....	362
1001643.....	606	1001867.....	346	1001944.....	053	1002050.....	362
1001644.....	606	1001868.....	387	1001945.....	053	1002051.....	260
1001645.....	606	1001869.....	387	1001950.....	067	1002052.....	260
1001647.....	107	1001870.....	387	1001951.....	067	1002053.....	127
1001648.....	107	1001871.....	351	1001952.....	067	1002054.....	127
1001676.....	010	1001872.....	351	1001962.....	597	1002055.....	127
1001677.....	010	1001873.....	351	1001963.....	597	1002056.....	127
1001678.....	010	1001874.....	388	1001964.....	588	1002057.....	127
1001691.....	130	1001875.....	388	1001965.....	588	1002058.....	127
1001692.....	130	1001876.....	388	1001968.....	400	1002059.....	127
		1001877.....	094, 250, 321	1001969.....	641	1002066.....	223
1001700		1001878.....	095, 251	1001970.....	641	1002067.....	223
1001701.....	062	1001879.....	095, 251	1001971.....	811	1002068.....	012
1001756.....	879	1001880.....	095, 291	1001972.....	800	1002069.....	643
1001778.....	534	1001881.....	094, 250, 321	1001973.....	514	1002070.....	643
1001796.....	761	1001882.....	094, 250, 321	1001974.....	514	1002071.....	643
1001797.....	761	1001883.....	095, 251, 321	1001975.....	514	1002072.....	282
1001798.....	761	1001884.....	095, 251, 321	1001976.....	514	1002073.....	282
1001799.....	761	1001885.....	095, 251, 321	1001978.....	491	1002074.....	282
		1001886.....	095, 251, 321	1001980.....	482	1002075.....	312
1001800		1001887.....	095, 251, 321	1001981.....	482	1002076.....	312
1001800.....	761	1001888.....	095, 251, 321	1001982.....	482	1002077.....	312
1001801.....	761	1001889.....	096, 252	1001989.....	491	1002082.....	823, 853
1001802.....	761	1001890.....	097, 253	1001990.....	491	1002097.....	822
1001803.....	761	1001891.....	097, 253	1001991.....	491	1002098.....	466, 710
1001804.....	761	1001892.....	097, 253	1001992.....	491	1002099.....	466, 710
1001805.....	761	1001893.....	096, 252	1001993.....	491		
1001806.....	760	1001894.....	096, 252	1001994.....	482		

1002100		1002190..... 212	1002594..... 474	1002696..... 424
1002100..... 466, 710		1002191..... 212	1002596..... 474	1002697..... 429
1002101..... 466, 710		1002192..... 212	1002597..... 641	1002698..... 429
1002102..... 466, 710		1002193..... 123	1002598..... 500	1002699..... 429
1002103..... 466, 710		1002194..... 123, 687	1002599..... 500	
1002104..... 479		1002195..... 190		1002700
1002105..... 479		1002196..... 123	1002600	1002700..... 429
1002106..... 479		1002197..... 123	1002600..... 500	1002701..... 429
1002107..... 479		1002198..... 580	1002601..... 500	1002702..... 429
1002108..... 479		1002199..... 580	1002602..... 428	1002703..... 429
1002109..... 479			1002603..... 428	1002704..... 429
1002110..... 390	1002200		1002604..... 428	1002705..... 429
1002111..... 390	1002200..... 581		1002605..... 647	1002785..... 852
1002113..... 390	1002201..... 590		1002606..... 647	1002791..... 852
1002116..... 208	1002202..... 590		1002607..... 207	1002792..... 852
1002117..... 208	1002203..... 590		1002608..... 207	
1002118..... 208	1002204..... 455		1002610..... 386	1002800
1002119..... 208	1002205..... 455		1002611..... 386	1002803..... 852
1002120..... 449	1002206..... 455		1002612..... 386	1002809..... 334
1002122..... 203	1002207..... 455		1002631..... 339	1002810..... 334
1002123..... 878	1002208..... 455		1002632..... 339	1002811..... 334
1002124..... 878	1002209..... 455		1002633..... 339	1002812..... 334
1002125..... 878	1002210..... 455		1002634..... 339	1002813..... 334
1002126..... 878	1002211..... 455		1002637..... 341	1002814..... 334
1002127..... 878	1002213..... 185		1002638..... 341	1002815..... 334
1002128..... 875	1002215..... 267, 284		1002639..... 341	1002816..... 334
1002131..... 155	1002216..... 267		1002640..... 341	1002817..... 334
1002132..... 310, 825	1002217..... 044		1002641..... 341	1002818..... 334
1002133..... 310, 825	1002218..... 849		1002642..... 341	1002819..... 334
1002134..... 310, 825	1002220..... 849		1002643..... 341	1002820..... 334
1002135..... 868	1002221..... 849		1002644..... 341	1002827..... 877
1002136..... 056	1002228..... 213		1002645..... 341	1002828..... 877
1002137..... 057	1002229..... 213		1002646..... 341	1002838..... 120
1002138..... 057	1002232..... 518		1002647..... 341	1002839..... 120
1002139..... 057	1002236..... 761		1002648..... 341	1002842..... 157
1002140..... 205	1002237..... 761		1002649..... 341	1002843..... 157
1002141..... 783	1002238..... 154		1002650..... 341	1002844..... 157
1002142..... 783	1002239..... 169		1002651..... 341	1002845..... 341
1002143..... 787	1002240..... 169		1002652..... 341	1002847..... 031
1002144..... 787	1002264..... 040		1002653..... 341	1002848..... 031
1002145..... 029	1002265..... 040		1002654..... 341	1002849..... 121
1002146..... 029			1002655..... 341	1002850..... 121
1002147..... 146	1002400		1002656..... 341	1002854..... 395
1002148..... 146	1002402..... 624		1002657..... 341	1002855..... 194
1002149..... 146	1002403..... 625		1002658..... 341	1002856..... 194
1002150..... 029	1002404..... 027		1002659..... 341	1002857..... 451
1002151..... 404	1002405..... 027		1002660..... 341	1002858..... 067, 322, 824
1002152..... 404	1002409..... 839		1002661..... 337	1002859..... 197
1002153..... 404	1002411..... 820		1002662..... 337	1002860..... 225
1002154..... 675	1002420..... 518		1002663..... 334	1002867..... 688
1002155..... 644	1002422..... 519		1002664..... 334	1002868..... 632
1002157..... 679	1002423..... 855		1002665..... 334	1002869..... 632
1002158..... 576	1002424..... 855		1002666..... 334	1002870..... 578
1002159..... 038	1002425..... 855		1002667..... 335	1002871..... 578
1002160..... 038	1002430..... 208		1002668..... 335	1002873..... 389
1002161..... 038	1002431..... 208		1002669..... 335	1002874..... 389
1002162..... 038	1002432..... 208		1002670..... 335	1002875..... 389
1002163..... 040	1002494..... 539		1002671..... 335	1002876..... 344
1002164..... 040			1002672..... 335	1002877..... 344
1002165..... 040	1002500		1002673..... 335	1002878..... 344
1002167..... 036	1002503..... 648		1002674..... 335	1002879..... 508
1002168..... 037	1002504..... 649		1002675..... 335	1002880..... 508
1002169..... 072	1002505..... 649		1002676..... 335	1002881..... 509
1002170..... 072	1002558..... 039		1002677..... 335	1002882..... 099, 255
1002171..... 073	1002562..... 039		1002678..... 335	1002884..... 688
1002172..... 073	1002563..... 039		1002686..... 363	1002885..... 508
1002173..... 205	1002564..... 039		1002688..... 425	1002886..... 508
1002174..... 177	1002582..... 011		1002689..... 425	1002887..... 509
1002175..... 286	1002583..... 011		1002690..... 425	1002888..... 508
1002185..... 719	1002584..... 285		1002691..... 847	1002889..... 508
1002186..... 719	1002585..... 285		1002692..... 847	1002890..... 101
1002187..... 725	1002591..... 474		1002693..... 847	1002891..... 101
1002188..... 722	1002592..... 474		1002694..... 424	1002892..... 848
1002189..... 717	1002593..... 474		1002695..... 424	1002893..... 733

1002895.....	733	1002976.....	297	1003054.....	257
1002897.....	733	1002977.....	297	1003055.....	257
1002898.....	733	1002978.....	297	1003057.....	489
1002899.....	733	1002979.....	440	1003058.....	489
1002900		1002980.....	440	1003059.....	489
1002900.....	660	1002981.....	440	1003060.....	489
1002902.....	660	1002982.....	445	1003061.....	489
1002903.....	689	1002983.....	445	1003062.....	489
1002904.....	689	1002984.....	445	1003063.....	489
1002905.....	670	1002985.....	225	1003064.....	489
1002906.....	577	1002986.....	225	1003067.....	490
1002907.....	577	1002987.....	225	1003068.....	490
1002909.....	103	1002989.....	638	1003069.....	490
1002910.....	103	1002990.....	639	1003070.....	490
1002911.....	103	1002991.....	574	1003071.....	524
1002912.....	103	1002992.....	574	1003072.....	524
1002913.....	103	1002993.....	145	1003073.....	525
1002914.....	103	1002994.....	822	1003074.....	524
1002915.....	140	1002995.....	822	1003075.....	525
1002917.....	140	1002996.....	801	1003076.....	527
1002918.....	140	1002997.....	801	1003077.....	527
1002919.....	140	1002998.....	801	1003078.....	527
1002920.....	188	1002999.....	801	1003079.....	527
1002921.....	188	1003000		1003080.....	527
1002922.....	445	1003001.....	579	1003081.....	527
1002925.....	144	1003002.....	079	1003083.....	525
1002926.....	144	1003003.....	079	1003084.....	525
1002927.....	144	1003004.....	079	1003085.....	879
1002928.....	157	1003005.....	079	1003087.....	872
1002929.....	157	1003006.....	079	1003088.....	872
1002930.....	157	1003007.....	079	1003090.....	877
1002931.....	177	1003008.....	510	1003091.....	880
1002932.....	177	1003009.....	510	1003092.....	880
1002933.....	177	1003010.....	510	1003093.....	877
1002934.....	264	1003011.....	511	1003094.....	872
1002935.....	264	1003012.....	511	1003095.....	872
1002936.....	264	1003013.....	511	1003096.....	880
1002937.....	069	1003014.....	325	1003097.....	878
1002938.....	069	1003015.....	325	1003098.....	879
1002939.....	069	1003016.....	325	1003099.....	880
1002940.....	313	1003017.....	324	1003100	
1002941.....	313	1003018.....	324	1003100.....	879
1002942.....	195	1003019.....	324	1003101.....	870
1002943.....	195	1003024.....	336	1003102.....	868
1002944.....	236	1003025.....	336	1003104.....	851
1002945.....	236	1003026.....	336	1003105.....	851
1002946.....	083	1003027.....	336	1003106.....	849
1002947.....	083	1003028.....	022	1003107.....	131
1002948.....	056	1003029.....	022		
1002949.....	057	1003030.....	018		
1002950.....	057	1003031.....	018		
1002951.....	057	1003032.....	020		
1002952.....	639	1003033.....	020		
1002953.....	639	1003034.....	193		
1002954.....	639	1003035.....	193		
1002955.....	639	1003036.....	457		
1002956.....	569	1003037.....	457		
1002957.....	569	1003038.....	457		
1002958.....	569	1003039.....	457		
1002959.....	569	1003040.....	257		
1002960.....	223	1003041.....	257		
1002961.....	223	1003042.....	257		
1002962.....	164	1003043.....	257		
1002964.....	164	1003044.....	105		
1002965.....	264	1003045.....	105		
1002967.....	241	1003046.....	105		
1002968.....	241	1003047.....	105		
1002969.....	297	1003048.....	107		
1002970.....	297	1003049.....	107		
1002971.....	297	1003050.....	107		
1002973.....	297	1003051.....	107		
1002974.....	297	1003052.....	257		
1002975.....	297	1003053.....	257		

1000926 114

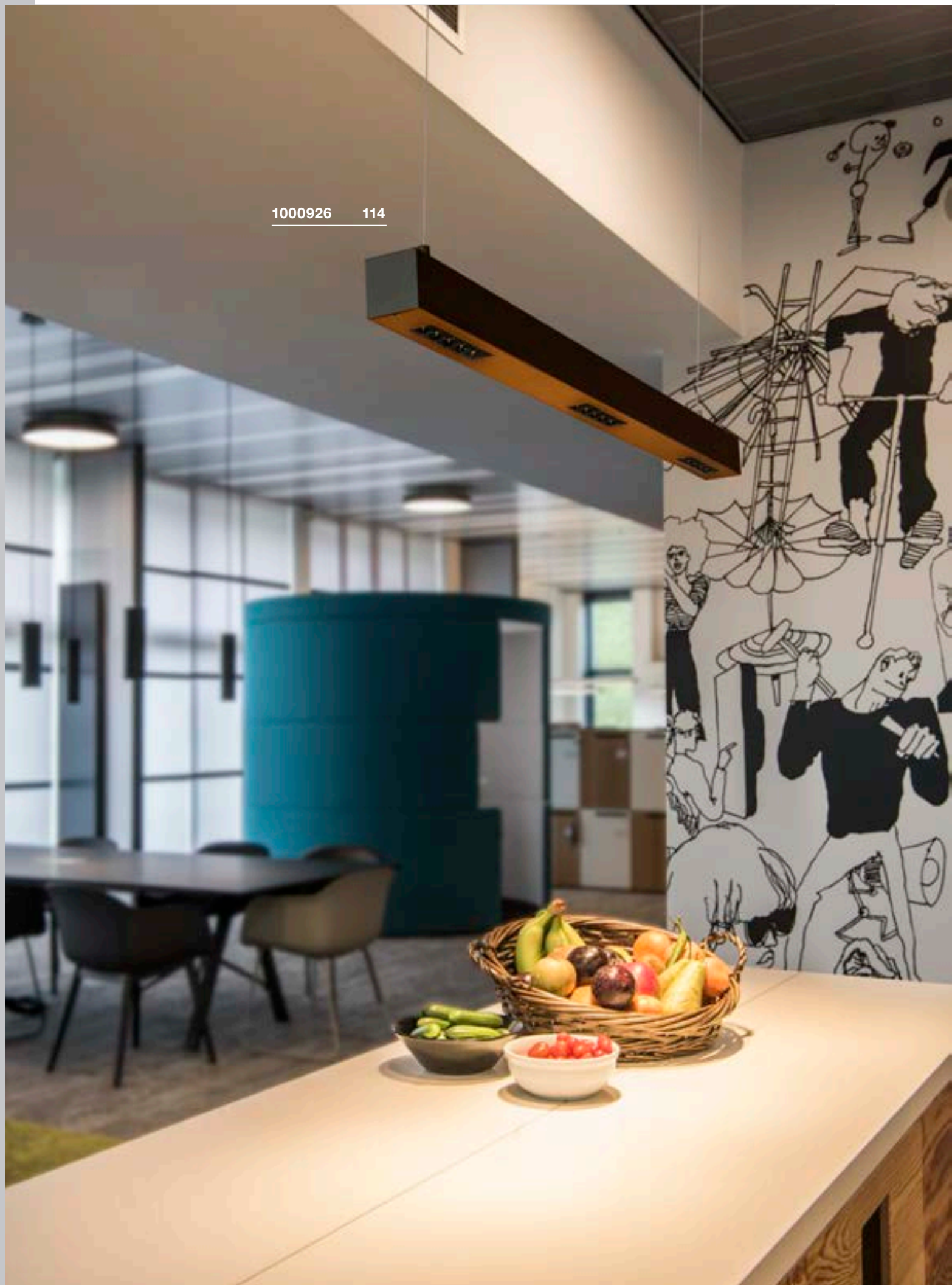

1PHASEN

1PHASEN-AUFBAUSCHIENEN	404
1PHASEN-AUFBAUSCHIENEN Zubehör	405
1PHASEN-EINBAUSCHIENE	402
1PHASEN-EINBAUSCHIENE Zubehör	402

2PHASEN

D-TRACK®	
D-TRACK® 2PHASEN-STROMSCHIENE	380
D-TRACK® 2PHASEN-STROMSCHIENE Zubehör	381

3PHASEN

3PHASEN-EINBAUSCHIENE	373
3PHASEN-EINBAUSCHIENE Zubehör	373

EUTRAC®

EUTRAC® 3PHASEN-AUFBAUSCHIENE	369
EUTRAC® 3PHASEN-AUFBAUSCHIENE Zubehör	370, 371

S-TRACK

S-TRACK 3PHASEN-AUFBAUSCHIENE	365
S-TRACK 3PHASEN-AUFBAUSCHIENE Zubehör	367
S-TRACK 3PHASEN-AUFBAUSCHIENE DALI	339
S-TRACK 3PHASEN-AUFBAUSCHIENE DALI Zubehör	341

A

ABRIDOR 60/100 Pole	574
ABRIDOR SENSOR WL	639
ABRIDOR WL	638
ACCANTO CL, E27	236
ACCANTO PD, E27	083
ACCANTO SPOT SQUARE WL, E27	194
ACCANTO WL, E27	195
ADEGAN FL, E27	540
ADEGAN MANILA FL, E27	539
ADEGAN MANILA PD, E27	533
ADI EL	700
ADJUST 135 EL, square/round, QPAR51	721
ADJUST 190 EL, square/round, QR111	721
ADJUST 265 EL, round, HIT-CE	721
AINOS CW	680

AIXLIGHT®

AIXLIGHT® 150 PD, R2 Office, TR C	117
AIXLIGHT® PD, R2, double, QPAR111	118
AIXLIGHT® PD, R2, quad, QPAR111	118
AIXLIGHT® PRO 50 LED Modul	500
AIXLIGHT® PRO 50 QPAR51 Modul	500
AIXLIGHT® PRO EL, COB LED Modul	502, 503
AIXLIGHT® PRO EL, QPAR111 Modul	501
AIXLIGHT® PRO Zubehör	500, 501

AKALO D83 EL, TRIAC	464
ALAMEA EL	515
ALMINO PD, double, UGR<19	123
ALMINO PD, quad, UGR<19	123, 687
ALMINO WL, UGR<19	190
ALPA CONE 100 Pole, E27	548
ALPA MUSHROOM 45/75 Pole, E27	549
ALTRA DICE CL, QPAR51	267
ALTRA DICE CW, double, QPAR51	267, 284
ALTRA DICE TRACK 1Ph., QPAR51	395
ALTRA DICE TRACK 3Ph., QPAR51	343
ALTRA DICE WL, QPAR51	185
ANDREAS WL, QT-DE12	144
ANELA CL	265
ANELA Display	227
ANELA PD, TRIAC	074
ANGOLUX SENSOR WL	641
ANGOLUX SOLAR WL	641
ANGOLUX WL	641
ANILA EASYTEC® II, QPAR51	412
ANINDA 60 EL	517
ANINDA 120 EL	517
APONI 90/120 Pole, TRIAC	549
APONI WL, TRIAC	617
ARLINA 60 WL	169
ARLINA 60 WL, T16	169
ARLINA 130 WL	169
ARLINA 130 WL, T16	169

AROSA PD, 1,25m, TRIAC	053
AROSA PD, 2m, TRIAC	053
ARROCK ARC Pole, QPAR51	562
ARROCK GRANITE 40/70 Pole, square, E27 ..	561
ARROCK SLOT Pole, QPAR51	570
ARROCK STONE 50/70 Pole	570
ASMARA LV, QR-C51	420
ASSO 70 WL	166
ASSO 300 WL	167
ASSO WL	167
ASTINA CL	264
ASTINA PD, QPAR51	069
ASTINA STEEL WL	655
ASTINA STEEL WL, QPAR51	655
ASTINA UP/DOWN WL, QPAR51	177
ASTINA WL, QPAR51	654
ASTO CW, single, QPAR51	301
ASTO CW, double, QPAR51	301
ASTO CW, triple, QPAR51	301
ASTO CW, quad, QPAR51	301
ASTO TUBE CW, single, QPAR51	295
ASTO TUBE CW, double, QPAR51	295
ASTO TUBE CW, triple, QPAR51	295
AVENTO 30 PD	055
AVENTO 110 PD	055
AVO CW, single, QPAR51	299
AVO CW, double, QPAR51	299
AVO CW, triple, QPAR51	299
AVO CW, quad, QPAR51	299
AVO TRACK 1Ph., QPAR51	387
AVO TRACK 3Ph., QPAR51	343

B

BASKET WL, E27	145
BATO 35 CW, E27	139
BATO 35 CW, TRIAC	139
BATO 35 PD, E27	058
BATO 35 PD, TRIAC	058
BATO 45 CW	238
BATO 45 CW, E27	238
BATO 45 PD, E27	059
BATO 45 PD, TRIAC	058

BATTEN LED

BATTEN LED 220-240V ~50/60Hz	815
BATTEN LED 220-240V ~50/60Hz Zubehör ..	815

BEDSIDE EL, left	446
BEDSIDE EL, right	446
BELA 40 PD	061
BELA 60 PD	061
BENA 120 CW	327
BENA 150 CW	327
BENDO 80/220 Pole, TRIAC	572
BENDO WL, TRIAC	636
BIBA PD, E14	077
BIG NAILS 50/80 Pole	552
BIG NAILS 50/80 Pole, E27	552
BIG NAILS PLUS 50/80 Pole, E27	551
BIG NAILS WL, E27	619
BIG NAUTILUS SP, round, QPAR51	588
BIG PLOT Cover, 2 slots	715
BIG PLOT Cover, 4 slots	715
BIG PLOT Module	714, 715
BIG QUAD UP/DOWN WL	659
BIG QUAD WL	183, 646
BIG THEO CL	678
BIG THEO CL, QPAR111	678
BIG THEO BEAM UP/FLOOD DOWN WL	666
BIG THEO FLOOD UP/DOWN WL	666
BIG THEO UP/DOWN WL, QPAR111	665
BIG THEO WL	651
BIG THEO WL, QPAR111	650
BILAS CW, single, TRIAC	288
BILAS TRACK 1Ph., TRIAC	398
BILAS TRACK 3Ph., TRIAC	349
BIMA 1Ph., single, QPAR51	391
BIMA 1Ph., double, QPAR51	391
BIMA EASYTEC® II, single, QPAR51	411
BIMA 2 EASYTEC® II, double, QPAR51	411
BIMA 3Ph., single, QPAR51	351
BIMA 3Ph., double, QPAR51	351
BISHADE FL, E27	024
BISHADE PD, E27	082
BISHADE TL, E27	024

SLV BLUETOOTH® CONTROL

Wandeinbau Dimmer, TRIAC	835
--------------------------------	-----

BOOKAT Pole, TRIAC	564
BOX UP/DOWN WL, QT-DE12	662
BOX-L WL	661
BOX-L WL, E27	661
BRENDA PD, TRIAC	080
BRENDA TL, Wireless charging	015
BRENDA WL	142
BRICK DOWNUNDER EL	698
BRICK DOWNUNDER EL, E14	698
BRICK EL, asymmetrisch	701
BRICK EL, symmetrisch	701
BRICK MESH EL	701
BULAN CW, E14	682
BULAN GRID CW, E27	682

C

C-POL Pole, E27	555
C-POL WL, E27	618
CARISO WL	172
CHROMBO WL	162

SLV COLOR CONTROL

Bluetooth® Adapter	830
Fernbedienung	829
FLEXLED ROLL MULTICOLOUR RGBW, 24V ..	830
FLEXLED ROLL MULTICOLOUR RGBW 24V Zubehör	830
Master Controller mit Fernbedienung	829
Signalverstärker	830
Slave Controller	829
Wandbedienpanel, Einbau/Aufbau	829

COMET LED LV	425
COMET LV, QR-C51	425
COMMO PD, TCR-TSE	077
CONE FL, E27	543
CONTONE® EL, round/square, starr, TRIAC	457
CONTONE® EL, round/square, verstellbar, TRIAC	457

SLV CONTROL BY TRUST

Fernbedienung 16 Kanal	838
Funk-Einbauschalter	840
Funk-Empfängermodul, 3 Kanal	840
Funk-Multidimmer-Einbau	840
Funk-Steckdosenschalter BE/FR Indoor	839
Funk-Steckdosenschalter BE/FR Outdoor ..	839
Funk-Steckdosenschalter Indoor	839
Funk-Steckdosenschalter IT	839
Funk-Steckdosenschalter Outdoor	839
Funk-Steckdosenschalter UK	839
Internet Controlstation ICS 2000	838
IP56 Anschlussgehäuse, 3 Kanal	840
Wandschalter 1-Fach	838

COSMIC LV, QR-C51	421
COUPA FLEX WL	196
COUPA WL, QT14	197
CRYSTAL EL, TRIAC	449
CUBIX FL, QPAR51	542
CV SPOT SP, short	593
CV SPOT SP, long	593

D**DASAR®**

DASAR® 70 EL, square, QPAR51	729
DASAR® 80 EL, square/round, QPAR51	729
DASAR® 100 PREMIUM EL, round	727
DASAR® 100 PREMIUM EL, square	726
DASAR® 150 PREMIUM EL, round	727
DASAR® 150 PREMIUM EL, square	727
DASAR® 215 EL, round, E27	730
DASAR® 215 EL, square/round, QPAR111 ..	730
DASAR® 218 EL, QR111	730
DASAR® 255 EL	733
DASAR® 270 EL, asymmetrisch	733
DASAR® 270 EL, symmetrisch	733
DASAR® 370 EL, square/round	723
DASAR® 920 EL	725
DASAR® EL, T16	734
DASAR® EXACT 116 EL, square/round, QPAR51	729
DASAR® FLAT 80 EL	722
DASAR® PROJECTOR SP, 12-24V	598
DASAR® PROJECTOR SP, 230V	598

DEKLED EL	450
-----------------	-----

DELFD			
DELFD D, 24V	813		
DELFD D, 24V Zubehör	813		
DELO WL	633		
DELWA WL.....	183, 652		
DENA 30 WL, E14	145		
DEVIN WL, Double	212		
DINGILO EL, round, verstellbar, TRIAC	457		
DIO FLEX PLATE WL.....	208		
DIO FLEX PLATE WL QPAR51.....	207		
DISPLAY	229		
DISPLAY ADL 50 QPAR51	225		
DL 126 EL	450		
DOLIX OUT EL, round, QPAR51	461, 707		
DOLIX OUT EL, round, QR-C51	460, 706		
DOLIX OUT EL, square, QPAR51	461, 707		
DOLIX OUT EL, square, QR-C51	460, 706		
DORISA 20 square.....	216		
DORISA 30	215		
DORISA 40 rectangular	216		
DORISA 50	215		
DOWNUNDER OUT Round	632		
DOWNUNDER OUT Square	632		
DOWNUNDER OUT S EL	699		
DOWNUNDER OUT M EL	699		
DOWNUNDER OUT L EL	699		
DOWNUNDER PUR 80 EL	441		
DOWNUNDER PUR 120 EL	441		
DOWNUNDER PUR 150 EL	441		
E			
EASYTEC® II			
EASYTEC® II SCHIENE	415		
EASYTEC® II SCHIENE Zubehör	415		
ENOLA			
ENOLA B CL, QPAR51.....	265		
ENOLA B CW, single, QPAR51.....	289, 290		
ENOLA B CW, double, QPAR51	289, 290		
ENOLA B PD, QPAR51	070, 399		
ENOLA B TRACK 1Ph., QPAR51.....	390		
ENOLA B WL, QPAR51.....	177, 204		
ENOLA C CL	266, 675		
ENOLA C CL	675		
ENOLA C CL, TRIAC.....	675		
ENOLA C Pole	577		
ENOLA C TRACK 1Ph.....	397		
ENOLA C TRACK 3Ph.....	346		
ENOLA C UP/DOWN WL	656		
ENOLA C WL.....	628		
ENOLA PD, E27.....	071		
ESKINA 30/80 Pole	577		
ESKINA D Display	670		
ESKINA SPOT/SPOT SENSOR CW	689		
EURO CUBE 3Ph.....	353		
EURO SPOT TRACK 1Ph.....	392		
EURO SPOT TRACK 1Ph. QPAR111	393		
EURO SPOT TRACK 1Ph. QPAR51	392		
EURO SPOT TRACK 3Ph.....	361		
EURO SPOT TRACK 3Ph., DALI, 173mm	335		
EURO SPOT TRACK 3Ph., DALI, 235mm	334		
EURO SPOT TRACK 3Ph., DALI, 255mm	334		
EURO SPOT TRACK 3Ph., QPAR111	360		
EURO SPOT TRACK 3Ph., QPAR51	360		
EURO SPOT TRACK 3Ph., TRIAC	361		
F			
F-POL Pole, E27	555		
F-POL WL, E27.....	618		
FENDA			
FENDA BOW BASIS FL, E27.....	022		
FENDA Deckenrosette, E27.....	234		
FENDA FL, E27	018, 020		
FENDA Glasschirm.....	044		
FENDA Halbschirm	148		
FENDA Ø 15 cm, rund	018, 020, 046		
FENDA Ø 20 cm, rund	192		
FENDA Ø 30 cm, rund	019, 021, 047, 235		
FENDA Ø 40 cm, rund	022, 044		
FENDA Ø 45 cm, rund	019, 021, 022, 047, 235		
FENDA Ø 70 cm, rund	019, 021, 047, 235		
FENDA PD, E27	044		
FENDA TL, E27.....	018, 020		
FENDA WL, Basis, E27	148, 192		
FENDA WL, E27.....	193		
FERA 25 CL	241		
FERA 25 CL, DALI.....	241		
FILI, Klemme WL, QPAR51.....	224		
FILI, Rosette WL, QPAR51	224		
FITU CW, E27	285		
FITU FL, E27	029		
FITU PD, E27	036, 037, 038, 039		
FITU TL, E27.....	010		
FITU WL, E27	146		
FLAC BEAM® SP.....	605		
FLAT FRAME BASIC EL, QT9.....	444		
FLAT FRAME CURVE EL, QT9.....	443		
FLATT 65/100 Pole	569		
FLATT SENSOR WL.....	639		
FLATT WL.....	639		
FLEXLED ROLL			
FLEXLED ROLL MULTICOLOUR RGBW, 24V.....	810, 830		
FLEXLED ROLL MULTICOLOUR RGBW, 24V Zubehör.....	810, 830		
FLEXLED ROLL SELECT, 24V	811		
FLEXLED ROLL SELECT, 24V Zubehör.....	797		
FLEXLED ROLL, 24V.....	799, 805, 812		
FLEXLED ROLL, 24V Zubehör.....	799, 805		
FLEXLED STRIP, 24V	800, 801		
FLEXSTRIP LED HIGH LUMEN, 24V.....	803		
FLEXSTRIP LED HIGH LUMEN 24V Zubehör.....	803		
FLEXSTRIP LED RGB, 24V.....	809		
FLEXSTRIP LED RGB 24V Zubehör.....	809		
FLOOD LIGHT 25 SP	606		
FLOOD LIGHT 32 SP	606		
FORCHINI 40 PD, E27	062		
FORCHINI 50 PD, E27	062		
FORCHINI 70 PD, E27	062		
FORCHINI M 40 TRACK 1Ph., E27.....	401		
FORCHINI M 40 TRACK 3Ph., PD, E27	363		
FORCHINI M 40 PD, E27	065		
FORCHINI M 50 PD, E27	065		
FRAME BASIC EL.....	444		
FRAME BASIC EL, HV.....	444		
FRAME BASIC SET EL.....	451		
FRAME CURVE EL.....	443		
FRAME CURVE EL, HV	443		
G			
GALEN 100 SP.....	609		
GALEN SP, TRIAC.....	609		
GIMBLE IN 68 EL.....	508		
GIMBLE IN 100 EL.....	508		
GIMBLE IN 150 EL.....	508		
GIMBLE IN 175 EL.....	509		
GIMBLE OUT EL	720		
GLASSA CW, round, E27	317		
GLASSA CW, square, E27	317		
GLENOS®			
GLENOS® Eck-Profil 272	768		
GLENOS® Eck-Profil 2720 ubehör	769		
GLENOS® Linear-Einbau-Profil 250	767		
GLENOS® Linear-Einbau-Profil 2508 ubehör	767		
GLENOS® Linear-Profil 110	764		
GLENOS® Linear-Profil 1107 ubehör.....	765		
GLENOS® PD, 1m, 1-10V	112		
GLENOS® PD, 2m, 1-10V	112		
GLENOS® Profi-Einbau- rofil 883	774		
GLENOS® Profi-Einbau- rofil 8832 ubehör	775		
GLENOS® Profi- rofil 202	776		
GLENOS® Profi- rofil 2020 ubehör	777		
GLENOS® Profi- rofil 303	770		
GLENOS® Profi- rofil 3030 ubehör	771		
GLENOS® Profi- rofil 497	772		
GLENOS® Profi- rofil 4970 ubehör	773		
GLENOS® 60	219		
GLOO PURE 27/44/70 Pole, E27	548		
GLOO PURE WL, E27	614		
GLU-TRAX®			
GLU-TRAX® Schiene	433		
GLU-TRAX® Schiene Zubehör.....	433		
GRAFIT 30/60 Pole, E27	557		
GRAFIT WL, E27.....	620		
GRAZIA			
GRAZIA 10 Aufbauprofil, Flac	749		
GRAZIA 10 Aufbauprofil, tandard	749		
GRAZIA 10 Einbauprofi	749		
GRAZIA 10 Zubehör.....	750, 751		
GRAZIA 20 Aufbauprofil, Flac	753		
GRAZIA 20 Aufbauprofil, tandard	753		
GRAZIA 20 Einbauprofi	754		
GRAZIA 20 Zubehör.....	755, 756, 757		
H			
H-LIGHT EL, oval, TRIAC	458		
H-LIGHT EL, round, TRIAC	458		
H-LIGHT EL, TRIAC	459		
H-POL 30/60 Pole	566		
H-POL Twin 30/60 Pole.....	567		
H-PROFIL			
H-PROFIL 2 m.....	759		
H-PROFIL 2 m Zubehör	760, 761		
HANG UP 120 PD, TRIAC	108		
HELIA 30 PD.....	072		
HELIA 30 PD, TRIAC.....	073		
HELIA 40 PD.....	072		
HELIA 40 PD, TRIAC.....	073		
HELIA 50 TRACK 1Ph.....	397		
HELIA 50 TRACK 3Ph.....	346		
HELIA 50 TRACK EASYTEC® II.....	410		
HELIA CW, single, TRIAC.....	292, 691		
HELIA CW, double, TRIAC.....	292, 691		
HELIA EL	447		
HELIA Pole, single, TRIAC.....	580, 583		
HELIA Pole, double, TRIAC	581, 583		
HELIA SENSOR Single	580		
HELIA SPOT S SP, single, TRIAC.....	599		
HELIA SPOT L SP, single, TRIAC.....	599		
HELIA UP/DOWN WL, TRIAC.....	653		
HELIA WL, TRIAC	629		
HORN EL, QPAR51.....	473		
HORN MAGNA EL	474		
HORN MEDI EL	474		
HORN MINI EL.....	474		
HORN-A EL, QPAR51	471		
HORN-O EL, QPAR51.....	471		
HORN-T EL, QPAR11	472		
HORN-T EL, QPAR51	471		
I			
I-PENDANT PRO PD, 1195x295mm, UGR<19, 1-10V	107		
I-PENDANT PRO PD, 1195x295mm, UGR<22, 1-10V	106		
I-PENDANT PRO PD, 1195x295mm, 1-10V	107		
I-PENDANT PRO PD, 1195x295mm, DALI	107		
IMPERVA 120 CW.....	687		
IMPERVA 150 CW.....	687		
INDA CW, QPAR51	283		
INDI REC EL, QPAR51	451		
IPERI 50 Pole.....	575		
IPERI WL	642		
IVED GOOSE WL, Rosette	209		
K			
KADUX EL, single, 1-10V	499		
KADUX EL, single, QPAR111	497		
KADUX EL, single, QPAR51	496		
KADUX EL, single, TRIAC.....	498		
KADUX EL, double, 1-10V.....	499		
KADUX EL, double, QPAR111.....	497		
KADUX EL, double, QPAR51	496		
KADUX EL, double, TRIAC	498		
KADUX EL, triple, QPAR51	496		
KADUX EL, triple, TRIAC	498		
KAHOLO EL, E27	452		
KALU CW, single, QPAR111.....	304		
KALU CW, single, TRIAC.....	306		
KALU CW, double, QPAR111	304		
KALU CW, double, TRIAC	306		
KALU CW, triple, QPAR111	304		

KALU CW, triple, TRIAC	306
KALU CW, quad, long, TRIAC	307
KALU CW, quad, square, TRIAC.....	307
KALU CW, quad, wide, TRIAC.....	307
KALU FL, single, QPAR111	010
KALU TRACK 1Ph., QPAR111.....	395
KALU TRACK 1Ph., TRIAC	395
KALU TRACK 3Ph., QPAR111.....	358
KALU TRACK 3Ph., QR111	358
KALU TRACK 3Ph., TRIAC.....	359
KAMUELA ECO EL, round, TRIAC... 463, 711, 745	
KANO EASYTEC® II, QPAR51	412
KARDAMOD CL, round, single, QPAR111	276
KARDAMOD CL, round, double, QPAR111.....	276
KARDAMOD CL, square, single, QPAR111	274
KARDAMOD CL, square, single, QR111	275
KARDAMOD CL, square, double, QPAR111	274
KARDAMOD CL, square, double, QR111	275
KARPO 30 CW, single.....	205, 286
KARPO 30 CW, single, TRIAC	286
KARPO 30 EL	447
KARPO FL	025
KARPO TL	025
KARPO UP/DOWN WL	177
KARPO WL.....	205

KELVIN CONTROL

KELVIN CONTROL-STRIP, 24V	807, 834
KELVIN CONTROL-STRIP, 24V Zubehör	807, 834

SLV KELVIN CONTROL

Bluetooth® Adapter	833
Fernbedienung	833
KELVIN CONTROL-STRIP, 24V	834
KELVIN CONTROL-STRIP, 24V Zubehör	834
Master Controller mit Fernbedienung	833
Signalverstärker	833
Slave Controller	833
Wandbedienpanel, Einbau/Aufbau	833

KENAI

KENAI Aufbauprofil	762
KENAI Aufbauprofil ubehör	763

KENGA 17 TL	537
KENGA 45 FL, E27	537
KENKUA SPOT WL, E27	194
KENKUA WL, E27	194
KERAS ELT WL, E27.....	622
KINI EL, TRIAC	705
KIROCONE TL, E27	534

L

L-LINE 60	220
L-LINE 120	220
LASSON 10 PD, E27.....	084
LASSON 45 PD, E27.....	084
LASSON 80 PD, E27.....	085
LASSON WL, E27	149

LEUCHTMITTEL

LED A60 E27	876, 877, 878
LED A60 E27, CCT	820, 876
LED A60 E27, Mirrorhead, Chrome	879
LED A60 E27, Mirrorhead, Gold	879
LED A60 E27, RGBW.....	820, 876
LED C35 E14	875
LED Filament G9.....	868
LED FRISBEE E27	877
LED G125 E27	880
LED G125 E27, Mirrorhead, gold.....	880
LED G125 E27, Rauchglas.....	880
LED G95/G125 E27	880
LED G95/G125 E27, Rauchglas.....	880
LED PAR30 E27.....	881
LED PAR38 E27	881
LED QPAR111 GU10	872, 873, 874
LED QPAR111 GU10, CCT,	
SLV VALETO®	821, 872
LED QPAR111 GU10, RGBW,	
SLV VALETO®	821, 872
LED QPAR51 GU10	870, 871
LED QPAR51 GU10, CCT,	
SLV VALETO®	820, 870
LED QR111 G53	874, 875
LED QR51 GU5.3	869
LED QT-DE12 R7S 118 mm.....	868

LED QT-DE12 R7S 78 mm.....	868
LED QT14 G9	868
LED ST58 E27	879
LED ST64 E27	879
LED T32 E27	879
LED T32 FILAMENT GU10	870
LED T38 E27	877
LED T45 E27	876, 877
LED TCR-TSE GX53.....	881

LED PANEL 300x120mm	525
LED PANEL 600x600mm	524, 525
LED PANEL 620x620mm	524, 525
LED SAIL WL	173
LED SPIKE SP	590

LED-STRIP

LED-STRIP, 24V	798
LED-STRIP, 24V Zubehör	798

LENITO TRACK 3Ph.....	345
LENITO WL.....	188, 227
LIGHT EYE® 90 TRACK EASYTEC® II,	
QPAR51.....	413
LIGHT EYE® 90 1Ph., QPAR51	388
LIGHT EYE® 90 CW, single, QPAR51	291
LIGHT EYE® 90 CW, double, QPAR51	291
LIGHT EYE® 90 PD, GU10.....	050
LIGHT EYE® 150 TRACK 3Ph., QPAR51	344
LIGHT EYE® 150 TRACK EASYTEC® II,	
PD, QPAR111	414
LIGHT EYE® 150 TRACK EASYTEC® II,	
QPAR111.....	413
LIGHT EYE® 150 3Ph., PD, QPAR111	363
LIGHT EYE® 150 PD, QPAR111	050, 399
LIGHT PIPE 60/90 PD, TRIAC	075
LIGHT PIPE 60/90/140 Pole, TRIAC	028, 550
LIGHTPOINT EL	448
LIPA CW, TRIAC.....	683
LIPSY® 30 CW, Dome	311
LIPSY® 30 CW, Drum	312
LIPSY® 30 CW, VALETO®	310, 825
LIPSY® 40 CW, Dome	311
LIPSY® 40 CW, Drum	312
LIPSY® 40 CW, Drum, DALI	313
LIPSY® 40 CW, VALETO®	310, 825
LIPSY® 50 CW, Dome	311
LIPSY® 50 CW, Drum	312
LIPSY® 50 CW, Drum, DALI	313
LIPSY® 50 CW, VALETO®	310, 825
LISENNE 40/70 Pole, E27	546
LISENNE CL, E27	673
LISENNE PD, E27	076
LISENNE TL, E27.....	541
LISENNE WL, E27	143
LOGS 40/70 Pole.....	558
LOGS IN L WL	157
LOGS IN L WL, TRIAC	157
LOGS IN WL	156
LOGS WL	664
LONG GRILL CW	329
LYNAH PD, quad	119
LYNAH WL.....	184

M**M-TRACK**

M-TRACK Adjustable Light	430
M-TRACK Spot	430
M-TRACK Stromschiene.....	431
M-TRACK Stromschiene Zubehör	431

MAGANDA TL.....	012
MAGANDA WL.....	210
MALANG CL, E27	260
MALANG CW, SLV VALETO®.....	067, 322, 824
MALO Display WL	228
MALU CL	679
MALU Pole.....	576
MALU WL	644
MANA OUT WL	660
MANA Schirm	151, 153, 199
MANA WL, Basis	198
MANA WL, Basis, TRIAC.....	150, 152
MARONA CW, TRIAC.....	314
MARYLIN WL	212
MECANICA PLUS FL.....	027
MECANICA PLUS TL.....	027

MEDO

MEDO 30 CL, 1-10V	092, 248
MEDO 30 CL, TRIAC.....	090, 246
MEDO 30 CORONA CW, DALI	096, 252
MEDO 30 CORONA CW, TRIAC.....	094, 250, 321
MEDO 30 EL, Frame	520
MEDO 30 EL, Frameless	518
MEDO 40 CL, 1-10V	092, 248
MEDO 40 CL, TRIAC.....	091, 247
MEDO 40 CORONA CW, DALI	096, 252
MEDO 40 CORONA CW, TRIAC.....	095, 251, 321
MEDO 40 EL, Frame	520
MEDO 40 EL, Frameless	519
MEDO 60 CL, 1-10V	092, 248
MEDO 60 CL, Square	254
MEDO 60 CL, Square, 1-10V	098
MEDO 60 CL, Square, DALI	099, 255
MEDO 60 CORONA CW, DALI	096, 252
MEDO 60 CORONA CW, TRIAC.....	095, 251, 321
MEDO 60 EL, Frame	520
MEDO 60 EL, Frameless	519
MEDO 90 CL, 1-10V	093, 249
MEDO 90 CORONA CL, DALI	097, 253
MEDO 90 CORONA CL, TRIAC.....	095, 251
MEDO 90 EL, Frame	521
MEDO 90 EL, Frameless	519
MEDO RING 60 PD, DALI.....	101
MEDO RING 60 PD, 1-10V.....	100
MEDO RING 90 PD, 1-10V.....	100

MELAN CW, E27.....	316
MERADO FLOOD TRACK 3Ph., TRIAC.....	345
MERADO FLOOD WL.....	189
MERIDIAN BOX WL, E27.....	626, 627
MERIDIAN BOX WL, E27, MR	627
MERIDIAN WL, E27	623
MERVALED SENSOR WL.....	637
MERVALED WL	637
MIBO UP/DOWN WL, QT14	214
MILANDO 2 EL	479
MILANDO 5 EL	479
MILANDO 10 EL	479
MOBALA EL	445
MOLAT CL, E27	672
MOLAT PD, E27	532
MOLAT Pole, E27	550
MOLAT WL, E27	614
MOLDI 32 CW	315
MOLDI 46 CW	315
MOLDI 46 CW, Sensor	315
MYRA CW, single, QPAR51	690
MYRA WL, double, QPAR51	690
MYRA DISPLAY WL, curved, QPAR51	671
MYRA DISPLAY WL, straight, QPAR51	671
MYRA SPOT Double, GU10	583
MYRA UP/DOWN WL, QPAR51	653

N

NAGY 75 CL, QPAR51	264
NAPIA TWIN WL	200
NAPIA WL.....	200
NAUTILUS 10 SP, round, QPAR51.....	588, 589
NAUTILUS 10 SP, square	589
NAUTILUS 10 SPOT SP, QPAR51.....	597
NAUTILUS 10 WL, Square	689
NAUTILUS 25 CL	688
NAUTILUS SP	597
NAUTILUS SP, QR-C51.....	595
NAUTILUS SPOT SP, PAR38, E27	597
NAUTILUS WL, square.....	689
NEPRO DISPLAY QT-DE12	228

NEW TRIA

NEW TRIA 45 Single, round, CS.....	488
NEW TRIA 45 Single, square, CS	488
NEW TRIA 68 Single, round, CS, TRIAC	490
NEW TRIA 68 Single, square, CS, TRIAC	490
NEW TRIA 68 Single, round, CS.....	489
NEW TRIA 68 Single, square, CS	489
NEW TRIA 68 Single, round, CS/LS,	
QPAR51.....	482
NEW TRIA 68 Single, square, CS/LS,	
QPAR51.....	482
NEW TRIA 68 Single, round, CS/LS,	
TRIA.....	491
NEW TRIA 68 Single, square, CS/LS,	
TRIA.....	491

NEW TRIA 77 Single, round, CS.....	492
NEW TRIA 77 Single, square, CS	492
NEW TRIA 78 Single, round, CS, QPAR51.....	485
NEW TRIA 78 Single, square, CS, QPAR51.....	485
NEW TRIA 78 Single, round, LS, QPAR51.....	484
NEW TRIA 78 Single, square, LS, QPAR51.....	484
NEW TRIA 110 Single, round, CS, TRIAC	494
NEW TRIA 110 Single, square, CS, TRIAC.....	495
NEW TRIA 150 Single, round, CS, 1-10V.....	495
NEW TRIA 150 Single, square, CS, 1-10V	495
NEW TRIA 150 Single, round, LS, QPAR111	487
NEW TRIA 150 Single, square, LS, QPAR111	487
NEW TRIA 155 Double, CS	493
NEW TRIA 155 Double, CS, QPAR51	486
NEW TRIA 300 Double, CS, QPAR111	487

NIEDERVOLT-SEILSYSTEM

NIEDERVOLT-SEILSYSTEM.....	428, 429
NIEDERVOLT-SEILSYSTEM Zubehör	429

NOBLO CW, single, TRIAC.....	297
NOBLO CW, double, TRIAC	297
NOBLO CW, triple, TRIAC	297
NOBLO SPOT 1Ph.....	396
NOBLO SPOT 1Ph., Triple Track Set.....	386
NOBLO SPOT 3Ph.....	346
NOBLO SPOT LV, Rope Track	424
NOTAPO WL.....	440

O

OCCULDAS 13 DL, TRIAC	263
OCCULDAS 13 DL, indirect, TRIAC	262
OCCULDAS 13 MOVE DL, TRIAC	263
OCCULDAS 14 EL, indirect, TRIAC	469
OCCULDAS 14 MOVE EL, TRIAC	469
OCCULDAS 23 DL, indirect, TRIAC	263
OCCULDAS 23 EL, indirect, TRIAC	469
ONE 40 WL, DALI	140
ONE 60 PD, DALI	103
ONE 60 WL, DALI	140
ONE 80 PD, DALI	103
ONE TRIPLE PD, DALI	103
OPEN GRILL CW	329
OPEN GRILL PD, Single Twist	116
OPEN GRILL PD, Double Twist.....	116
ORDI SENSOR WL	640
ORDI WL	640
OSSA 180 WL, QT-DE12	168
OSSA 300 WL, QT-DE12	168
OTOS GLAS Pole, E27	547
OUT 65 EL, round, TRIAC.....	708
OUT 65 EL, square, TRIAC.....	708
OUT-BEAM UP/FLOOD Down WL.....	669
OUT-BEAM UP/DOWN WL.....	668
OUT-BEAM UP/DOWN WL, QT-DE12.....	668
OUTDOOR BEAM 11 SP	604
OUTDOOR BEAM 22 SP	604
OUTDOOR BEAM 28 SP	605

P

P-LIGHT CL	742
P-LIGHT CW.....	740, 741, 743
PANEL 60 CL, round, DALI.....	257
PANEL 60 CL, round, TRIAC.....	256
PANEL 60 EL, round	522
PANEL 60 PD, 1-10V	104
PANEL 60 PD, Round, DALI	105
PANEL CL, 1200x300mm, DALI.....	257
PANEL CL, 1200x300mm, TRIAC.....	257
PANTILO 16 PD, E27	079
PANTILO 20 PD, E27	079
PANTILO 28 PD, E27	079
PARA 380 PD, E27	128
PARA CONE 14 1Ph., PD, QPAR51	400
PARA CONE 14 1Ph., QPAR51	389
PARA CONE 14 3Ph., PD, QPAR51	363
PARA CONE 14 3Ph., QPAR51	344
PARA CONE 20 PD, E27.....	066
PARA CONE 30 PD, E27	066
PARA CONE 40 PD, E27	066
PARA DOME E27	127
PARA DOME PD, E27	127, 129
PARA FLAC PD/CL	130

PARA FLAC PD/CL, DALI	131
PARA MULTI PD, DLMI.....	129
PATTA-F EL, round, TRIAC	465, 709
PATTA-F EL, square, TRIAC	465, 709
PATTA-I EL, round, TRIAC	466, 467, 710, 711
PATTA-I EL, square, TRIAC.....	466, 467, 710, 711
PAVANO 300x1200mm	527
PAVANO 600x600mm	527
PAVANO 620x620mm	527
PEMA® WL	184, 633, 643
PEMA® WL, E27	643
PHELIA FL, E27	026
PHELIA PD, E27	056, 057
PHELIA TL, QPAR51	026
PHELIA WL, QPAR51	203
PHOTONIA CL, E27	672
PHOTONIA PD, E27	532
PHOTONIA Pole, E27	547
PHOTONIA TL, E27	541
PHOTONIA WL, E27	614
PIKA EL, round, QPAR51	455
PIKA EL, round, QPAR51, starr	454
PIKA EL, square, QPAR51, schwenkbar	455
PIKA EL, square, QPAR51, starr	455
Piktogrammfolien	740, 741, 743
PIPOFLEX WL	206

PLASTRA

PLASTRA 101 WL, E14.....	180
PLASTRA 104 CL, E27	240
PLASTRA 104 WL, QT14	174
PLASTRA 105 CL, E27	240
PLASTRA 15 CL, single, QPAR51.....	272
PLASTRA 25 CL, double, QPAR51	273
PLASTRA 25 PD, cone, TCR-TSE	048
PLASTRA 25 PD, round, TCR-TSE	049
PLASTRA 25 PD, TCR-TSE	049
PLASTRA 35 CL, triple, QPAR51	273
PLASTRA CL	240
PLASTRA CL, QPAR51	272
PLASTRA EL, round, QPAR51	453
PLASTRA EL, square, QPAR51	453
PLASTRA PD, QPAR51	070
PLASTRA UP/DOWN WL, curve.....	174
PLASTRA WL.....	137
PLASTRA WL, cone, TCR-TSE.....	180
PLASTRA WL, Cube, QT14.....	155
PLASTRA WL, curve	170
PLASTRA WL, Curve, QT-DE12.....	180
PLASTRA WL, QPAR51	159, 175
PLASTRA WL, rectangular, QT-DE12.....	154
PLASTRA WL, slot, E14	159
PLASTRA WL, Square.....	137

POLE PARC 90/150/200 Pole	556
POLE PARC CL	675
POLE PARC UP/DOWN WL	657
POLE PARC WL	631
POWER TRAIL-LITE® EL, round	717
POWER TRAIL-LITE® EL, square	717
POWER-LED SPOT, GLU-TRAX®	432

PROFIL-STRIP

PROFIL-STRIP GRAND, 24V	787
PROFIL-STRIP GRAND, 24V Zubehör.....	787
PROFIL-STRIP SELECT, 24V	795
PROFIL-STRIP STANDARD, 24V	782
PROFIL-STRIP STANDARD, 24V Zubehör	783
PROFIL-STRIP X-SLIM, 24V	793

PURI CW, single, QPAR51.....	303
PURI CW, double, QPAR51	303
PURI CW, quad, QPAR51	303
PURI CW, triple, QPAR51	303
PURI TRACK 1Ph., QPAR51	387, 388
PURI TRACK 1Ph., Triple Track Set	386
PURI TRACK 3Ph., QPAR51	350, 351
PURIA TRACK 1Ph., QPAR51	387
PURISA WL, E27	145

Q

Q-LINE® CL, 1m, BAP.....	259
Q-LINE® CL, 2m, BAP.....	259
Q-LINE® PD, 1m, BAP, TRIAC	114
Q-LINE® PD, 2m, BAP, TRIAC	114
Q-LINE® PD, DALI, single	113
Q-LINE® PD, single.....	113
Q-LINE® WL.....	221

QRB LV, QR111	423
QUAD Pole	579
QUAD UP/DOWN 12 WL.....	158, 658
QUAD UP/DOWN 15 WL.....	158, 658
QUAD WL.....	183, 646
QUADRASYL 75 Pole, TCR-TSE	575
QUADRASYL CW, TCR-TSE	645
QUADRASYL WL, TCR-TSE	645
QUADRULO SENSOR WL, E27	624
QUADRULO WL, E27	625

R

RASCALI 45/65 Pole	565
RASCALI WL	634
RASTO 120 CL, double.....	258
RASTO 125 CL, double.....	258
RASTO 150 CL, double.....	258
RASTO 155 CL, double.....	258
RENISTO S EL, round, Gehäuse, TRIAC	477
RENISTO S EL, square, Gehäuse, TRIAC	476
RENISTO M EL, round, Gehäuse, TRIAC	477
RENISTO M EL, square, Gehäuse, TRIAC.....	476
RENISTO L EL, round, Gehäuse, TRIAC	477
RENISTO L EL, square, Gehäuse, TRIAC.....	476
RETRATO WL	223
REVILO D-TRACK®.....	378
REVILO TRACK D-TRACK®	378
RILO EL	514
ROCCI EL, round.....	719
ROCCI EL, square.....	719
ROTBALL 25 CL, E27	260
ROTBALL 25/40 PD, E27	533
ROTBALL 25/40/50 FL, E27	538
ROTBALL 25/40/50 PD, E27	080
ROTBALL 40 CL, E27	260
ROX ACRYL 30/60/90 Pole, E27	553
ROX ACRYL 30/60/90 Pole, TRIAC	553
ROX ACRYL CL, E27	676
ROX CL, GX53.....	676
ROX CL, QPAR111	266, 676
ROX UP/DOWN WL, QPAR111	178, 656
ROX WL, QPAR111.....	178, 630
RUBA 10/16/20 CW	681
RUBA 10/16/20 CW, Sensor	681
RUSTY® 40/70 Pole	545, 560
RUSTY® 40/70 Pole, E27	545, 560
RUSTY® CONE 40/70 Pole, E27	544
RUSTY® CONE FL, E14	544
RUSTY® PATHLIGHT 40/70 Pole	573
RUSTY® PATHLIGHT Pole, TCR-TSE	573
RUSTY® SLOT 50/80 Pole.....	571
RUSTY® SLOT 50/80 Pole, E27	571

S

SAIL WL	647
SALUNA LV, QR-C51	422
SEDO 14 WL	164
SEDO 21 WL	164
SEDO 7 WL	164
SENER 12 CW, round, TRIAC	325
SENER 12 CW, square, TRIAC.....	324
SENER 12 EL, round	510
SENER 12 EL, square.....	511
SENER 18 CW, round, TRIAC	325
SENER 18 CW, square, TRIAC.....	324
SENER 18 EL, round	510
SENER 18 EL, square.....	511
SENER 24 CW, round, TRIAC	325
SENER 24 CW, square, TRIAC.....	324
SENER 24 EL, round	510
SENER 24 EL, square.....	511
SHELL 15 WL, TRIAC	186
SHELL 30 WL, TRIAC	186
SIGHT 60 CW	328
SIGHT 115 CW	328
SIGHT TRACK 3Ph	349
SIGHT TRACK 3Ph., DALI.....	337
SIGHT TRACK 3Ph., PD.....	362
SIMA CW, round, Sensor	319
SIMA CW, round, TRIAC	318
SIMA CW, square, Sensor.....	319
SIMA CW, square, TRIAC	319
SITRA 360 CW, TCR-TSE.....	690
SITRA 360 Pole, TCR-TSE.....	582
SITRA 360 SPIKE SP, single, TCR-TSE.....	591
SITRA 360 SPIKE SP, double, TCR-TSE.....	591
SITRA CL, TCR-TSE.....	674

SITRA CUBE WL.....	663
SITRA CUBE WL, TCR-TSE.....	663
SITRA UP/DOWN WL.....	654
SITRA UP/DOWN WL, TCR-TSE.....	654
SITRA WL.....	629
SITRA WL, TCR-TSE.....	629
SLOTBOX 40/70 Pole.....	568
SLOTS 45 Pole.....	563
SLOTS 65 Pole.....	563
SLOTS WL.....	616
SOLASTO EL, square/round.....	718
SOLID CUBE WL, QT14.....	155
SOLO 90° GLU-TRAX®, QR-C51.....	432
SOPRANA CL, E27.....	237
SOPRANA OVAL WL, E27.....	147
SOPRANA PD, E27.....	082
SOPRANA WL, E27.....	149
SPHERA 45 PD, TRIAC.....	068
SPHERA 75 PD, TRIAC.....	068
SPOODI 13 SP, SENSOR.....	603
SPOODI 15 SP.....	600
SPOODI 20 SP.....	601
SPOODI 20 SP, SENSOR.....	603
SPOODI 31 SP.....	603
SPOT 79 CW, QPAR51.....	283
SPOT CW, E27.....	282
SPOT DISPLAY E27.....	225
SPOT T 3Ph.....	348
SPOT TRACK 1Ph., E27.....	388
SPOT TRACK 3Ph., E27.....	342
SQUARE C CL, E27.....	677
SQUARE CL, TRIAC.....	677
SQUARE Pole 30/60/90 Pole, TRIAC.....	559
SQUARE TURN WL, G9.....	657
SQUARE WL, E27.....	620
SQUARE WL, TRIAC.....	620
STIX WL.....	203
STRUCTEC 1Ph.....	398
STRUCTEC 3 Ph., R9.....	356
STRUCTEC 3Ph.....	356
STRUCTEC 3Ph., DALI.....	336
STRUCTEC ZOOM 3Ph.....	357
SUN / BIG SUN PD, E27.....	080
SUPROS 78 CL, TRIAC.....	277
SUPROS 78 EL, Move, TRIAC.....	505
SUPROS 78 EL, TRIAC.....	504
SUPROS 78 PD.....	124
SUPROS 78 TRACK 3Ph., TRIAC.....	354
SUPROS 78 Up/Down WL.....	179
SUPROS CL.....	277
SUPROS CL, Move.....	277
SUPROS EL.....	506
SUPROS EL, Move.....	507
SUPROS PD.....	125
SUPROS TRACK 3Ph.....	355
SYNA SP.....	590
SYROS LV, QR-C51.....	421

T

TANI WL, QT-DE12.....	162
TEC KALU CL, double, TRIAC.....	268
TEC KALU CL, quad, TRIAC.....	268
TEC KALU TRACK 3Ph., double, TRIAC.....	352
TEC KALU TRACK 3Ph., quad, TRIAC.....	352
TELESKOP LV, QR-C51.....	420
TENORA CL, E27.....	237
TENORA WL, E27.....	191
TERANG 200 CW.....	684
TERANG 270 CW.....	684
TERANG 270 CW Sensor.....	684
THEO CL, QPAR51.....	678
THEO PATHLIGHT Pole, single.....	578
THEO PATHLIGHT Pole, double.....	578
THEO UP/DOWN WL, QPAR51.....	161, 665
THEO WL, QPAR51.....	650
TODAY Display.....	670
TODAY PRO Display.....	670
TONGA® 1Ph., PD, E14.....	400
TONGA® EASYTEC® II, PD, E14.....	414
TONGA® PD, E14.....	077
TONILA TL.....	011
TOTHEE CW, TRIAC.....	287
TOTHEE D-TRACK®, TRIAC.....	378
TRAIL-LITE® 60 EL.....	716
TRAPECCO DOWN WL.....	644
TRAPECCO Pole.....	576
TRIADDEM PD, E27.....	083
TRILEDO CL, single, round.....	271

TRILEDO CL, single, round, QPAR51.....	269
TRILEDO CL, single, square.....	271
TRILEDO CL, single, square, QPAR51.....	269
TRILEDO CL, double, square.....	271
TRILEDO CL, double, square, QPAR51.....	270
TRUKKO 60/90 WL.....	211
TRUKKO WL.....	211
TRUST 30/60 Pole.....	551
TRUST WL.....	619

V

SLV VALETO®

12/24V Strip Steuermodul CCT.....	823
12/24V Strip Steuermodul RGBW.....	823
15W, LED Treiber.....	823
Fernbedienung.....	822
Fernbedienung, CCT/RGBW.....	822
Gateway.....	820
LIPSY® 30 CW, VALETO®.....	825
LIPSY® 40 CW, VALETO®.....	825
LIPSY® 50 CW, VALETO®.....	825
MALANG CW, SLV VALETO®.....	824
Phase cut dimmer.....	822

VALETO® LED PANEL 595x595mm	
UGR>19.....	523
VALETO® LED PANEL 620x620mm,	
UGR<19.....	523
VANO WING SP, 1-10V.....	608
VAP 40/70/100 Pole, E27.....	554
VAP SLIM 30/60/90 Pole, E27.....	554
VARU EL.....	462, 705
VARU EL, QPAR51.....	462, 705
VERLUX EL, square, TRIAC.....	512, 513
VILUA L WL.....	649
VILUA S WL.....	648
VILUA UP/DOWN, WL.....	649
VINCELLI D PD, TRIAC.....	053
VINCELLI D TL.....	012
VINCELLI D WL.....	223
VISSARDO WL.....	210

W

WALLYX WL, QPAR51.....	635
WAVE 25 WL.....	171
WAVE 45 WL.....	171
WETSY EL, square/round.....	719
WILRON L SP.....	607
WILRON S SP.....	607
WL 106 E14.....	213
WL 149 WL.....	163
WL 149 WL, QT-DE12.....	163
WORKLIGHT FL.....	030
WORKLIGHT PD, DALI.....	120
WORKLIGHT PLUS FL, DALI.....	031
WORKLIGHT PLUS PD, DALI.....	121
WORO EL.....	445

Y

YOKI EASYTEC® II, QPAR111.....	412
--------------------------------	-----

Z

Zubehör

1-10V Dimmer 10W.....	849
4-Fach Gartensteckdose.....	862, 863
Bewegungsmelder Infrarot.....	865
DALI Controller 24V DC.....	849
DALI Interface 0-10V + on/off.....	849
DALI Universal Dimmer 3-25W.....	849
DALI Universal Dimmer 10-300W.....	849
Deckenhaken.....	858
Deckenrosette.....	859
Doppelseitiges Klebeband.....	861
Drahtseilabhangung.....	859
Energie-Pack 230V.....	864
GU10 Fassung.....	860
GU10 Fassung	
mit Anschlussbox und Schnellklemme.....	860
Kabel.....	859
Kabelklemme.....	858
Kabelverlangerung.....	860, 861
KOMPENSATIONSMODUL.....	852

LED Netzteil 12V/24V DC 12W.....	850
LED Netzteil 12V/24V DC 12W rund.....	850
LED Netzteil 12V/24V DC 20W.....	850
LED Netzteil 24V 100W.....	850, 851
LED Netzteil 24V 50W.....	851
LED Netzteil 24V DC 100W.....	850, 851
LED Netzteil 24V DC 150W.....	851
LED Netzteil 24V DC 20W.....	851
LED Netzteil 24V DC 36W.....	850
LED Netzteil 24V DC 60W.....	850
LED Treiber 320mA 3W.....	856
LED Treiber 350mA 10W.....	852
LED Treiber 350mA 15W.....	852
LED Treiber 350mA 3W.....	856
LED Treiber 350mA 6W.....	852
LED Treiber 350mA 9W.....	856
LED Treiber 350mA inkl. Zulentlastung.....	856
LED Treiber 500mA 15W.....	852
LED Treiber 500mA 9W.....	856
LED Treiber 700mA	
10W inkl. Zulentlastung.....	853
LED Treiber 700mA	
11W inkl. Zulentlastung.....	857
LED Treiber 700mA	
3W inkl. Zulentlastung.....	857
LED Treiber 700mA	
40W inkl. Zulentlastung.....	853
LED Treiber 700mA	
40W inkl. Zulentlastung.....	857
LED Treiber 1000mA.....	853
LED Treiber 1000mA	
40W inkl. Zulentlastung.....	857
LED Treiber 1050mA	
40W inkl. Zulentlastung.....	853
LED Treiber 700mA 6W.....	852
LED Treiber DALI 250-700mA 20W.....	855
LED Treiber DALI 250-700mA 40W.....	855
LED Treiber DALI 350-1050mA 60W.....	855
LED Treiber DALI 700-1500mA 50W.....	855
LED Treiber VALETO® 1050mA.....	857
PWM-Wandler 12V DC / 24V DC.....	849
Rohrkit Nepro Display.....	861
SLV Kabel H05RN-F.....	865
SLV Kabel H07RN-F.....	865
SLV VALETO® 12/24V Strip	
Steuermodul CCT.....	848
SLV VALETO® 12/24V Strip	
Steuermodul RGBW.....	848
SLV VALETO® 15W, LED Treiber.....	853
Steckerleiste 3 Ausgange.....	860, 861
Steckerleiste 6 Ausgange.....	860, 861
Stopper fur Drahtseil.....	859
T-Verbindertbox.....	864, 865
Textilkabel 3-polig, 3 x 0,75 mm², 10 m.....	859
Textilkabel 3-polig, 3 x 0,75 mm², 5 m.....	859
Transformator 12V AC 10VA IP44.....	846
Transformator 12V AC 60VA.....	848
Transformator 12V AC 60VA.....	848
Transformator 12V AC 60VA IP44.....	846
Transformator 12V AC 105VA.....	846
Transformator 12V AC 150VA.....	848
Transformator 12V AC 210VA.....	848
Transformator 12V AC 300VA.....	846
Transformator TENSEO 12V AC 50VA.....	847
Transformator TENSEO 12V AC 105VA.....	847
Transformator TENSEO 12V AC 210VA.....	847
TRIAC LED Treiber 700mA	
39W inkl. Zulentlastung.....	853
Verbindertbox.....	864
Verbindertbox 4-fach.....	864

1003007 79



1003003 79



NEW
PANTILO

1003005 79



1002873 57

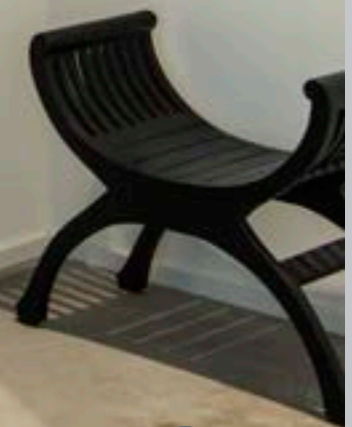

**NEW
VARIANT**
PARA CONE

NEW
DASAR®



1002893 733

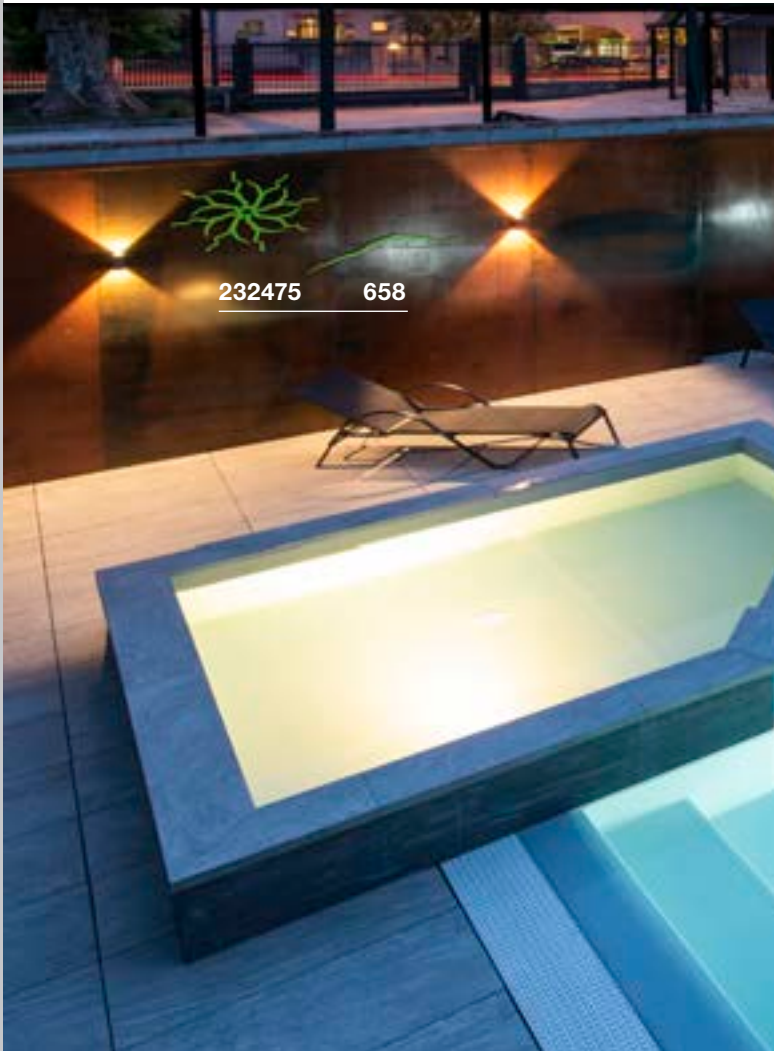

232475 658

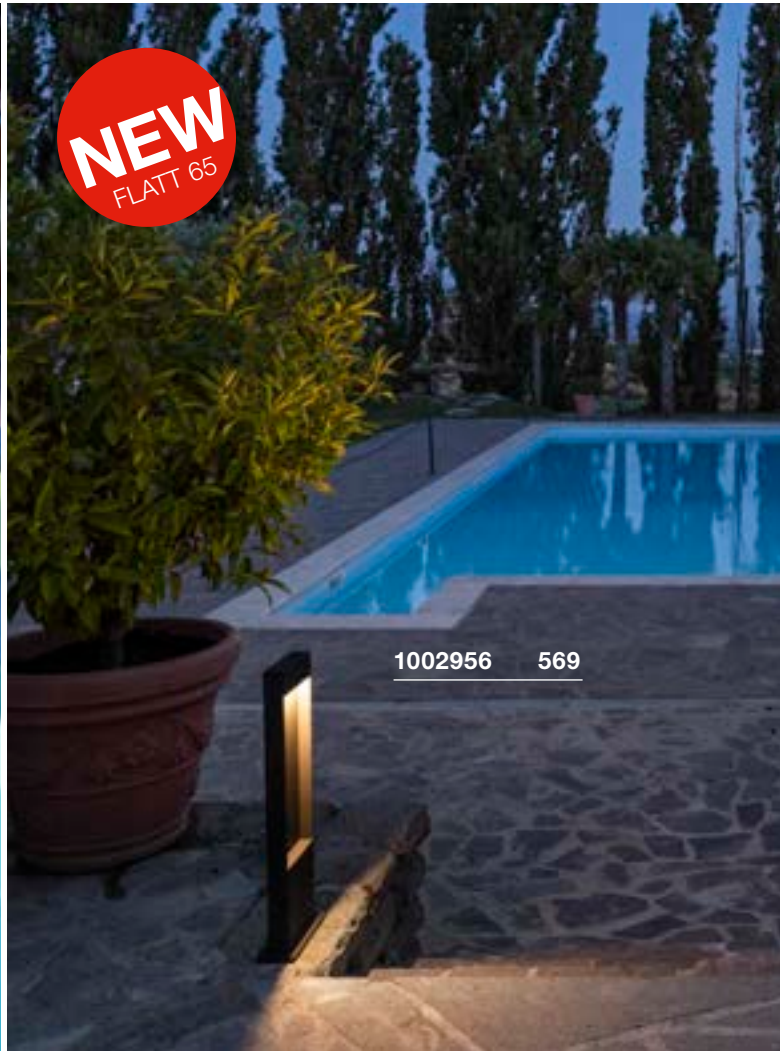

NEW
FLATT 65

1002956 569

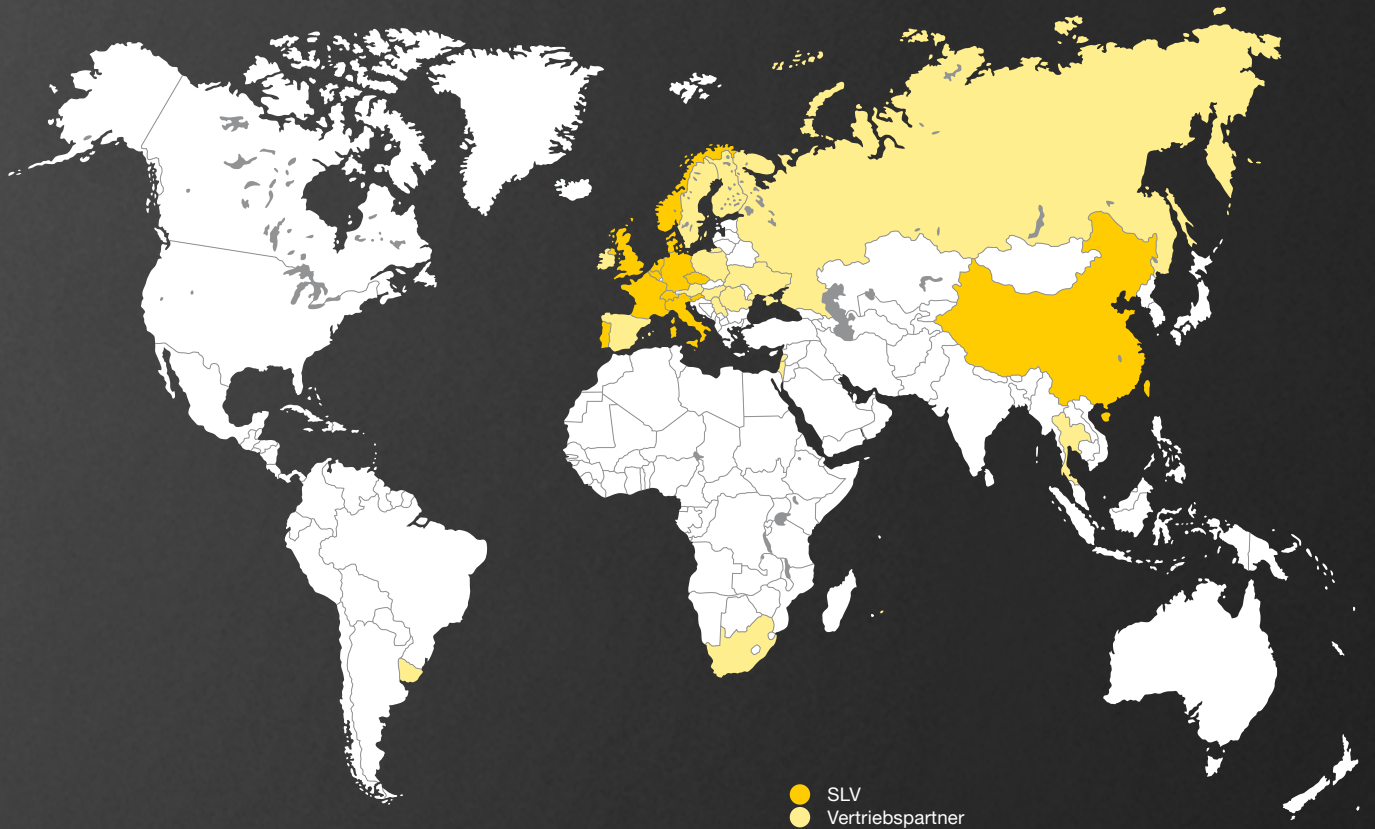

16

TOCHTER-
GESELLSCHAFTEN

19

VERTRIEBS-
PARTNER

SLV BELIEFERT MEHR
ALS 100 LÄNDER

WIR SIND IN
IHRER NÄHE.

TOCHTERGESELLSCHAFTEN

- Asien
- Belgien
- Dänemark
- Frankreich
- Großbritannien
- Italien
- Niederlande
- Norwegen
- Portugal
- Schweiz
- Slowenien
- Tschechische Republik

VERTRIEBSPARTNER

- Dänemark
- Finnland
- Irland
- Israel
- Libanon
- Malta
- Mauritius
- Österreich
- Polen
- Rumänien
- Russland
- Schweden
- Serbien
- Spanien
- Südafrika
- Thailand
- Ukraine
- Ungarn
- Uruguay

KUNDENINFORMATIONEN

Hinweise zur Hitzeentwicklung am Leuchtgehäuse

Halogenleuchtmittel haben eine hohe Betriebstemperatur und können zur Aufheizung des jeweiligen Leuchtgehäuses führen. Letzteres darf daher nur im abgekühlten Zustand berührt werden. Verstellbare Leuchten bzw. Leuchtenköpfe, die nicht über isolierte Verstellgriffe verfügen oder die bei Betrieb mit der maximalen Leuchtmittelleistung die maximal zulässige Gehäusetemperatur an der offensichtlichen Verstellstelle übersteigen, sind zudem außerhalb des Handbereichs zu montieren. Als Niedrigtemperatur-Alternative sind zu den meisten unserer Halogenleuchten LED-Retrofit-Leuchtmittel erhältlich.

Lichtstrom

Die Gesamtlichtmenge, die von einer Lichtquelle erzeugt wird, wird in Lumen (lm) angegeben.

Lichtstärke

Die Lichtstärke ist der pro Raumwinkel angegebene Lichtstrom und wird in Candela (cd) angegeben.

Farbwiedergabeindex

Die Farbwiedergabeeigenschaft einer Lichtquelle wird mit dem Ra Index (englisch Color Rendering Index) beschrieben. Bei in Innenräumen eingesetzten Lichtquellen ist ein CRI von 80 oder höher vorgeschrieben. Lichtquellen für den Außenbereich müssen einen CRI von mindestens 65 aufweisen.

Lichtfarbe

Die Lichtfarbe einer Lichtquelle wird in K (Kelvin) angegeben.

Standard-LED

Dies ist die klassische Ausführung der LED (3 mm oder 5 mm LED). Diese wurden ursprünglich für Indikationszwecke, z. B. in Instrumententafeln, entwickelt.

Standard SMD LED

SMD bedeutet „Surface Mounted Device“ (oberflächenmontierbares Bauteil). Sie ist eine kompakte LED, die ohne Drahtanschlüsse direkt auf die Leiterplatte aufgelötet wird. Die SMD ist in verschiedenen Größen erhältlich und bietet eine gute Eignung für Beleuchtungszwecke.

PowerLED

PowerLED ist eine leistungsstarke LED mit einer Leistung von 1W und mehr. Sie stellt erhöhte Anforderungen an die Stromkonstanz und sollte daher grundsätzlich mit Konstantstromquellen betrieben werden. Sofern mehrere Leuchtdioden angeschlossen werden sollen, müssen diese daher in Reihe geschaltet werden. Eine Parallelschaltung ist unzulässig. Bitte beachten Sie zudem die Installationsreihenfolge, um die LEDs nicht kurzzeitig zu hohem Strom auszusetzen und sie damit zu beschädigen. Grundsätzlich gilt: Erst den Sekundärstromkreis (LEDs an Treiber) vollständig anschließen, danach den Primärstromkreis (Treiber an Stromquelle) schließen.

Chip On Board LED (COB LED); Flächen-LED

Hier handelt es sich um eine LED in extrem flacher Bauform. Vorteil der COB LED ist eine gute Wärmeableitung bei technischer Umsetzung mit Kühlflächen, wodurch eine hohe Lichtausbeute und eine hohe Lebensdauer möglich sind.

Edelstahl 304

(1.4301) Eine gute Korrosionsbeständigkeit zeigt sich in natürlichen Umweltmedien (Wasser, städtische und ländliche Atmosphäre) bei Abwesenheit von bedeutenden Chlor- und Salzkonzentrationen. 1.4301 ist jedoch weder für Einsatzgebiete, in denen es zum Kontakt mit Meer- bzw. Salzwasser oder salzhaltiger Atmosphäre kommt, noch für den Einsatz in Schwimmbädern oder ähnlichem geeignet.

Edelstahl 316

(1.4404) In natürlichen Umweltmedien (Wasser, städtische und ländliche Atmosphäre) sowie in Industriegebieten mit mäßiger Chlor- und Salzkonzentration, im Bereich der Lebensmittel- und Pharmaindustrie und auf dem landwirtschaftlichen Nahrungsmittelsektor weist 1.4404 eine ausgezeichnete Korrosionsbeständigkeit auf. 1.4404 ist nicht meerwasserbeständig.

Bitte beachten Sie:

Ein großer Teil der in diesem Katalog vorgestellten Produkte ist durch Warenzeichen, Geschmacksmuster, Gebrauchsmuster oder Patente geschützt. Ein Verstoß gegen diese Schutzrechte oder eine Verwendung von Text- und Layoutgestaltung sowie urheberrechtlich geschützten Bildern ohne unsere Genehmigung wird gerichtlich verfolgt. Die in diesem Katalog enthaltenen Abbildungen und Angaben dienen nur der Veranschaulichung und sind unverbindlich in Farbe, Form, Ausführung und technischen Daten. Bei sämtlichen Produktbeschreibungen/-angaben bleiben Änderungen und Irrtümer daher vorbehalten.

Alle Produkte unseres Sortiments unterliegen einer strengen Qualitätssicherung und erfüllen die allgemein gültigen Normen. Dieser Katalog beinhaltet ein allgemeines Sortiment und ist nicht landesspezifisch ausgelegt. Etwaige Abweichungen von landesspezifischen Vorgaben sind vor der Bestellung zu klären. SLV haftet nicht für gegebenenfalls abweichende technische Normen.

Alle Gewichts- und Längenangaben sind in kg bzw. in cm angegeben, sofern nicht anders bezeichnet. Technische Änderungen vorbehalten!

Die Präsentation unserer Leuchten mit realistischen und beispielhaften Anwendungsfotos wird ermöglicht durch das freundliche Entgegenkommen und die Zustimmung der Eigentümer oder Gestalter der jeweils vordergründig in den Bildern zu sehenden Umgebungen. All jenen, die durch ihr Einverständnis zur Entstehung und Verwendung unserer Fotos beigetragen haben, sei an dieser Stelle nochmals herzlich gedankt!

Mit Erscheinen dieses Katalogs sind die Preise in den bisher erschienenen Listen und Katalogen ungültig.

Herausgeber

SLV GmbH, Deutschland
Daimlerstraße 21-23
52531 Übach-Palenberg
T +49 (0) 2451 4833-0
slv.com

Copyright

© SLV GmbH, 2019

Bildnachweise

SLV GmbH
Externe Fotografen: Andreas Fein, Anja Lynen, Gerd Arnolds,
Günther Preissler, Marc Derkum, Dirk Hoffmann



Beim Druck dieses Produkts wurde durch den innovativen Einsatz der Kraft-Wärme-Kopplung im Vergleich zum herkömmlichen Energieeinsatz bis zu 52% weniger CO₂ emittiert.

EcoVadis

EcoVadis ist eine renommierte Ratingagentur, die die unternehmerische Verantwortung bewertet. Mit der sogenannten CSR-Bewertungsmethode (Corporate Social Responsibility) werden insgesamt 150 Einkaufskategorien und 21 CSR-Indikatoren unter die Lupe genommen. Dabei betrachtet die Ratingagentur nicht nur Umweltaspekte, sondern auch die Einhaltung von Arbeits- und Menschenrechten sowie Ethik und nachhaltige Beschaffung. Seit der Gründung im Jahre 2007 ist EcoVadis zu einem geschätzten und anerkannten Partner für Einkaufsorganisationen in mehr als 300 weltweit führenden multinationalen Unternehmen geworden. SLV zählt mit seinem Ergebnis branchenübergreifend zu den Top 5 % aller weltweit am Assessment teilnehmenden Unternehmen und sogar zu den Top 2 % seiner Branche.

PRODUKTEIGENSCHAFTEN

	Energieeffizienzklasse „Diese Leuchte ist geeignet für Leuchtmittel der Energieeffizienzklassen ...“
	Leuchten mit eingebauten LEDs „Diese Leuchte enthält eingebaute LED-Lampen. Die Lampen können in der Leuchte nicht ausgetauscht werden.“ (s. EU-Verordnung 874/2012)
	„Diese Leuchte enthält eingebaute LED-Lampen. Die Lampen können in der Leuchte nicht ausgetauscht werden.“ (s. EU-Verordnung 874/2012) <i>Hinweis für den Endnutzer:</i> Die Lichtquelle dieser Leuchte darf nur vom Hersteller oder einem von ihm beauftragten Servicetechniker ersetzt werden.
	Energieeffizienzindex des Vorschaltgeräts
	Dimmbar mit ... <ul style="list-style-type: none"> · C = Phasenabschnittsdimmer · L = Phasenanschnittsdimmer · Uni = Universaldimmer · Triac C = Triac Phasenabschnittsdimmer · Triac L = Triac Phasenanschnittsdimmer · 1–10 V · DALI = DALI Bussystem · Switch = Schalter bzw. Taster
	Gewicht des Produkts in kg
	Dreh- und Schwenkbarkeit: Leuchte <ul style="list-style-type: none"> · Drehbereich · Schwenkbereich
	Dreh- und Schwenkbarkeit: Leuchtmittel/Leuchenteil <ul style="list-style-type: none"> · Schwenkbereich
	Der Halbstreuwinkel , auch Ausstrahlungswinkel genannt, wird zur Kennzeichnung der Bündelung von Licht verwendet. Je kleiner der Wert desto größer ist die Bündelung.
	Lichtaustritt <ul style="list-style-type: none"> · direkt · direkt-indirekt · Beam · Flood und Beam
	Pendelkabellänge bei Pendelleuchten in cm
	Netzkabellänge in cm Zuleitungslänge in cm (mit offenem Kabelende)
	Maximaler Seilabstand bei Niedervolt-Seilsystemen in cm
	Mittlere Lebensdauer eines Leuchtmittels bzw. einer Lichtquelle in Stunden
	Eine Lichtverteilungskurve zum betreffenden Produkt senden wir Ihnen auf Anfrage gern zu.
	Reflektorlampen Direktspiegellampen (no cool beam): Wärmebelastung im Lichtbündel, dafür kaum Wärmestrahlung an der Reflektorrückseite
	Kennzeichnet mit Fernbedienung steuerbare Produkte

SPEZIFISCHE ANGABEN – EINBAULEUCHTEN

	Form der Einbauöffnung
	Hitzeentwicklung an der Oberfläche des Bodeneinbaustrahlers
	Gewichtsbelastbarkeit des Produkts bis zum angegebenen Wert in Tonnen. Messungen basieren auf Betoneinbau.

SICHERHEITSTECHNISCHE ANGABEN

	Schutzklasse Eins · Zwei · Drei
	Kurzschlussfestes Sicherheitsbetriebsgerät
	Schlagfestigkeit des Produkts bis zum angegebenen Wert in Joule
	Der IK-Stoßfestigkeitsgrad ist ein Maß für die Schutzarten durch Gehäuse für elektrische Betriebsmittel (Ausrüstung) gegen äußere Beanspruchungen (IK-Codes).

EINSATZBEREICH · MONTAGE

	Montagebereich <ul style="list-style-type: none"> · Wand · Decke · Boden · Wand/Decke · Wand/Boden · Decke/Boden · Wand/Decke/Boden
	<ul style="list-style-type: none"> · Einsatz ausschließlich für Innenräume · Ungeeignet für die Anwendung in Innenräumen · IP-Schutzart
	Erlaubt die Montage des Geräts auf Werkstoffen, deren Entflammverhalten nicht bekannt ist.
	Leuchtmittel geeignet für den Einsatz in Leuchten ... <ul style="list-style-type: none"> · mit Schutzglas · ohne Schutzglas
	Kabeldurchmesser in mm
	Durchverdrahtung ... <ul style="list-style-type: none"> · möglich · bis zur angegebenen Leuchtenanzahl möglich.
	Unabhängiger Konverter (Betriebsgerät auch zur Verwendung außerhalb von Leuchten)

BESONDERE SYMBOLE

	Kennzeichnet Produkte mit eingebauten LEDs
	Smart Home kompatibel <ul style="list-style-type: none"> · SLV VALETO Modul integriert · SLV VALETO Fähigkeit mit Zubehör
	Kennzeichnet erstmalig in den Katalog aufgenommene Produkte.
	Kennzeichnet neue Varianten bestehender Produkte <ul style="list-style-type: none"> · Neue Farbvariante · Neue Produktvariante · Nachfolger
	Kennzeichnet Leuchten mit Bewegungsmelder (Mikrowellen (MR)-Technik / Infrarot / Funk)
	Dim to warm Je mehr Dimmung, desto wärmer die Lichtfarbe.
	<ul style="list-style-type: none"> · USB-Ladefunktion · Induktive (kabellose) Ladefunktion für Smartphones
	Kennzeichnet unsere Leuchtmittel HighLIGHTS
	Kennzeichnet Produkte, die nach Geschmack und Ambiente individuell kombinierbar sind.
	Leuchten sind nach Grundierung individuell mit Wandfarbe überstreichbar/tapezierbar.
	Kennzeichnet Profile, die auf Kundenwunsch in individuellen Längen und komplett bestückt bestellt werden können.



ERLEBE LICHT

SLV GmbH

Daimlerstraße 21-23
52531 Übach-Palenberg
Deutschland

T +49 (0) 2451 4833 - 333

F +49 (0) 2451 4188 - 0

F +49 (0) 2451 4188 - 8

info@slv.de

slv.com