

NEWS20

#madeinathens

BR//GHT[®]
SPECIAL LIGHTING

ABOUTUS

Bright was founded in 1989 and our head quarters are located in Greece. We are the leading manufacturer of architectural lighting systems in Europe. Our success lies on the deep knowledge of the lighting technology, unique personal designing style and amply of efficient manufacturing, distributing and lighting systems for more than 50 years.

Bright Special Lighting strategy is based on detailed planning and designing, aiming at the most satisfying operational result. The quality and endurance of our products have achieved to satisfy the highest European standards.

OPTIO
SPOT

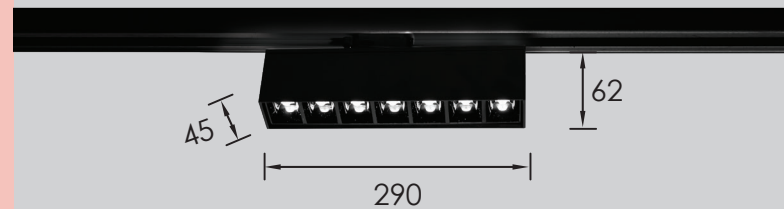
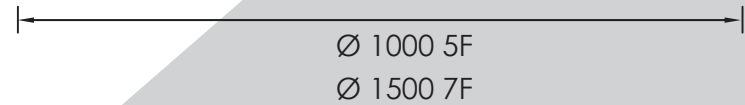
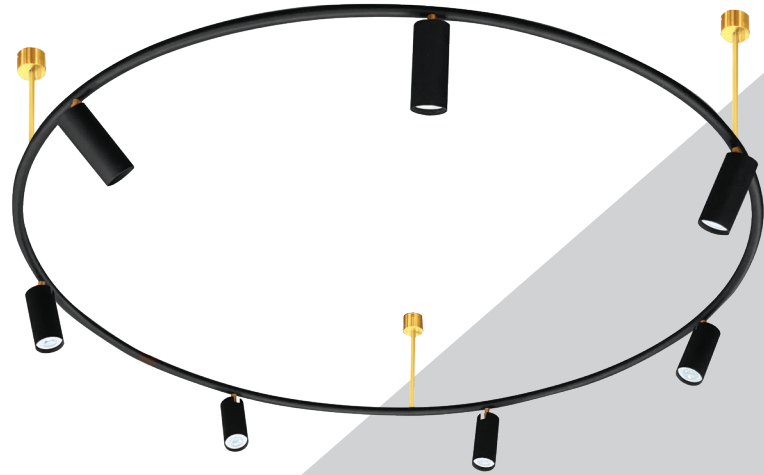

NOTUS 25
LINEAR LVD

LEGATUS

MAGNETIC 48V
TRACK SYSTEM

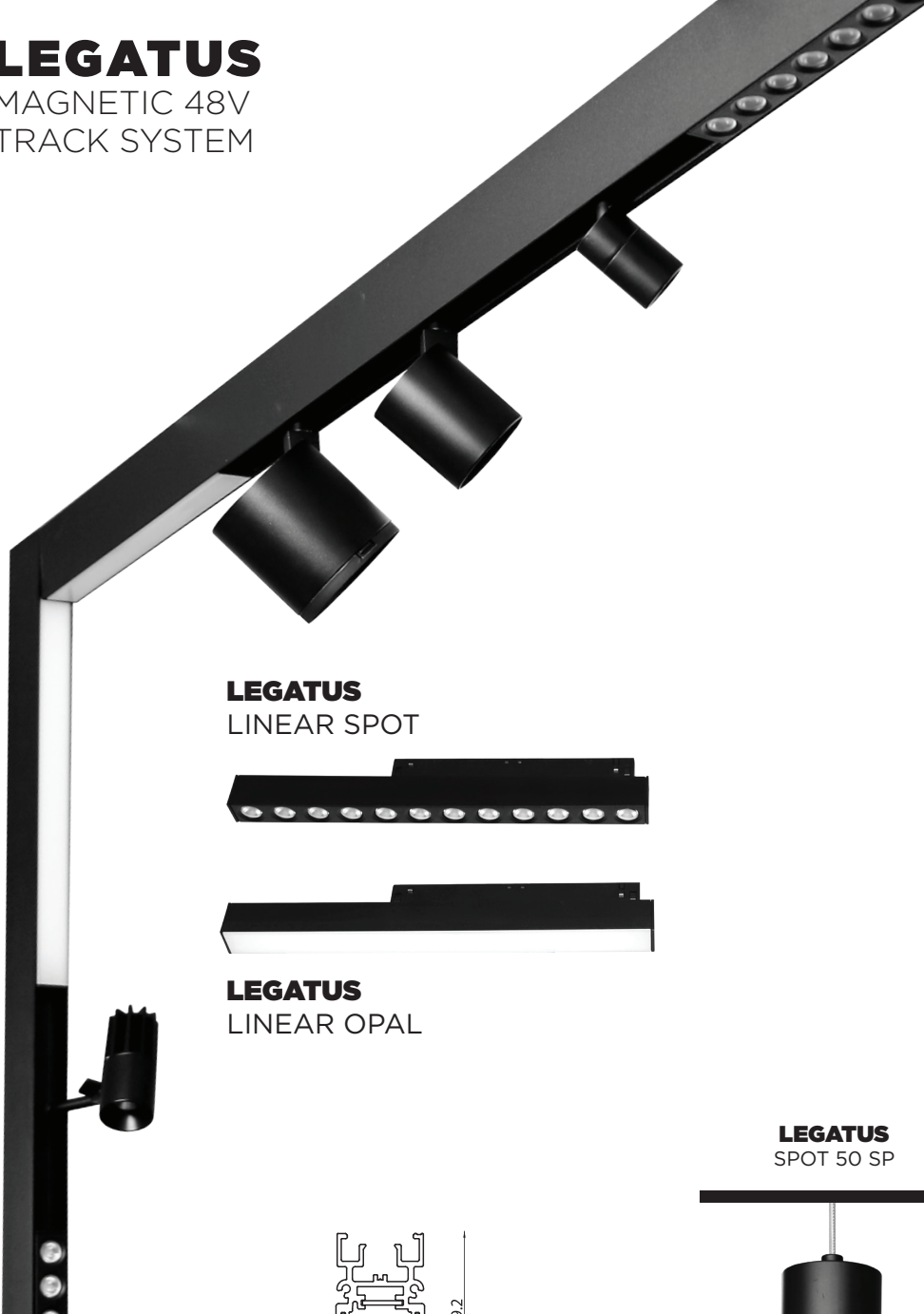

LEGATUS
LINEAR SPOT



LEGATUS
LINEAR OPAL

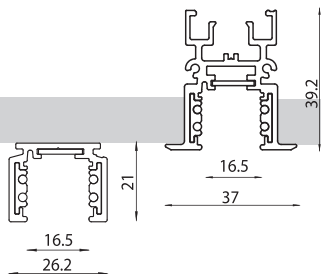

LEGATUS
SPOT 80



LEGATUS
SPOT 50



LEGATUS
SPOT 25



LEGATUS
FUSUS

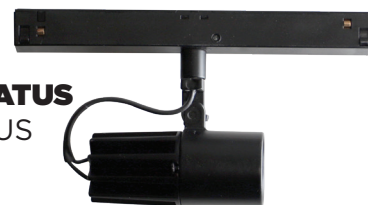

LEGATUS
SPOT 50 SP

LEGATUS
SPOT 25 SP

LEGATUS
ROTO 4 SP

LEGATUS
AVOLO XS SP



POTIS

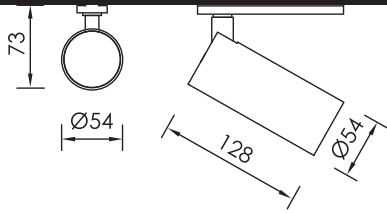

POTIS S

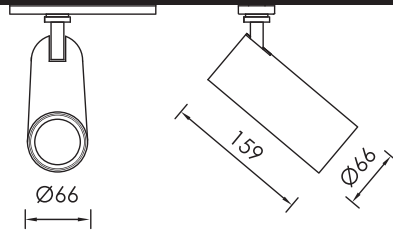

POTIS N

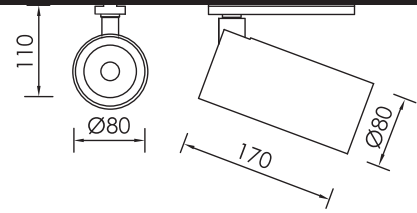

POTIS M



STATUR



STATUR
SMALL



STATUR

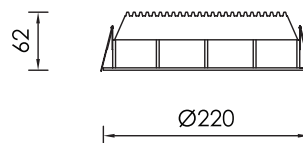
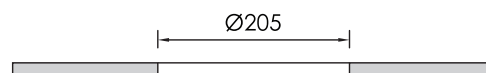
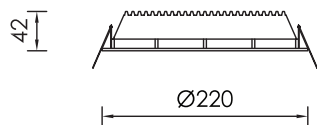
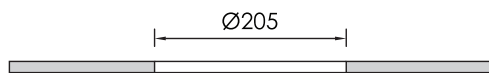



FAMA
OUT FOCUS

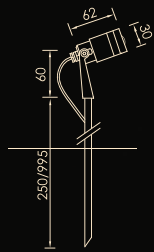

FAMA
OUT SPOT

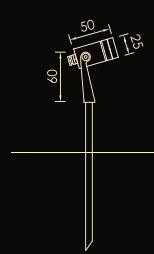

FAMA S



FAMA

FAMA S
STEPS 1



FAMA
STEPS 1

FAMA S
STEPS 2

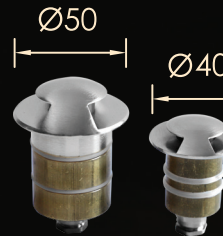

FAMA
STEPS 2

TALIS 1
CURVE

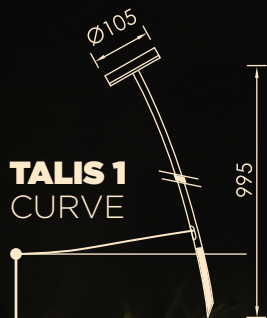

VISO 1 / 2



NOTUS

LINEAR LED
STONE



NOTUS 14
LINEAR LED
STONE

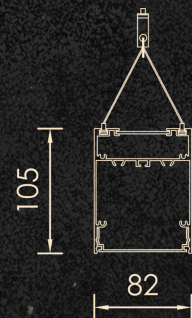

NOTUS 16
LINEAR LED
STONE



NOTUS STONE TEXTURES

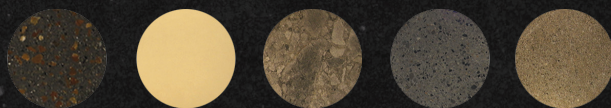

LATER

STONE



Ø 200
300
400



200x200
300x300
400x400



200x200
300x300
400x400

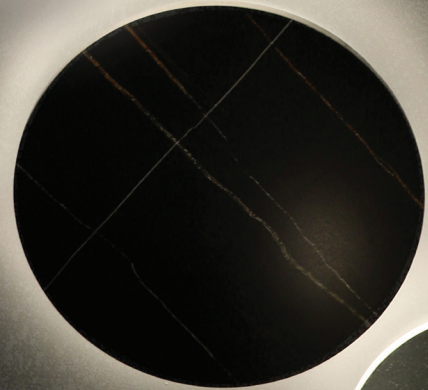
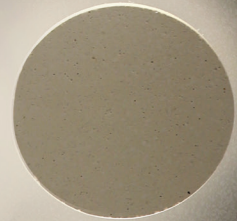
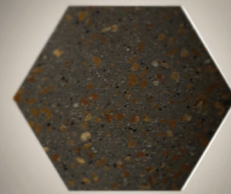
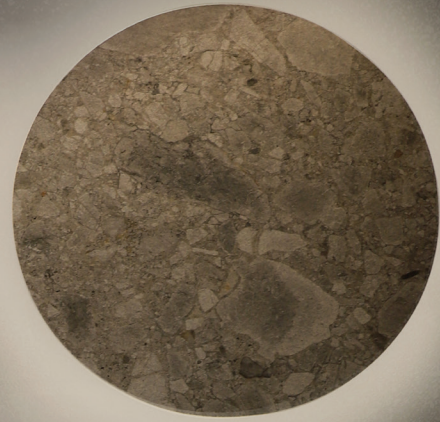

45

ROTO

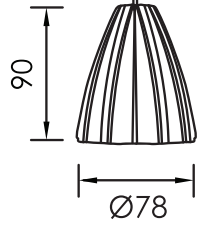

ROTO 2

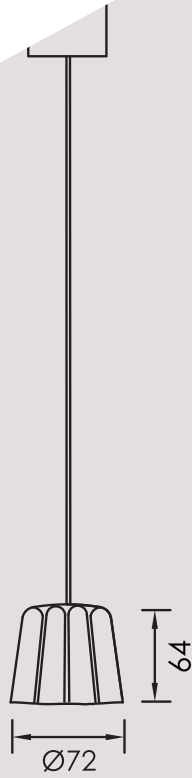

ROTO 4



NINIO S

CEILING

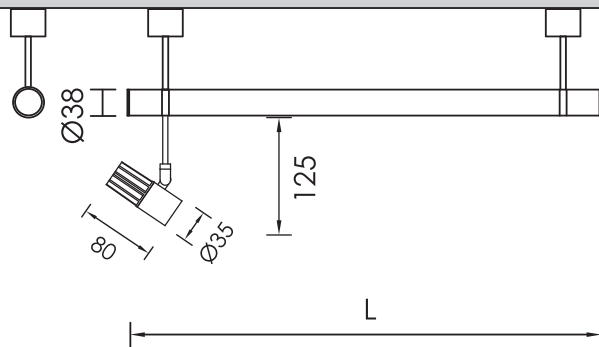

L max : 2000mm

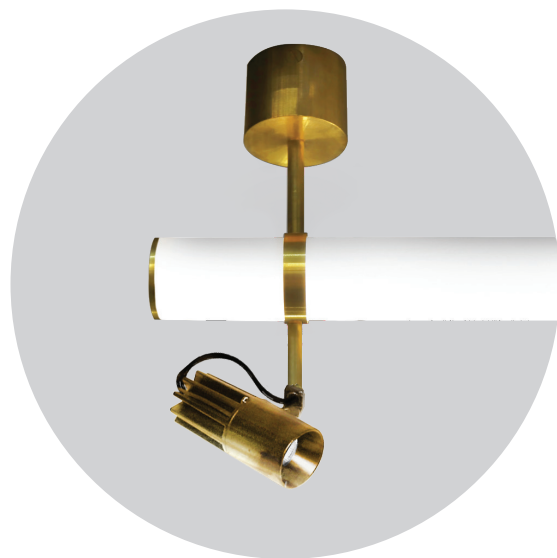

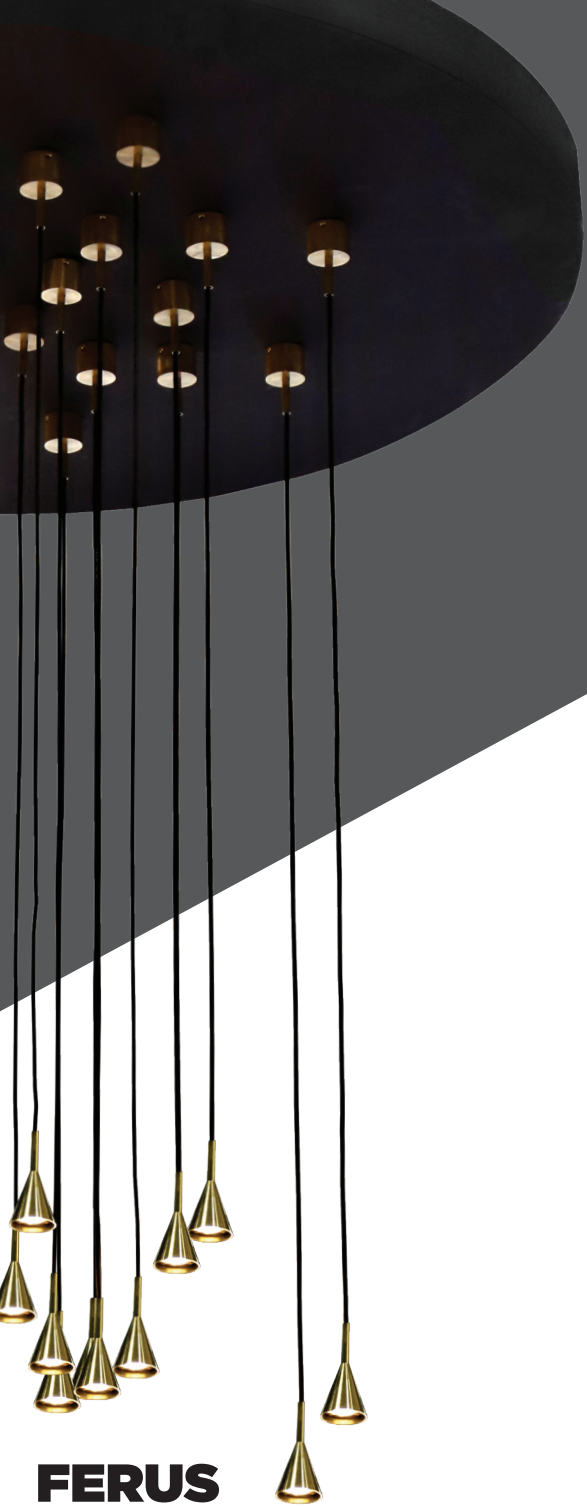

FERUS
SP

VISO 5
SP



VISO 4
SP



VISO 3
SP



VISO 2
SP MINI



VISO 1
SP

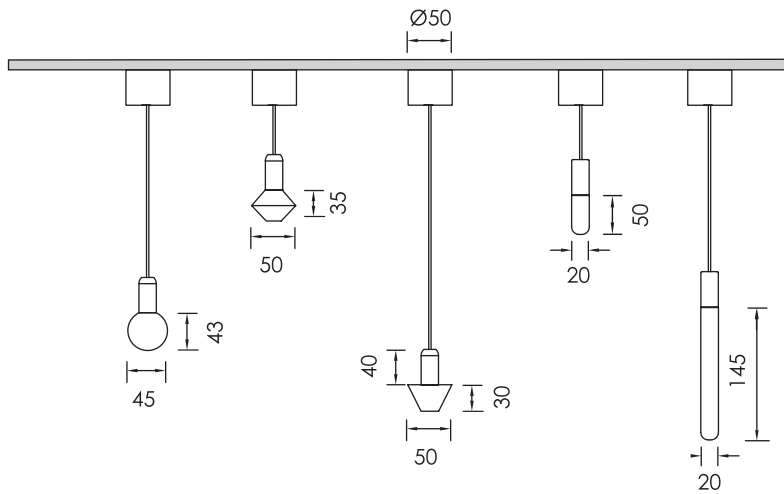

ARIES

CUP

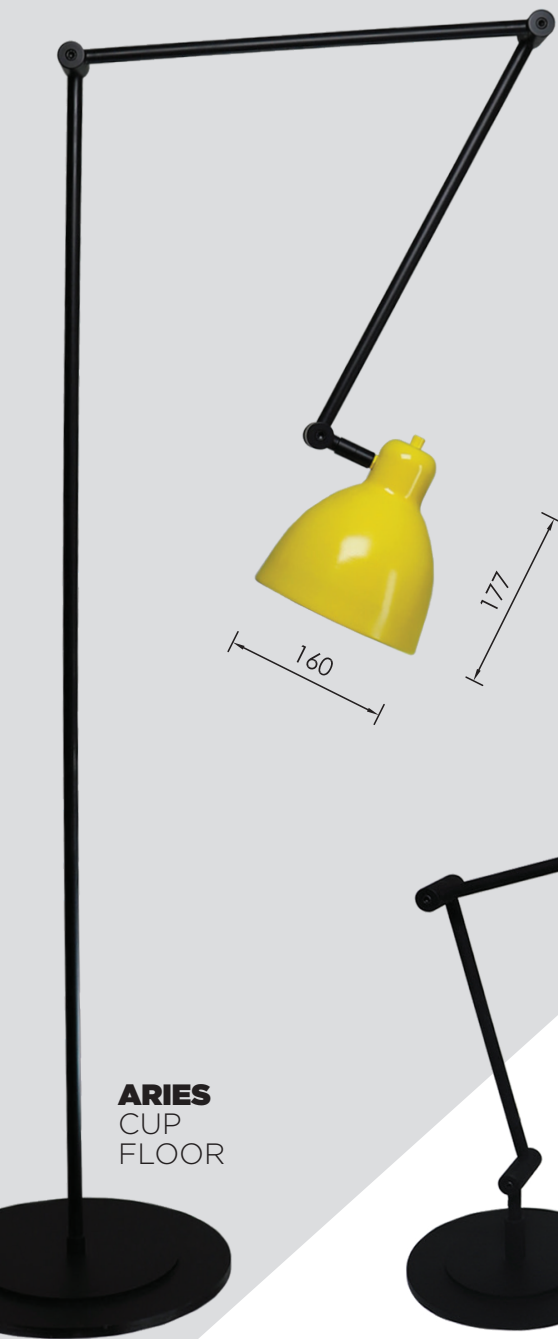

160

177



80

100



FIRMUS



FIRMUS

50



FIRMUS B

50



FIRMUS

30 SP

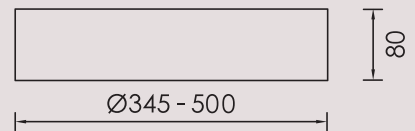

FIRMUS B

30

PENDO



PENDO
M3 CEILING



PENDO
M3F CEILING

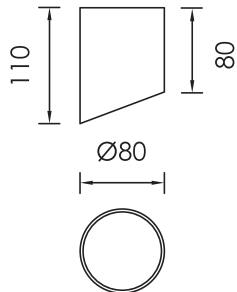
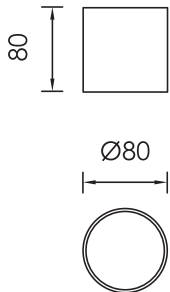

BR//GHT
SPECIAL LIGHTING

Headoffice / Showroom:

13 S. Venizelou Avenue, Likovrisi, P.O. Box 14123, Athens, Greece
Tel: (+30) 210 28 51 304 Fax: (+30) 210 28 51 306

Showroom:

3 Alimou Avenue, Alimos, P.O. Box 17455, Athens, Greece
Tel: (+30) 210 98 83 722 Fax: (+30) 210 98 83 726

Showroom:

119 Kifisias Avenue, Marousi, P.O. Box 15125, Athens, Greece
Tel: (+30) 210 80 64 181 Fax: (+30) 210 80 64 194

Showroom:

6 Kazantzidi Avenue, Iraklio, P.O. Box 71601, Crete, Greece
Tel: (+30) 2810 210 480 Fax: (+30) 2810 210 482

Showroom:

101 E. Adistaseos Avenue, Kalamaria, P.O. Box 55134, Thessaloniki, Greece
Tel: (+30) 2310 48 18 48 Fax: (+30) 2310 48 18 28

Factory - Financial Services:

5 Kefalovrisou Street, Monomati, Aharnai, P.O. Box 13677, Athens, Greece
Tel: (+30) 210 62 08 230 Fax: (+30) 210 62 08 262

Quality Management Laboratory:

5 Kefalovrisou Street, Monomati, Aharnai, P.O. Box 13677, Athens, Greece
Tel: (+30) 210 62 08 230 Fax: (+30) 210 62 08 262

www.bright.gr | info@bright.gr

BR//GHT[®]
SPECIAL LIGHTING

www.bright.gr | info@bright.gr